



FLAT GAIN, HIGH DYNAMIC RANGE

Monolithic Amplifier

PGA-122-75+

Mini-Circuits

75Ω 5 to 1500 MHz

THE BIG DEAL

- High IP3, +43 dBm typ. at 0.5 GHz
- Gain, 15.6 dB typ. at 0.5 GHz
- High P_{OUT}, P1dB +73.1 dBmV typ. at 0.5 GHz
- Low Noise Figure, 2.9 dB at 0.5 GHz
- Usable over 5-2000 MHz

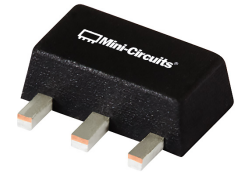

Generic photo used for illustration purposes only

CASE STYLE: DF782

APPLICATIONS

- CATV, DOCSIS 3.1
- GPON
- MOCA
- DBS

+RoHS Compliant

The +Suffix identifies RoHS Compliance. See our website for methodologies and qualifications

PRODUCT OVERVIEW

PGA-122-75+ (RoHS compliant) is an advanced wideband amplifier fabricated using E-PHEMT technology and offers extremely high dynamic range over a broad frequency range with low noise figure and flat gain. Lead finish is SnAgNi. It has repeatable performance from lot to lot and is enclosed in a SOT-89 package for very good thermal performance.

KEY FEATURES

Feature	Advantages
Broad Band: 0.04 to 1.5 GHz	0.04 to 1.5 GHz bandwidth covers primary CATV applications such as DOCSIS 3.1
Application circuit for 5 to 2000 MHz available	Supports bandwidth requirements for upstream CATV applications. See application note AN-60-087. Recommend Evaluation Board, TB-885+
High IP3 Versus DC power Consumption: +43 dBm typical at 0.5 GHz	The PGA-122-75+ matches industry leading IP3 performance relative to device size and power consumption. The combination of the design and E-PHEMPT structure provides enhanced linearity over a broad frequency range as evidence in the IP3 being typically 15-20 dB above the P 1dB point. This feature makes this amplifier ideal for use in CATV applications.
High IP2, +54 dBm at 0.5 GHz	Suppresses second order product on wideband applications such as CATV
Low Noise Figure, 2.9 dB at 0.5 GHz	Low noise figure performance in combination with the high output IP3 results in high dynamic range.
Excellent CSO/CTB* CSO, -59 dBc CTB, -80 dBc Measured at channel 78	Competitive performance at lower current and supply voltage.

*78 channels flat, 30 dBmV/channel at output, 6 MHz channel spacing.

REV. A
ECO-011959
PGA-122-75+
MCL NY
240807





FLAT GAIN, HIGH DYNAMIC RANGE

Monolithic Amplifier

PGA-122-75+

Mini-Circuits

75Ω 5 to 1500 MHz

ELECTRICAL SPECIFICATIONS¹ AT +25°C, 75Ω AND +9V UNLESS NOTED OTHERWISE

Parameter	Condition (GHz)	Vd=+9V			Vd=+8V	Units
		Min.	Typ.	Max.	Typ.	
Frequency Range		0.04		1.5	0.04-1.5	GHz
Gain	0.04	—	15.5	—	15.5	dB
	0.5	—	15.6	—	15.6	
	1.0	14.0	15.5	17.1	15.5	
	1.25	—	15.4	—	15.3	
	1.5	—	15.1	—	15.0	
Gain Flatness Over	0.04-1.25		±0.1		±0.1	dB
Input Return Loss	0.04		17.8		17.6	dB
	0.5		21.2		20.8	
	1.0		18.7		18.0	
	1.25		16.1		15.9	
	1.5		14.2		13.8	
Output Return Loss	0.04		19.8		20.2	dB
	0.5		24.3		24.1	
	1.0		16.4		16.7	
	1.25		13.0		13.0	
	1.5		10.0		9.8	
Reverse Isolation	1.0		21.0		21.0	dB
Output Power @1dB Compression	0.04		23.4 (72.2)		22.4 (71.2)	dBm (dBmV)
	0.5		24.3 (73.1)		23.3 (72.1)	
	1.0		23.8 (72.6)		23.1 (71.9)	
	1.25		23.3 (72.1)		22.3 (71.1)	
	1.5		22.8 (71.6)		21.6 (70.4)	
Output IP3	0.04		+43.3		+42.3	dBm
	0.5		+43.2		+43.6	
	1.0		+41.4		+39.9	
	1.25		+38.8		+37.0	
	1.5		+37.9		+35.4	
Output IP2 ²	0.04		+59.5		+56.9	dBm
	0.5		+54.9		+53.0	
	1.0		+58.5		+57.5	
	1.25		+52.2		+50.1	
	1.5		+49.4		+47.2	
Noise Figure	0.04		2.9		3.0	dB
	0.5		2.9		2.8	
	1.0		2.8		2.9	
	1.25		3.0		2.9	
	1.5		3.0		3.2	
Device operating voltage		+8.5	+9.0	+9.5	+8.0	V
Device operating current		—	115	140	102	mA
Device current variation vs temperature ⁴			22		25	μA/°C
Device current variation vs voltage			0.0146		0.0146	mA/mV
Thermal resistance, junction-to-ground lead ³			30		30	°C/W

1. Measured on Mini-Circuits Characterization Eval board TB-859+. See Characterization Test Circuit (Fig. 1)
2. Output IP2 measured at sum frequency of the two tones (f meas= f1+f2).
3. Junction to ground lead.
4. (Current at 85°C - Current at -45°C)/130

ABSOLUTE MAXIMUM RATINGS⁵

Parameter	Ratings
Operating Temperature (ground lead)	-40°C to +85°C
Storage Temperature	-65°C to +150°C
Operating Current at +9.0V	167 mA
Power Dissipation	1.5 W
Input Power (CW)	+20 dBm over 40-1200 MHz, and +24 dBm over 1200-1500 MHz (5 minutes) +17 dBm over 40-1200 MHz, and +20 dBm over 1200-1500 MHz (continuous)
DC Voltage on Pin 3	+11 V

5. Permanent damage may occur if any of these limits are exceeded. Electrical maximum ratings are not intended for continuous normal operation.





FLAT GAIN, HIGH DYNAMIC RANGE

Monolithic Amplifier

PGA-122-75+

Mini-Circuits

75Ω 5 to 1500 MHz

SIMPLIFIED SCHEMATIC AND PIN DESCRIPTION

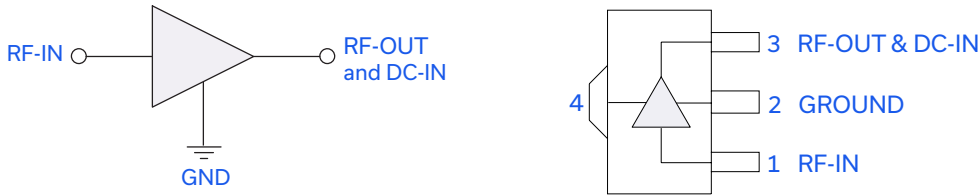

Function	Pin Number	Description
RF-IN	1	RF input pin. This pin requires the use of an external DC blocking capacitor chosen for the frequency of operation.
RF-OUT and DC-IN	3	RF output and bias pin. DC voltage is present on this pin; therefore a DC blocking capacitor is necessary for proper operation. An RF choke is needed to feed DC bias without loss of RF signal due to the bias connection, as shown in "Recommended Application Circuit", Fig. 2
GND	2,4	Connections to ground. Use via holes as shown in "Suggested Layout for PCB Design" to reduce ground path inductance for best performance.

*Enhanced mode pseudomorphic High Electron Mobility Transistor.



FLAT GAIN, HIGH DYNAMIC RANGE

Monolithic Amplifier

PGA-122-75+

Mini-Circuits

75Ω 5 to 1500 MHz

CHARACTERIZATION TEST CIRCUIT

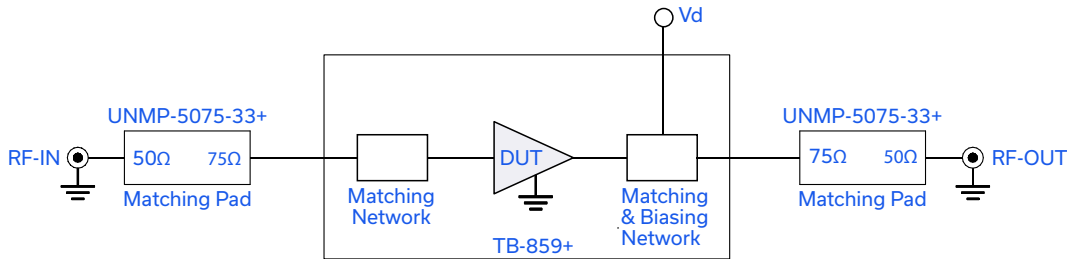
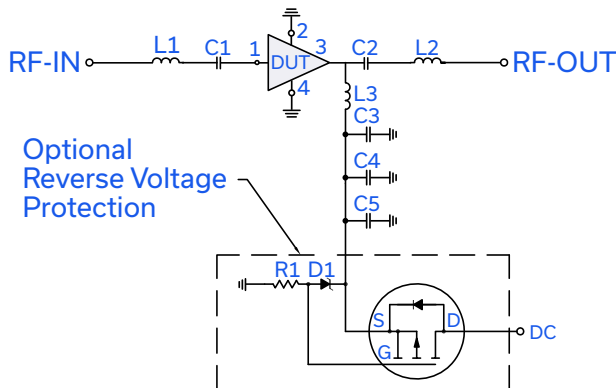

Fig 1. Block Diagram of Test Circuit used for characterization. (DUT tested on Mini-Circuits Characterization Eval board TB-859+) Gain, Return loss, Output power at 1dB compression (P1 dB), output IP3 (OIP3), output IP2 (OIP2) and noise figure measured using Agilent's N5242A PNA-X microwave network analyzer.

Conditions:

1. Gain and Return loss: $P_{IN} = -25\text{dBm}$
2. Output IP3 (OIP3): Two tones, spaced 1 MHz apart, 5 dBm/tone at output.
3. Output IP2 (OIP2): Two tones, spaced 11 MHz apart, 5 dBm/tone at output.

RECOMMENDED APPLICATION CIRCUIT (TB-850+)



COMPONENT	VALUE	SIZE
DUT	PGA-122-75+	-
C1	1000 pF	0402
C2	120 pF	
C3	100 pF	
C4	10000 pF	1206
C5	10 uF, 25V	
D1	Zener Diode 5.6V ONSEMI MMSZ4690T1G	SOD123
L1	3.3 nH	0402
L2	4.7 nH	0603
L3	560 nH	
R1	1.5 kOhm	SOT323
Q1	Transistor ONSEMI FET NTS4101P	

Fig 2. Evaluation board includes case, connectors, and components soldered to PCB
Note: R1, D3 and Q1 are for reverse voltage protection and may be omitted.

PRODUCT MARKING

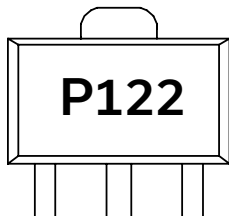

Marking may contain other features or characters for internal lot control

Mini-Circuits



FLAT GAIN, HIGH DYNAMIC RANGE

Monolithic Amplifier

PGA-122-75+

Mini-Circuits

75Ω 5 to 1500 MHz

ADDITIONAL DETAILED TECHNICAL INFORMATION IS AVAILABLE ON OUR DASHBOARD. [CLICK HERE](#)

Performance Data	Data Table Swept Graphs S-Parameter (S2P Files) Data Set (.zip file)
5-200 MHz Operation	See Application Note AN-60-087
Case Style	DF782 (SOT 89) Plastic package, exposed paddle lead finish: tin-silver over nickel
Tape & Reel Standard quantities available on reel	F55
Suggested Layout for PCB Design	PL-477
Evaluation Board	TB-850+ (40-1500 MHz) TB-885+ (5-20 MHz)
Environmental Ratings	ENV08T1

ESD RATING

Human Body Model (HBM): Class 1A (250<500) in accordance with ANSI/ESD STM 5.1 - 2001
Machine Model (MM): Class class M1 (25V) in accordance with ANSI/ESD STM5.2-1999

MSL RATING

Moisture Sensitivity: MSL1 in accordance with IPC/JEDEC J-STD-020D

- NOTES**
- A. Performance and quality attributes and conditions not expressly stated in this specification document are intended to be excluded and do not form a part of this specification document.
 - B. Electrical specifications and performance data contained in this specification document are based on Mini-Circuit's applicable established test performance criteria and measurement instructions.
 - C. The parts covered by this specification document are subject to Mini-Circuits standard limited warranty and terms and conditions (collectively, "Standard Terms"); Purchasers of this part are entitled to the rights and benefits contained therein. For a full statement of the standard. Terms and the exclusive rights and remedies thereunder, please visit Mini-Circuits' website at www.minicircuits.com/MCLStore/terms.jsp



Typical Performance Data

Definitions:

Input Return Loss = -S11 (dB)

Gain(Power Gain) = S21 (dB)

Reverse Isolation = -S12 (dB)

Output Return Loss = -S22 (dB)

TEST CONDITIONS: Vd = 9.00V, Id = 114.41mA @ Temperature = +25°C

FREQ	Gain	Isolation	Input Return Loss	Output Return Loss	Stability		IP-3 Output	1dB Comp. Output	Noise Figure
					K	Measure			
(MHz)	(dB)	(dB)	(dB)	(dB)	K	Measure	(dBm)	(dBm)	(dB)
10	9.71	27.39	2.64	1.30	1.15	0.22	26.75	17.42	4.76
20	14.74	21.71	9.71	8.19	1.18	0.63	43.59	21.80	3.18
30	15.36	20.95	14.82	15.61	1.18	0.71	52.22	22.89	3.06
40	15.52	20.81	18.13	21.43	1.18	0.71	46.14	23.35	3.01
50	15.47	20.84	19.98	25.57	1.19	0.71	45.18	23.44	2.95
60	15.55	20.75	20.24	30.16	1.18	0.70	47.16	23.69	2.93
70	15.57	20.70	20.72	31.76	1.17	0.70	44.76	23.76	2.94
80	15.58	20.68	20.87	31.41	1.17	0.70	42.46	23.86	2.84
90	15.58	20.69	20.82	30.45	1.17	0.70	43.57	23.91	2.79
100	15.57	20.68	20.80	29.53	1.17	0.70	43.01	23.94	2.77
150	15.59	20.64	20.92	27.35	1.17	0.69	42.03	23.99	2.72
200	15.58	20.62	21.29	26.47	1.17	0.69	42.74	24.02	2.76
250	15.59	20.64	21.45	26.27	1.17	0.69	42.62	24.15	2.75
300	15.59	20.63	21.16	25.88	1.17	0.69	43.82	24.20	2.78
350	15.60	20.64	21.05	25.59	1.17	0.69	45.13	24.31	2.81
400	15.60	20.66	21.31	25.37	1.17	0.69	45.76	24.29	2.80
450	15.60	20.68	21.06	24.99	1.17	0.69	49.10	24.35	2.77
500	15.61	20.69	21.21	24.69	1.17	0.69	44.87	24.40	2.83
550	15.60	20.72	20.96	24.17	1.17	0.69	45.90	24.40	2.82
600	15.61	20.74	20.88	23.61	1.17	0.69	49.30	24.39	2.89
650	15.61	20.77	20.72	23.01	1.18	0.69	49.13	24.44	2.90
700	15.61	20.81	20.50	22.39	1.18	0.69	50.64	24.38	2.96
750	15.61	20.84	20.11	21.72	1.18	0.70	44.64	24.43	2.88
800	15.59	20.89	19.80	20.98	1.18	0.70	50.53	24.42	2.88
850	15.60	20.92	19.38	20.13	1.18	0.70	45.10	24.31	2.91
900	15.60	20.96	18.99	19.24	1.18	0.70	44.74	24.31	2.85
950	15.59	20.99	18.69	18.35	1.18	0.70	42.36	24.23	2.93
1000	15.58	21.03	18.28	17.48	1.19	0.70	43.58	24.14	2.93
1050	15.56	21.08	17.86	16.67	1.19	0.70	43.49	23.96	3.02
1100	15.54	21.13	17.41	15.81	1.19	0.70	42.95	23.86	2.88
1150	15.52	21.20	17.01	14.99	1.19	0.70	40.61	23.67	3.00
1200	15.49	21.26	16.50	14.24	1.20	0.69	40.53	23.56	2.94
1250	15.45	21.33	16.08	13.51	1.20	0.69	39.78	23.38	2.89
1300	15.41	21.40	15.68	12.78	1.20	0.69	39.51	23.34	2.92
1350	15.36	21.49	15.23	12.10	1.20	0.69	38.76	23.18	2.88
1400	15.30	21.57	14.80	11.41	1.21	0.68	39.18	23.03	3.00
1450	15.24	21.66	14.37	10.77	1.21	0.68	39.10	22.88	3.05
1500	15.17	21.77	13.93	10.14	1.21	0.67	38.67	22.72	2.98
1550	15.10	21.86	13.55	9.55	1.21	0.67	37.98	22.02	3.08
1600	15.01	21.98	13.15	8.97	1.21	0.66	38.06	22.48	2.95
1700	14.82	22.22	12.35	7.94	1.22	0.64	37.43	22.42	3.05
1800	14.60	22.50	11.46	7.00	1.22	0.62	36.94	21.98	3.13
1900	14.33	22.82	10.64	6.11	1.22	0.60	35.89	21.41	3.19
2000	14.01	23.17	9.67	5.33	1.21	0.57	35.06	20.80	3.25

Typical Performance Data

Definitions:

Input Return Loss = -S11 (dB)

Gain(Power Gain) = S21 (dB)

Reverse Isolation = -S12 (dB)

Output Return Loss = -S22 (dB)

TEST CONDITIONS: Vd = 8.50V, Id = 107.16mA @ Temperature = +25°C

FREQ	Gain	Isolation	Input Return Loss	Output Return Loss	Stability		IP-3 Output	1dB Comp. Output	Noise Figure
					K	Measure			
(MHz)	(dB)	(dB)	(dB)	(dB)	K	Measure	(dBm)	(dBm)	(dB)
10	9.60	27.35	3.03	1.30	1.17	0.21	26.58	16.93	4.60
20	14.72	21.72	9.43	8.19	1.19	0.64	40.86	21.33	3.16
30	15.34	20.96	15.32	15.63	1.18	0.71	46.97	22.41	3.01
40	15.49	20.79	18.47	21.49	1.18	0.71	47.55	22.87	2.98
50	15.43	20.69	20.71	25.69	1.18	0.71	45.82	22.97	2.90
60	15.53	20.73	20.27	30.21	1.18	0.70	44.94	23.22	2.86
70	15.54	20.68	20.92	31.62	1.17	0.70	43.88	23.29	2.83
80	15.55	20.66	21.14	31.22	1.17	0.70	42.79	23.39	2.77
90	15.55	20.67	20.70	30.23	1.17	0.70	42.55	23.44	2.77
100	15.55	20.65	20.68	29.33	1.17	0.70	42.12	23.47	2.79
150	15.56	20.63	20.83	27.18	1.17	0.69	42.80	23.50	2.70
200	15.55	20.61	21.07	26.32	1.17	0.69	42.38	23.53	2.71
250	15.56	20.62	21.35	26.07	1.17	0.69	43.02	23.64	2.74
300	15.56	20.62	21.08	25.68	1.17	0.69	46.37	23.69	2.75
350	15.57	20.63	20.91	25.36	1.17	0.69	42.97	23.80	2.80
400	15.58	20.65	21.17	25.14	1.17	0.69	45.17	23.78	2.79
450	15.58	20.67	21.03	24.73	1.17	0.69	50.59	23.84	2.76
500	15.58	20.69	21.01	24.43	1.17	0.69	45.89	23.88	2.78
550	15.57	20.71	20.78	23.89	1.17	0.69	46.42	23.88	2.86
600	15.58	20.74	20.74	23.33	1.18	0.69	49.57	23.87	2.86
650	15.58	20.76	20.54	22.72	1.18	0.69	43.84	23.92	2.91
700	15.58	20.80	20.31	22.09	1.18	0.70	46.18	23.86	2.92
750	15.58	20.84	20.04	21.42	1.18	0.70	44.03	23.92	2.87
800	15.56	20.88	19.65	20.68	1.18	0.70	44.80	23.91	2.87
850	15.57	20.92	19.25	19.85	1.18	0.70	43.19	23.80	2.86
900	15.56	20.95	18.90	18.97	1.19	0.70	43.25	23.80	2.84
950	15.56	20.99	18.59	18.09	1.19	0.70	41.41	23.72	2.89
1000	15.55	21.04	18.16	17.23	1.19	0.70	42.36	23.63	2.85
1050	15.53	21.09	17.74	16.44	1.19	0.70	42.75	23.45	3.01
1100	15.50	21.14	17.34	15.59	1.19	0.70	41.40	23.35	2.94
1150	15.48	21.20	16.98	14.79	1.19	0.70	39.66	23.16	2.96
1200	15.45	21.27	16.44	14.04	1.20	0.70	39.58	23.04	2.92
1250	15.40	21.33	15.99	13.33	1.20	0.69	38.64	22.86	2.91
1300	15.36	21.41	15.59	12.61	1.20	0.69	38.44	22.81	2.94
1350	15.31	21.49	15.13	11.93	1.21	0.69	37.93	22.65	2.85
1400	15.25	21.59	14.73	11.26	1.21	0.68	38.22	22.51	2.98
1450	15.19	21.68	14.27	10.62	1.21	0.68	37.68	22.35	3.08
1500	15.11	21.79	13.89	10.00	1.21	0.67	37.55	22.20	2.94
1550	15.04	21.88	13.52	9.42	1.21	0.67	36.76	21.77	3.07
1600	14.95	22.00	13.04	8.85	1.22	0.66	36.99	21.97	2.95
1700	14.75	22.24	12.29	7.84	1.22	0.64	36.33	21.90	2.97
1800	14.52	22.52	11.48	6.91	1.22	0.62	35.62	21.45	3.07
1900	14.25	22.85	10.65	6.04	1.22	0.60	34.75	20.88	3.17
2000	13.93	23.20	9.60	5.27	1.21	0.57	34.10	20.26	3.15

Typical Performance Data

Definitions:

Input Return Loss = -S11 (dB)

Gain(Power Gain) = S21 (dB)

Reverse Isolation = -S12 (dB)

Output Return Loss = -S22 (dB)

TEST CONDITIONS: Vd = 9.50V, Id = 121.59mA @ Temperature = +25°C

FREQ	Gain	Isolation	Input Return Loss	Output Return Loss	Stability		IP-3 Output	1dB Comp. Output	Noise Figure
					K	Measure			
(MHz)	(dB)	(dB)	(dB)	(dB)	K	Measure	(dBm)	(dBm)	(dB)
10	9.67	27.05	2.92	1.32	1.15	0.21	27.05	17.86	4.70
20	14.77	21.76	9.40	8.18	1.18	0.64	43.37	22.25	3.23
30	15.38	20.95	15.10	15.60	1.18	0.70	44.20	23.32	3.06
40	15.54	20.82	18.54	21.39	1.18	0.70	53.16	23.79	3.02
50	15.48	20.74	21.78	25.51	1.18	0.70	45.22	23.89	2.95
60	15.57	20.70	20.64	30.17	1.17	0.70	47.85	24.14	2.94
70	15.60	20.71	21.01	31.81	1.17	0.70	48.32	24.21	2.90
80	15.60	20.69	21.28	31.57	1.17	0.69	44.44	24.31	2.87
90	15.60	20.70	21.01	30.61	1.17	0.69	43.29	24.36	2.80
100	15.60	20.68	20.99	29.71	1.17	0.69	43.44	24.39	2.81
150	15.61	20.65	20.90	27.53	1.17	0.69	44.15	24.44	2.76
200	15.60	20.62	21.30	26.67	1.17	0.69	43.89	24.48	2.74
250	15.61	20.65	21.62	26.44	1.17	0.69	43.63	24.61	2.78
300	15.62	20.64	21.55	26.05	1.17	0.69	43.43	24.67	2.75
350	15.62	20.65	21.46	25.74	1.17	0.69	44.01	24.78	2.84
400	15.63	20.66	21.38	25.58	1.17	0.69	47.20	24.77	2.84
450	15.63	20.69	21.34	25.18	1.17	0.69	45.09	24.83	2.81
500	15.63	20.70	21.34	24.93	1.17	0.69	44.91	24.88	2.85
550	15.62	20.72	21.11	24.40	1.17	0.69	47.58	24.86	2.87
600	15.63	20.75	21.12	23.86	1.17	0.69	50.54	24.86	2.83
650	15.63	20.77	20.82	23.26	1.17	0.69	46.70	24.91	2.90
700	15.64	20.81	20.60	22.65	1.18	0.69	49.61	24.85	2.93
750	15.63	20.85	20.28	21.97	1.18	0.69	48.07	24.90	2.91
800	15.62	20.89	19.88	21.22	1.18	0.70	49.65	24.90	2.90
850	15.62	20.92	19.49	20.36	1.18	0.70	46.98	24.79	2.92
900	15.63	20.96	19.09	19.46	1.18	0.70	47.02	24.78	2.90
950	15.62	20.99	18.76	18.56	1.18	0.70	44.85	24.70	2.94
1000	15.62	21.03	18.38	17.68	1.18	0.70	45.52	24.61	2.92
1050	15.60	21.08	17.95	16.87	1.19	0.70	46.65	24.43	3.08
1100	15.58	21.13	17.47	16.00	1.19	0.70	43.67	24.33	2.94
1150	15.56	21.20	17.10	15.17	1.19	0.69	42.18	24.14	3.00
1200	15.53	21.25	16.58	14.41	1.19	0.69	42.01	24.03	2.93
1250	15.49	21.32	16.11	13.67	1.20	0.69	40.58	23.86	2.87
1300	15.45	21.39	15.71	12.93	1.20	0.69	40.37	23.81	2.93
1350	15.40	21.47	15.27	12.23	1.20	0.69	40.01	23.66	2.89
1400	15.34	21.56	14.86	11.54	1.20	0.68	39.96	23.51	3.02
1450	15.29	21.65	14.40	10.88	1.21	0.68	39.85	23.36	3.07
1500	15.22	21.76	13.97	10.25	1.21	0.67	39.69	23.20	2.99
1550	15.16	21.85	13.58	9.66	1.21	0.66	39.04	22.28	3.09
1600	15.06	21.96	13.15	9.07	1.21	0.66	38.96	22.96	2.96
1700	14.88	22.20	12.40	8.03	1.21	0.64	38.25	22.90	3.04
1800	14.66	22.48	11.53	7.07	1.22	0.62	37.91	22.45	3.13
1900	14.39	22.81	10.65	6.17	1.21	0.59	37.02	21.89	3.14
2000	14.08	23.15	9.64	5.38	1.21	0.57	36.17	21.27	3.18

Typical Performance Data

Definitions:

Input Return Loss = -S11 (dB)

Gain(Power Gain) = S21 (dB)

Reverse Isolation = -S12 (dB)

Output Return Loss = -S22 (dB)

TEST CONDITIONS: Vd = 8.00V, Id = 99.96mA @ Temperature = +25°C

FREQ	Gain	Isolation	Input Return Loss	Output Return Loss	Stability		IP-3 Output	1dB Comp. Output	Noise Figure
					K	Measure			
(MHz)	(dB)	(dB)	(dB)	(dB)	K	Measure	(dBm)	(dBm)	(dB)
10	9.58	27.76	3.33	1.29	1.21	0.22	26.40	16.47	4.55
20	14.70	21.75	9.74	8.20	1.19	0.64	49.73	20.84	3.09
30	15.30	20.91	14.80	15.65	1.18	0.71	41.78	21.91	2.93
40	15.46	20.77	18.29	21.57	1.18	0.71	48.78	22.37	2.94
50	15.41	20.67	21.39	25.81	1.18	0.70	45.13	22.46	2.90
60	15.49	20.69	20.86	30.33	1.18	0.70	43.66	22.72	2.88
70	15.52	20.68	20.78	31.47	1.18	0.70	42.57	22.79	2.84
80	15.52	20.66	20.97	30.97	1.17	0.70	42.24	22.88	2.77
90	15.52	20.66	20.50	30.00	1.17	0.70	42.25	22.93	2.74
100	15.52	20.64	20.73	29.08	1.17	0.70	41.18	22.96	2.73
150	15.53	20.60	20.38	26.97	1.17	0.69	41.67	22.98	2.69
200	15.52	20.60	20.92	26.15	1.17	0.69	42.33	23.00	2.71
250	15.53	20.61	21.00	25.88	1.17	0.69	43.05	23.11	2.77
300	15.53	20.61	20.90	25.46	1.17	0.69	45.35	23.15	2.70
350	15.54	20.63	20.75	25.11	1.17	0.69	43.65	23.26	2.77
400	15.54	20.64	20.93	24.89	1.17	0.69	47.16	23.23	2.77
450	15.55	20.66	20.93	24.45	1.17	0.69	50.35	23.30	2.72
500	15.55	20.68	20.75	24.14	1.17	0.69	45.86	23.34	2.75
550	15.54	20.70	20.60	23.58	1.18	0.69	44.57	23.34	2.84
600	15.55	20.73	20.59	23.02	1.18	0.69	47.58	23.33	2.80
650	15.55	20.76	20.33	22.39	1.18	0.70	43.84	23.38	2.85
700	15.55	20.79	20.21	21.76	1.18	0.70	44.22	23.31	2.92
750	15.54	20.83	19.88	21.08	1.18	0.70	42.48	23.37	2.81
800	15.53	20.88	19.47	20.35	1.19	0.70	43.65	23.36	2.83
850	15.53	20.91	19.10	19.52	1.19	0.70	41.50	23.25	2.86
900	15.53	20.95	18.73	18.65	1.19	0.70	41.46	23.25	2.83
950	15.52	20.99	18.47	17.79	1.19	0.70	40.05	23.17	2.88
1000	15.50	21.04	18.02	16.95	1.19	0.70	42.61	23.08	2.86
1050	15.48	21.09	17.63	16.17	1.19	0.70	41.16	22.90	3.01
1100	15.45	21.14	17.25	15.34	1.19	0.70	39.84	22.80	2.91
1150	15.43	21.21	16.86	14.55	1.20	0.70	38.34	22.60	2.90
1200	15.39	21.27	16.28	13.82	1.20	0.70	38.33	22.48	2.86
1250	15.35	21.35	15.89	13.10	1.20	0.70	37.35	22.29	2.82
1300	15.30	21.43	15.51	12.40	1.21	0.69	37.25	22.24	2.92
1350	15.25	21.50	15.10	11.73	1.21	0.69	36.74	22.08	2.88
1400	15.18	21.60	14.73	11.07	1.21	0.69	36.94	21.94	2.99
1450	15.12	21.70	14.18	10.44	1.21	0.68	36.63	21.79	3.03
1500	15.05	21.81	13.81	9.84	1.22	0.67	36.39	21.63	2.97
1550	14.97	21.90	13.47	9.27	1.22	0.67	35.51	21.46	3.05
1600	14.87	22.02	13.05	8.71	1.22	0.66	35.58	21.40	2.93
1700	14.67	22.26	12.27	7.72	1.22	0.64	35.11	21.32	3.01
1800	14.43	22.55	11.44	6.80	1.22	0.62	34.49	20.87	3.10
1900	14.15	22.88	10.61	5.95	1.22	0.60	33.51	20.29	3.12
2000	13.83	23.24	9.59	5.20	1.22	0.57	32.79	19.68	3.21

Typical Performance Data

Definitions:

Input Return Loss = -S11 (dB)

Gain(Power Gain) = S21 (dB)

Reverse Isolation = -S12 (dB)

Output Return Loss = -S22 (dB)

TEST CONDITIONS: Vd = 7.00V, Id = 85.48mA @ Temperature = +25°C

FREQ	Gain	Isolation	Input Return Loss	Output Return Loss	Stability		IP-3 Output	1dB Comp. Output	Noise Figure
					K	Measure			
(MHz)	(dB)	(dB)	(dB)	(dB)	K	Measure	(dBm)	(dBm)	(dB)
10	9.45	27.36	3.15	1.30	1.19	0.22	26.92	15.44	4.55
20	14.60	21.68	9.67	8.20	1.19	0.64	37.94	19.75	3.02
30	15.22	20.88	14.95	15.73	1.18	0.71	53.71	20.82	2.86
40	15.38	20.73	18.21	21.74	1.18	0.71	43.96	21.27	2.86
50	15.33	20.75	19.22	26.08	1.19	0.72	42.45	21.36	2.82
60	15.41	20.62	20.69	30.28	1.18	0.70	41.21	21.61	2.84
70	15.43	20.62	20.13	31.13	1.18	0.70	41.10	21.68	2.76
80	15.43	20.61	20.38	30.44	1.18	0.70	40.59	21.76	2.77
90	15.44	20.62	20.27	29.41	1.18	0.70	39.47	21.81	2.68
100	15.43	20.60	20.18	28.52	1.18	0.70	40.18	21.83	2.72
150	15.44	20.58	19.95	26.46	1.17	0.70	39.71	21.83	2.63
200	15.44	20.56	20.45	25.64	1.17	0.69	39.73	21.84	2.70
250	15.45	20.57	20.65	25.31	1.17	0.69	39.95	21.93	2.69
300	15.45	20.58	20.42	24.86	1.17	0.69	42.48	21.95	2.72
350	15.46	20.60	20.47	24.46	1.17	0.69	43.58	22.06	2.75
400	15.46	20.61	20.47	24.18	1.17	0.69	45.39	22.02	2.75
450	15.46	20.63	20.36	23.69	1.18	0.69	44.93	22.09	2.71
500	15.46	20.65	20.32	23.33	1.18	0.70	43.14	22.13	2.77
550	15.45	20.69	20.13	22.73	1.18	0.70	41.90	22.14	2.78
600	15.46	20.71	20.12	22.15	1.18	0.70	41.83	22.11	2.81
650	15.46	20.74	19.89	21.49	1.18	0.70	40.12	22.17	2.81
700	15.46	20.78	19.68	20.85	1.18	0.70	40.31	22.09	2.89
750	15.44	20.82	19.38	20.17	1.19	0.70	38.93	22.14	2.82
800	15.43	20.87	19.06	19.45	1.19	0.71	39.32	22.13	2.78
850	15.42	20.92	18.65	18.64	1.19	0.71	38.49	22.01	2.84
900	15.42	20.96	18.34	17.81	1.19	0.71	38.21	22.00	2.82
950	15.41	21.00	18.09	16.98	1.19	0.71	37.07	21.92	2.86
1000	15.39	21.05	17.67	16.18	1.20	0.71	38.25	21.82	2.84
1050	15.36	21.10	17.31	15.43	1.20	0.70	37.11	21.65	2.95
1100	15.32	21.16	16.91	14.64	1.20	0.70	36.71	21.53	2.88
1150	15.30	21.24	16.59	13.88	1.20	0.70	35.49	21.31	2.93
1200	15.25	21.31	16.08	13.18	1.21	0.70	35.41	21.19	2.85
1250	15.20	21.38	15.64	12.51	1.21	0.70	34.67	20.99	2.81
1300	15.15	21.47	15.32	11.84	1.21	0.70	34.64	20.93	2.87
1350	15.08	21.55	14.86	11.20	1.22	0.69	34.14	20.77	2.79
1400	15.01	21.65	14.50	10.57	1.22	0.69	34.10	20.64	2.93
1450	14.94	21.75	14.11	9.97	1.22	0.68	33.86	20.49	2.97
1500	14.85	21.86	13.66	9.40	1.22	0.68	33.74	20.33	2.94
1550	14.77	21.97	13.36	8.85	1.23	0.67	32.89	20.18	2.96
1600	14.67	22.09	12.88	8.32	1.23	0.66	33.05	20.09	2.85
1700	14.44	22.35	12.16	7.38	1.23	0.64	32.48	20.00	2.98
1800	14.19	22.65	11.34	6.51	1.23	0.62	31.92	19.52	3.08
1900	13.89	22.97	10.52	5.70	1.23	0.60	31.09	18.93	3.04
2000	13.55	23.35	9.56	4.99	1.23	0.57	30.31	18.32	3.17

Typical Performance Data

Definitions:

Input Return Loss = -S11 (dB)

Gain(Power Gain) = S21 (dB)

Reverse Isolation = -S12 (dB)

Output Return Loss = -S22 (dB)

TEST CONDITIONS: Vd = 9.00V, Id = 112.77mA @ Temperature = -45°C

FREQ	Gain	Isolation	Input Return Loss	Output Return Loss	Stability		IP-3 Output	1dB Comp. Output	Noise Figure
					K	Measure			
(MHz)	(dB)	(dB)	(dB)	(dB)	K	Measure	(dBm)	(dBm)	(dB)
10	9.51	28.02	2.98	1.24	1.19	0.21	26.74	17.19	4.79
20	14.70	21.81	9.38	7.95	1.19	0.63	42.59	21.61	2.82
30	15.35	20.97	15.01	15.32	1.18	0.70	45.77	22.72	2.59
40	15.50	20.82	17.62	20.94	1.18	0.71	51.08	23.16	2.47
50	15.45	20.73	20.50	25.24	1.18	0.71	47.36	23.25	2.41
60	15.55	20.76	19.73	29.26	1.18	0.71	48.27	23.52	2.36
70	15.57	20.70	19.92	30.19	1.17	0.70	46.78	23.60	2.37
80	15.57	20.69	20.02	29.48	1.17	0.70	44.70	23.70	2.31
90	15.58	20.69	19.77	28.29	1.17	0.70	45.25	23.76	2.25
100	15.57	20.66	19.84	27.29	1.17	0.69	44.69	23.80	2.33
150	15.59	20.62	19.59	24.67	1.17	0.69	43.62	23.90	2.26
200	15.59	20.61	19.94	24.19	1.17	0.68	44.29	23.96	2.30
250	15.61	20.62	20.66	24.79	1.17	0.68	43.34	24.11	2.26
300	15.62	20.60	21.19	25.63	1.16	0.68	45.00	24.18	2.27
350	15.63	20.60	21.49	26.26	1.16	0.68	44.67	24.31	2.34
400	15.64	20.62	21.68	26.53	1.16	0.68	46.10	24.30	2.36
450	15.65	20.64	21.42	26.07	1.17	0.68	48.91	24.37	2.28
500	15.65	20.65	21.45	25.56	1.17	0.68	45.20	24.43	2.34
550	15.64	20.68	21.08	24.74	1.17	0.69	50.02	24.43	2.31
600	15.65	20.70	20.83	23.89	1.17	0.69	50.90	24.44	2.37
650	15.65	20.72	20.48	23.00	1.17	0.69	53.70	24.48	2.41
700	15.65	20.76	20.13	22.13	1.17	0.69	47.20	24.44	2.43
750	15.65	20.79	19.75	21.35	1.17	0.69	48.96	24.49	2.40
800	15.64	20.84	19.36	20.62	1.17	0.69	51.76	24.51	2.42
850	15.64	20.87	18.95	19.89	1.18	0.69	54.19	24.41	2.38
900	15.64	20.90	18.60	18.98	1.18	0.69	48.21	24.42	2.41
950	15.64	20.94	18.40	18.09	1.18	0.69	44.96	24.35	2.41
1000	15.64	20.97	18.07	17.17	1.18	0.69	46.31	24.26	2.38
1050	15.62	21.02	17.74	16.37	1.18	0.69	49.65	24.06	2.50
1100	15.60	21.06	17.36	15.54	1.18	0.69	48.52	23.99	2.41
1150	15.59	21.12	16.99	14.84	1.18	0.68	44.04	23.79	2.43
1200	15.56	21.18	16.53	14.17	1.18	0.68	43.62	23.69	2.45
1250	15.53	21.23	16.16	13.55	1.19	0.68	42.12	23.48	2.37
1300	15.50	21.30	15.73	12.87	1.19	0.68	41.83	23.41	2.42
1350	15.45	21.37	15.33	12.21	1.19	0.68	41.74	23.32	2.34
1400	15.40	21.46	14.89	11.54	1.19	0.67	42.25	23.17	2.47
1450	15.35	21.54	14.50	10.92	1.19	0.67	42.79	23.02	2.47
1500	15.29	21.63	14.14	10.33	1.20	0.66	41.67	22.85	2.50
1550	15.24	21.73	13.79	9.77	1.20	0.66	41.54	22.04	2.53
1600	15.16	21.82	13.42	9.21	1.20	0.65	41.69	22.57	2.47
1700	15.00	22.03	12.69	8.17	1.20	0.63	40.69	22.63	2.46
1800	14.80	22.28	12.00	7.18	1.20	0.61	41.06	22.34	2.56
1900	14.55	22.60	11.24	6.24	1.19	0.58	39.26	21.86	2.54
2000	14.25	22.94	10.27	5.42	1.19	0.55	38.33	21.33	2.62

Typical Performance Data

Definitions:

Input Return Loss = -S11 (dB)

Gain(Power Gain) = S21 (dB)

Reverse Isolation = -S12 (dB)

Output Return Loss = -S22 (dB)

TEST CONDITIONS: Vd = 8.50V, Id = 105.25mA @ Temperature = -45°C

FREQ	Gain	Isolation	Input Return Loss	Output Return Loss	Stability		IP-3 Output	1dB Comp. Output	Noise Figure
					K	Measure			
(MHz)	(dB)	(dB)	(dB)	(dB)	K	Measure	(dBm)	(dBm)	(dB)
10	9.46	27.92	3.18	1.24	1.20	0.21	26.46	16.78	4.70
20	14.67	21.78	9.41	7.93	1.19	0.63	44.64	21.13	2.77
30	15.32	20.94	14.67	15.32	1.18	0.71	50.41	22.24	2.51
40	15.47	20.82	17.66	20.98	1.18	0.71	45.44	22.69	2.40
50	15.42	20.69	18.46	25.23	1.18	0.71	47.21	22.78	2.39
60	15.51	20.71	19.55	29.14	1.18	0.70	51.59	23.05	2.36
70	15.54	20.68	19.75	29.92	1.17	0.70	47.03	23.12	2.33
80	15.54	20.67	19.86	29.20	1.17	0.70	43.33	23.22	2.27
90	15.55	20.68	19.52	28.08	1.17	0.70	44.26	23.28	2.27
100	15.54	20.66	19.76	27.09	1.17	0.70	43.52	23.32	2.24
150	15.56	20.62	19.13	24.50	1.17	0.69	43.40	23.42	2.24
200	15.56	20.59	19.91	24.05	1.17	0.69	43.19	23.48	2.26
250	15.58	20.60	20.68	24.63	1.17	0.68	43.87	23.62	2.25
300	15.59	20.59	20.99	25.43	1.17	0.68	43.41	23.69	2.23
350	15.60	20.60	21.17	26.05	1.17	0.68	44.35	23.81	2.30
400	15.61	20.61	21.57	26.30	1.17	0.68	45.21	23.80	2.31
450	15.61	20.62	21.49	25.85	1.17	0.68	44.84	23.86	2.28
500	15.62	20.64	21.26	25.32	1.17	0.68	45.73	23.92	2.31
550	15.61	20.66	20.88	24.53	1.17	0.69	46.45	23.93	2.35
600	15.62	20.68	20.72	23.69	1.17	0.69	48.20	23.92	2.40
650	15.62	20.71	20.29	22.81	1.17	0.69	48.78	23.98	2.39
700	15.62	20.74	20.00	21.95	1.17	0.69	47.73	23.92	2.46
750	15.62	20.78	19.65	21.19	1.17	0.69	49.68	23.98	2.37
800	15.60	20.83	19.29	20.47	1.18	0.69	52.29	23.99	2.42
850	15.60	20.86	18.79	19.74	1.18	0.69	52.30	23.89	2.36
900	15.61	20.89	18.52	18.84	1.18	0.69	47.46	23.90	2.35
950	15.61	20.92	18.26	17.96	1.18	0.69	45.95	23.83	2.42
1000	15.60	20.96	17.99	17.05	1.18	0.69	44.23	23.74	2.34
1050	15.59	21.00	17.63	16.26	1.18	0.69	48.53	23.54	2.48
1100	15.57	21.06	17.23	15.43	1.18	0.69	47.70	23.46	2.41
1150	15.55	21.12	16.97	14.74	1.18	0.69	43.49	23.26	2.46
1200	15.52	21.17	16.48	14.08	1.19	0.68	43.95	23.16	2.47
1250	15.49	21.23	16.00	13.46	1.19	0.68	41.41	22.94	2.33
1300	15.46	21.30	15.69	12.78	1.19	0.68	41.65	22.87	2.43
1350	15.41	21.37	15.23	12.13	1.19	0.68	41.19	22.77	2.36
1400	15.36	21.46	14.79	11.45	1.19	0.67	41.38	22.63	2.44
1450	15.31	21.54	14.41	10.85	1.20	0.67	41.26	22.48	2.50
1500	15.25	21.64	14.06	10.25	1.20	0.66	41.39	22.31	2.43
1550	15.19	21.72	13.74	9.71	1.20	0.66	40.30	21.74	2.51
1600	15.11	21.82	13.36	9.14	1.20	0.65	40.57	22.04	2.40
1700	14.95	22.04	12.64	8.11	1.20	0.63	39.74	22.09	2.47
1800	14.75	22.29	11.89	7.13	1.20	0.61	40.38	21.80	2.57
1900	14.49	22.59	11.15	6.20	1.19	0.58	38.84	21.31	2.53
2000	14.19	22.94	10.14	5.38	1.19	0.55	37.50	20.78	2.61

Typical Performance Data

Definitions:

Input Return Loss = -S11 (dB)

Gain(Power Gain) = S21 (dB)

Reverse Isolation = -S12 (dB)

Output Return Loss = -S22 (dB)

TEST CONDITIONS: Vd = 9.50V, Id = 120.14mA @ Temperature = -45°C

FREQ	Gain	Isolation	Input Return Loss	Output Return Loss	Stability		IP-3 Output	1dB Comp. Output	Noise Figure
					K	Measure			
(MHz)	(dB)	(dB)	(dB)	(dB)	K	Measure	(dBm)	(dBm)	(dB)
10	9.52	27.80	2.58	1.24	1.16	0.21	26.97	17.70	4.91
20	14.71	21.80	9.41	7.93	1.19	0.63	45.51	22.07	2.91
30	15.38	20.99	14.81	15.25	1.18	0.70	46.58	23.17	2.66
40	15.52	20.84	17.82	20.86	1.18	0.71	46.32	23.62	2.52
50	15.48	20.73	20.94	25.05	1.18	0.70	47.79	23.73	2.43
60	15.57	20.77	19.86	29.26	1.18	0.70	45.77	23.98	2.42
70	15.59	20.73	19.79	30.39	1.17	0.70	48.21	24.06	2.39
80	15.60	20.71	20.09	29.80	1.17	0.70	47.37	24.16	2.33
90	15.60	20.71	20.08	28.64	1.17	0.70	45.76	24.22	2.31
100	15.60	20.68	20.04	27.60	1.17	0.69	44.88	24.26	2.29
150	15.62	20.64	19.42	24.92	1.17	0.69	45.95	24.36	2.29
200	15.62	20.62	20.13	24.44	1.16	0.68	44.94	24.43	2.28
250	15.64	20.63	20.94	25.07	1.16	0.68	47.23	24.58	2.29
300	15.65	20.63	21.23	25.93	1.16	0.68	44.90	24.66	2.30
350	15.66	20.62	21.43	26.59	1.16	0.68	46.49	24.78	2.36
400	15.67	20.64	21.81	26.87	1.16	0.68	48.49	24.78	2.33
450	15.67	20.66	21.77	26.40	1.17	0.68	48.32	24.85	2.29
500	15.68	20.67	21.64	25.86	1.17	0.68	48.90	24.91	2.33
550	15.66	20.69	21.22	25.01	1.17	0.69	49.42	24.90	2.39
600	15.68	20.72	20.99	24.13	1.17	0.69	52.27	24.92	2.44
650	15.68	20.74	20.61	23.21	1.17	0.69	51.19	24.96	2.41
700	15.68	20.77	20.33	22.33	1.17	0.69	48.97	24.92	2.45
750	15.68	20.80	19.96	21.54	1.17	0.69	48.77	24.97	2.44
800	15.66	20.85	19.48	20.80	1.17	0.69	49.68	24.98	2.41
850	15.66	20.89	19.01	20.05	1.18	0.69	46.18	24.89	2.44
900	15.67	20.92	18.76	19.13	1.18	0.69	44.38	24.90	2.39
950	15.67	20.95	18.52	18.22	1.18	0.69	45.01	24.83	2.47
1000	15.67	20.98	18.13	17.29	1.18	0.69	49.41	24.75	2.41
1050	15.65	21.03	17.79	16.49	1.18	0.69	47.06	24.55	2.51
1100	15.63	21.07	17.39	15.65	1.18	0.68	45.09	24.47	2.47
1150	15.62	21.14	17.11	14.94	1.18	0.68	42.65	24.29	2.50
1200	15.59	21.19	16.60	14.27	1.18	0.68	42.73	24.19	2.44
1250	15.57	21.25	16.25	13.65	1.19	0.68	41.83	23.99	2.33
1300	15.53	21.32	15.84	12.96	1.19	0.68	41.89	23.92	2.45
1350	15.49	21.39	15.42	12.29	1.19	0.68	41.64	23.83	2.38
1400	15.44	21.47	14.97	11.61	1.19	0.67	42.69	23.68	2.51
1450	15.39	21.55	14.56	10.99	1.19	0.67	42.37	23.53	2.51
1500	15.33	21.65	14.23	10.39	1.20	0.66	42.51	23.36	2.50
1550	15.28	21.73	13.85	9.84	1.20	0.66	41.05	22.34	2.51
1600	15.20	21.82	13.48	9.26	1.20	0.65	41.69	23.07	2.47
1700	15.04	22.04	12.80	8.22	1.20	0.63	40.90	23.14	2.46
1800	14.85	22.29	12.02	7.23	1.19	0.61	40.50	22.86	2.63
1900	14.60	22.60	11.27	6.29	1.19	0.58	38.59	22.38	2.53
2000	14.31	22.94	10.31	5.46	1.19	0.55	37.90	21.84	2.60

Typical Performance Data

Definitions:

Input Return Loss = -S11 (dB)

Gain(Power Gain) = S21 (dB)

Reverse Isolation = -S12 (dB)

Output Return Loss = -S22 (dB)

TEST CONDITIONS: Vd = 8.00V, Id = 97.86mA @ Temperature = -45°C

FREQ	Gain	Isolation	Input Return Loss	Output Return Loss	Stability		IP-3 Output	1dB Comp. Output	Noise Figure
					K	Measure			
(MHz)	(dB)	(dB)	(dB)	(dB)	K	Measure	(dBm)	(dBm)	(dB)
10	9.45	27.45	2.77	1.25	1.16	0.21	26.19	16.28	4.55
20	14.63	21.77	9.29	7.95	1.19	0.63	45.94	20.63	2.66
30	15.29	20.97	14.61	15.36	1.18	0.71	46.61	21.73	2.47
40	15.43	20.78	17.48	21.02	1.18	0.71	46.14	22.18	2.42
50	15.38	20.66	19.01	25.32	1.18	0.71	46.60	22.29	2.37
60	15.48	20.70	19.27	28.99	1.18	0.71	46.80	22.54	2.35
70	15.50	20.68	19.34	29.69	1.17	0.70	45.79	22.62	2.33
80	15.51	20.65	19.71	28.88	1.17	0.70	43.61	22.72	2.27
90	15.52	20.65	19.62	27.75	1.17	0.70	43.58	22.78	2.24
100	15.51	20.64	19.74	26.77	1.17	0.70	43.24	22.82	2.26
150	15.53	20.59	18.99	24.27	1.17	0.69	42.52	22.90	2.18
200	15.53	20.58	19.66	23.82	1.17	0.69	41.96	22.96	2.24
250	15.54	20.58	20.27	24.40	1.17	0.69	42.63	23.09	2.29
300	15.55	20.57	20.72	25.18	1.17	0.68	43.07	23.15	2.25
350	15.57	20.58	20.85	25.76	1.17	0.68	43.30	23.27	2.29
400	15.58	20.59	21.31	25.99	1.17	0.68	45.73	23.26	2.33
450	15.58	20.60	21.23	25.54	1.17	0.69	45.84	23.32	2.24
500	15.59	20.62	21.10	25.05	1.17	0.69	43.53	23.37	2.32
550	15.57	20.64	20.71	24.27	1.17	0.69	44.46	23.39	2.34
600	15.58	20.67	20.52	23.45	1.17	0.69	48.49	23.38	2.38
650	15.59	20.69	20.10	22.59	1.17	0.69	48.47	23.44	2.42
700	15.59	20.73	19.89	21.76	1.17	0.69	47.34	23.38	2.38
750	15.59	20.76	19.50	21.00	1.17	0.69	46.35	23.43	2.37
800	15.57	20.81	19.09	20.29	1.18	0.69	52.02	23.44	2.37
850	15.57	20.85	18.67	19.57	1.18	0.69	46.69	23.34	2.38
900	15.58	20.88	18.35	18.69	1.18	0.69	50.01	23.35	2.36
950	15.58	20.91	18.10	17.81	1.18	0.69	43.26	23.27	2.40
1000	15.57	20.95	17.82	16.92	1.18	0.69	43.79	23.18	2.37
1050	15.55	20.99	17.51	16.14	1.18	0.69	45.99	22.98	2.48
1100	15.53	21.04	17.12	15.32	1.18	0.69	45.08	22.90	2.38
1150	15.51	21.11	16.83	14.63	1.18	0.69	42.08	22.69	2.41
1200	15.48	21.15	16.41	13.97	1.19	0.68	41.23	22.58	2.44
1250	15.45	21.21	15.95	13.35	1.19	0.68	40.68	22.36	2.33
1300	15.42	21.29	15.58	12.68	1.19	0.68	40.25	22.28	2.35
1350	15.36	21.36	15.16	12.03	1.19	0.68	39.81	22.18	2.32
1400	15.31	21.45	14.75	11.37	1.20	0.67	40.07	22.04	2.48
1450	15.26	21.53	14.31	10.77	1.20	0.67	40.07	21.89	2.48
1500	15.20	21.63	13.94	10.18	1.20	0.66	39.82	21.73	2.42
1550	15.14	21.71	13.69	9.64	1.20	0.66	38.95	21.57	2.49
1600	15.06	21.81	13.23	9.07	1.20	0.65	39.29	21.47	2.43
1700	14.89	22.03	12.56	8.05	1.20	0.63	38.43	21.51	2.48
1800	14.69	22.28	11.83	7.08	1.20	0.61	38.70	21.20	2.52
1900	14.44	22.59	11.01	6.15	1.19	0.58	37.27	20.71	2.46
2000	14.13	22.94	10.07	5.34	1.19	0.55	36.10	20.16	2.59

Typical Performance Data

Definitions:

Input Return Loss = -S11 (dB)

Gain(Power Gain) = S21 (dB)

Reverse Isolation = -S12 (dB)

Output Return Loss = -S22 (dB)

TEST CONDITIONS: Vd = 7.00V, Id = 83.09mA @ Temperature = -45°C

FREQ	Gain	Isolation	Input Return Loss	Output Return Loss	Stability		IP-3 Output	1dB Comp. Output	Noise Figure
					K	Measure			
(MHz)	(dB)	(dB)	(dB)	(dB)	K	Measure	(dBm)	(dBm)	(dB)
10	9.31	27.44	3.33	1.22	1.18	0.20	27.16	15.21	4.19
20	14.55	21.68	9.45	7.96	1.19	0.63	38.76	19.53	2.54
30	15.20	20.86	14.65	15.46	1.18	0.71	44.44	20.62	2.41
40	15.35	20.74	17.26	21.23	1.18	0.72	44.30	21.08	2.34
50	15.30	20.76	19.26	25.46	1.19	0.72	43.58	21.18	2.29
60	15.40	20.61	19.08	28.72	1.18	0.71	44.01	21.43	2.30
70	15.42	20.62	19.08	28.94	1.18	0.70	41.86	21.51	2.26
80	15.43	20.60	19.41	28.07	1.18	0.70	42.07	21.60	2.28
90	15.43	20.61	19.21	26.93	1.18	0.70	40.82	21.66	2.23
100	15.43	20.58	19.20	26.03	1.17	0.70	40.19	21.70	2.23
150	15.44	20.54	18.91	23.71	1.17	0.69	40.47	21.76	2.20
200	15.44	20.52	19.41	23.28	1.17	0.69	40.31	21.81	2.24
250	15.46	20.53	19.91	23.81	1.17	0.69	40.12	21.92	2.20
300	15.47	20.53	20.30	24.53	1.17	0.69	42.38	21.95	2.24
350	15.49	20.53	20.64	25.05	1.17	0.69	42.07	22.07	2.26
400	15.49	20.54	20.81	25.21	1.17	0.69	44.35	22.03	2.25
450	15.50	20.56	20.68	24.79	1.17	0.69	46.16	22.11	2.23
500	15.51	20.58	20.61	24.31	1.17	0.69	42.49	22.15	2.26
550	15.49	20.60	20.18	23.56	1.17	0.69	44.05	22.17	2.28
600	15.50	20.63	20.04	22.79	1.17	0.69	44.90	22.14	2.30
650	15.51	20.65	19.70	21.97	1.17	0.69	42.64	22.21	2.32
700	15.51	20.69	19.43	21.18	1.17	0.69	44.32	22.13	2.32
750	15.50	20.72	19.09	20.45	1.18	0.69	41.87	22.18	2.35
800	15.49	20.78	18.67	19.77	1.18	0.70	43.22	22.18	2.31
850	15.48	20.81	18.26	19.07	1.18	0.70	41.13	22.06	2.32
900	15.49	20.85	17.97	18.22	1.18	0.70	41.44	22.07	2.32
950	15.49	20.88	17.79	17.38	1.18	0.69	39.50	21.96	2.33
1000	15.48	20.92	17.50	16.51	1.18	0.69	40.82	21.86	2.33
1050	15.46	20.96	17.19	15.75	1.18	0.69	40.29	21.66	2.45
1100	15.43	21.02	16.76	14.96	1.19	0.69	39.67	21.57	2.35
1150	15.41	21.08	16.53	14.28	1.19	0.69	38.17	21.34	2.38
1200	15.38	21.13	16.08	13.64	1.19	0.69	37.92	21.24	2.39
1250	15.34	21.20	15.68	13.04	1.19	0.69	37.01	21.01	2.34
1300	15.31	21.27	15.29	12.38	1.19	0.68	36.92	20.92	2.39
1350	15.25	21.35	14.81	11.75	1.20	0.68	36.30	20.80	2.28
1400	15.20	21.43	14.48	11.10	1.20	0.68	36.66	20.69	2.34
1450	15.14	21.52	14.10	10.51	1.20	0.67	36.69	20.55	2.42
1500	15.08	21.62	13.68	9.94	1.20	0.67	36.34	20.39	2.42
1550	15.02	21.70	13.39	9.41	1.20	0.66	35.44	20.25	2.51
1600	14.93	21.81	13.02	8.86	1.20	0.65	35.65	20.14	2.38
1700	14.75	22.03	12.33	7.86	1.20	0.63	34.89	20.15	2.44
1800	14.55	22.29	11.58	6.91	1.20	0.61	34.43	19.80	2.50
1900	14.28	22.60	10.87	6.01	1.20	0.58	33.54	19.28	2.46
2000	13.96	22.96	9.86	5.22	1.19	0.55	32.58	18.71	2.54

Typical Performance Data

Definitions:

Input Return Loss = -S11 (dB)

Gain(Power Gain) = S21 (dB)

Reverse Isolation = -S12 (dB)

Output Return Loss = -S22 (dB)

TEST CONDITIONS: Vd = 9.00V, Id = 115.65mA @ Temperature = +85°C

FREQ	Gain	Isolation	Input Return Loss	Output Return Loss	Stability		IP-3 Output	1dB Comp. Output	Noise Figure
					K	Measure			
(MHz)	(dB)	(dB)	(dB)	(dB)	K	Measure	(dBm)	(dBm)	(dB)
10	9.50	27.15	3.55	1.32	1.20	0.21	26.83	17.05	5.07
20	14.63	21.61	9.64	8.27	1.19	0.64	41.78	21.49	3.55
30	15.24	20.90	15.33	15.83	1.18	0.71	48.58	22.57	3.40
40	15.38	20.75	18.29	21.69	1.18	0.71	43.84	23.00	3.35
50	15.32	20.77	21.71	25.79	1.20	0.72	46.88	23.09	3.30
60	15.41	20.64	21.04	30.31	1.18	0.71	43.84	23.34	3.30
70	15.43	20.66	20.88	31.82	1.18	0.70	43.80	23.41	3.29
80	15.43	20.64	21.18	31.78	1.18	0.70	42.84	23.50	3.23
90	15.44	20.63	21.23	31.25	1.18	0.70	42.51	23.55	3.15
100	15.43	20.62	21.36	30.62	1.18	0.70	42.92	23.58	3.21
150	15.45	20.59	21.27	29.35	1.18	0.70	42.45	23.64	3.19
200	15.44	20.56	22.19	28.86	1.18	0.69	42.26	23.68	3.18
250	15.44	20.58	21.87	28.06	1.18	0.70	43.79	23.82	3.24
300	15.44	20.59	21.60	26.89	1.18	0.69	43.98	23.89	3.21
350	15.45	20.60	20.94	25.66	1.18	0.70	44.18	23.99	3.27
400	15.45	20.62	20.76	24.90	1.18	0.70	46.46	23.99	3.26
450	15.45	20.64	20.35	24.10	1.18	0.70	44.17	24.04	3.21
500	15.46	20.66	20.38	23.72	1.18	0.70	44.59	24.09	3.30
550	15.44	20.69	19.96	23.20	1.18	0.70	45.77	24.06	3.31
600	15.45	20.71	20.00	22.80	1.18	0.70	46.62	24.08	3.38
650	15.45	20.74	19.66	22.37	1.18	0.70	45.86	24.09	3.40
700	15.45	20.78	19.53	21.92	1.19	0.70	46.98	24.06	3.43
750	15.45	20.82	19.19	21.42	1.19	0.71	43.12	24.09	3.37
800	15.44	20.86	18.87	20.76	1.19	0.71	45.42	24.09	3.34
850	15.45	20.89	18.56	20.05	1.19	0.71	43.93	23.97	3.35
900	15.45	20.93	18.24	19.25	1.19	0.71	43.84	23.97	3.38
950	15.44	20.97	18.04	18.48	1.19	0.71	41.10	23.89	3.39
1000	15.44	21.01	17.69	17.65	1.19	0.71	42.51	23.80	3.37
1050	15.42	21.05	17.43	16.90	1.20	0.71	41.86	23.63	3.52
1100	15.40	21.11	17.06	16.02	1.20	0.71	41.26	23.53	3.38
1150	15.37	21.17	16.77	15.21	1.20	0.71	39.98	23.36	3.48
1200	15.34	21.23	16.37	14.42	1.21	0.70	39.38	23.24	3.44
1250	15.31	21.30	15.88	13.68	1.21	0.70	38.66	23.08	3.38
1300	15.27	21.37	15.54	12.93	1.21	0.70	38.27	23.01	3.44
1350	15.21	21.46	15.17	12.21	1.21	0.70	37.95	22.85	3.39
1400	15.15	21.55	14.76	11.50	1.22	0.69	38.00	22.70	3.54
1450	15.09	21.64	14.32	10.83	1.22	0.69	37.81	22.54	3.55
1500	15.02	21.76	13.76	10.19	1.22	0.68	37.46	22.38	3.50
1550	14.94	21.87	13.44	9.57	1.23	0.68	36.57	21.66	3.59
1600	14.84	21.99	12.90	8.98	1.23	0.67	36.88	22.14	3.47
1700	14.62	22.24	11.97	7.91	1.23	0.65	36.19	21.92	3.55
1800	14.37	22.56	10.96	6.93	1.24	0.63	35.63	21.39	3.66
1900	14.06	22.91	10.02	6.03	1.24	0.61	34.75	20.77	3.73
2000	13.71	23.31	8.96	5.23	1.24	0.58	33.85	20.15	3.78

Typical Performance Data

Definitions:

Input Return Loss = -S11 (dB)

Gain(Power Gain) = S21 (dB)

Reverse Isolation = -S12 (dB)

Output Return Loss = -S22 (dB)

TEST CONDITIONS: Vd = 8.50V, Id = 108.26mA @ Temperature = +85°C

FREQ	Gain	Isolation	Input Return Loss	Output Return Loss	Stability		IP-3 Output	1dB Comp. Output	Noise Figure
					K	Measure			
(MHz)	(dB)	(dB)	(dB)	(dB)	K	Measure	(dBm)	(dBm)	(dB)
10	9.51	27.70	2.88	1.31	1.19	0.23	26.79	16.57	4.98
20	14.60	21.64	9.94	8.27	1.19	0.64	41.98	20.99	3.45
30	15.22	20.88	15.30	15.88	1.19	0.71	49.89	22.07	3.32
40	15.35	20.74	18.49	21.74	1.18	0.71	57.39	22.50	3.30
50	15.30	20.73	19.10	25.96	1.19	0.72	43.41	22.58	3.30
60	15.38	20.64	20.54	30.39	1.18	0.71	44.70	22.84	3.28
70	15.40	20.64	20.78	31.73	1.18	0.71	43.65	22.91	3.25
80	15.41	20.62	21.13	31.63	1.18	0.70	42.05	23.01	3.19
90	15.41	20.62	21.18	31.07	1.18	0.70	41.46	23.06	3.18
100	15.40	20.60	21.07	30.43	1.18	0.70	41.88	23.09	3.18
150	15.42	20.56	21.36	29.13	1.18	0.70	42.55	23.14	3.09
200	15.41	20.55	22.05	28.67	1.18	0.70	41.90	23.18	3.20
250	15.42	20.56	22.01	27.88	1.18	0.70	42.12	23.31	3.22
300	15.42	20.57	21.43	26.72	1.18	0.70	43.56	23.37	3.20
350	15.43	20.59	20.76	25.47	1.18	0.70	44.09	23.48	3.26
400	15.43	20.61	20.67	24.73	1.18	0.70	46.99	23.47	3.25
450	15.43	20.63	20.17	23.94	1.18	0.70	49.17	23.52	3.18
500	15.43	20.65	20.13	23.57	1.18	0.70	44.28	23.58	3.26
550	15.42	20.68	19.87	23.04	1.18	0.70	43.54	23.56	3.29
600	15.43	20.70	19.83	22.65	1.18	0.70	47.42	23.56	3.31
650	15.43	20.73	19.54	22.21	1.18	0.70	44.16	23.58	3.35
700	15.43	20.77	19.41	21.76	1.19	0.70	45.33	23.55	3.35
750	15.42	20.81	19.02	21.26	1.19	0.71	43.36	23.58	3.34
800	15.42	20.85	18.78	20.60	1.19	0.71	44.54	23.58	3.33
850	15.42	20.89	18.44	19.89	1.19	0.71	41.96	23.46	3.37
900	15.42	20.92	18.18	19.10	1.19	0.71	42.19	23.46	3.32
950	15.41	20.96	17.91	18.34	1.19	0.71	40.40	23.38	3.37
1000	15.40	21.00	17.64	17.52	1.20	0.71	41.36	23.29	3.36
1050	15.39	21.05	17.27	16.77	1.20	0.71	41.03	23.12	3.48
1100	15.36	21.10	16.98	15.90	1.20	0.71	40.07	23.02	3.37
1150	15.34	21.17	16.69	15.09	1.20	0.71	38.66	22.85	3.44
1200	15.31	21.23	16.25	14.32	1.21	0.71	38.52	22.73	3.37
1250	15.27	21.30	15.85	13.58	1.21	0.70	37.66	22.57	3.38
1300	15.23	21.37	15.51	12.83	1.21	0.70	37.60	22.50	3.42
1350	15.17	21.45	15.13	12.13	1.22	0.70	36.81	22.33	3.35
1400	15.11	21.55	14.66	11.42	1.22	0.69	37.19	22.18	3.46
1450	15.05	21.65	14.24	10.75	1.22	0.69	36.77	22.02	3.50
1500	14.97	21.76	13.74	10.11	1.22	0.68	36.57	21.86	3.49
1550	14.89	21.86	13.37	9.50	1.23	0.68	35.84	21.39	3.54
1600	14.79	21.99	12.88	8.92	1.23	0.67	35.90	21.63	3.46
1700	14.57	22.26	11.98	7.86	1.23	0.65	35.22	21.43	3.51
1800	14.31	22.56	10.94	6.89	1.24	0.63	34.83	20.93	3.66
1900	14.00	22.92	9.97	5.99	1.24	0.61	33.75	20.31	3.68
2000	13.64	23.32	8.94	5.20	1.24	0.58	32.99	19.70	3.74

Typical Performance Data

Definitions:

Input Return Loss = -S11 (dB)

Gain(Power Gain) = S21 (dB)

Reverse Isolation = -S12 (dB)

Output Return Loss = -S22 (dB)

TEST CONDITIONS: Vd = 9.50V, Id = 122.78mA @ Temperature = +85°C

FREQ	Gain	Isolation	Input Return Loss	Output Return Loss	Stability		IP-3 Output	1dB Comp. Output	Noise Figure
					K	Measure			
(MHz)	(dB)	(dB)	(dB)	(dB)	K	Measure	(dBm)	(dBm)	(dB)
10	9.58	27.07	3.39	1.33	1.18	0.21	27.29	17.52	5.12
20	14.66	21.65	9.54	8.28	1.19	0.64	45.45	21.95	3.60
30	15.25	20.89	15.15	15.84	1.18	0.71	42.52	23.03	3.43
40	15.39	20.77	18.56	21.67	1.18	0.71	44.67	23.46	3.38
50	15.34	20.78	22.13	25.79	1.20	0.71	43.82	23.54	3.34
60	15.43	20.70	21.41	30.39	1.18	0.71	42.21	23.79	3.35
70	15.45	20.68	21.05	31.91	1.18	0.71	43.47	23.86	3.31
80	15.45	20.64	21.47	31.84	1.18	0.70	43.37	23.96	3.26
90	15.46	20.64	21.34	31.31	1.18	0.70	42.35	24.00	3.19
100	15.45	20.63	21.51	30.73	1.18	0.70	42.31	24.04	3.24
150	15.46	20.59	21.74	29.43	1.18	0.70	42.67	24.10	3.23
200	15.46	20.58	22.38	28.97	1.18	0.69	42.59	24.14	3.24
250	15.46	20.59	22.30	28.17	1.18	0.69	42.52	24.28	3.25
300	15.46	20.59	21.76	27.00	1.17	0.69	44.38	24.37	3.25
350	15.47	20.61	21.10	25.76	1.18	0.69	43.93	24.47	3.36
400	15.47	20.63	20.84	25.02	1.18	0.70	46.99	24.46	3.30
450	15.47	20.65	20.54	24.24	1.18	0.70	45.41	24.51	3.25
500	15.47	20.67	20.44	23.89	1.18	0.70	45.13	24.57	3.32
550	15.46	20.70	20.11	23.36	1.18	0.70	46.77	24.54	3.31
600	15.47	20.72	20.08	22.99	1.18	0.70	48.00	24.55	3.40
650	15.47	20.75	19.74	22.56	1.18	0.70	46.44	24.56	3.42
700	15.47	20.78	19.58	22.12	1.18	0.70	48.68	24.54	3.42
750	15.47	20.82	19.27	21.63	1.19	0.70	44.59	24.56	3.35
800	15.46	20.86	18.94	20.98	1.19	0.71	45.41	24.56	3.37
850	15.47	20.89	18.65	20.26	1.19	0.71	45.20	24.44	3.36
900	15.47	20.92	18.33	19.47	1.19	0.71	45.76	24.44	3.32
950	15.47	20.97	18.08	18.69	1.19	0.71	42.11	24.36	3.44
1000	15.46	21.01	17.76	17.86	1.19	0.71	42.84	24.26	3.40
1050	15.44	21.05	17.47	17.10	1.20	0.71	42.97	24.09	3.50
1100	15.42	21.11	17.14	16.21	1.20	0.71	42.56	23.99	3.44
1150	15.41	21.17	16.76	15.38	1.20	0.71	40.70	23.82	3.51
1200	15.38	21.22	16.30	14.59	1.20	0.70	40.36	23.70	3.40
1250	15.34	21.29	15.95	13.84	1.21	0.70	39.75	23.54	3.39
1300	15.30	21.37	15.56	13.08	1.21	0.70	39.12	23.47	3.42
1350	15.25	21.44	15.14	12.36	1.21	0.70	38.51	23.31	3.42
1400	15.19	21.55	14.77	11.64	1.22	0.69	38.55	23.17	3.50
1450	15.13	21.63	14.34	10.95	1.22	0.69	38.30	23.01	3.61
1500	15.06	21.74	13.81	10.30	1.22	0.68	38.10	22.85	3.53
1550	14.99	21.85	13.39	9.68	1.22	0.67	37.42	21.91	3.63
1600	14.89	21.96	12.88	9.07	1.23	0.67	37.51	22.60	3.53
1700	14.68	22.23	11.96	7.99	1.23	0.65	36.85	22.33	3.58
1800	14.43	22.54	10.97	7.00	1.23	0.63	36.23	21.79	3.70
1900	14.13	22.90	9.99	6.08	1.24	0.61	35.30	21.15	3.78
2000	13.78	23.28	8.92	5.27	1.23	0.58	34.43	20.52	3.84

Typical Performance Data

Definitions:

Input Return Loss = -S11 (dB)

Gain(Power Gain) = S21 (dB)

Reverse Isolation = -S12 (dB)

Output Return Loss = -S22 (dB)

TEST CONDITIONS: Vd = 8.00V, Id = 100.85mA @ Temperature = +85°C

FREQ	Gain	Isolation	Input Return Loss	Output Return Loss	Stability		IP-3 Output	1dB Comp. Output	Noise Figure
					K	Measure			
(MHz)	(dB)	(dB)	(dB)	(dB)	K	Measure	(dBm)	(dBm)	(dB)
10	9.48	27.29	3.18	1.31	1.19	0.22	26.74	16.07	4.82
20	14.58	21.66	9.65	8.28	1.19	0.65	43.43	20.48	3.43
30	15.19	20.85	15.60	15.89	1.19	0.71	42.25	21.55	3.29
40	15.32	20.72	18.41	21.79	1.18	0.71	45.25	21.98	3.25
50	15.25	20.77	19.82	25.96	1.20	0.73	42.24	22.07	3.26
60	15.35	20.65	20.11	30.36	1.18	0.71	44.13	22.33	3.28
70	15.37	20.63	20.41	31.62	1.18	0.71	42.55	22.39	3.22
80	15.37	20.60	21.07	31.47	1.18	0.70	41.99	22.49	3.17
90	15.38	20.61	20.76	30.91	1.18	0.70	41.29	22.54	3.14
100	15.38	20.59	21.21	30.27	1.18	0.70	41.28	22.57	3.16
150	15.39	20.55	21.00	28.95	1.18	0.70	41.00	22.61	3.11
200	15.38	20.54	21.85	28.51	1.18	0.70	41.00	22.65	3.19
250	15.39	20.56	21.57	27.69	1.18	0.70	41.53	22.77	3.21
300	15.39	20.56	21.32	26.53	1.18	0.70	43.98	22.83	3.20
350	15.39	20.57	20.48	25.28	1.18	0.70	44.20	22.93	3.26
400	15.39	20.60	20.46	24.54	1.18	0.70	46.66	22.92	3.23
450	15.39	20.62	20.09	23.75	1.18	0.70	48.45	22.98	3.16
500	15.40	20.64	19.95	23.37	1.18	0.70	46.30	23.03	3.24
550	15.38	20.67	19.69	22.84	1.18	0.70	44.65	23.01	3.28
600	15.39	20.70	19.74	22.44	1.18	0.70	44.45	23.01	3.29
650	15.39	20.72	19.38	21.98	1.19	0.70	43.16	23.04	3.31
700	15.39	20.77	19.22	21.53	1.19	0.71	44.01	23.00	3.37
750	15.39	20.81	18.92	21.01	1.19	0.71	41.75	23.04	3.32
800	15.38	20.84	18.62	20.36	1.19	0.71	42.57	23.03	3.35
850	15.38	20.88	18.30	19.66	1.19	0.71	40.84	22.91	3.28
900	15.38	20.92	18.04	18.87	1.20	0.71	40.75	22.91	3.27
950	15.37	20.96	17.83	18.11	1.20	0.71	38.92	22.83	3.33
1000	15.36	21.00	17.49	17.30	1.20	0.71	40.83	22.75	3.31
1050	15.34	21.04	17.22	16.56	1.20	0.71	39.49	22.58	3.47
1100	15.32	21.11	16.92	15.70	1.20	0.71	38.84	22.47	3.39
1150	15.30	21.17	16.60	14.90	1.21	0.71	37.30	22.30	3.40
1200	15.26	21.23	16.23	14.14	1.21	0.71	37.48	22.18	3.35
1250	15.22	21.30	15.79	13.41	1.21	0.71	36.55	22.02	3.31
1300	15.17	21.39	15.46	12.67	1.22	0.70	36.48	21.95	3.37
1350	15.11	21.47	15.05	11.97	1.22	0.70	36.02	21.77	3.33
1400	15.05	21.56	14.64	11.28	1.22	0.70	36.18	21.62	3.41
1450	14.98	21.65	14.24	10.62	1.22	0.69	35.65	21.46	3.52
1500	14.91	21.77	13.74	9.99	1.23	0.69	35.56	21.30	3.47
1550	14.82	21.88	13.34	9.39	1.23	0.68	34.84	21.13	3.50
1600	14.72	22.01	12.84	8.81	1.23	0.67	34.89	21.08	3.42
1700	14.49	22.27	11.92	7.77	1.24	0.66	34.29	20.90	3.50
1800	14.23	22.58	10.98	6.82	1.24	0.64	33.61	20.39	3.61
1900	13.91	22.94	9.99	5.93	1.24	0.61	32.76	19.78	3.65
2000	13.55	23.34	8.91	5.15	1.24	0.58	31.95	19.18	3.67

Typical Performance Data

Definitions:

Input Return Loss = -S11 (dB)

Gain(Power Gain) = S21 (dB)

Reverse Isolation = -S12 (dB)

Output Return Loss = -S22 (dB)

TEST CONDITIONS: Vd = 7.00V, Id = 86.18mA @ Temperature = +85°C

FREQ	Gain	Isolation	Input Return Loss	Output Return Loss	Stability		IP-3 Output	1dB Comp. Output	Noise Figure
					K	Measure			
(MHz)	(dB)	(dB)	(dB)	(dB)	K	Measure	(dBm)	(dBm)	(dB)
10	9.41	27.26	2.98	1.31	1.18	0.22	27.68	15.07	4.66
20	14.50	21.55	9.99	8.29	1.19	0.64	34.32	19.37	3.37
30	15.10	20.82	15.14	15.94	1.19	0.72	42.82	20.42	3.25
40	15.24	20.68	18.10	21.93	1.19	0.72	43.09	20.86	3.24
50	15.17	20.60	20.97	26.19	1.19	0.72	43.47	20.96	3.21
60	15.27	20.58	20.85	30.43	1.19	0.71	42.59	21.20	3.18
70	15.28	20.58	20.28	31.45	1.18	0.71	40.30	21.27	3.21
80	15.29	20.56	20.40	31.08	1.18	0.71	40.48	21.36	3.12
90	15.29	20.56	20.57	30.41	1.18	0.71	39.88	21.41	3.08
100	15.29	20.54	20.61	29.78	1.18	0.71	39.70	21.44	3.11
150	15.30	20.52	20.65	28.46	1.18	0.70	39.80	21.45	3.06
200	15.29	20.50	21.21	27.95	1.18	0.70	40.08	21.48	3.14
250	15.30	20.53	21.15	27.12	1.18	0.70	40.55	21.58	3.15
300	15.30	20.53	20.78	25.97	1.18	0.70	43.14	21.61	3.14
350	15.30	20.54	20.16	24.72	1.18	0.70	43.04	21.73	3.19
400	15.31	20.58	19.94	23.97	1.18	0.70	45.25	21.70	3.21
450	15.30	20.60	19.54	23.16	1.18	0.70	47.09	21.76	3.15
500	15.31	20.61	19.57	22.75	1.18	0.70	44.34	21.80	3.18
550	15.29	20.65	19.19	22.19	1.19	0.71	41.52	21.80	3.25
600	15.30	20.68	19.23	21.76	1.19	0.71	41.63	21.79	3.23
650	15.30	20.71	18.92	21.27	1.19	0.71	40.59	21.83	3.32
700	15.30	20.75	18.77	20.79	1.19	0.71	40.21	21.77	3.30
750	15.29	20.79	18.49	20.26	1.20	0.71	38.74	21.81	3.28
800	15.28	20.84	18.24	19.60	1.20	0.71	39.36	21.80	3.27
850	15.28	20.87	17.94	18.90	1.20	0.72	38.21	21.68	3.26
900	15.27	20.92	17.71	18.13	1.20	0.72	37.96	21.68	3.25
950	15.26	20.96	17.57	17.39	1.20	0.72	36.74	21.59	3.32
1000	15.24	21.01	17.27	16.60	1.20	0.72	38.20	21.51	3.26
1050	15.22	21.05	16.96	15.88	1.21	0.72	36.75	21.34	3.37
1100	15.19	21.11	16.70	15.06	1.21	0.71	36.16	21.23	3.30
1150	15.16	21.19	16.42	14.29	1.21	0.71	35.22	21.05	3.36
1200	15.11	21.25	16.03	13.56	1.22	0.71	35.08	20.93	3.37
1250	15.06	21.33	15.65	12.86	1.22	0.71	34.46	20.76	3.31
1300	15.01	21.42	15.28	12.16	1.22	0.71	34.49	20.69	3.36
1350	14.95	21.51	14.95	11.49	1.23	0.70	33.80	20.50	3.30
1400	14.88	21.60	14.57	10.83	1.23	0.70	33.89	20.35	3.39
1450	14.80	21.70	14.07	10.19	1.23	0.69	33.56	20.19	3.41
1500	14.71	21.83	13.68	9.60	1.24	0.69	33.46	20.03	3.39
1550	14.62	21.93	13.30	9.02	1.24	0.68	32.66	19.87	3.43
1600	14.51	22.06	12.78	8.47	1.24	0.67	32.81	19.81	3.35
1700	14.26	22.34	11.88	7.48	1.25	0.66	32.22	19.64	3.47
1800	13.98	22.66	10.89	6.57	1.25	0.64	31.49	19.14	3.61
1900	13.65	23.03	9.98	5.73	1.25	0.61	30.68	18.54	3.58
2000	13.28	23.42	8.91	4.99	1.25	0.59	29.96	17.93	3.63

Typical Performance Curves

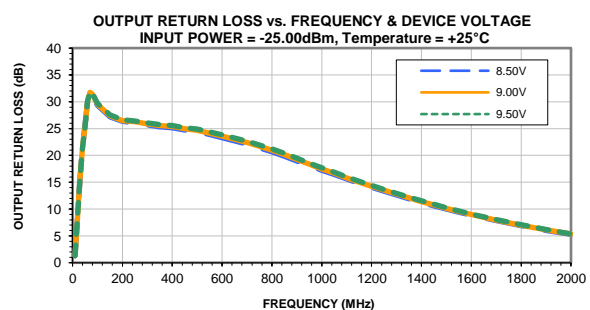
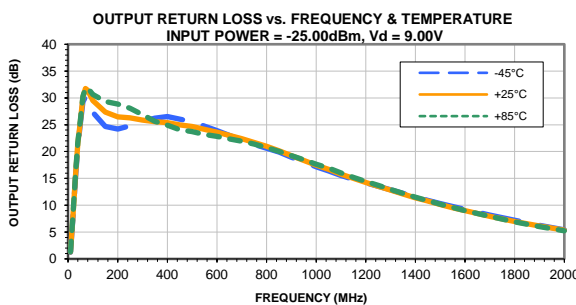
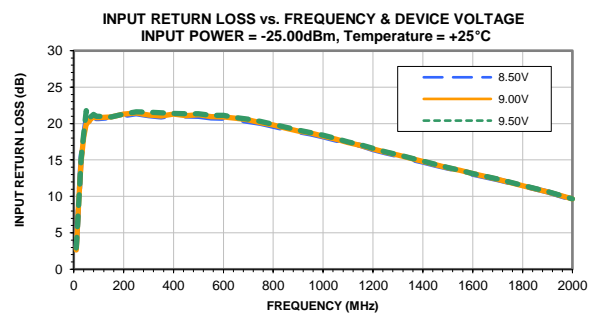
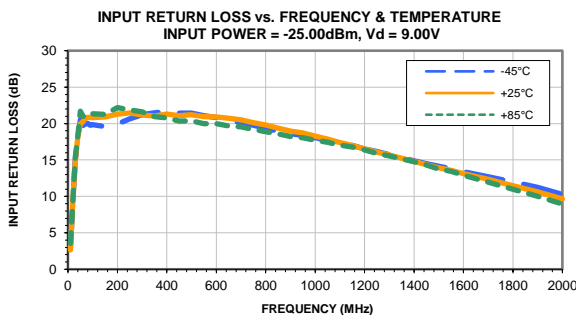
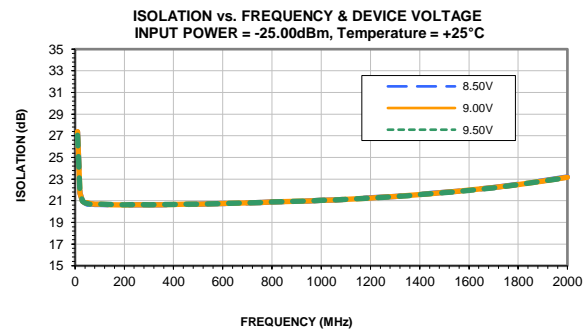
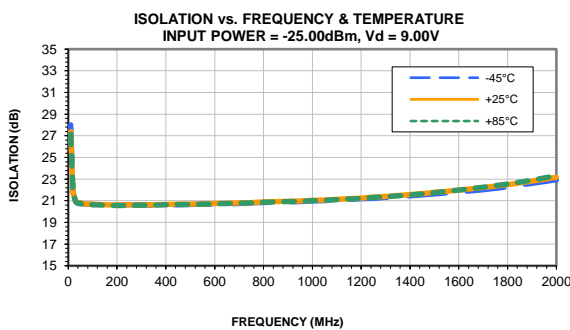
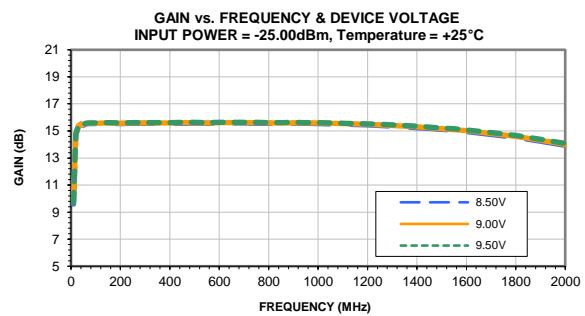
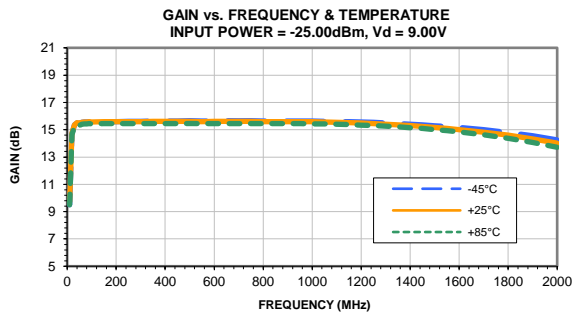

Typical Performance Curves

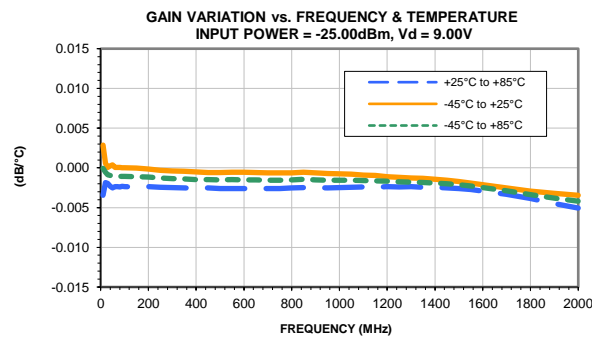
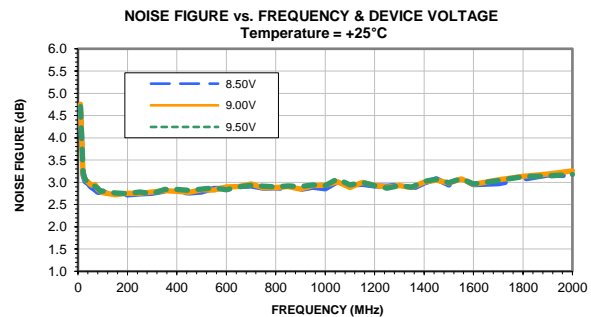
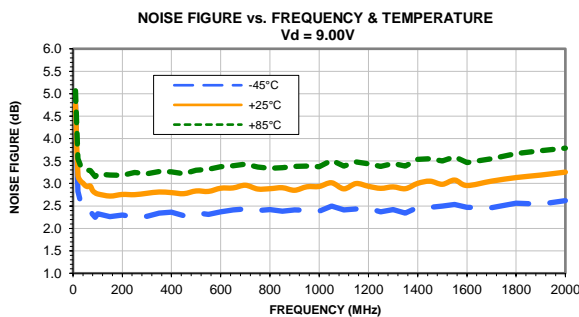
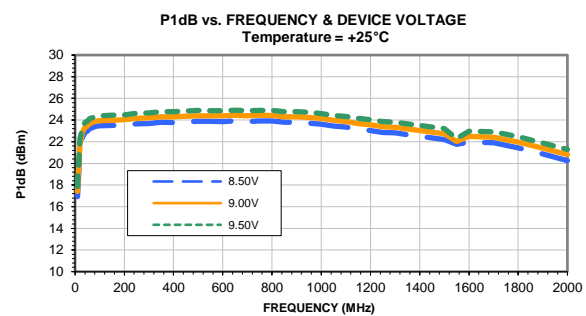
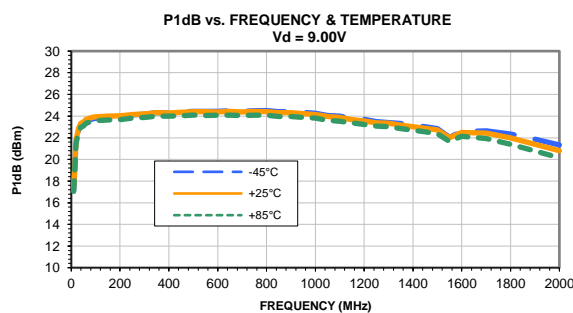
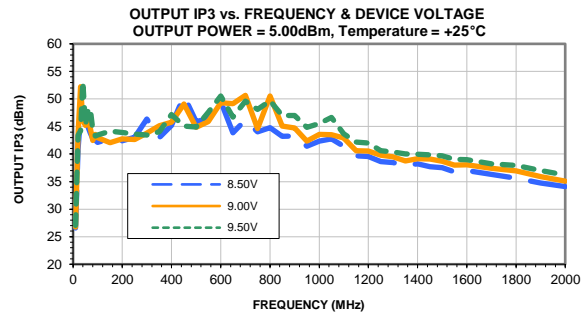
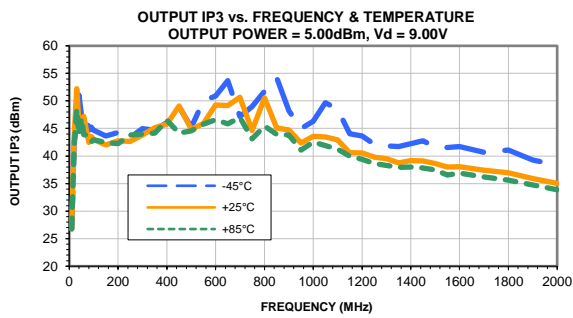

Typical Performance Curves

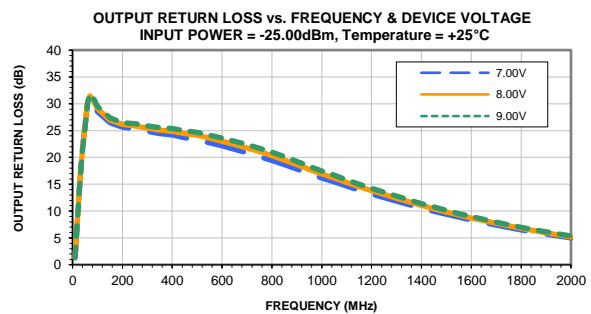
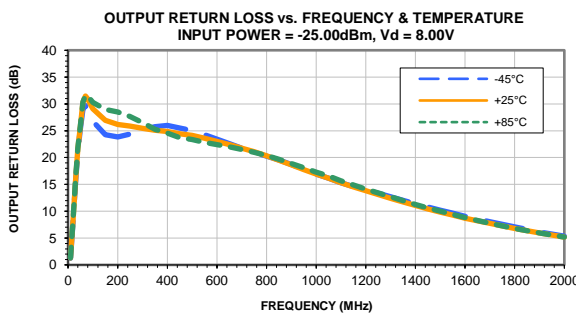
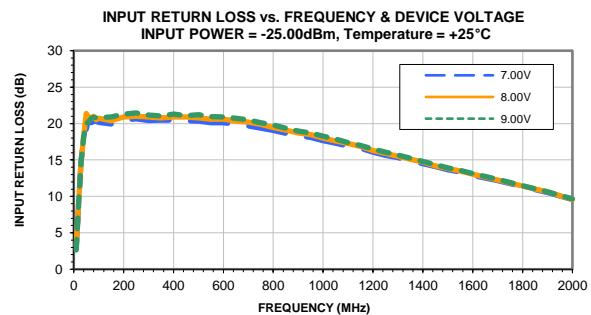
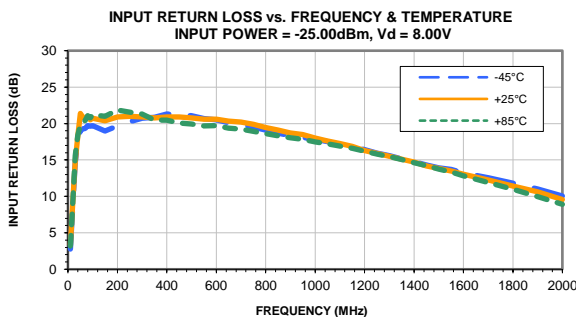
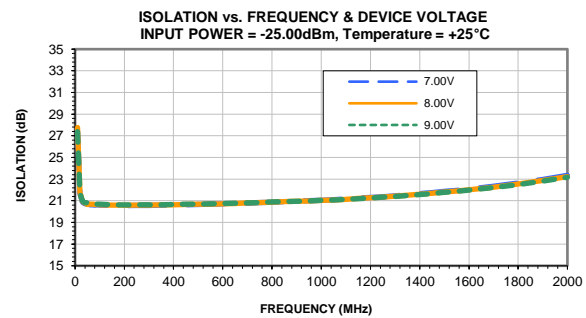
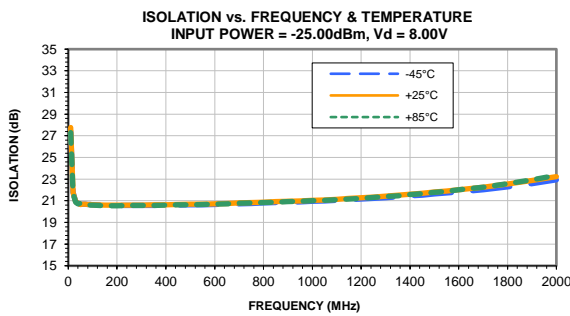
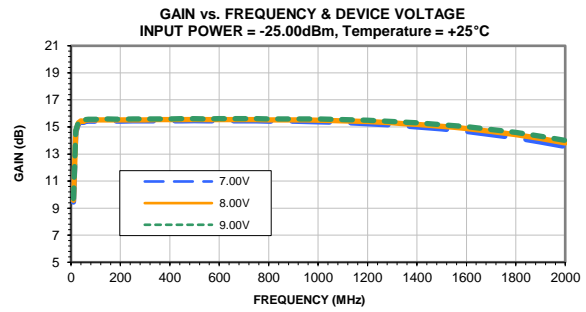
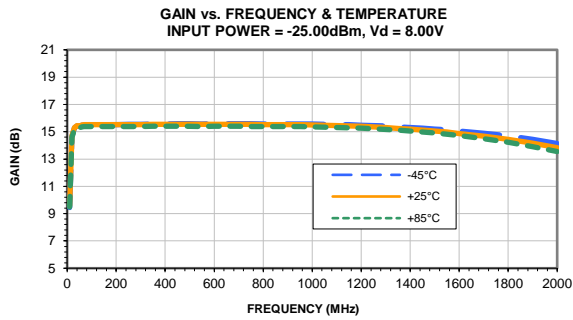

Typical Performance Curves

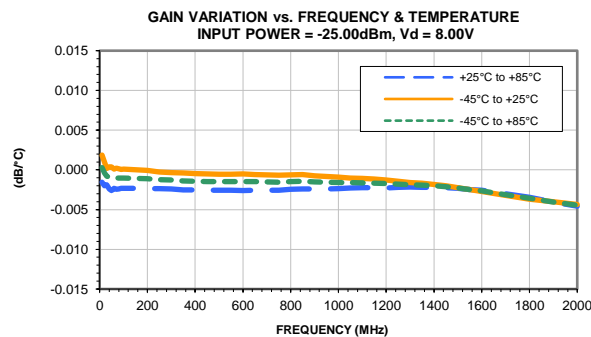
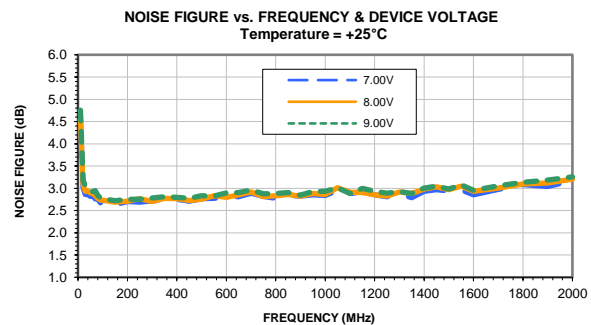
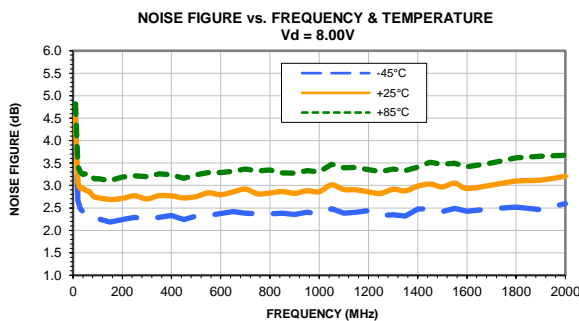
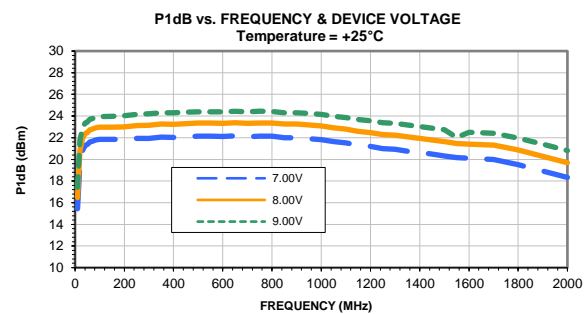
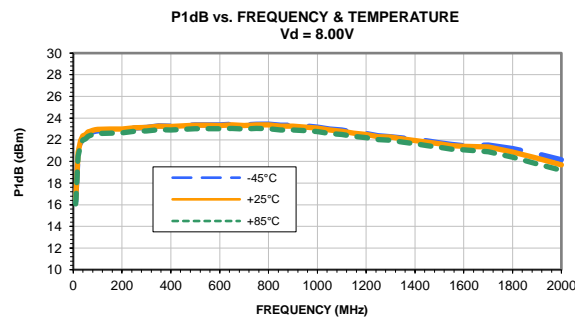
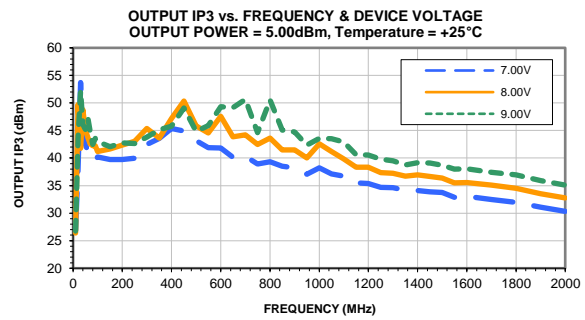
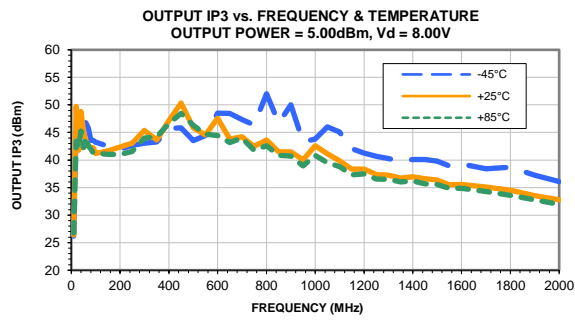

Outline Dimensions

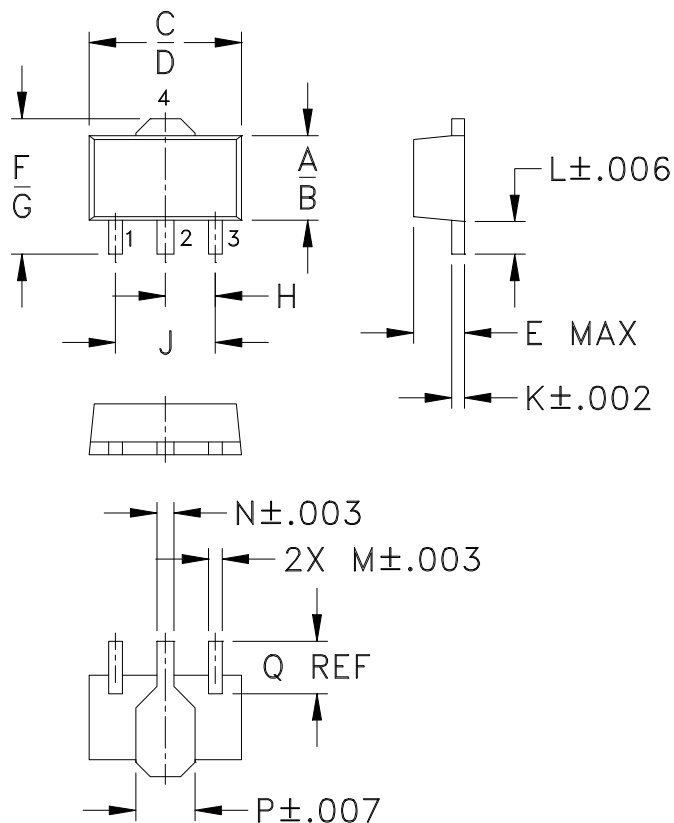

PCB Land Pattern

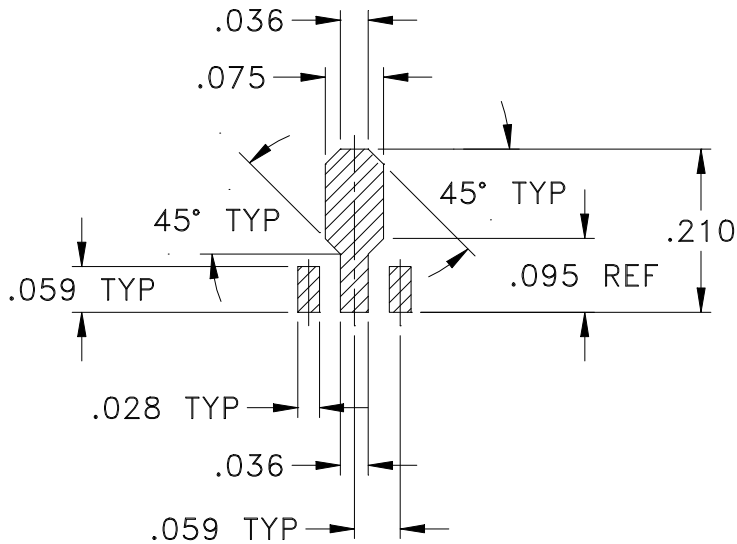

Suggested Layout,
Tolerance to be within $\pm .002$

CASE #	A	B	C	D	E	F	G	H	J	K	L	M
DF782	.102 (2.59)	.090 (2.29)	.181 (4.60)	.173 (4.39)	.063 (1.60)	.167 (4.24)	.155 (3.94)	.059 (1.50)	.118 (3.00)	.015 (0.38)	.041 (1.04)	.016 (0.41)

CASE #	N	P	Q	WT. GRAM
DF782	.019 (0.48)	.065 (1.65)	.062 (1.57)	.2

Dimensions are in inches (mm). Tolerances: 2 Pl. $\pm .01$; 3Pl. $\pm .005$

Notes:

- Case material: Plastic.
- Termination finish:
 For RoHS Case Styles: Tin-Silver alloy plate over Nickel barrier or Matte-Tin.
 All models, (+) suffix. See model Data sheet.
 For RoHS-5 Case Styles: Tin-Lead plate. All models, no (+) suffix.



INTERNET <http://www.minicircuits.com>

P.O. Box 350166, Brooklyn, New York 11235-0003 (718) 934-4500 Fax (718) 332-4661

Distribution Centers NORTH AMERICA 800-654-7949 • 417-335-5935 • Fax 417-335-5945 • EUROPE 44-1252-832600 • Fax 44-1252-837010

Mini-Circuits ISO 9001 & ISO 14001 Certified

Tape & Reel Packaging TR-F55

DEVICE ORIENTATION IN T&R

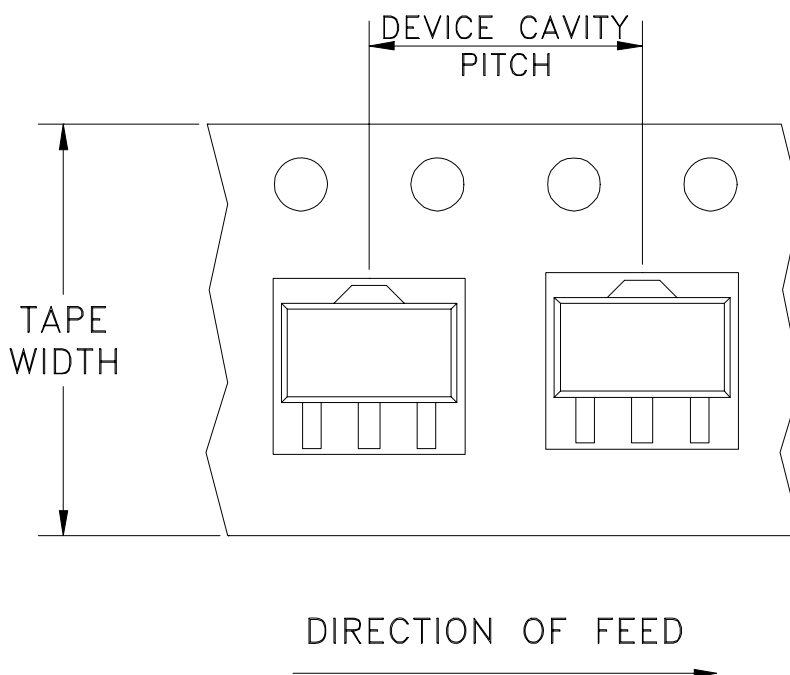

Tape Width, mm	Device Cavity Pitch, mm	Reel Size, inches	Devices per Reel	
12	8	7	Small quantity standard (see note)	20
				50
				100
				200
				500
			Standard	1000

Note: Please consult individual model data sheet to determine device per reel availability.

Mini-Circuits carrier tape materials provide protection from ESD (Electro-Static Discharge) during handling and transportation. Tapes are static dissipative and comply with industry standards EIA-481/EIA-541.

Go to: www.minicircuits.com/pages/pdfs/tape.pdf



INTERNET <http://www.minicircuits.com>

P.O. Box 350166, Brooklyn, New York 11235-0003 (718) 934-4500 Fax (718) 332-4661

Distribution Centers NORTH AMERICA 800-654-7949 • 417-335-5935 • Fax 417-335-5945 • EUROPE 44-1252-832600 • Fax 44-1252-837010

Mini-Circuits ISO 9001 & ISO 14001 Certified

THIRD ANGLE PROJECTION

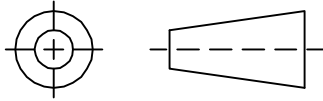

REVISIONS

REV	ECN No.	DESCRIPTION	DATE	DR	AUTH
OR	M154679	NEW RELEASE	01/20/16	GF	RS

**SUGGESTED MOUNTING CONFIGURATION FOR
DF782 CASE STYLE, "04AM03" PIN CODE**

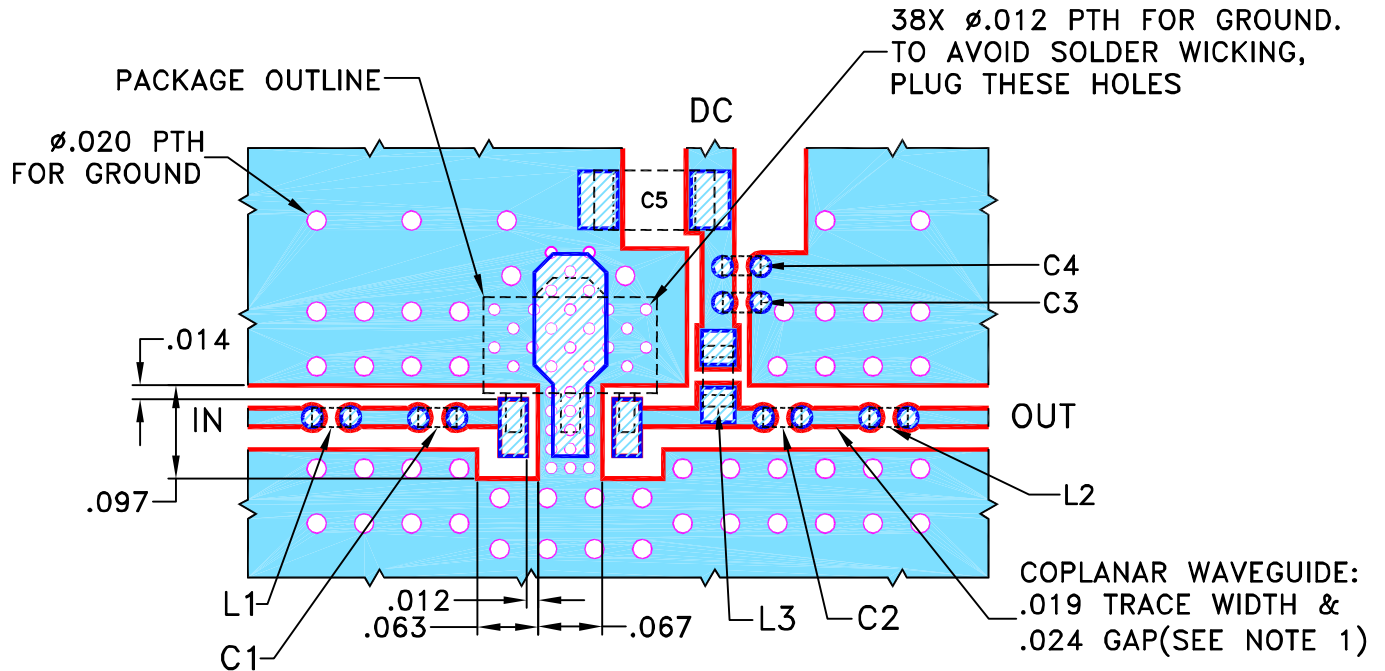

COMPONENT	SIZE
L1, L2, C1-C4	0402
L3	0603
C5	1206

NOTES:

- TRACE WIDTH PARAMETERS ARE SHOWN FOR ROGERS R04350B WITH DIELECTRIC THICKNESS $.020 \pm .0015$ ". COPPER: 1/2 OZ. EACH SIDE. FOR OTHER MATERIALS TRACE WIDTH MAY NEED TO BE MODIFIED.
- BOTTOM SIDE OF THE PCB IS CONTINUOUS GROUND PLANE.

 DENOTES PCB COPPER LAYOUT WITH SMOBC (SOLDER MASK OVER BARE COPPER).
 DENOTES COPPER LAND PATTERN FREE OF SOLDER MASK.

UNLESS OTHERWISE SPECIFIED	INITIALS	DATE
DRAWN	GF	01/15/16
CHECKED	IL	01/20/16
APPROVED	RS	01/20/16

 **Mini-Circuits®** 13 Neptune Avenue
Brooklyn NY 11235

PL, 04AM03, DF782, TB-850+

THIS DOCUMENT AND ITS CONTENTS ARE THE PROPERTY OF MINI-CIRCUITS. EXCEPT FOR USE EXPRESSLY GRANTED, IN WRITING, TO ITS VENDORS, VENDEE AND THE UNITED STATES GOVERNMENT, MINI-CIRCUITS RESERVES ALL PROPRIETARY DESIGN, USE, MANUFACTURING AND REPRODUCTION RIGHTS THERETO. THESE CONTENTS SHALL NOT BE USED, DUPLICATED OR DISCLOSED TO ANY OUTSIDE PARTY, IN WHOLE OR IN PART, WITHOUT WRITTEN PERMISSION OF MINI-CIRCUITS.

SIZE	CODE IDENT	DRAWING NO:	REV:
A	15542	98-PL-477	OR
FILE:	98PL477	SCALE:	SHEET:
ASHEETA1.DWG REV:A DATE:01/12/95		5:1	1 OF 1

Evaluation Board and Circuit

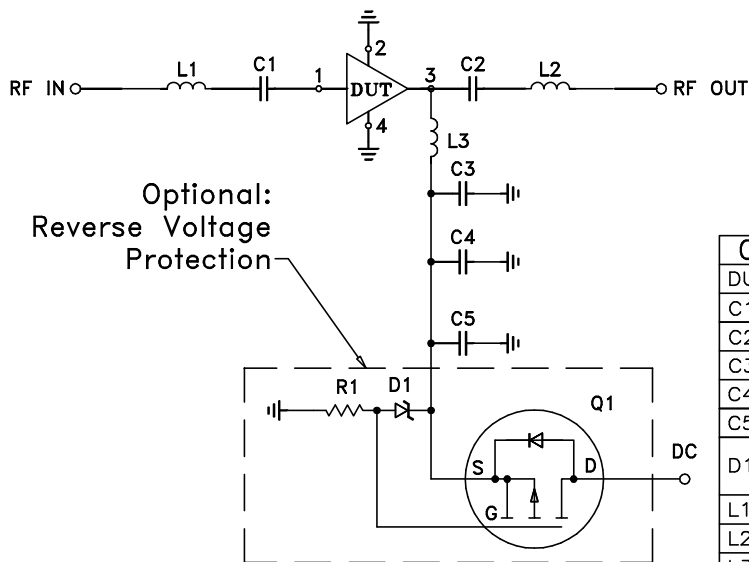
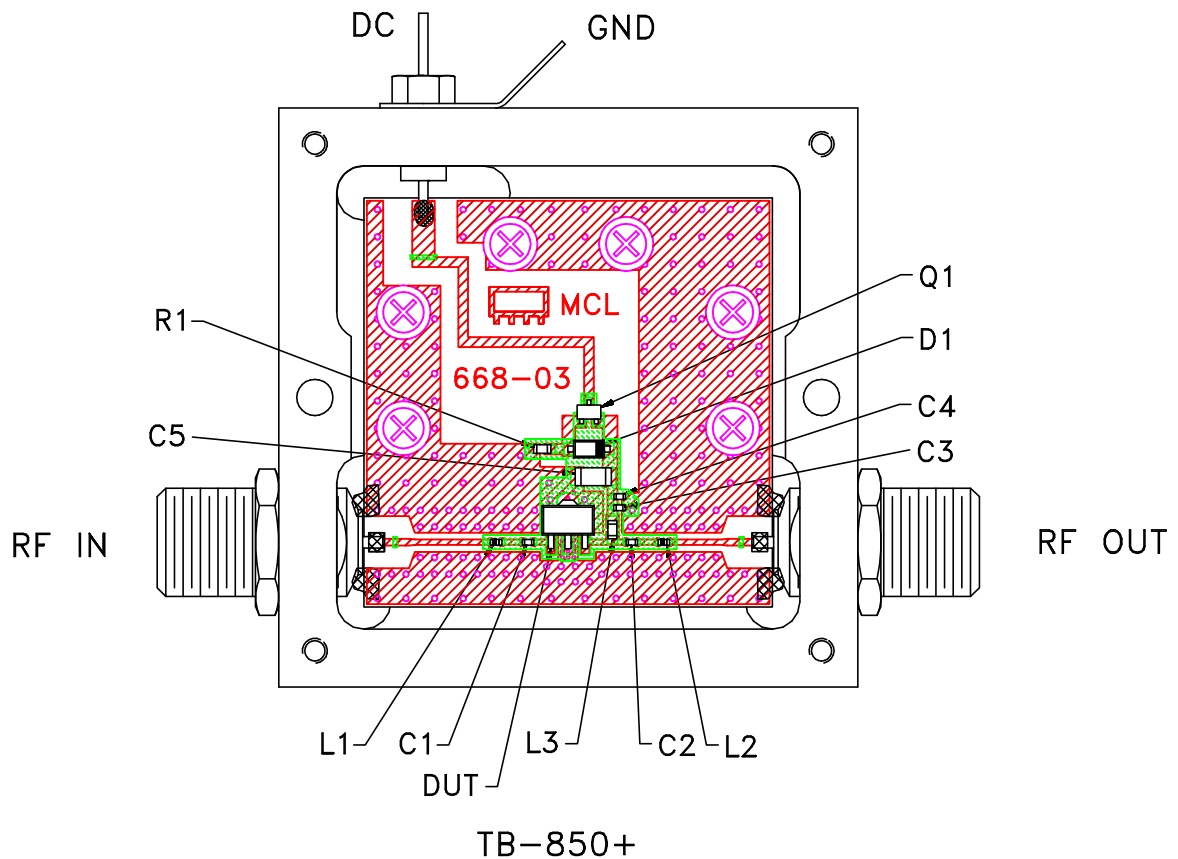

COMPONENT	VALUE	SIZE
DUT	PGA-122-75+	-
C1	1000 pF	0402
C2	120 pF	
C3	100 pF	
C4	10000 pF	1206
C5	10 uF, 25V	
D1	Zener Diode 5.6V ONSEMI MMSZ4690T1G	SOD123
L1	3.3 nH	0402
L2	4.7 nH	
L3	560 nH	0603
R1	1.5 kOhm	
Q1	Transistor ONSEMI FET NTS4101P	SOT323

Schematic Diagram

Notes:

1. 75 Ohm F-type Female connectors.
2. PCB Material: R04350 or equivalent,
Dielectric Constant=3.5, Thickness=.020 inch.

 **Mini-Circuits®**

All Mini-Circuits products are manufactured under exacting quality assurance and control standards, and are capable of meeting published specifications after being subjected to any or all of the following physical and environmental test.

Specification	Test/Inspection Condition	Reference/Spec
Operating Temperature	-40° to 85°C or -45° to 85°C Ambient Environment	Individual Model Data Sheet
Storage Temperature	-55° to 100° C or -65° to 150° Ambient Environment	Individual Model Data Sheet
Thermal Shock	-55° to 100°C, 100 cycles	MIL-STD-202, Method 107, Condition A-3, except +100°C
Mechanical Shock	1.5Kg, 0.5 ms, 5 shock pulses, Y1 direction only	MIL-STD-883, Method 2002, Condition B, except Y1 direction only
Vibration (Variable Frequency)	50g peak	MIL-STD-883, Method 2007, Condition B
Autoclave	15 psig, 100% RH, 121°C, 96 hours	JESD22-A102, Condition C
HAST	130°C, 85% RH, 96 hours	JESD22-A110
Solderability	10X Magnification	J-STD-002, Para 4.2.5, Test S, 95% Coverage
Solder Reflow Heat	Sn-Pb Eutetic Process: 240°C peak Pb-Free Process: 260°C peak	J-STD-020, Table 4-1, 4-2 and 5-2; Figure 5-1
Moisture Sensitivity: Level 1	Bake at 125°C for 24 hours Soak at 85°C/85% RH for 168 hours, Reflow 3 cycles at 260°C peak	J-STD-020
Marking Resistance to Solvents	Isopropyl alcohol + mineral spirits at 25°C; terpene defluxer at 25°C; distilled water + proylene glycol monomethyl ether +	MIL-STD-202, Method 215



All Mini-Circuits products are manufactured under exacting quality assurance and control standards, and are capable of meeting published specifications after being subjected to any or all of the following physical and environmental test.

Specification	Test/Inspection Condition	Reference/Spec
	monoethanolamine at 63°C to 70°C	