

Main technical indicators(主要技术指标)	
1.Mating (插拔次数)	5000
2.Working Temperature (温度)	-55~+150 °C
3.IP Rating (防护级别)	IP 50
4.Diameter of socket end(插合端直径)	φ0.9
5.Testing Voltage (测试电压)	1450V
6.Working Voltage (工作电压)	1000V
7.Rated Current (额定电流)	9A
8.Shell material(壳体材质)	Brass (chromium plating) shell and chuck nut/(nickel plating) pin sleeve and middleware/黄铜(镀铬)外壳和夹头螺母/(镀镍)插销套和中间件
9.Pin Material(插针材料)	Copper alloy gold plating(铜合金镀金)
10.Insulator material(绝缘体材质)	L:PPS P:PEEK

Sum up(总结)	
Series(系列)	B
Shell style/model (外壳样式/型号)	TGG: Straight plug, cable collet and nut for fitting a bend relief直塞、电缆夹头和螺母, 用于安装弯曲凸起
Button (按键)	A button(一个按键)
Termination type (终止类型)	Male solder(公焊锡)
Line diameter awg(线材直径)	30-22AWG
Cable diameterφ (电缆直径)	φ9.9-11MM
Matching parts(配件)	ZGG.3B.P12.CXL

Location pin combination(定位销组合)					
(编号) Number	Number of positioning pins(定位销数量)	Angle(角度)	Series(系列)--3B		
G	One(1)		(Zero degrees)0°		
A	Two(2)	A	Thirty degrees(30°)		
B	Two(2)		Forty-five degrees(45°)		
C	Two(2)		Sixty degrees(60°)		
D	Two(2)	γ	95 degrees (95°)		
E	Two(2)	β	120 degrees(120°)		
F	Two(2)		145 degrees(145°)		
J	Two(2)	A	37.5degrees(37.5°)		
K	Two(2)		52.5degrees(52.5°)		
L	Two(2)		Seventy degrees(70°)		
	A	B	C√	ANGLE	
5-10	±0.02	±0.05	±0.1	0°-30°	±0.1°
50-100	±0.1	±0.15	±0.2	61°-90°	±0.5°
50-100	±0.15	±0.2	±0.25		
100-	±0.15%	±0.20%	±0.25%		

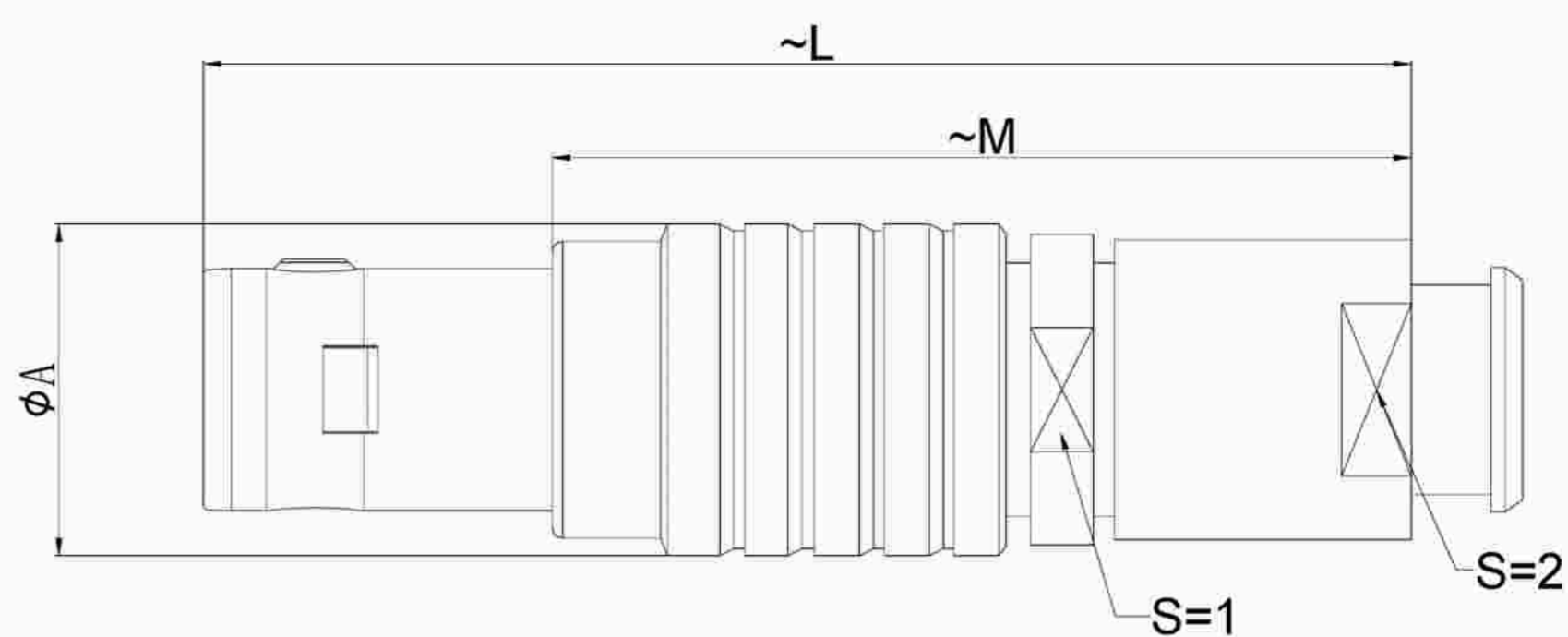

	A	L	M	S1	S2
MM	φ18	57	41.5	16.0	15
in	0.7087	2.2441	1.6339	0.6299	0.5906

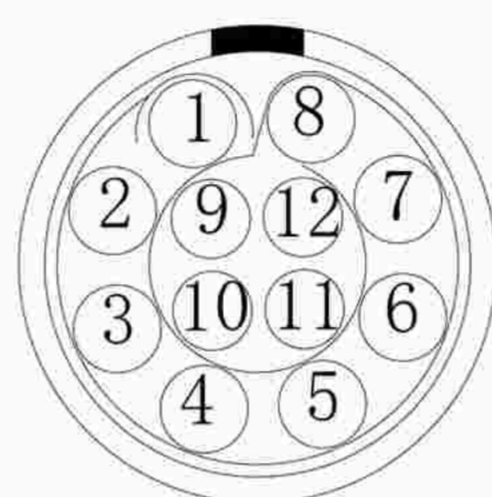

Welded surface (焊接面)

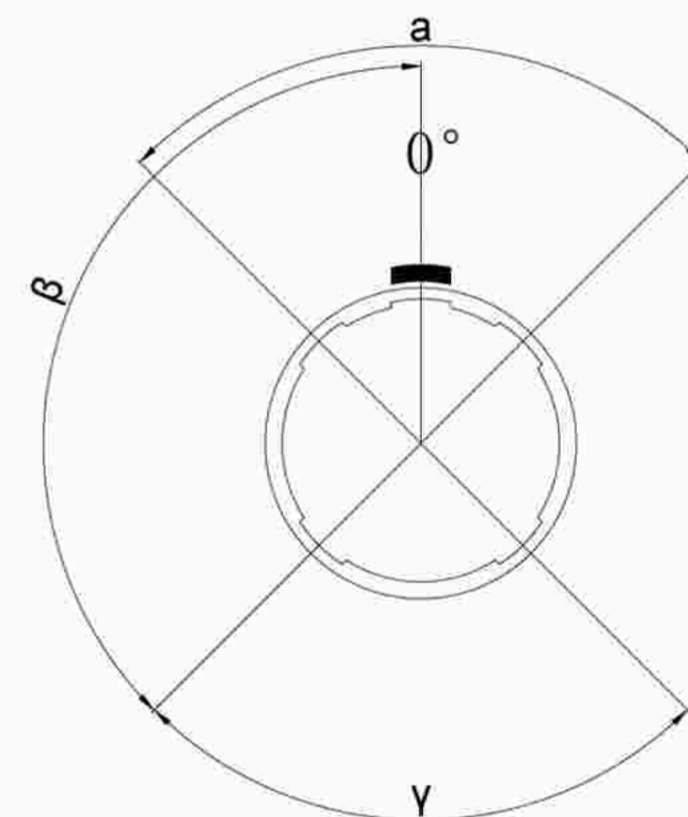

Positive view (正视图)

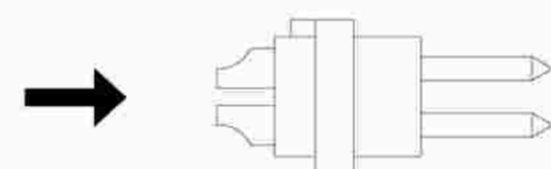

Solder core (焊接型公胶芯)

TG G. 3B. P12.C X A D 11 H

- Model(型号)
 - Positioning pin(定位销)
 - Series(系列)
 - Needle core configuration(针芯配置)
 - Outer casing(外壳)
 - Insulator(绝缘体)
 - Needle core(针芯)
 - Type of CXamp(线夹类型)
 - Cable diameter(电缆直径)
- SH means a sheath type, not a cover type.
(H表示护套型, 不表示为不带护套型)

DESIGNED(设计)
广东星坤科技股份有限公司
CHECKED(校对)

APPROVED(审核)
日期

REVISIONS

文件工程章

www.helloxkb.com www.helloxkb.cn

DATE(日期)	SCALE(比例)	N/A(不适用)
DATE(日期)	VIEW(视图)	
DATE(日期)	UNIT(单位)	MM
MATERIAL (材料)		

MODEL TYPE		
型号类型: TGG.3B.P12.CXAD11H		
PART NO.	3B12-core plug	
名称:	3B12芯插头	
DWG NO.:		
WEIGHT(重量)	SHEET(表)	REVISION(修订)
	1/1	A0