

THIS DOCUMENT IS THE PROPERTY OF
KEYSTONE ELECTRONICS CORP. AND
SHALL NOT BE REPRODUCED, DISTRIBUTED
OR USED AS A BASIS FOR MANUFACTURE
WITHOUT PRIOR WRITTEN PERMISSION
FROM KEYSTONE ELECTRONICS CORP.

ACTUAL SIZE

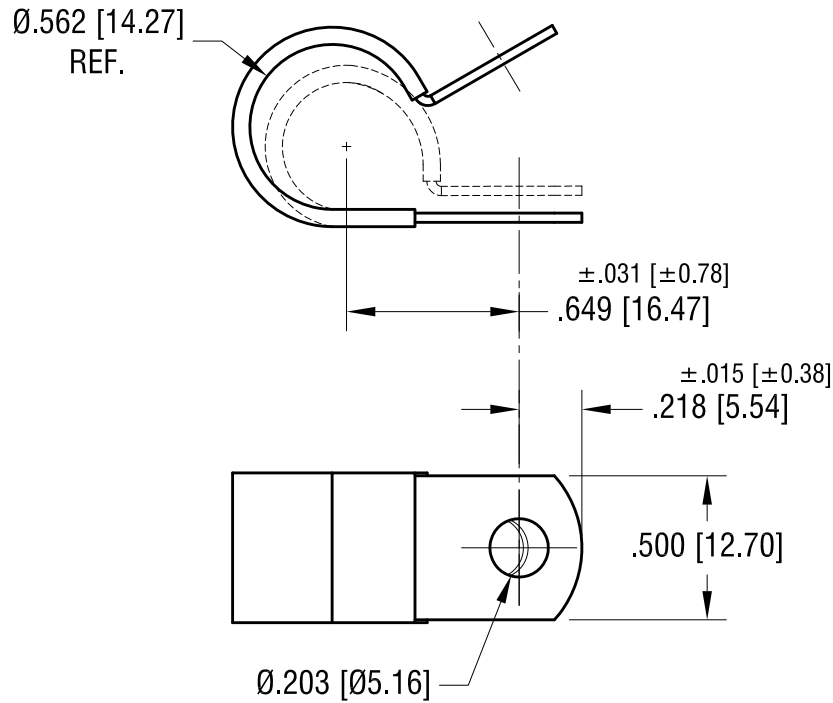
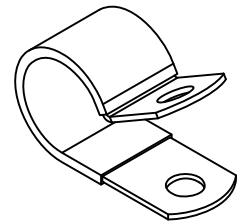

KEYSTONE ELECTRONICS CORP.

www.keyelco.com • NEW HYDE PARK, NY 11040 • Tel (516) 328-7500

PART NAME

INSULATED STEEL CABLE CLAMP

MATERIAL

.032 [0.81] TH'K STEEL, BLACK VINYL

FINISH

ZINC PLATE
CLEAR CHROMATE

DRN BY

BOONE

DATE

10.20.99

APP'D

RH

SCALE

1.5X

TOLERANCES

INCH [MM]

DECIMAL

$\pm .010$ [$\pm .025$]

ANGULAR $\pm 1^\circ$

UNLESS OTHERWISE SPECIFIED

CODE

C

DWG NO.

8127

2.27.24 CHANGE AS PER PCN 24-015

B

10.18.06 CHANGE AS PER ECN 06-070

A

DATE

DESCRIPTION

REV.