

# NA1-PK3 SERIES

**New**

Compact Size Picking Sensor **Anti-absentmindedness**



SF1-F  
Individual Beam Outputs

NA2-N  
Slim Body

NA1-11  
Slim Body

NA1-PK5/5  
Picking

NA1-PK3  
Picking



Boasts a compact, pocket lighter size enabling universal installation

Refer to p.419~ for the light curtain.



**Space-saving, pocket lighter-sized unit**

Ultra compact size: W24×H70×D8 mm  
W0.945×H2.756×D0.315 in. Can even be mounted within the small space constraints of parts containers.



**Utilizes a large, bright, clearly visible job indicator**

The ultra compact body incorporates a job indicator approximately 50 mm 1.969 in tall. Due to its brightness and high visibility, it is now possible to check sensor operation from a distance.

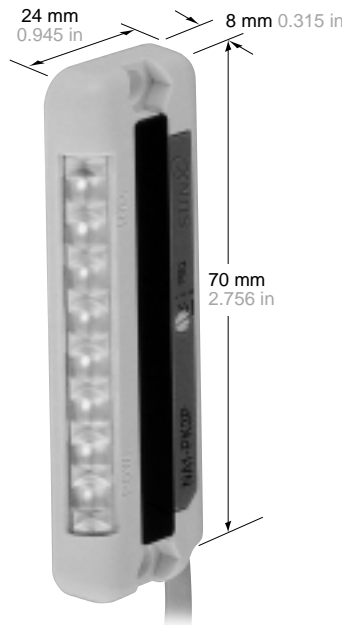

**No synchronization wires required**

Synchronization wires are not required, due to the utilization of a synchronized scanning system that results in a reduction of wiring man-hours. In addition, the sensors can be switched among three different emission frequencies, allowing up to three sets of sensors to be installed closely together in the same vertical plane, without causing mutual interference. Even when installed in multistage shelving, malfunctions due to mutual interference will not occur. (When mounted horizontally, a maximum of two sensor sets may be used side-by-side, without interference.)



**Switchable output operation**

Output operation can be switched to suit the desired application.

## APPLICATIONS

### Cell production line



### Assembly line



**WARNING** Never use this product in any personnel safety application.

### Easy alignment

The sensor's beam axis is directly in line with the mounting holes, making sensor alignment very easy. Mounting can be performed simply by using M4 nuts.

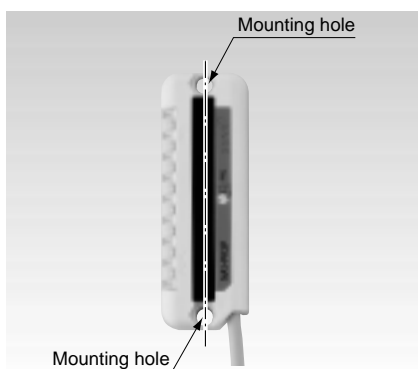

### Flexible cable orientation

The cabling can be oriented in either of two different directions: down or to the side, thus permitting a flexible layout, in accordance with the sensor's mounting position.



### Sensor protection brackets are available

Sensor protection brackets are now available (optional), to protect sensors from damage due to tools and other objects. The protection brackets have a black coating, which enhances the visual effectiveness of the job indicator.



# NA1-PK3

## ORDER GUIDE

Type	Appearance	Sensing range (Note)	Model No.	Output
NPN output		30 to 300 mm 1.181 to 11.811 in	<b>NA1-PK3</b>	NPN open-collector transistor
PNP output			<b>NA1-PK3-PN</b>	PNP open-collector transistor

Note: The sensing range is the possible setting distance between the emitter and the receiver. The sensor can detect an object less than 30 mm 1.181 in away.

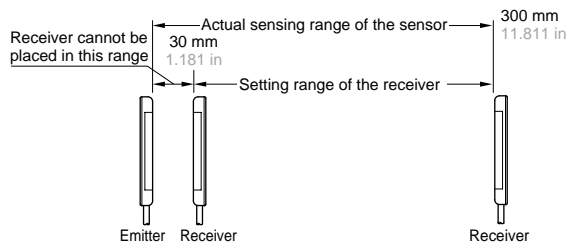

### 5 m 16.404 ft cable length type, pigtailed type

5 m 16.404 ft cable length type (standard: 2 m 6.562 ft) and pigtailed type (standard: cable type) are available.

#### • Table of Model Nos.

Type	Standard type	5 m 16.404 ft cable length type	Pigtailed type (Note)
NPN output	<b>NA1-PK3</b>	<b>NA1-PK3-C5</b>	<b>NA1-PK3-J</b>
PNP output	<b>NA1-PK3-PN</b>	<b>NA1-PK3-PN-C5</b>	<b>NA1-PK3-PN-J</b>

Note: Please order the suitable mating cable separately for pigtailed type.

#### • Mating cable (2 cables are required.)

Model No.	Description
<b>CN-24-C2</b>	4-core, cable length 2 m 6.562 ft
<b>CN-24-C5</b>	4-core, cable length 5 m 16.404 ft

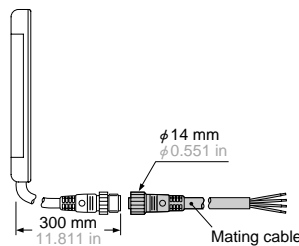

## OPTIONS

Designation	Model No.	Description
Sensor protection bracket	<b>MS-NA3-3</b>	It protects the sensor body. Two black bracket set (Four M4 (length 15 mm 0.591 in) screws with washers, and four nuts are attached.)
Y-shaped connector	<b>SL-WY</b> 5 pcs. per set	This connector is able to combine the cables of receiver and emitter into one.

### Sensor protection bracket

#### • MS-NA3-3



Two bracket set  
Four M4 (length 15 mm 0.591 in) screws with washers, and four nuts are attached.

### Y-shaped connector

#### • SL-WY

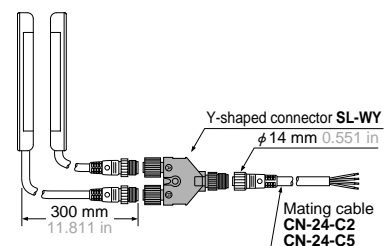

## SPECIFICATIONS

Type		NPN output	PNP output		
Item	Model No.	NA1-PK3	NA1-PK3-PN		
Sensing height		49.2 mm 1.937 in			
Sensing range (Note 1)		30 to 300 mm 1.181 to 11.811 in			
Beam pitch		24.6 mm 0.969 in			
Number of beam channels		3 beam channels			
Sensing object		φ29 mm φ1.142 in or more opaque object			
Supply voltage		12 to 24 V DC ± 10 % Ripple P-P 10 % or less			
Current consumption		Emitter: 30 mA or less, Receiver: 50 mA or less			
Output		NPN open-collector transistor	PNP open-collector transistor		
		<ul style="list-style-type: none"> <li>• Maximum sink current: 100 mA</li> <li>• Applied voltage: 30 V DC or less (between output and 0 V)</li> <li>• Residual voltage: 1 V or less (at 100 mA sink current) 0.4V or less (at 16 mA sink current)</li> </ul>	<ul style="list-style-type: none"> <li>• Maximum source current: 100 mA</li> <li>• Applied voltage: 30 V DC or less (between output and + V)</li> <li>• Residual voltage: 1 V or less (at 100 mA source current) 0.4 V or less (at 16 mA source current)</li> </ul>		
		Utilization category		DC-12 or DC-13	
		Output operation		ON or OFF when one or more beam channels are interrupted, selectable by operation mode switch	
Short-circuit protection		Incorporated			
Response time		10 ms or less (when interference prevention function is used: 30 ms or less)			
Indicators	Emitter	Power indicator: Green LED (lights up when the power is ON) Job indicator: Orange LED (lights up when the job indicator input is Low)	Power indicator: Green LED (lights up when the power is ON) Job indicator: Orange LED (lights up when the job indicator input is High)		
	Receiver	Operation indicator: Red LED (lights up when output is ON) Stable incident beam indicator: Green LED (lights up when the all beam channels are stably received) Job indicator: Orange LED (lights up when the job indicator input is Low)	Operation indicator: Red LED (lights up when the output is ON) Stable incident beam indicator: Green LED (lights up when the all beam channels are stably received) Job indicator: Orange LED (lights up when the job indicator input is High)		
Interference prevention function		Incorporated (Up to 3 units can be mounted close together.)(Note 2)			
Environmental resistance	Pollution degree	3 (Industrial environment)			
	Protection	IP62 (IEC)			
	Ambient temperature	- 10 to + 55 °C + 14 to + 131 °F (No dew condensation or icing allowed), Storage: - 20 to + 70 °C - 4 to + 158 °F			
	Ambient humidity	35 to 85 % RH, Storage: 35 to 85 % RH			
	Ambient illuminance	Sunlight: 10,000 lx at the light-receiving face, Incandescent light: 3,000 lx at the light-receiving face			
	EMC	EN 50081-2, EN 50082-2, EN 60947-5-2			
	Voltage withstandability	1,000 V AC for one min. between all supply terminals connected together and enclosure			
	Insulation resistance	20 MΩ, or more, with 250 V DC megger between all supply terminals connected together and enclosure			
Vibration resistance	10 to 150 Hz frequency, 0.75 mm 0.030 in (5 G max.) amplitude in X, Y and Z directions for two hours each				
Shock resistance	500 m/s <sup>2</sup> acceleration (50 G approx.) in X, Y and Z directions for three times each				
Emitting element		Infrared LED (synchronized scanning system)			
Material		Enclosure: Heat-resistant ABS, Lens cover: Acrylic, Indicator cover: Acrylic			
Cable		0.2 mm <sup>2</sup> 4-core (emitter: 3-core) oil resistant cabtyre cable, 2 m 6.562 ft long			
Cable extension		Extension up to total 100 m 328.084 ft is possible for both emitter and receiver with 0.3 mm <sup>2</sup> , or more, cable.			
Weight		Emitter: 50 g approx., Receiver: 50 g approx.			

Individual Beam Outputs

SF1-F

Slim Body

NA2-N

NA1-11

Picking

NA1-PK5/5

NA1-PK3

Notes: 1) The sensing range is the possible setting distance between the emitter and the receiver. The sensor can detect an object less than 30 mm 1.181 in away.

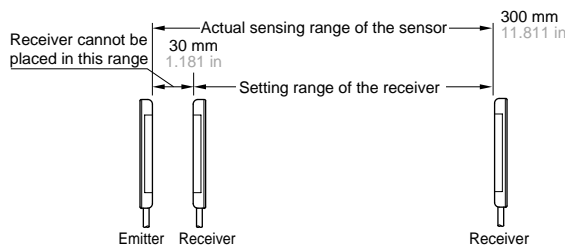

2) For more details, refer to the 'Interference prevention function' in 'PRECAUTIONS FOR PROPER USE' (p.551).

# NA1-PK3

## I/O CIRCUIT AND WIRING DIAGRAMS

### NPN output type

#### I/O circuit diagram

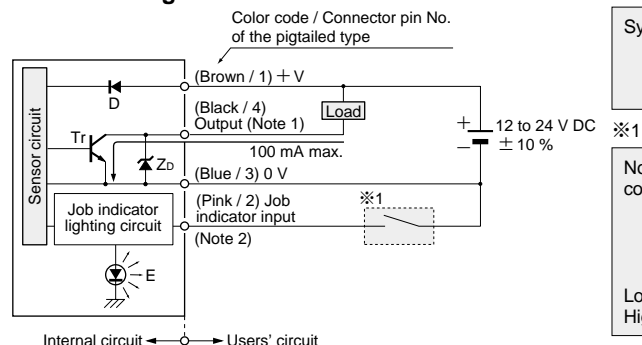

Symbols ... D : Reserve supply polarity protection diode  
Zd : Surge absorption zener diode  
Tr : NPN output transistor  
E : Job indicator (IND.)

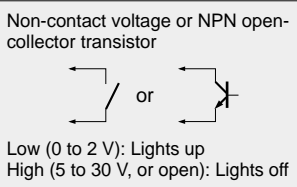

#### Connector pin position (Pigtailed type)

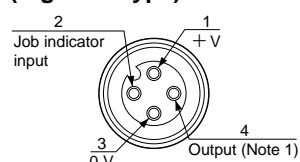

Notes: 1) No connection is required for the emitter.  
2) The pin position for the SL-WY Y-shaped connector (optional) is identical to the receiver.

Notes: 1) The emitter does not incorporate the output.  
2) When the job indicator is used as a large size operation indicator, connect the job indicator input wire (pink) of the emitter and the receiver to the output wire (black) of the receiver.

### PNP output type

#### I/O circuit diagram

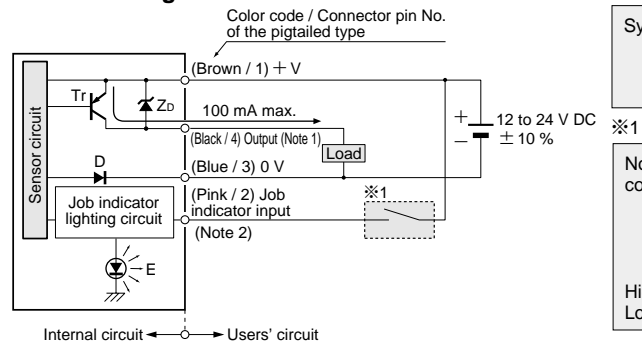

Symbols ... D : Reserve supply polarity protection diode  
Zd : Surge absorption zener diode  
Tr : PNP output transistor  
E : Job indicator (IND.)

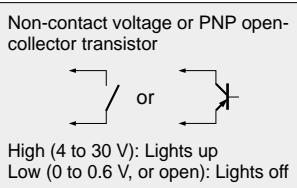

#### Connector pin position (Pigtailed type)

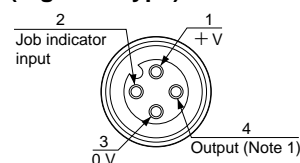

Notes: 1) No connection is required for the emitter.  
2) The pin position for the SL-WY Y-shaped connector (optional) is identical to the receiver.

Notes: 1) The emitter does not incorporate the output.  
2) When the job indicator is used as a large size operation indicator, connect the job indicator input wire (pink) of the emitter and the receiver to the output wire (black) of the receiver.

## SENSING CHARACTERISTICS (TYPICAL)

### Parallel deviation

#### Vertical direction

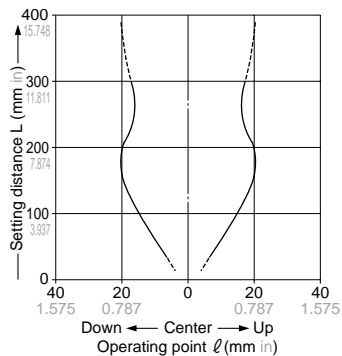
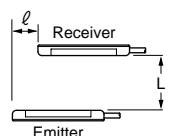

#### Horizontal direction

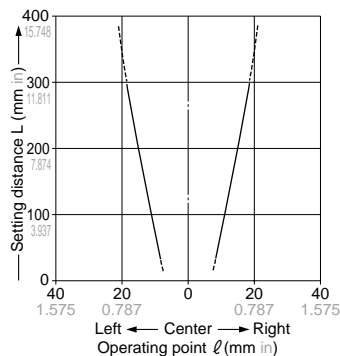
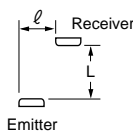

### Angular deviation

#### Vertical direction emitter angular deviation

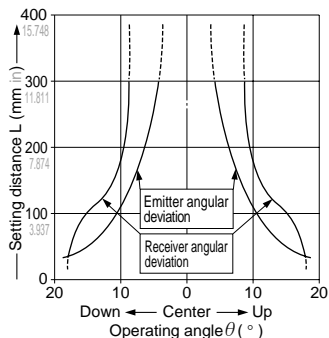
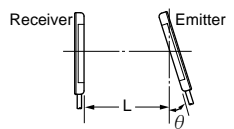

#### Horizontal direction emitter angular deviation

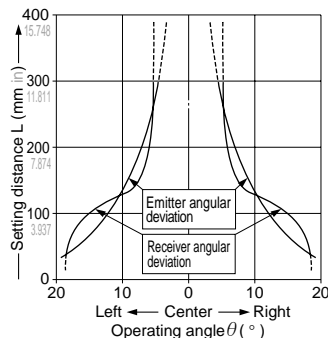
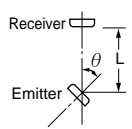

#### Vertical direction receiver angular deviation

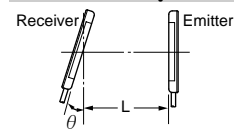

#### Horizontal direction receiver angular deviation

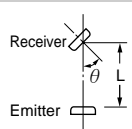

## PRECAUTIONS FOR PROPER USE

Refer to p.1135~ for general precautions.



- Never use this product as a sensing device for personnel protection.
- For sensing devices to be used as safety devices for press machines or for personnel protection, use products which meet standards, such as OSHA, ANSI or IEC etc., for personnel protection applicable in each region or country.
- If this product is used as a sensing device for personnel protection, death or serious body injury could result.
- For a product which meets safety standards, use the following products.  
Type 4: **SF4-AH** series (p.420~) **SF2-EH** series (p.486~)  
Type 2: **SF2-A** series (p.446~) **SF2-N** series (p.464~)

### Part description

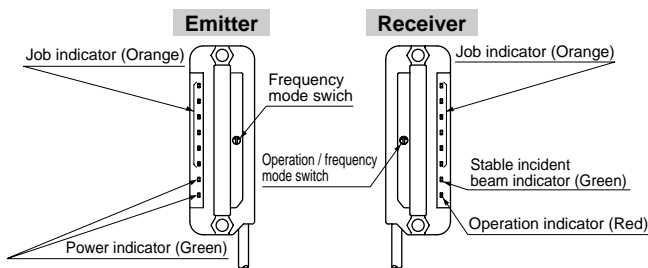

### Mounting

- Use M4 screws with washers and M4 nuts. The tightening torque should be 0.5 N·m or less.  
(Please arrange the screws and nuts separately.)

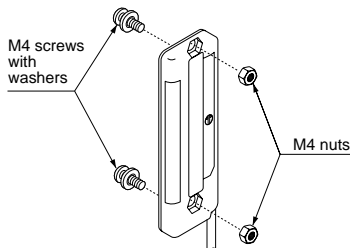

### Selection of operation

- The output operation can be selected by the operation / frequency selection switch on the receiver.  
(Make sure that the power supply is off while setting the selection switch.)

	State of operation / frequency selection switch	Output operation
L-ON	FREQ. 1 2 3 D-ON 1 2 3	OFF when one or more beams are interrupted.
	FREQ. 1 2 3 D-ON 1 2 3	ON when one or more beams are interrupted.

Notes: 1) Selection of the output operation and the frequency for the receiver is carried out with the same switch. When the output operation is set, be sure to select the same frequency No. of the emitter and the receiver.

2) In case the operation / frequency selection switch is set to the position other than 1, 2 or 3, the state of the receiver is in D-ON / frequency 1.

### Orientation

- The emitter and the receiver must face each other correctly. If they are set upside down, the sensor does not work.

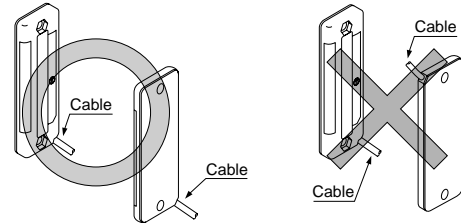

### Interference prevention function

- By setting different emission frequencies, three units of NA1-PK3 can be mounted close together, as shown in the figure on the below.

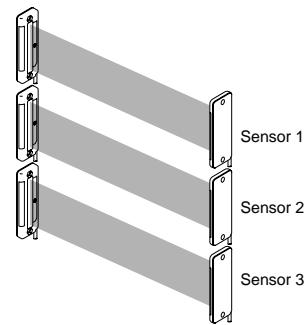

- However, if the sensors are mounted close together as shown in the figure below, up to 2 sets of sensors are possible.

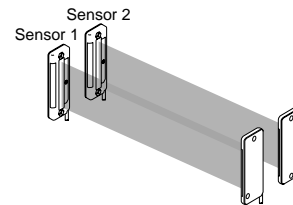

### Frequency setting

- Set the both emitting and receiving frequency of Sensor 1 to FREQ. 1, the both emitting and receiving frequency of Sensor 2 to FREQ. 2 and the both emitting and receiving frequency of Sensor 3 to FREQ. 3.  
(Make sure that the power supply is off while setting the selection switch.)

		Emitter	Receiver
		Frequency selection switch	Operation / Frequency selection switch
Sensor 1	L-ON	FREQ. 1 2 3	FREQ. 1 2 3 D-ON 1 2 3
	D-ON	FREQ. 1 2 3	FREQ. 1 2 3 D-ON 1 2 3
Sensor 2	L-ON	FREQ. 1 2 3	FREQ. 2 1 3 D-ON 1 2 3
	D-ON	FREQ. 1 2 3	FREQ. 2 1 3 D-ON 1 2 3
Sensor 3	L-ON	FREQ. 1 2 3	FREQ. 3 2 1 D-ON 1 2 3
	D-ON	FREQ. 1 2 3	FREQ. 3 2 1 D-ON 1 2 3

Notes: 1) Take care that selection of the output operation and the frequency for the receiver is carried out with the same switch.

2) In case the frequency switch and the operation / frequency selection switch is set to the position other than 1, 2 or 3, the state of the emitter is in frequency 1 and that of the receiver is in D-ON / frequency 1.

# NA1-PK3

## PRECAUTIONS FOR PROPER USE

Refer to p.1135~ for general precautions.

### Wiring

- Make sure that the power supply is off while wiring and setting the selection switch.
- Take care that wrong wiring may damage the sensor.
- Verify that the supply voltage variation is within the rating.
- If power is supplied from a commercial switching regulator, ensure that the frame ground (F.G.) terminal of the power supply is connected to an actual ground.
- In case noise generating equipment (switching regulator, inverter motor, etc.) is used in the vicinity of the sensor, connect the frame ground (F.G.) terminal of the equipment to an actual ground.
- Extension up to total 100 m 328.084 ft is possible with 0.3 mm<sup>2</sup>, or more, cable for both emitter and receiver. However, in order to reduce noise, make the wiring as short as possible.
- Do not run the wires together with high-voltage lines or power lines or put them in the same raceway. This can cause malfunction due to induction.
- Make sure to use an isolation transformer for the DC power supply. If an auto-transformer (single winding transformer) is used, this product or the power supply may get damaged.
- In case a surge is generated in the used power supply, connect a surge absorber to the supply and absorb the surge.

### Others

- Do not use during the initial transient time (0.5 sec.) after the power supply is switched on.
- Take care that the sensor is not directly exposed to fluorescent light from a rapid-starter lamp or a high frequency lighting device, as it may affect the sensing performance.
- Avoid dust, dirt, and steam.
- Take care that the product does not come in direct contact with water, oil, grease or organic solvents, such as, thinner, etc.
- To select the switch, a minus screwdriver is necessary. (Tip dimension: 2.5 × 0.6 mm 0.098 × 0.024 in)
- This sensor is suitable for indoor use only.

## DIMENSIONS (Unit: mm in)

The CAD data in the dimensions can be downloaded from the SUNX website: <http://www.sunx.co.jp/>

### NA1-PK3 NA1-PK3-PN Sensor

#### Emitter

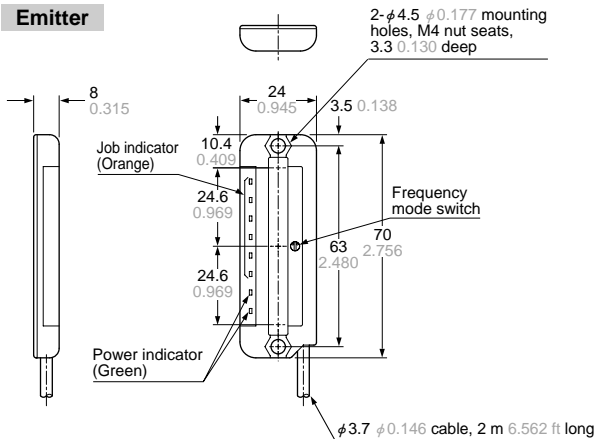

#### Receiver

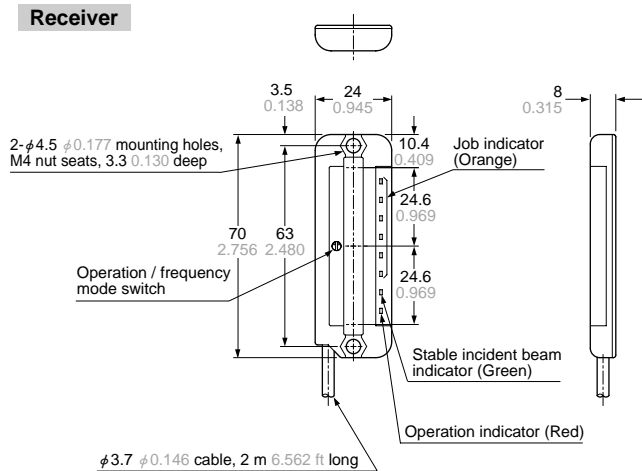

### MS-NA3-3 Sensor protection bracket (Optional)

Note: The sensor protection bracket can be used for both the emitter and the receiver.

Material: Cold rolled carbon steel (SPCC) (Black chromate)

Two bracket set  
[Four M4 (length 15 mm 0.591 in) screws with washers and four nuts are attached.]

