

ULN2003B High-Voltage, High-Current Darlington Transistor Array

1 Features

- Greater Than 4x Reduction in Output Leakage (I_{CEX}) over ULN2003A
- 500-mA Rated Collector Current (Single Output)
- High-Voltage Outputs 50 V
- Output Clamp Diodes
- Inputs Compatible With Various Types of Logic
- Relay-Driver Applications

2 Applications

- Relay Drivers
- Lamp Drivers
- Display Drivers (LED and Gas Discharge)
- Line Drivers
- Logic Buffers

3 Description

The ULN2003B device is a high-voltage, high-current Darlington transistor array. This device consists of seven NPN Darlington pairs that feature high-voltage outputs with common-cathode clamp diodes for switching inductive loads. The collector-current rating of a single Darlington pair is 500 mA. The Darlington pairs can be paralleled for higher current capability.

The ULN2003B has a 2.7-k Ω series base resistor for each Darlington pair for operation directly with TTL or CMOS devices.

Device Information⁽¹⁾

| PART NUMBER | PACKAGE | BODY SIZE (NOM) |
|-------------|------------|--------------------|
| ULN2003BN | PDIP (16) | 19.30 mm x 6.35 mm |
| ULN2003BD | SOIC (16) | 9.90 mm x 3.91 mm |
| ULN2003BPW | TSSOP (16) | 5.00 mm x 4.40 mm |

(1) For all available packages, see the orderable addendum at the end of the datasheet.

Simplified Schematic

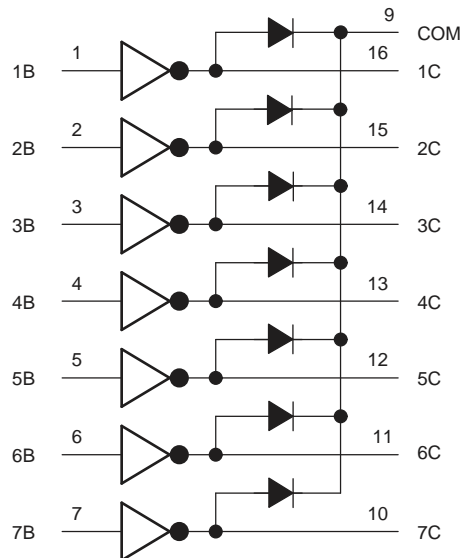

Copyright © 2016, Texas Instruments Incorporated



Table of Contents

| | | | |
|--|-----------|--|-----------|
| 1 Features | 1 | 8.2 Functional Block Diagram | 10 |
| 2 Applications | 1 | 8.3 Feature Description | 10 |
| 3 Description | 1 | 8.4 Device Functional Modes | 11 |
| 4 Revision History | 2 | 9 Application and Implementation | 11 |
| 5 Pin Configuration and Functions | 3 | 9.1 Application Information | 11 |
| 6 Specifications | 4 | 9.2 Typical Application | 11 |
| 6.1 Absolute Maximum Ratings | 4 | 10 Power Supply Recommendations | 13 |
| 6.2 ESD Ratings | 4 | 11 Layout | 13 |
| 6.3 Recommended Operating Conditions | 4 | 11.1 Layout Guidelines | 13 |
| 6.4 Thermal Information | 4 | 11.2 Layout Example | 13 |
| 6.5 Electrical Characteristics, $T_A = 25^\circ\text{C}$ | 5 | 12 Device and Documentation Support | 14 |
| 6.6 Electrical Characteristics, $T_A = -40^\circ\text{C}$ to $+105^\circ\text{C}$ | 5 | 12.1 Receiving Notification of Documentation Updates | 14 |
| 6.7 Switching Characteristics, $T_A = 25^\circ\text{C}$ | 5 | 12.2 Community Resources | 14 |
| 6.8 Switching Characteristics, $T_A = -40^\circ\text{C}$ to $+105^\circ\text{C}$ | 5 | 12.3 Trademarks | 14 |
| 6.9 Typical Characteristics | 6 | 12.4 Electrostatic Discharge Caution | 14 |
| 7 Parameter Measurement Information | 9 | 12.5 Glossary | 14 |
| 8 Detailed Description | 10 | 13 Mechanical, Packaging, and Orderable Information | 14 |
| 8.1 Overview | 10 | | |

4 Revision History

| Changes from Revision A (September 2014) to Revision B | Page |
|--|-----------|
| • Deleted Hammer Drivers from <i>Applications</i> | 1 |
| • Updated <i>Pin Functions</i> table | 3 |
| • Deleted Package Thermal Information from <i>Absolute Maximum Ratings</i> | 4 |
| • Moved Storage temperature, T_{stg} to <i>Absolute Maximum Ratings</i> | 4 |
| • Deleted V_I from <i>Recommended Operating Conditions</i> | 4 |
| • Updated <i>Thermal Information</i> table | 4 |
| • Moved Operating free-air temperature, T_A to <i>Recommended Operating Conditions</i> | 4 |
| • Deleted <i>Output Current vs Input Current</i> graph from <i>Typical Characteristics</i> section | 6 |
| • Added h_{FE} vs I_{OUT} to <i>Typical Characteristics</i> section | 6 |
| • Deleted <i>Thermal Information</i> graphs section and updated <i>Typical Characteristics</i> section with new thermal graphs Figure 6 through Figure 14 | 6 |
| • Added <i>Receiving Notification of Documentation Updates</i> section and <i>Community Resources</i> section | 14 |

| Changes from Original (June 2014) to Revision A | Page |
|---|----------|
| • Initial release of full version. | 1 |
| • Added Pin Functions table | 3 |
| • Added Thermal Information table | 4 |

5 Pin Configuration and Functions

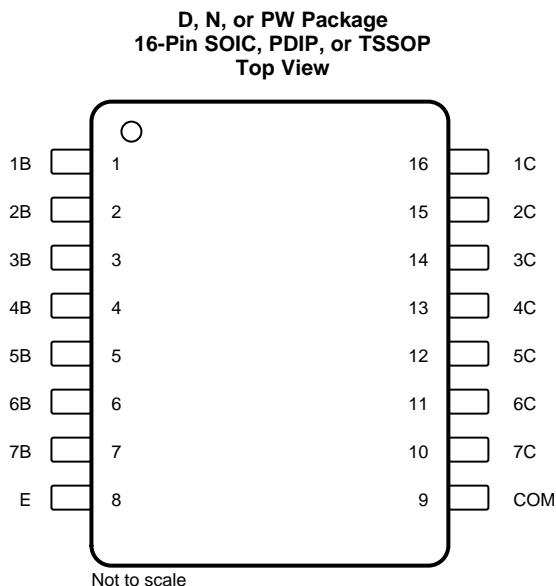

Pin Functions

| PIN | | I/O ⁽¹⁾ | DESCRIPTION |
|------|-----|--------------------|---|
| NAME | NO. | | |
| 1B | 1 | I | Channel 1 through 7 darlington base input |
| 2B | 2 | | |
| 3B | 3 | | |
| 4B | 4 | | |
| 5B | 5 | | |
| 6B | 6 | | |
| 7B | 7 | | |
| 1C | 16 | O | Channel 1 through 7 darlington collector output |
| 2C | 15 | | |
| 3C | 14 | | |
| 4C | 13 | | |
| 5C | 12 | | |
| 6C | 11 | | |
| 7C | 10 | | |
| COM | 9 | — | Common cathode node for flyback diodes (required for inductive loads) |
| E | 8 | — | Common Emmitter shared by all channels (typically tied to ground) |

(1) I = Input, O = Output

6 Specifications

6.1 Absolute Maximum Ratings

 at 25°C free-air temperature (unless otherwise noted)⁽¹⁾

| | MIN | MAX | UNIT |
|---|-----|------|------|
| V _{CC} Collector-emitter voltage | | 50 | V |
| Clamp diode reverse voltage ⁽²⁾ | | 50 | V |
| V _I Input voltage ⁽²⁾ | | 30 | V |
| Peak collector current ⁽³⁾⁽⁴⁾ | | 500 | mA |
| I _{OK} Output clamp current | | 500 | mA |
| Total emitter-terminal current | | –2.5 | A |
| T _J Operating virtual junction temperature | | 150 | °C |
| T _{stg} Storage temperature | –65 | 150 | °C |

- (1) Stresses beyond those listed under *Absolute Maximum Ratings* may cause permanent damage to the device. These are stress ratings only, which do not imply functional operation of the device at these or any other conditions beyond those indicated under *Recommended Operating Conditions*. Exposure to absolute-maximum-rated conditions for extended periods may affect device reliability.
- (2) All voltage values are with respect to the emitter/substrate terminal E, unless otherwise noted.
- (3) Maximum power dissipation is a function of T_J(max), θ_{JA}, and T_A. The maximum allowable power dissipation at any allowable ambient temperature is P_D = (T_J(max) – T_A)/θ_{JA}. Operating at the absolute maximum T_J of 150°C can affect reliability.
- (4) The package thermal impedance is calculated in accordance with JEDEC 51-7.

6.2 ESD Ratings

| | VALUE | UNIT |
|--|--|------|
| V _(ESD) Electrostatic discharge | Human body model (HBM), per ANSI/ESDA/JEDEC JS-001 ⁽¹⁾ | 2000 |
| | Charged device model (CDM), per JEDEC specification JESD22-C101 ⁽²⁾ | 500 |

- (1) JEDEC document JEP155 states that 500-V HBM allows safe manufacturing with a standard ESD control process.
- (2) JEDEC document JEP157 states that 250-V CDM allows safe manufacturing with a standard ESD control process.

6.3 Recommended Operating Conditions

over operating free-air temperature range (unless otherwise noted)

| | MIN | MAX | UNIT |
|---|-----|-----|------|
| V _{CC} Supply Voltage | 0 | 50 | V |
| T _A Operating free-air temperature | –40 | 105 | °C |
| T _J Junction Temperature | –40 | 125 | °C |

6.4 Thermal Information

| THERMAL METRIC ⁽¹⁾ | ULN2003B | | | UNIT |
|---|------------|----------|----------|------|
| | PW (TSSOP) | D (SOIC) | N (PDIP) | |
| | 16 PINS | 16 PINS | 16 PINS | |
| R _{θJA} Junction-to-ambient thermal resistance | 105.5 | 81.2 | 49.6 | °C/W |
| R _{θJC(top)} Junction-to-case (top) thermal resistance | 38.3 | 40 | 36.2 | °C/W |
| R _{θJB} Junction-to-board thermal resistance | 50.9 | 38.6 | 29.2 | °C/W |
| ψ _{JT} Junction-to-top characterization parameter | 4.1 | 10.5 | 20.2 | °C/W |
| ψ _{JB} Junction-to-board characterization parameter | 50.3 | 38.3 | 29.5 | °C/W |

- (1) For more information about traditional and new thermal metrics, see the [Semiconductor and IC Package Thermal Metrics](#) application report.

6.5 Electrical Characteristics, $T_A = 25^\circ\text{C}$

| PARAMETER | | TEST FIGURE | TEST CONDITIONS | | MIN | TYP | MAX | UNIT |
|----------------------|--------------------------------------|-------------|----------------------------|--------------------------|-----|------|------|---------------|
| $V_{I(\text{on})}$ | On-state input voltage | Figure 19 | $V_{CE} = 2\text{ V}$ | $I_C = 200\text{ mA}$ | | | 2.4 | V |
| | | | | $I_C = 250\text{ mA}$ | | | 2.7 | |
| | | | | $I_C = 300\text{ mA}$ | | | 3 | |
| $V_{CE(\text{sat})}$ | Collector-emitter saturation voltage | Figure 18 | $I_I = 250\ \mu\text{A}$, | $I_C = 100\text{ mA}$ | | 0.9 | 1.1 | V |
| | | | $I_I = 350\ \mu\text{A}$, | $I_C = 200\text{ mA}$ | | 1 | 1.3 | |
| | | | $I_I = 500\ \mu\text{A}$, | $I_C = 350\text{ mA}$ | | 1.2 | 1.6 | |
| I_{CEX} | Collector cutoff current | Figure 15 | $V_{CE} = 50\text{ V}$, | $I_I = 0$ | | | 10 | μA |
| V_F | Clamp forward voltage | Figure 21 | $I_F = 350\text{ mA}$ | | | 1.7 | 2 | V |
| $I_{I(\text{off})}$ | Off-state input current | Figure 16 | $V_{CE} = 50\text{ V}$, | $I_C = 500\ \mu\text{A}$ | 50 | 65 | | μA |
| I_I | Input current | Figure 17 | $V_I = 3.85\text{ V}$ | | | 0.93 | 1.35 | mA |
| I_R | Clamp reverse current | Figure 20 | $V_R = 50\text{ V}$ | | | | 50 | μA |
| C_i | Input capacitance | | $V_I = 0$, | $f = 1\text{ MHz}$ | | 15 | 25 | pF |

6.6 Electrical Characteristics, $T_A = -40^\circ\text{C}$ to $+105^\circ\text{C}$

| PARAMETER | | TEST FIGURE | TEST CONDITIONS | | MIN | TYP | MAX | UNIT |
|----------------------|--------------------------------------|-------------|----------------------------|--------------------------|-----|------|------|---------------|
| $V_{I(\text{on})}$ | On-state input voltage | Figure 19 | $V_{CE} = 2\text{ V}$ | $I_C = 200\text{ mA}$ | | | 2.7 | V |
| | | | | $I_C = 250\text{ mA}$ | | | 2.9 | |
| | | | | $I_C = 300\text{ mA}$ | | | 3 | |
| $V_{CE(\text{sat})}$ | Collector-emitter saturation voltage | Figure 18 | $I_I = 250\ \mu\text{A}$, | $I_C = 100\text{ mA}$ | | 0.9 | 1.2 | V |
| | | | $I_I = 350\ \mu\text{A}$, | $I_C = 200\text{ mA}$ | | 1 | 1.4 | |
| | | | $I_I = 500\ \mu\text{A}$, | $I_C = 350\text{ mA}$ | | 1.2 | 1.7 | |
| I_{CEX} | Collector cutoff current | Figure 15 | $V_{CE} = 50\text{ V}$, | $I_I = 0$ | | | 20 | μA |
| V_F | Clamp forward voltage | Figure 21 | $I_F = 350\text{ mA}$ | | | 1.7 | 2.2 | V |
| $I_{I(\text{off})}$ | Off-state input current | Figure 16 | $V_{CE} = 50\text{ V}$, | $I_C = 500\ \mu\text{A}$ | 30 | 65 | | μA |
| I_I | Input current | Figure 17 | $V_I = 3.85\text{ V}$ | | | 0.93 | 1.35 | mA |
| I_R | Clamp reverse current | Figure 20 | $V_R = 50\text{ V}$ | | | | 100 | μA |
| C_i | Input capacitance | | $V_I = 0$, | $f = 1\text{ MHz}$ | | 15 | 25 | pF |

6.7 Switching Characteristics, $T_A = 25^\circ\text{C}$

| PARAMETER | | TEST CONDITIONS | | MIN | TYP | MAX | UNIT |
|-----------|---|-----------------------|-----------------------------|------------|------|-----|---------------|
| t_{PLH} | Propagation delay time, low- to high-level output | | | | 0.25 | 1 | μs |
| t_{PHL} | Propagation delay time, high- to low-level output | | | | 0.25 | 1 | μs |
| V_{OH} | High-level output voltage after switching | $V_S = 50\text{ V}$, | $I_O \approx 300\text{ mA}$ | $V_S - 20$ | | | mV |

6.8 Switching Characteristics, $T_A = -40^\circ\text{C}$ to $+105^\circ\text{C}$

| PARAMETER | | TEST CONDITIONS | | MIN | TYP | MAX | UNIT |
|-----------|---|-----------------------|-----------------------------|------------|-----|-----|---------------|
| t_{PLH} | Propagation delay time, low- to high-level output | | | | 1 | 10 | μs |
| t_{PHL} | Propagation delay time, high- to low-level output | | | | 1 | 10 | μs |
| V_{OH} | High-level output voltage after switching | $V_S = 50\text{ V}$, | $I_O \approx 300\text{ mA}$ | $V_S - 50$ | | | mV |

6.9 Typical Characteristics

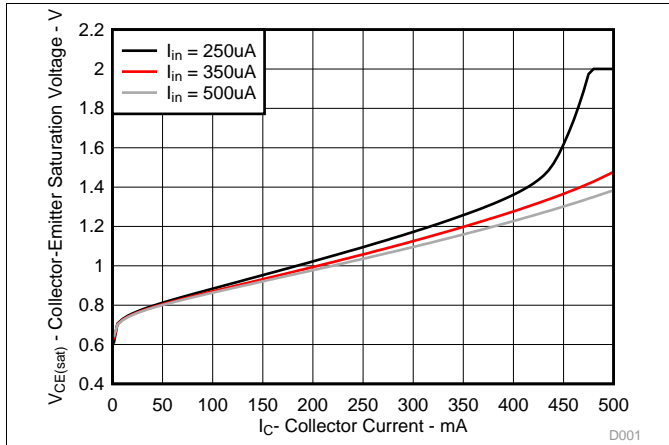

Figure 1. Collector-Emitter Saturation Voltage vs Collector Current (One Darlington)

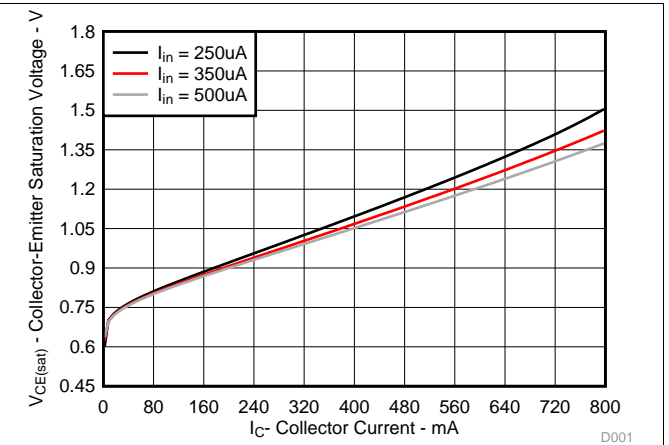

Figure 2. Collector-Emitter Saturation Voltage vs Total Collector Current (Two Darlington in Parallel)

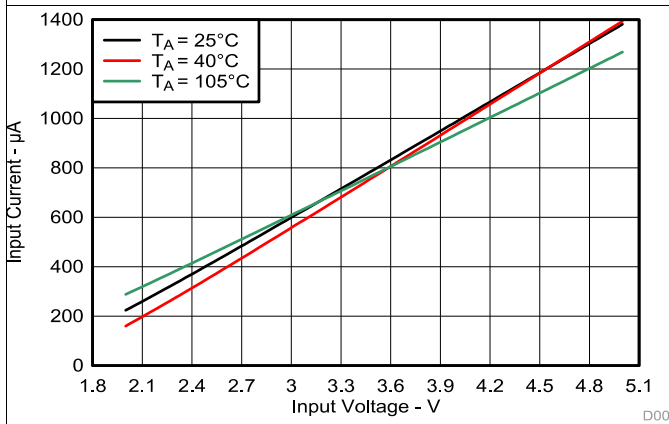

Figure 3. Input Current vs Input Voltage

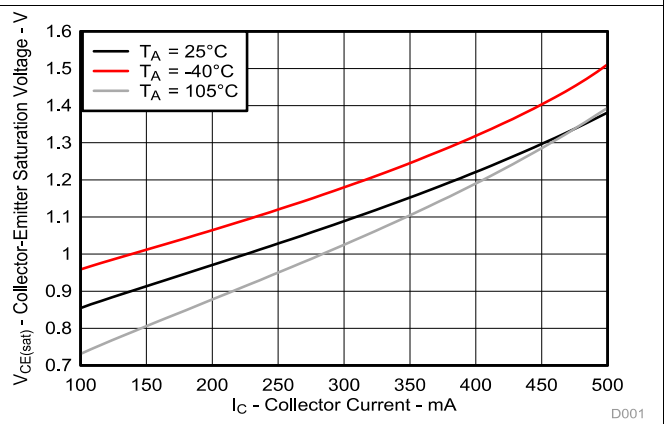

Figure 4. Collector-Emitter Saturation Voltage vs Collector Current

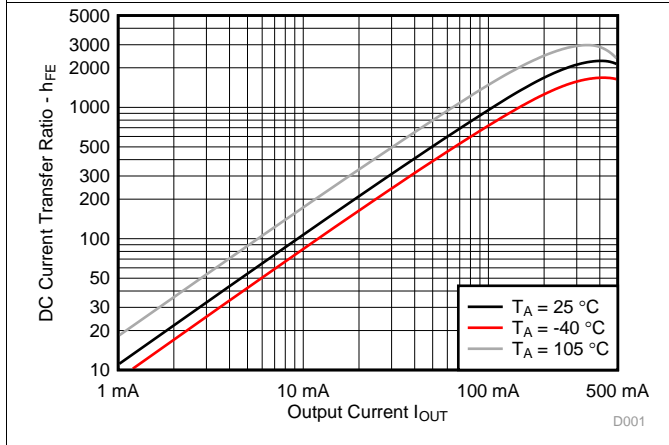

Figure 5. h_{FE} vs I_{OUT}

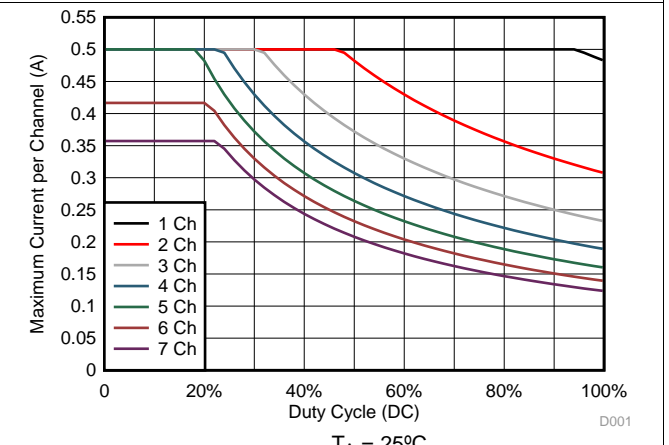

Figure 6. D Package Maximum Collector Current vs Duty Cycle

Typical Characteristics (continued)

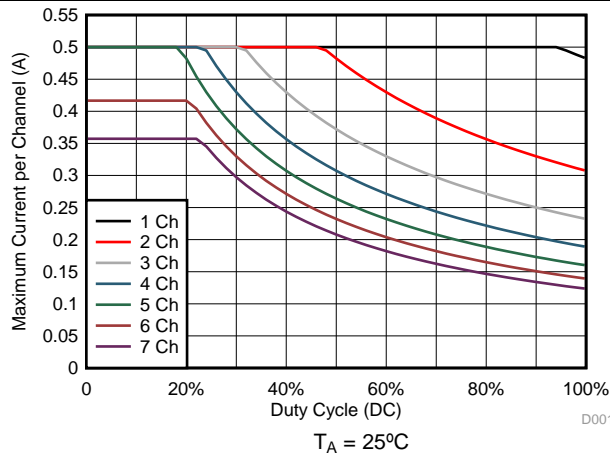

Figure 7. PW Package Maximum Collector Current vs Duty Cycle

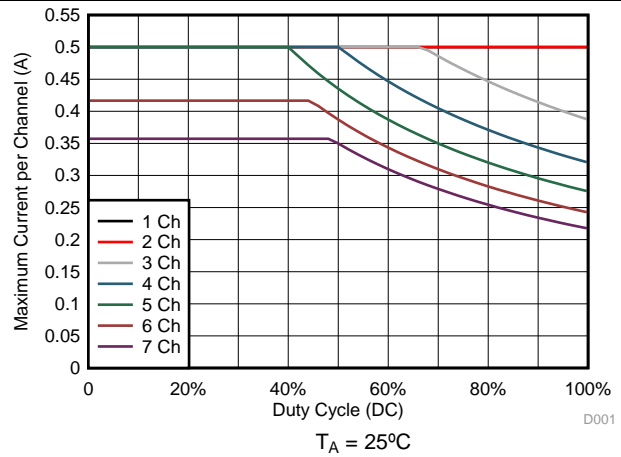

Figure 8. N Package Maximum Collector Current vs Duty Cycle

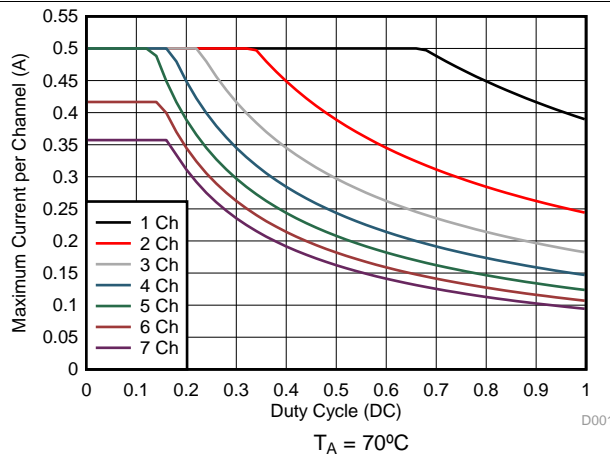

Figure 9. D Package Maximum Collector Current vs Duty Cycle

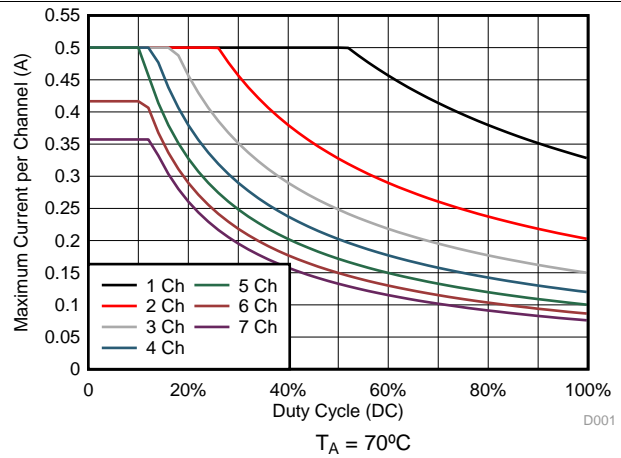

Figure 10. PW Package Maximum Collector Current vs Duty Cycle

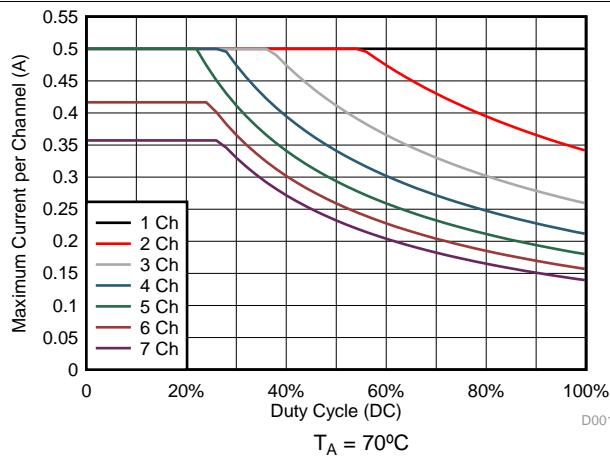

Figure 11. N Package Maximum Collector Current vs Duty Cycle

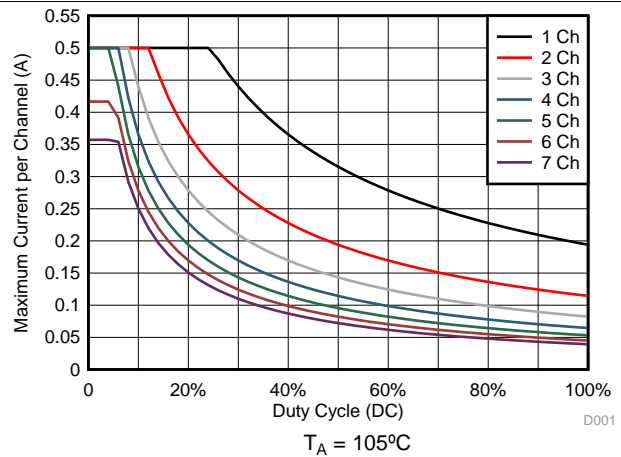
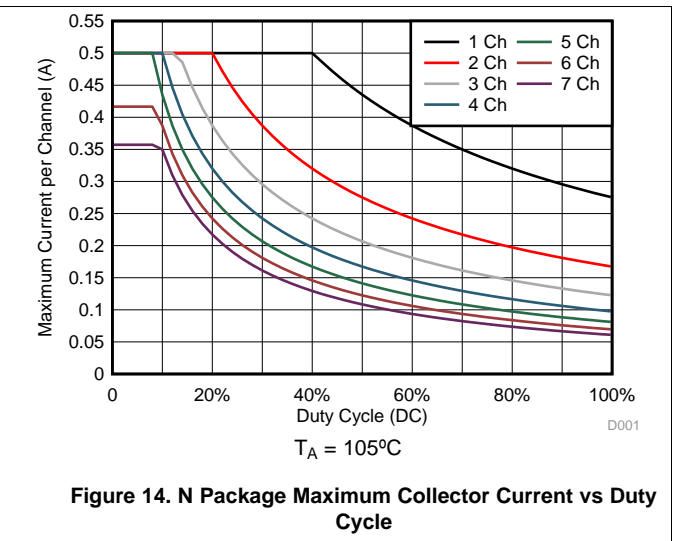
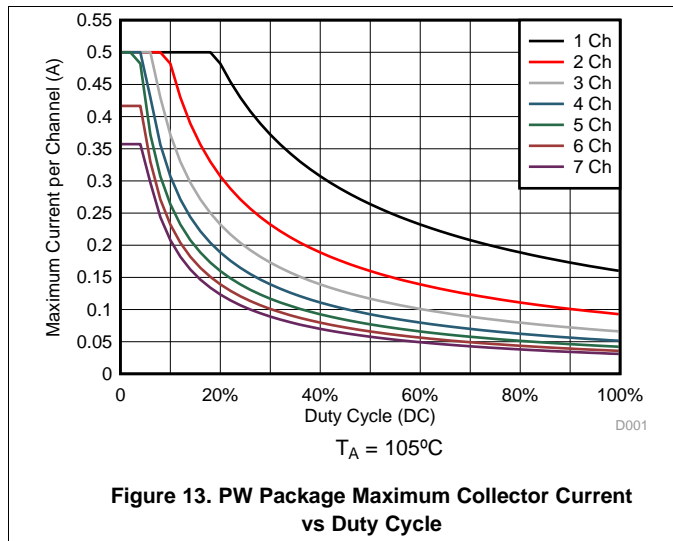

Figure 12. D Package Maximum Collector Current vs Duty Cycle

Typical Characteristics (continued)



7 Parameter Measurement Information

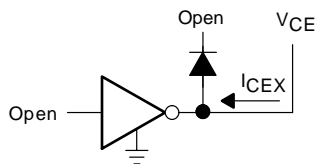

Figure 15. I_{CEX} Test Circuit

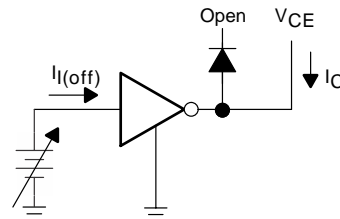

Figure 16. $I_{I(off)}$ Test Circuit

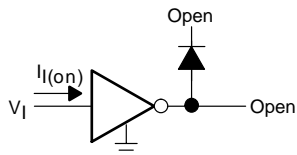

Figure 17. I_I Test Circuit

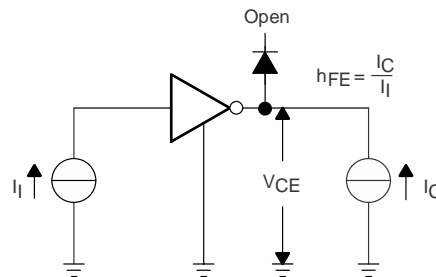

Figure 18. h_{fe} , $V_{CE(sat)}$ Test Circuit

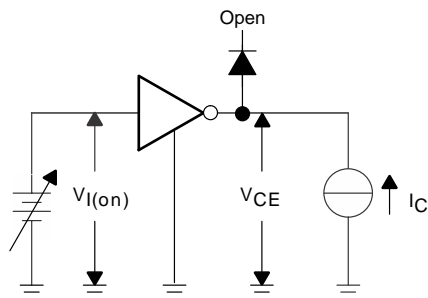

Figure 19. $V_{I(on)}$ Test Circuit

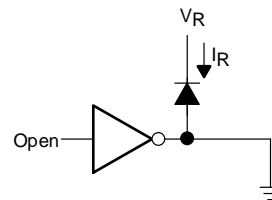

Figure 20. I_R Test Circuit

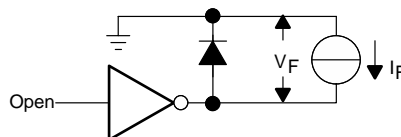

Figure 21. V_F Test Circuit

8 Detailed Description

8.1 Overview

This standard device has proven ubiquity and versatility across a wide range of applications. This is due to its integration of 7 Darlington transistors that are capable of sinking up to 500 mA and wide GPIO range capability.

The ULN2003B comprises seven high voltage, high current NPN Darlington transistor pairs. All units feature a common emitter and open collector outputs. To maximize their effectiveness, these units contain suppression diodes for inductive loads. The ULN2003B has a series base resistor to each Darlington pair, thus allowing operation directly with TTL or CMOS operating at supply voltages of 5 V or 3.3 V. The ULN2003B offers solutions to a great many interface needs, including solenoids, relays, lamps, small motors, and LEDs. Applications requiring sink currents beyond the capability of a single output may be accommodated by paralleling the outputs.

This device can operate over a wide temperature range (–40°C to +105°C).

8.2 Functional Block Diagram

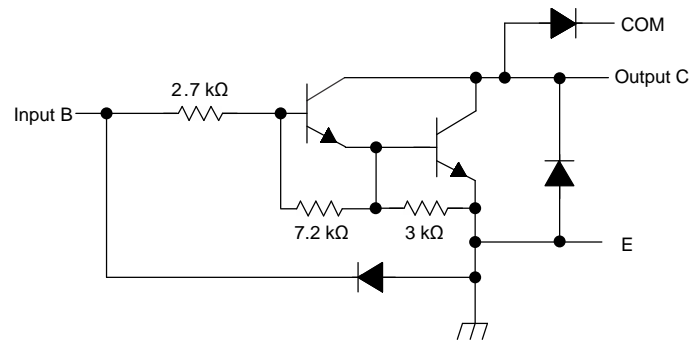

Copyright © 2016, Texas Instruments Incorporated

All resistor values shown are nominal.

Figure 22. Schematic (Each Driver)

8.3 Feature Description

Each channel of ULN2003B consists of Darlington connected NPN transistors. This connection creates the effect of a single transistor with a very high current gain. This beta can be high at certain currents see [Figure 5](#).

The GPIO voltage is converted to base current through the 2.7-kΩ resistor connected between the input and base of the pre-driver Darlington NPN. The 7.2-kΩ and 3-kΩ resistors connected between the base and emitter of each respective NPN act as pull-downs and suppress the amount of leakage that may occur from the input.

The diodes connected between the output and COM pin is used to suppress the kick-back voltage from an inductive load that is excited when the NPN drivers are turned off (stop sinking) and the stored energy in the coils causes a reverse current to flow into the coil supply through the kick-back diode.

In normal operation the diodes on base and collector pins to emitter will be reversed biased. If these diodes are forward biased, internal parasitic NPN transistors will draw (a nearly equal) current from other (nearby) device pins.

8.4 Device Functional Modes

8.4.1 Inductive Load Drive

When the COM pin is tied to the coil supply voltage, ULN2003B is able to drive inductive loads and suppress the kick-back voltage through the internal free wheeling diodes.

8.4.2 Resistive Load Drive

When driving a resistive load, a pull-up resistor is needed in order for ULN2003B to sink current and for there to be a logic high level. The COM pin can be left floating for these applications.

9 Application and Implementation

NOTE

Information in the following applications sections is not part of the TI component specification, and TI does not warrant its accuracy or completeness. TI's customers are responsible for determining suitability of components for their purposes. Customers should validate and test their design implementation to confirm system functionality.

9.1 Application Information

ULN2003B will typically be used to drive a high voltage and/or current peripheral from an MCU or logic device that cannot tolerate these conditions. The following design is a common application of ULN2003B, driving inductive loads. This includes motors, solenoids and relays. Figure 23 is a typical block diagram representation of this application.

9.2 Typical Application

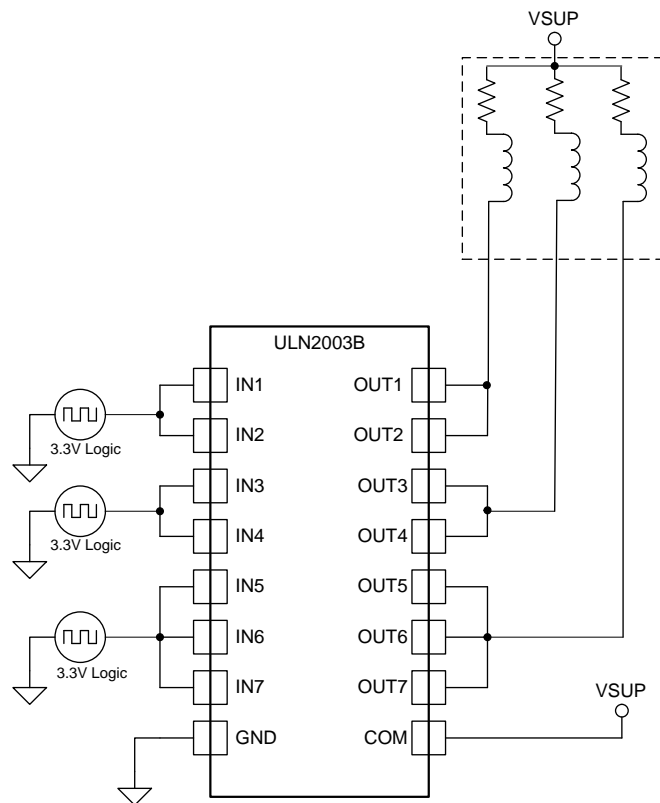

Copyright © 2016, Texas Instruments Incorporated

Figure 23. ULN2003B as Inductive Load Driver

Typical Application (continued)

9.2.1 Design Requirements

For this design example, use the parameters listed in [Table 1](#) as the input parameters.

Table 1. Design Parameters

| DESIGN PARAMETER ⁽¹⁾ | EXAMPLE VALUE |
|-------------------------------------|---|
| GPIO Voltage | 3.3 V or 5 V |
| Coil Supply Voltage | 12 V to 48 V |
| Number of Channels | 7 |
| Output Current (R _{COIL}) | 20 mA to 300 mA per channel (See Figure 5) |
| Duty Cycle | See Figure 6 to Figure 14 |

(1) These test conditions can not be run simultaneously.

9.2.2 Detailed Design Procedure

When using ULN2003B in a coil driving application, determine the following:

- Input Voltage Range
- Temperature Range
- Output and Drive Current
- Power Dissipation

9.2.2.1 Drive Current

The coil current is determined by the coil voltage (V_{SUP}), coil resistance and output low voltage (V_{OL} or V_{CE(SAT)}).

$$I_{\text{COIL}} = (V_{\text{SUP}} - V_{\text{CE(SAT)}}) / R_{\text{COIL}} \quad (1)$$

9.2.2.2 Output Low Voltage

The output low voltage (V_{OL}) is the same thing as V_{CE(SAT)} and can be determined by, [Figure 1](#), [Figure 2](#), or [Figure 4](#).

9.2.2.3 Power Dissipation and Temperature

The number of coils driven is dependent on the coil current and on-chip power dissipation. The number of coils driven can be determined by [Figure 6](#) or [Figure 7](#).

For a more accurate determination of number of coils possible, use [Equation 2](#) to calculate ULN2003B on-chip power dissipation P_D:

$$P_D = \sum_{i=1}^N V_{\text{OL}i} \times I_{\text{L}i}$$

where

- N is the number of channels active together.
- V_{OLi} is the OUT_i pin voltage for the load current I_{Li}. This is the same as V_{CE(SAT)} (2)

In order to guarantee reliability of ULN2003B and the system the on-chip power dissipation must be lower than or equal to the maximum allowable power dissipation (PD_(MAX)) dictated by [Equation 3](#).

$$PD_{\text{(MAX)}} = \frac{(T_{\text{J(MAX)}} - T_{\text{A}})}{\theta_{\text{JA}}}$$

where

- T_{J(MAX)} is the target maximum junction temperature.
- T_A is the operating ambient temperature.
- θ_{JA} is the package junction to ambient thermal resistance. (3)

TI recommends to limit ULN2003B IC's die junction temperature to less than 125°C. The IC junction temperature is directly proportional to the on-chip power dissipation.

9.2.3 Application Curves

The following curves were generated with ULN2003B driving an OMRON G5NB relay – $V_{in} = 5.0V$; $V_{sup} = 12 V$ and $R_{COIL} = 2.8 k\Omega$

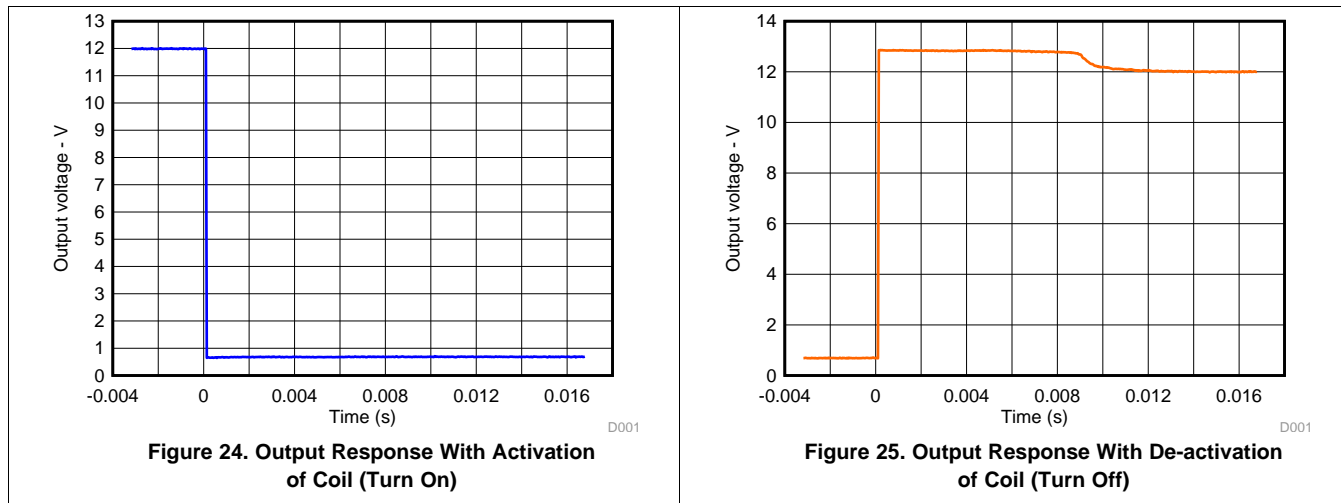

10 Power Supply Recommendations

This part does not need a power supply; however, the COM pin is typically tied to the system power supply. When this is the case, it is very important to make sure that the output voltage does not exceed the COM pin voltage. This will heavily forward bias the fly-back diodes and cause a large current to flow into COM, potentially damaging the on-chip metal or over-heating the part.

11 Layout

11.1 Layout Guidelines

Thin traces can be used on the input due to the low current logic that is typically used to drive UNL2003B. Care must be taken to separate the input channels as much as possible, as to eliminate cross-talk. Thick traces are recommended for the output, in order to drive whatever high currents that may be needed. Wire thickness can be determined by the trace material's current density and desired drive current.

Since all of the channels currents return to a common emitter, it is best to size that trace width to be very wide. Some applications require up to 2.5 A.

11.2 Layout Example

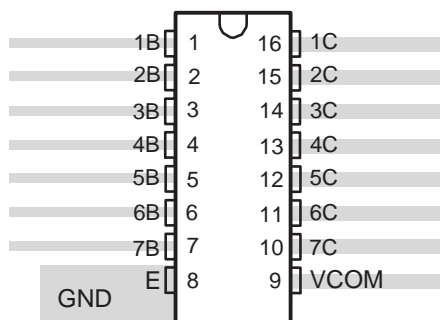

Figure 26. Package Layout

12 Device and Documentation Support

12.1 Receiving Notification of Documentation Updates

To receive notification of documentation updates, navigate to the device product folder on ti.com. In the upper right corner, click on *Alert me* to register and receive a weekly digest of any product information that has changed. For change details, review the revision history included in any revised document.

12.2 Community Resources

The following links connect to TI community resources. Linked contents are provided "AS IS" by the respective contributors. They do not constitute TI specifications and do not necessarily reflect TI's views; see TI's [Terms of Use](#).

TI E2E™ Online Community *TI's Engineer-to-Engineer (E2E) Community*. Created to foster collaboration among engineers. At e2e.ti.com, you can ask questions, share knowledge, explore ideas and help solve problems with fellow engineers.

Design Support *TI's Design Support* Quickly find helpful E2E forums along with design support tools and contact information for technical support.

12.3 Trademarks

E2E is a trademark of Texas Instruments.
All other trademarks are the property of their respective owners.

12.4 Electrostatic Discharge Caution



This integrated circuit can be damaged by ESD. Texas Instruments recommends that all integrated circuits be handled with appropriate precautions. Failure to observe proper handling and installation procedures can cause damage.

ESD damage can range from subtle performance degradation to complete device failure. Precision integrated circuits may be more susceptible to damage because very small parametric changes could cause the device not to meet its published specifications.

12.5 Glossary

[SLYZ022](#) — *TI Glossary*.

This glossary lists and explains terms, acronyms, and definitions.

13 Mechanical, Packaging, and Orderable Information

The following pages include mechanical, packaging, and orderable information. This information is the most current data available for the designated devices. This data is subject to change without notice and revision of this document. For browser-based versions of this data sheet, refer to the left-hand navigation.

PACKAGING INFORMATION

| Orderable Device | Status (1) | Package Type | Package Drawing | Pins | Package Qty | Eco Plan (2) | Lead/Ball Finish (6) | MSL Peak Temp (3) | Op Temp (°C) | Device Marking (4/5) | Samples |
|------------------|---------------|--------------|-----------------|------|-------------|-------------------------|-------------------------|----------------------|--------------|-------------------------|-------------------------|
| ULN2003BDR | ACTIVE | SOIC | D | 16 | 2500 | Green (RoHS & no Sb/Br) | CU NIPDAU CU SN | Level-1-260C-UNLIM | -40 to 105 | ULN2003B | Samples |
| ULN2003BN | ACTIVE | PDIP | N | 16 | 25 | Pb-Free (RoHS) | CU SN | N / A for Pkg Type | -40 to 105 | ULN2003BN | Samples |
| ULN2003BPWR | ACTIVE | TSSOP | PW | 16 | 2000 | Green (RoHS & no Sb/Br) | CU NIPDAU CU SN | Level-1-260C-UNLIM | -40 to 105 | UN2003B | Samples |

(1) The marketing status values are defined as follows:

ACTIVE: Product device recommended for new designs.

LIFEBUY: TI has announced that the device will be discontinued, and a lifetime-buy period is in effect.

NRND: Not recommended for new designs. Device is in production to support existing customers, but TI does not recommend using this part in a new design.

PREVIEW: Device has been announced but is not in production. Samples may or may not be available.

OBsolete: TI has discontinued the production of the device.

(2) Eco Plan - The planned eco-friendly classification: Pb-Free (RoHS), Pb-Free (RoHS Exempt), or Green (RoHS & no Sb/Br) - please check <http://www.ti.com/productcontent> for the latest availability information and additional product content details.

TBD: The Pb-Free/Green conversion plan has not been defined.

Pb-Free (RoHS): TI's terms "Lead-Free" or "Pb-Free" mean semiconductor products that are compatible with the current RoHS requirements for all 6 substances, including the requirement that lead not exceed 0.1% by weight in homogeneous materials. Where designed to be soldered at high temperatures, TI Pb-Free products are suitable for use in specified lead-free processes.

Pb-Free (RoHS Exempt): This component has a RoHS exemption for either 1) lead-based flip-chip solder bumps used between the die and package, or 2) lead-based die adhesive used between the die and leadframe. The component is otherwise considered Pb-Free (RoHS compatible) as defined above.

Green (RoHS & no Sb/Br): TI defines "Green" to mean Pb-Free (RoHS compatible), and free of Bromine (Br) and Antimony (Sb) based flame retardants (Br or Sb do not exceed 0.1% by weight in homogeneous material)

(3) MSL, Peak Temp. - The Moisture Sensitivity Level rating according to the JEDEC industry standard classifications, and peak solder temperature.

(4) There may be additional marking, which relates to the logo, the lot trace code information, or the environmental category on the device.

(5) Multiple Device Markings will be inside parentheses. Only one Device Marking contained in parentheses and separated by a "~" will appear on a device. If a line is indented then it is a continuation of the previous line and the two combined represent the entire Device Marking for that device.

(6) Lead/Ball Finish - Orderable Devices may have multiple material finish options. Finish options are separated by a vertical ruled line. Lead/Ball Finish values may wrap to two lines if the finish value exceeds the maximum column width.

Important Information and Disclaimer: The information provided on this page represents TI's knowledge and belief as of the date that it is provided. TI bases its knowledge and belief on information provided by third parties, and makes no representation or warranty as to the accuracy of such information. Efforts are underway to better integrate information from third parties. TI has taken and

continues to take reasonable steps to provide representative and accurate information but may not have conducted destructive testing or chemical analysis on incoming materials and chemicals. TI and TI suppliers consider certain information to be proprietary, and thus CAS numbers and other limited information may not be available for release.

In no event shall TI's liability arising out of such information exceed the total purchase price of the TI part(s) at issue in this document sold by TI to Customer on an annual basis.

TAPE AND REEL INFORMATION

QUADRANT ASSIGNMENTS FOR PIN 1 ORIENTATION IN TAPE

*All dimensions are nominal

| Device | Package Type | Package Drawing | Pins | SPQ | Reel Diameter (mm) | Reel Width W1 (mm) | A0 (mm) | B0 (mm) | K0 (mm) | P1 (mm) | W (mm) | Pin1 Quadrant |
|-------------|--------------|-----------------|------|------|--------------------|--------------------|---------|---------|---------|---------|--------|---------------|
| ULN2003BDR | SOIC | D | 16 | 2500 | 330.0 | 16.4 | 6.5 | 10.3 | 2.1 | 8.0 | 16.0 | Q1 |
| ULN2003BDR | SOIC | D | 16 | 2500 | 330.0 | 16.8 | 6.5 | 10.3 | 2.1 | 8.0 | 16.0 | Q1 |
| ULN2003BPWR | TSSOP | PW | 16 | 2000 | 330.0 | 12.4 | 6.9 | 5.6 | 1.6 | 8.0 | 12.0 | Q1 |
| ULN2003BPWR | TSSOP | PW | 16 | 2000 | 330.0 | 12.4 | 6.9 | 5.6 | 1.6 | 8.0 | 12.0 | Q1 |

TAPE AND REEL BOX DIMENSIONS

*All dimensions are nominal

| Device | Package Type | Package Drawing | Pins | SPQ | Length (mm) | Width (mm) | Height (mm) |
|-------------|--------------|-----------------|------|------|-------------|------------|-------------|
| ULN2003BDR | SOIC | D | 16 | 2500 | 367.0 | 367.0 | 38.0 |
| ULN2003BDR | SOIC | D | 16 | 2500 | 364.0 | 364.0 | 27.0 |
| ULN2003BPWR | TSSOP | PW | 16 | 2000 | 364.0 | 364.0 | 27.0 |
| ULN2003BPWR | TSSOP | PW | 16 | 2000 | 367.0 | 367.0 | 35.0 |

D (R-PDSO-G16)

PLASTIC SMALL OUTLINE



- NOTES:
- A. All linear dimensions are in inches (millimeters).
 - B. This drawing is subject to change without notice.
 - C. Body length does not include mold flash, protrusions, or gate burrs. Mold flash, protrusions, or gate burrs shall not exceed 0.006 (0,15) each side.
 - D. Body width does not include interlead flash. Interlead flash shall not exceed 0.017 (0,43) each side.
 - E. Reference JEDEC MS-012 variation AC.

D (R-PDSO-G16)

PLASTIC SMALL OUTLINE



- NOTES:
- A. All linear dimensions are in millimeters.
 - B. This drawing is subject to change without notice.
 - C. Publication IPC-7351 is recommended for alternate designs.
 - D. Laser cutting apertures with trapezoidal walls and also rounding corners will offer better paste release. Customers should contact their board assembly site for stencil design recommendations. Refer to IPC-7525 for other stencil recommendations.
 - E. Customers should contact their board fabrication site for solder mask tolerances between and around signal pads.



4220204/A 02/2017

NOTES:

1. All linear dimensions are in millimeters. Any dimensions in parenthesis are for reference only. Dimensioning and tolerancing per ASME Y14.5M.
2. This drawing is subject to change without notice.
3. This dimension does not include mold flash, protrusions, or gate burrs. Mold flash, protrusions, or gate burrs shall not exceed 0.15 mm per side.
4. This dimension does not include interlead flash. Interlead flash shall not exceed 0.25 mm per side.
5. Reference JEDEC registration MO-153.

EXAMPLE BOARD LAYOUT

PW0016A

TSSOP - 1.2 mm max height

SMALL OUTLINE PACKAGE



LAND PATTERN EXAMPLE
EXPOSED METAL SHOWN
SCALE: 10X



SOLDER MASK DETAILS

4220204/A 02/2017

NOTES: (continued)

- 6. Publication IPC-7351 may have alternate designs.
- 7. Solder mask tolerances between and around signal pads can vary based on board fabrication site.

EXAMPLE STENCIL DESIGN

PW0016A

TSSOP - 1.2 mm max height

SMALL OUTLINE PACKAGE



SOLDER PASTE EXAMPLE
BASED ON 0.125 mm THICK STENCIL
SCALE: 10X

4220204/A 02/2017

NOTES: (continued)

8. Laser cutting apertures with trapezoidal walls and rounded corners may offer better paste release. IPC-7525 may have alternate design recommendations.
9. Board assembly site may have different recommendations for stencil design.

N (R-PDIP-T**)

PLASTIC DUAL-IN-LINE PACKAGE

16 PINS SHOWN



- NOTES:
- A. All linear dimensions are in inches (millimeters).
 - B. This drawing is subject to change without notice.
 - Falls within JEDEC MS-001, except 18 and 20 pin minimum body length (Dim A).
 - The 20 pin end lead shoulder width is a vendor option, either half or full width.

IMPORTANT NOTICE AND DISCLAIMER

TI PROVIDES TECHNICAL AND RELIABILITY DATA (INCLUDING DATASHEETS), DESIGN RESOURCES (INCLUDING REFERENCE DESIGNS), APPLICATION OR OTHER DESIGN ADVICE, WEB TOOLS, SAFETY INFORMATION, AND OTHER RESOURCES "AS IS" AND WITH ALL FAULTS, AND DISCLAIMS ALL WARRANTIES, EXPRESS AND IMPLIED, INCLUDING WITHOUT LIMITATION ANY IMPLIED WARRANTIES OF MERCHANTABILITY, FITNESS FOR A PARTICULAR PURPOSE OR NON-INFRINGEMENT OF THIRD PARTY INTELLECTUAL PROPERTY RIGHTS.

These resources are intended for skilled developers designing with TI products. You are solely responsible for (1) selecting the appropriate TI products for your application, (2) designing, validating and testing your application, and (3) ensuring your application meets applicable standards, and any other safety, security, or other requirements. These resources are subject to change without notice. TI grants you permission to use these resources only for development of an application that uses the TI products described in the resource. Other reproduction and display of these resources is prohibited. No license is granted to any other TI intellectual property right or to any third party intellectual property right. TI disclaims responsibility for, and you will fully indemnify TI and its representatives against, any claims, damages, costs, losses, and liabilities arising out of your use of these resources.

TI's products are provided subject to TI's Terms of Sale (www.ti.com/legal/termsofsale.html) or other applicable terms available either on ti.com or provided in conjunction with such TI products. TI's provision of these resources does not expand or otherwise alter TI's applicable warranties or warranty disclaimers for TI products.

Mailing Address: Texas Instruments, Post Office Box 655303, Dallas, Texas 75265
Copyright © 2019, Texas Instruments Incorporated