

NOTE:
 1. LEAD Co-planarity :Max 0.10mm;
 2. No rust, contamination, damage nor deformation effecting on function
 3 Switch moving area
 4 Non-cumulative tolerance
 5. Circuit Drawing of switch

7	SLIDER	1	LCP UL94V-0
6	LINK	1	STAINLESS STEEL
5	SPRING	1	SWP-B
4	CAM Plate(inside)	1	STAINLESS STEEL
3	CONTACT	1	COPPER ALLOY Nickel Barrier Contact: Au 1u" Min over Ni 40~200u" Lead : Au flash 1u" Min over Ni 40~200u"
2	COVER	1	STAINLESS STEEL Not hold down : Nickel 10~200u" Hold down : Au flash 1u" Min over Ni 10~200u"
1	HOUSING	1	LCP UL94V-0
NO.	DESCRIPTION	Q'TY	Material

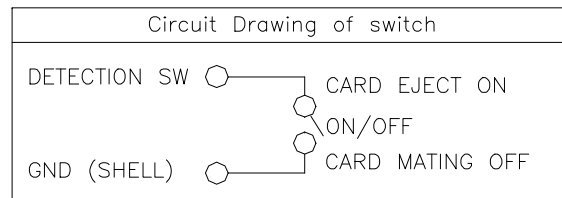

MANUFACTURE DWG		东莞市讯普电子科技有限公司 DongGuan XunPu Electronics Co.,Ltd	
UNLESS OTHERWISE SPECIFIED TOLERANCES		TITLE:1.27mm Push Micro Sim CARD CONN CUSTOMER DRAWING . PAR SMC-214-ARP7 DWN CHKD APVD	
DECIMALS:	ANGLES:		SCALE1:1
X.X:±0.30	X'.:±2'		UNIT:MM
X.XX:±0.20	X.X':±1'		SIZE:A4
X.XXX:±0.10			SHEET:1F1
CUSTOMER COPY			REV:A

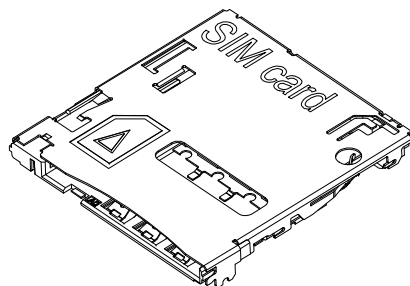
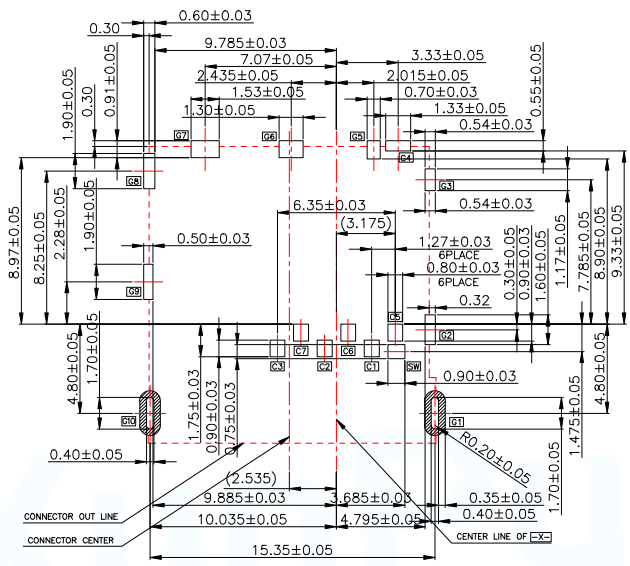
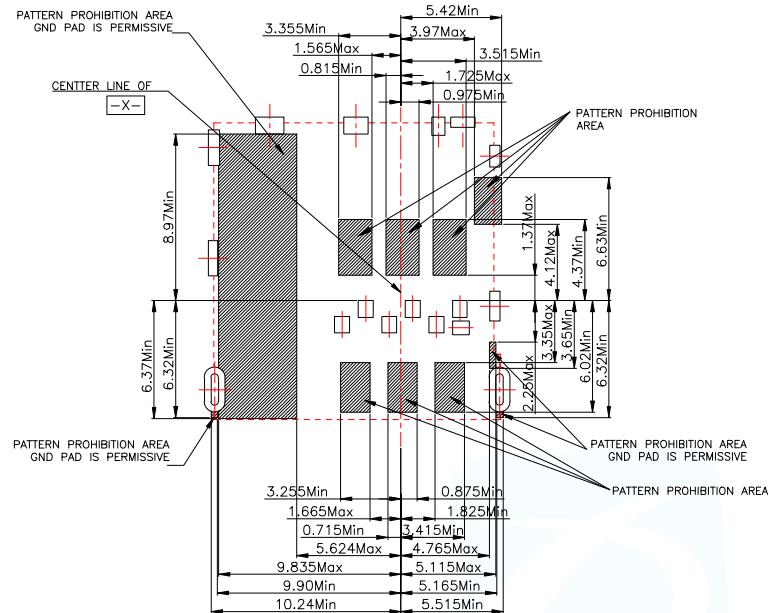

【 SIM Card Pin Assignments 】

PIN	Name
C1	Vcc
C2	RST
C3	CLK
C4	Reserved
C5	GND
C6	Vpp
C7	I/O
C8	Reserved

【 Connector Pin Assignments 】

No.	Pin name	Description
①	C1	Vcc of SIM
②	C2	RST of SIM
③	C3	CLK of SIM
④	C5	GND of SIM
⑤	C6	Vpp of SIM
⑥	C7	I/O of SIM
⑦	SW	Detection Switch
⑧~⑰	GND	Shell Ground

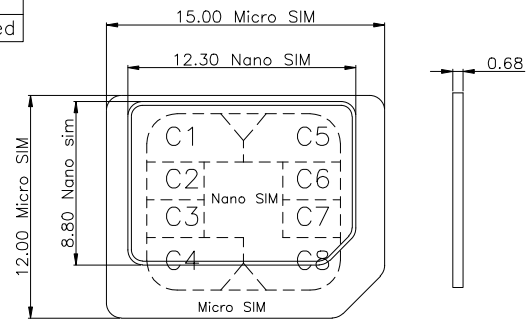
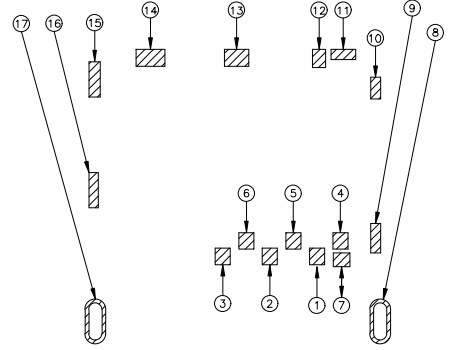

MANUFACTURE DWG			东莞市讯普电子科技有限公司 DongGuan XunPu Electronics Co.,Ltd		
UNLESS OTHERWISE SPECIFIED TOLERANCES			TITLE:1.27mm Push Micro Sim CARD CONN CUSTOMER DRAWING .		
DECIMALS:	ANGLES:	PAR	SMC-214-ARP7		
X.X:±0.30	X'.:±2'	DWN			
X.XX:±0.20	X.X':±1'	CHKD			
X.XXX:±0.10		APVD			
CUSTOMER COPY		SCALE1:1	UNIT:MM		
		SIZE:A4	SHEET:1F1	REV:A	

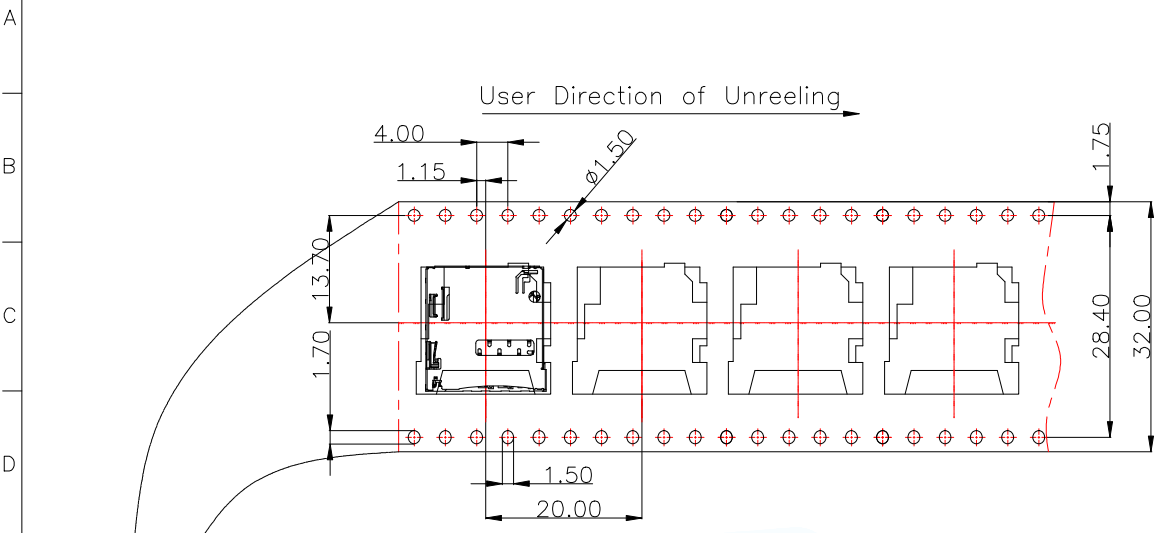

NOTES

1. NUMBER OF CONNECTORS:1000PCS/REEL
2. LEAD TAPE LENGTH

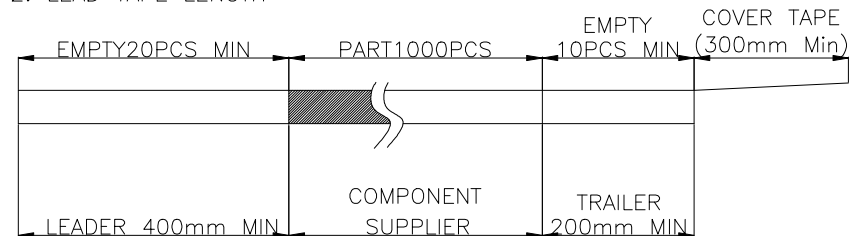

3. QUANTITY:7000PCS/CARTON
4. WEIGHT:
THE NET WEIGHT OF PER PART IS 0.38g.

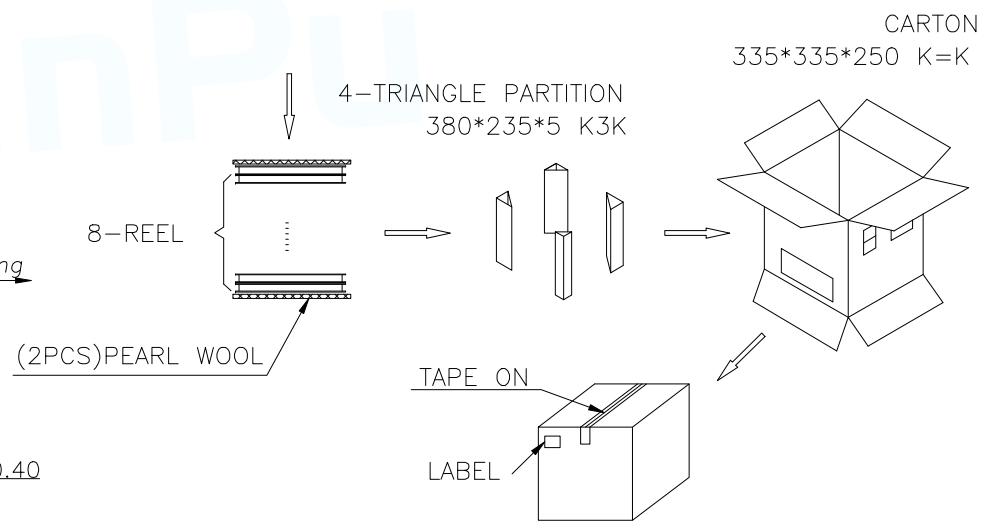
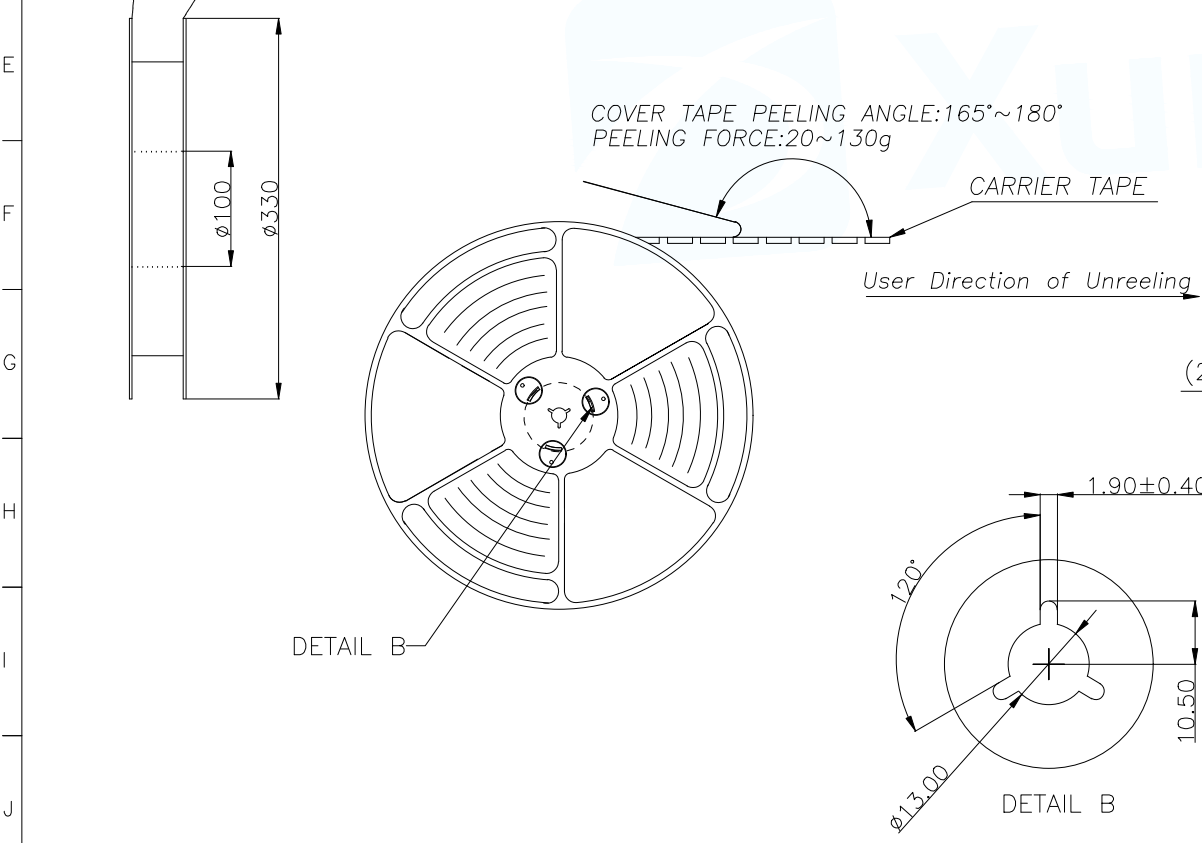

MANUFACTURE DWG			 东莞市讯普电子科技有限公司 DongGuan XunPu Electronics Co.,Ltd	
UNLESS OTHERWISE SPECIFIED TOLERANCES			TITLE:1.27mm Push Micro Sim CARD CONN CUSTOMER DRAWING .	
DECIMALS:	ANGLES:	PAR	SMC-214-ARP7	
X.X:±0.30	X'.:±2'	DWN		
X.XX:±0.20	X.X':±1'	CHKD		
X.XXX:±0.10		APVD		
CUSTOMER COPY		SCALE1:1	UNIT:MM	⊕ ◀
		SIZE:A4	SHEET:1F1	REV:A