

National Semiconductor is now part of
Texas Instruments.

Search <http://www.ti.com/> for the latest technical
information and details on our current products and services.

LM119QML

High Speed Dual Comparator

General Description

The LM119 is a precision high speed dual comparator fabricated on a single monolithic chip. It is designed to operate over a wide range of supply voltages down to a single 5V logic supply and ground. Further, it has higher gain and lower input currents than devices like the LM710. The uncommitted collector of the output stage makes the LM119 compatible with RTL, DTL and TTL as well as capable of driving lamps and relays at currents up to 25 mA.

Although designed primarily for applications requiring operation from digital logic supplies, the LM119 is fully specified for power supplies up to $\pm 15V$. It features faster response than the LM111 at the expense of higher power dissipation. However, the high speed, wide operating voltage range and low package count make the LM119 much more versatile than older devices like the LM711.

Features

- Available with radiation guaranteed
— High Dose Rate 100 krad(Si)
- Two independent comparators
- Operates from a single 5V supply
- Typically 80 ns response time at $\pm 15V$
- Minimum fan-out of 2 each side
- Maximum input current of 1 μA over temperature
- Inputs and outputs can be isolated from system ground
- High common mode slew rate

Ordering Information

NS Part Number	SMD Part Number	NS Package Number	Package Description
LM119E/883		E20A	20LD LCC
LM119E-SMD	86014012A	E20A	20LD LCC
LM119H/883		H10C	10LD T0-100 Metal Can
LM119H-SMD	86014011A	H10C	10LD T0-100 Metal Can
LM119H-QMLV	5962-9679801VIA	H10C	10LD T0-100 Metal Can
LM119HRQMLV High Dose Rate	5962R9679801VIA 100k rd(Si)	H10C	10LD T0-100 Metal Can
LM119J/883		J14A	14LD CERDIP
LM119J-SMD	8601401CA	J14A	14LD CERDIP
LM119J-QMLV	5962-9679801VCA	J14A	14LD CERDIP
LM119JRQMLV High Dose Rate	5962R9679801VCA 100k rd(Si)	J14A	14LD CERDIP
LM119W/883		W10A	10LD CERPAK
LM119W-SMD	8601401HA	W10A	10LD CERPAK
LM119W-QMLV	5962-9679801VHA	W10A	10LD CERPAK
LM119WRQMLV High Dose Rate	5962R9679801VHA 100k rd(Si)	W10A	10LD CERPAK
LM119WG/883		WG10A	10LD Ceramic SOIC
LM119WG-QMLV	5962-9679801VXA	WG10A	10LD Ceramic SOIC
LM119WGRQMLV High Dose Rate	5962R9679801VXA 100k rd(Si)	WG10A	10LD Ceramic SOIC

Connection Diagrams

Dual-In-Line Package

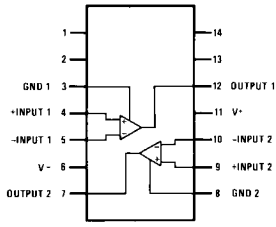

20143704

Top View
See NS Package Number J14A

Leadless Chip Carrier

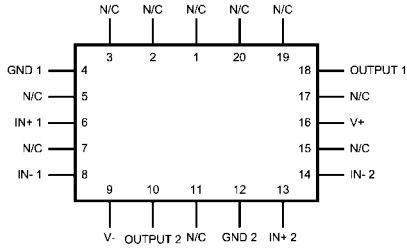

20143708

Top View
See NS Package Number E20A

Metal Can Package

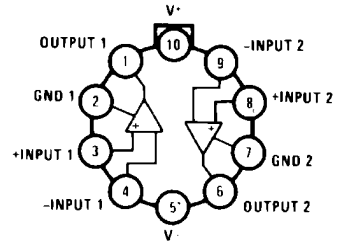

20143707

Case is connected to pin 5 (V-)

Top View
See NS Package Number H10C

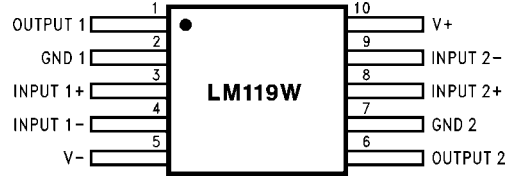

20143709

See NS Package Number W10A, WG10A

Schematic Diagram

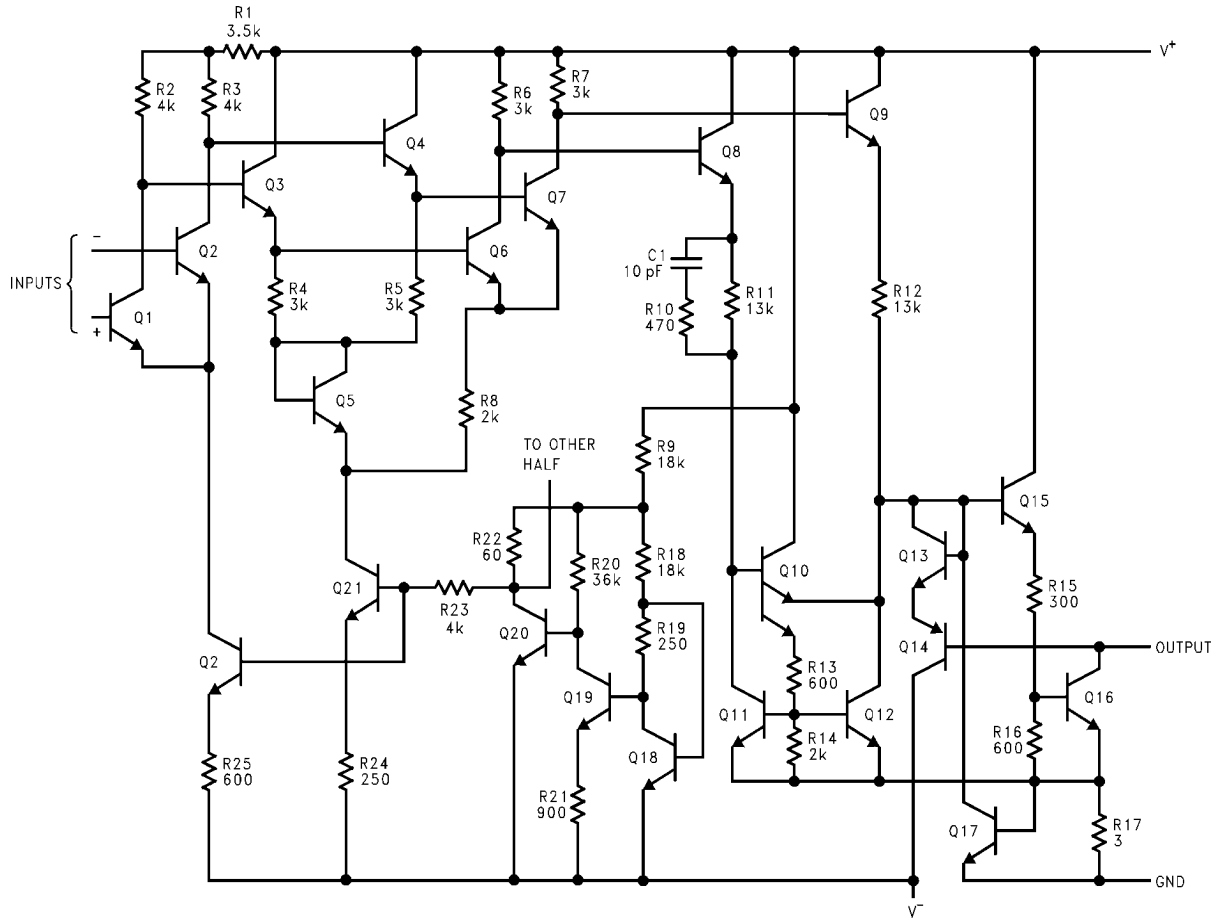

20143701

*Do not operate the LM119 with more than 16V between GND and V+

Absolute Maximum Ratings (Note 1)

Total Supply Voltage	36V
Output to Negative Supply Voltage	36V
Ground to Negative Supply Voltage	25V
Ground to Positive Supply Voltage	18V
Differential Input Voltage	±5V
Input Voltage (Note 3)	±15V
Power Dissipation (Note 2)	500 mW
Output Short Circuit Duration	10 sec
Storage Temperature Range	-65°C ≤ T _A ≤ 150°C
Operating Ambient Temperature Range	-55°C ≤ T _A ≤ 125°C
Maximum Junction Temperature (T _J)	150°C
Lead Temperature (Soldering, 10 sec.)	260°C
Thermal Resistance	
θ_{JA}	
E Package (Still Air)	89°C/W
E Package (500LF/Min Air flow)	63°C/W
H Package (Still Air)	162°C/W
H Package (500LF/Min Air flow)	88°C/W
J Package (Still Air)	94°C/W
J Package (500LF/Min Air flow)	52°C/W
W Package (Still Air)	215°C/W
W Package (500LF/Min Air flow)	132°C/W
WG Package (Still Air)	215°C/W
WG Package (500LF/Min Air flow)	132°C/W
θ_{JC}	
E Package	5°C/W
H Package	31°C/W
J Package	11°C/W
W Package	13°C/W
WG Package	13°C/W
Package Weight	
E Package	TBD
H Package	TBD
J Package	TBD
W Package	TBD
WG Package	225mg
ESD rating (Note 4)	800V

Quality Conformance Inspection

Mil-Std-883, Method 5005 - Group A

Subgroup	Description	Temp °C
1	Static tests at	25
2	Static tests at	125
3	Static tests at	-55
4	Dynamic tests at	25
5	Dynamic tests at	125
6	Dynamic tests at	-55
7	Functional tests at	25
8A	Functional tests at	125
8B	Functional tests at	-55
9	Switching tests at	25
10	Switching tests at	125
11	Switching tests at	-55
12	Settling time at	25
13	Settling time at	125
14	Settling time at	-55

LM119/883 Electrical Characteristics

DC Parameters

The following conditions apply, unless otherwise specified. $V_{CM} = 0V$

Symbol	Parameter	Conditions	Notes	Min	Max	Units	Sub-groups
$+I_{CC}$	Positive Supply Current	$\pm V_{CC} = \pm 15V, V_O = \text{Low}$ $V^+ = 5.6V \text{ thru } 1.4K\Omega$			11	mA	1
					11.5	mA	2
$-I_{CC}$	Negative Supply Current	$\pm V_{CC} = \pm 15V, V_O = \text{Low}$ $V^+ = 5.6V \text{ thru } 1.4K\Omega$		-4.2		mA	1
				-4.5		mA	2
I_{Leak}	Output Leakage Current	$+V_{CC} = 15V, -V_{CC} = -1V,$ $V_{Gnd} = 0V, V_O = 35V,$ $V_I = 5mV$			1.8	μA	1
					9.5	μA	2
					10.0	μA	3
I_{IB}	Input Bias Current	$\pm V_{CC} = \pm 15V$			0.475	μA	1
					0.95	μA	2, 3
		$+V_{CC} = 5V, -V_{CC} = 0V,$ $V_{CM} = 1.5V$			0.475	μA	1
					.95	μA	2, 3
V_{IO}	Input Offset Voltage	$+V_{CC} = 5V, -V_{CC} = 0V,$ $V_{CM} = 1V, R_S \leq 5K\Omega$		-3.8	3.8	mV	1
				-6.8	6.8	mV	2, 3
		$+V_{CC} = 5V, -V_{CC} = 0V,$ $V_{CM} = 3V, R_S \leq 5K\Omega$		-3.8	3.8	mV	1
				-6.8	6.8	mV	2, 3
		$\pm V_{CC} = \pm 15V, V_{CM} = 12V,$ $R_S \leq 5K\Omega$		-3.8	3.8	mV	1
				-6.8	6.8	mV	2, 3
I_{IO}	Input Offset Current	$+V_{CC} = 5V, -V_{CC} = 0V, V_{CM} = 1V$		-75	75	nA	1
				-100	100	nA	2, 3
		$+V_{CC} = 5V, -V_{CC} = 0V, V_{CM} = 3V$		-75	75	nA	1
				-100	100	nA	2, 3
		$\pm V_{CC} = \pm 15V, V_{CM} = 12V$		-75	75	nA	1
				-100	100	nA	2, 3
V_{Sat}	Output Saturation Voltage	$\pm V_{CC} = \pm 15V, I_O = 25mA,$ $V_I = -5mV$			1.5	V	1
		$+V_{CC} = 5V, -V_{CC} = 0V,$ $I_O = 4.0mA$	(Note 11)		0.4	V	1, 2
			(Note 11)		0.6	V	3
A_V	Voltage Gain	$\pm V_{CC} = \pm 15V, \Delta V_O = 12V,$ $R_L = 1.4K\Omega$	(Note 8), (Note 9)	10.5		K	4
			(Note 8), (Note 9)	10		K	5, 6
		$+V_{CC} = 5V, -V_{CC} = 0V,$ $\Delta V_O = 4.5V, R_L = 1.4K\Omega$	(Note 8), (Note 10)	8.0		K	4
			(Note 8), (Note 10)	5.0		K	5
			(Note 8), (Note 10)	5.8		K	6
			(Note 8), (Note 10)				

LM119-SMD Electrical Characteristics SMD 8601401

DC Parameters

The following conditions apply, unless otherwise specified. $V_{CM} = 0V$

Symbol	Parameter	Conditions	Notes	Min	Max	Units	Sub-groups	
$+I_{CC}$	Positive Supply Current	$\pm V_{CC} = \pm 15V$, $V_O = \text{Low}$ $V^+ = 5.6V$ thru $1.4K\Omega$			11	mA	1	
					11.5	mA	2, 3	
$-I_{CC}$	Negative Supply Current	$\pm V_{CC} = \pm 15V$, $V_O = \text{Low}$ $V^+ = 5.6V$ thru $1.4K\Omega$			-4.2	mA	1	
					-4.5	mA	2	
					-6.0	mA	3	
I_{Leak}	Output Leakage Current	$+V_{CC} = 15V$, $-V_{CC} = -1V$, $V_{Gnd} = 0V$, $V_O = 35V$	(Note 5)		1.8	μA	1	
			(Note 5)		10	μA	2, 3	
I_{IB}	Input Bias Current	$\pm V_{CC} = \pm 15V$			0.475	μA	1	
					0.95	μA	2, 3	
		$+V_{CC} = 5V$		(Note 6)		0.475	μA	1
				(Note 6)		.95	μA	2, 3
V_{IO}	Input Offset Voltage	$+V_{CC} = 5V$, $V_{CM} = 1V$, $R_S \leq 5K\Omega$	(Note 6)	-3.8	3.8	mV	1	
			(Note 6)	-6.8	6.8	mV	2, 3	
		$+V_{CC} = 5V$, $V_{CM} = 3V$, $R_S \leq 5K\Omega$	(Note 6)	-3.8	3.8	mV	1	
			(Note 6)	-6.8	6.8	mV	2, 3	
		$\pm V_{CC} = \pm 15V$, $V_{CM} = 12V$, $R_S \leq 5K\Omega$		-3.8	3.8	mV	1	
				-6.8	6.8	mV	2, 3	
		$\pm V_{CC} = \pm 15V$, $V_{CM} = -12V$, $R_S \leq 5K\Omega$		-3.8	3.8	mV	1	
				-6.8	6.8	mV	2, 3	
I_{IO}	Input Offset Current	$+V_{CC} = 5V$, $V_{CM} = 1V$	(Note 6)	-75	75	nA	1	
			(Note 6)	-100	100	nA	2, 3	
		$+V_{CC} = 5V$, $V_{CM} = 3V$	(Note 6)	-75	75	nA	1	
			(Note 6)	-100	100	nA	2, 3	
		$\pm V_{CC} = \pm 15V$, $V_{CM} = 12V$		-75	75	nA	1	
				-100	100	nA	2, 3	
		$\pm V_{CC} = \pm 15V$, $V_{CM} = -12V$		-75	75	nA	1	
				-100	100	nA	2, 3	
V_I	Input Voltage Range	$+V_{CC} = 5V$	(Note 6), (Note 7)	1.0	3.0	V	1, 2, 3	
		$\pm V_{CC} = \pm 15V$	(Note 7)	-12	12	V	1, 2, 3	
V_{Sat}	Output Saturation Voltage	$\pm V_{CC} = \pm 15V$, $I_O = 25mA$, $V_I \leq -5mV$	(Note 5)		1.5	V	1, 2, 3	
					0.4	V	1, 2	
		$+V_{CC} = 3.5V$, $-V_{CC} = -1V$, $V_I \leq -6mV$, $I_O \leq 3.2mA$		0.6	V	3		
A_V	Voltage Gain	$\pm V_{CC} = \pm 15V$, $\Delta V_O = 12V$, $R_L = 1.4K\Omega$	(Note 8)	10.5		K	4	
			(Note 8)	10		K	5, 6	
		$+V_{CC} = 5V$, $-V_{CC} = 0V$, $\Delta V_O = 4.5V$, $R_L = 1.4K\Omega$	(Note 6), (Note 8)	8.0		K	4	
			(Note 6), (Note 8)	5.0		K	5	
			(Note 6), (Note 8)	5.8		K	6	
CMRR	Common Mode Rejection Ratio	$\pm V_{CC} = \pm 15V$, $V_{CM} = \pm 12V$		80		dB	4	

LM119 Electrical Characteristics SMD 5962-9679801

DC Parameters

The following conditions apply, unless otherwise specified. $V_{CM} = 0V$

Symbol	Parameter	Conditions	Notes	Min	Max	Units	Sub-groups
$+I_{CC}$	Positive Supply Current	$\pm V_{CC} = \pm 15V$, $V_O = \text{Low}$ $V^+ = 5.6V$ thru $1.4K\Omega$			11	mA	1
					11.5	mA	2, 3
$-I_{CC}$	Negative Supply Current	$\pm V_{CC} = \pm 15V$, $V_O = \text{Low}$ $V^+ = 5.6V$ thru $1.4K\Omega$			-4.2	mA	1
					-4.5	mA	2
					-6.0	mA	3
I_{Leak}	Output Leakage Current	$+V_{CC} = 15V$, $-V_{CC} = -1V$, $V_{Gnd} = 0V$, $V_O = 35V$	(Note 5)		1.8	μA	1
			(Note 5)		10	μA	2, 3
I_{IB}	Input Bias Current	$\pm V_{CC} = \pm 15V$			0.475	μA	1
					0.95	μA	2, 3
		$+V_{CC} = 5V$	(Note 6)		0.475	μA	1
			(Note 6)		.95	μA	2, 3
V_{IO}	Input Offset Voltage	$+V_{CC} = 5V$, $V_{CM} = 1V$, $R_S \leq 5K\Omega$	(Note 6)	-3.8	3.8	mV	1
			(Note 6)	-6.8	6.8	mV	2, 3
		$+V_{CC} = 5V$, $V_{CM} = 3V$, $R_S \leq 5K\Omega$	(Note 6)	-3.8	3.8	mV	1
			(Note 6)	-6.8	6.8	mV	2, 3
		$\pm V_{CC} = \pm 15V$, $V_{CM} = 12V$, $R_S \leq 5K\Omega$		-3.8	3.8	mV	1
				-6.8	6.8	mV	2, 3
		$\pm V_{CC} = \pm 15V$, $V_{CM} = -12V$, $R_S \leq 5K\Omega$		-3.8	3.8	mV	1
				-6.8	6.8	mV	2, 3
I_{IO}	Input Offset Current	$+V_{CC} = 5V$, $V_{CM} = 1V$	(Note 6)	-75	75	nA	1
			(Note 6)	-100	100	nA	2, 3
		$+V_{CC} = 5V$, $V_{CM} = 3V$	(Note 6)	-75	75	nA	1
			(Note 6)	-100	100	nA	2, 3
		$\pm V_{CC} = \pm 15V$, $V_{CM} = 12V$		-75	75	nA	1
				-100	100	nA	2, 3
		$\pm V_{CC} = \pm 15V$, $V_{CM} = -12V$		-75	75	nA	1
				-100	100	nA	2, 3
V_I	Input Voltage Range	$+V_{CC} = 5V$	(Note 6), (Note 7)	1.0	3.0	V	1, 2, 3
		$\pm V_{CC} = \pm 15V$	(Note 7)	-12	12	V	1, 2, 3
V_{Sat}	Output Saturation Voltage	$\pm V_{CC} = \pm 15V$, $I_O = 25mA$, $V_I \leq -5mV$	(Note 5)		1.5	V	1, 2, 3
		$+V_{CC} = 3.5V$, $-V_{CC} = -1V$, $V_I \leq -6mV$, $I_O \leq 3.2mA$			0.4	V	1, 2
					0.6	V	3
A_V	Voltage Gain	$\pm V_{CC} = \pm 15V$, $\Delta V_O = 12V$, $R_L = 1.4K\Omega$	(Note 8)	10.5		K	4
			(Note 8)	10		K	5, 6
		$+V_{CC} = 5V$, $-V_{CC} = 0V$, $\Delta V_O = 4.5V$, $R_L = 1.4K\Omega$	(Note 6), (Note 8)	8.0		K	4
			(Note 6), (Note 8)	5.0		K	5
			(Note 6), (Note 8)	5.8		K	6
CMRR	Common Mode Rejection Ratio	$\pm V_{CC} = \pm 15V$, $V_{CM} = \pm 12V$		80		dB	4

DC DELTA Parameters SMD 5962-9679801

The following conditions apply, unless otherwise specified.

$V_{CM} = 0V$, Delta calculations performed on QMLV devices at group B, subgroup 5 only.

Symbol	Parameter	Conditions	Notes	Min	Max	Units	Sub-groups
$+I_{CC}$	Positive Supply Current	$\pm V_{CC} = \pm 15V$, $V_O = \text{Low}$ $V^+ = 5.6V$ thru $1.4K\Omega$		-1.0	1.0	mA	1
$-I_{CC}$	Negative Supply Current	$\pm V_{CC} = \pm 15V$, $V_O = \text{Low}$ $V^+ = 5.6V$ thru $1.4K\Omega$		-0.5	0.5	mA	1
V_{IO}	Input Offset Voltage	$+V_{CC} = 5V$, $V_{CM} = 1V$, $R_S \leq 5K\Omega$		-0.4	0.4	mV	1

Post Radiation Parameters SMD 5962-9679801 (Note 12)

The following conditions apply, unless otherwise specified.

$V_{CM} = 0V$

Symbol	Parameter	Conditions	Notes	Min	Max	Units	Sub-groups
I_{IB}	input Bias Current	$\pm V_{CC} = \pm 15V$			1.0	μA	1
		$V_{CC} = 5V$			1.0	μA	1
V_{IO}	Input Offset Voltage	$+V_{CC} = 5V$, $V_{CM} = 1V$, $R_S \leq 5K\Omega$		-4.0	4.0	mV	1
		$+V_{CC} = 5V$, $V_{CM} = 3V$, $R_S \leq 5K\Omega$		-4.0	4.0	mV	1
		$\pm V_{CC} = \pm 15V$, $V_{CM} = 12V$, $R_S \leq 5K\Omega$		-4.0	4.0	mV	1
		$\pm V_{CC} = \pm 15V$, $V_{CM} = -12V$, $R_S \leq 5K\Omega$		-4.0	4.0	mV	1

Note 1: Absolute Maximum Ratings indicate limits beyond which damage to the device may occur. Operating Ratings indicate conditions for which the device is functional, but do not guarantee specific performance limits. For guaranteed specifications and test conditions, see the Electrical Characteristics. The guaranteed specifications apply only for the test conditions listed. Some performance characteristics may degrade when the device is not operated under the listed test conditions.

Note 2: The maximum power dissipation must be derated at elevated temperatures and is dictated by T_{Jmax} (maximum junction temperature), θ_{JA} (package junction to ambient thermal resistance), and T_A (ambient temperature). The maximum allowable power dissipation at any temperature is $P_{Dmax} = (T_{Jmax} - T_A) / \theta_{JA}$ or the number given in the Absolute Maximum Ratings, whichever is lower.

Note 3: For supply voltages less than $\pm 15V$ the absolute maximum input voltage is equal to the supply voltage.

Note 4: Human Body model, $1.5K\Omega$ in series with $100pF$.

Note 5: $V_I \geq 8mV$ at extremes for I_{Leak} and $V_I \leq -8mV$ at extremes for V_{Sat} (V_I to exceed V_{OS}).

Note 6: $5V$ differential across $+V_{CC}$ and $-V_{CC}$.

Note 7: Parameter guaranteed by V_{IO} and I_{IO} tests.

Note 8: $K = V/mV$.

Note 9: Gain is computed with an output swing from $+13.5V$ to $+1.5V$.

Note 10: Gain is computed with an output swing from $+5.0V$ to $+0.5V$.

Note 11: Output is monitored by measuring V_I with limits from 0 to $6mV$ at all temperatures

Note 12: Pre and post irradiation limits are identical to those listed under AC and DC electrical characteristics except as listed in the Post Radiation Limits Table. These parts may be dose rate sensitive in a space environment and demonstrate enhanced low dose rate effect. Radiation end point limits for the noted parameters are guaranteed only for the conditions as specified in Mil-Std-883, Method 1019, Condition A.

Typical Performance Characteristics

Input Currents

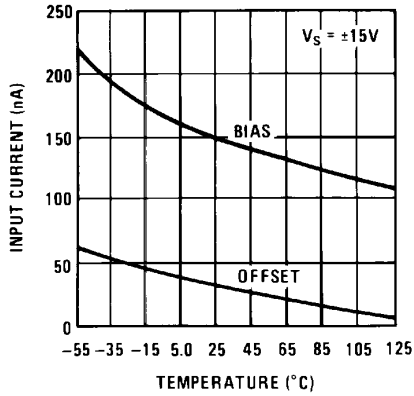

20143710

Common Mode Limits

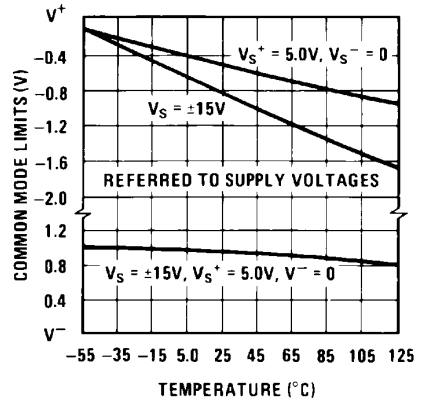

20143711

Transfer Function

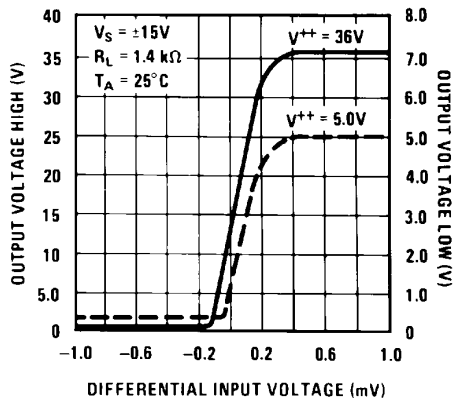

20143712

Response Time for Various Input Overdrives

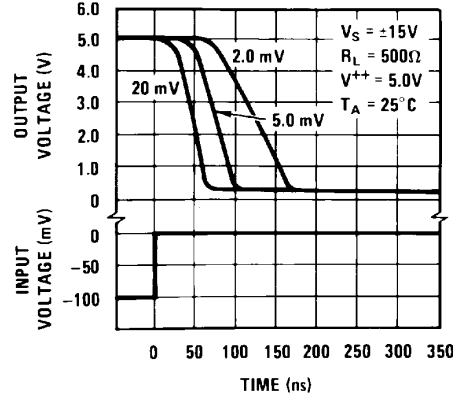

20143713

Response Time for Various Input Overdrives

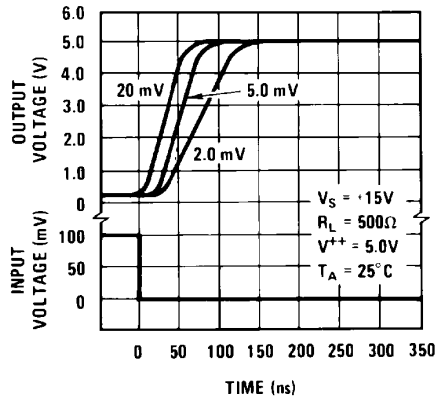

20143714

Input Characteristics

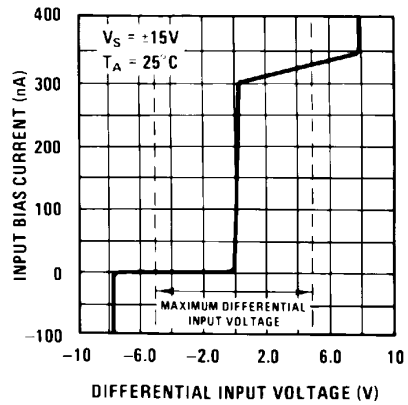

20143715

Response Time for Various Input Overdrives

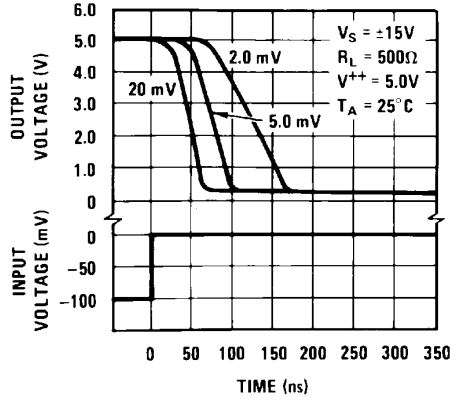

20143716

Response Time for Various Input Overdrives

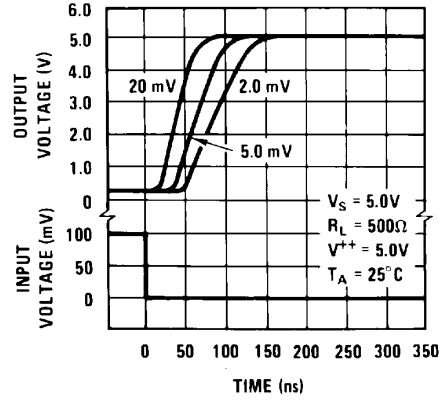

20143717

Output Saturation Voltage

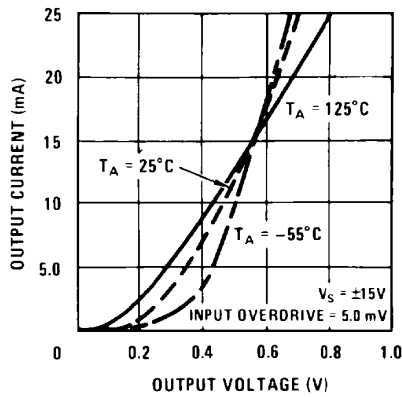

20143718

Supply Current

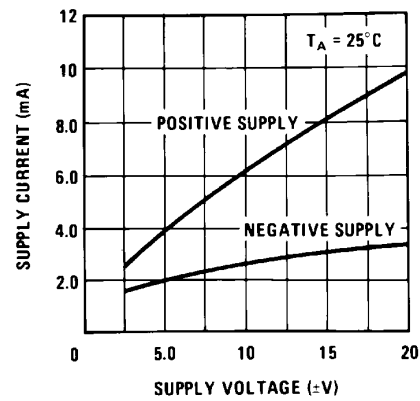

20143719

Supply Current

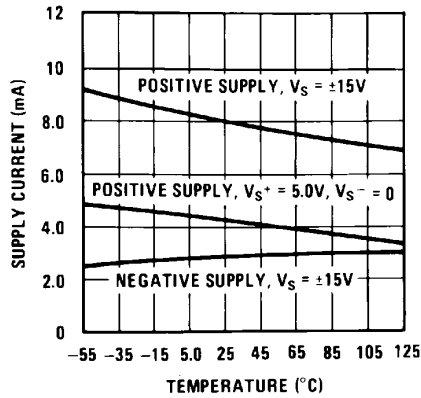

20143720

Output Limiting Characteristics

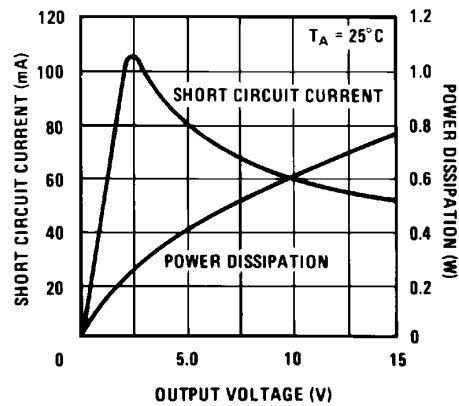

20143721

Typical Applications (Note Pin numbers are for metal can package.)

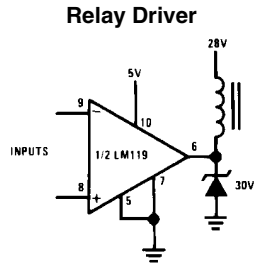

20143705

Note 13: Pin numbers are for metal can package.

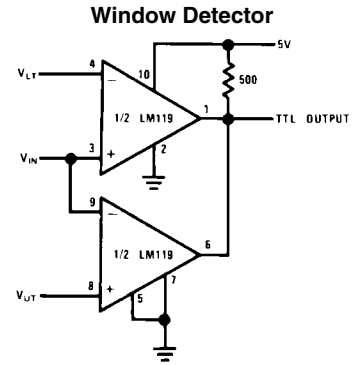

20143706

$$V_{OUT} = 5V \text{ for } V_{LT} \leq V_{IN} \leq V_{UT}$$

$$V_{OUT} = 0 \text{ for } V_{IN} \leq V_{LT} \text{ or } V_{IN} \geq V_{UT}$$

Revision History

Date Released	Revision	Section	Originator	Changes
07/24/08	A	New release to corporate format	L. Lytle	2 MDS datasheets converted into one corporate data sheet format. Added Radiation information. MDS data sheets MNL119-X Rev. 0F1 & MDLM119-X Rev 2A2 will be archived.

Physical Dimensions inches (millimeters) unless otherwise noted

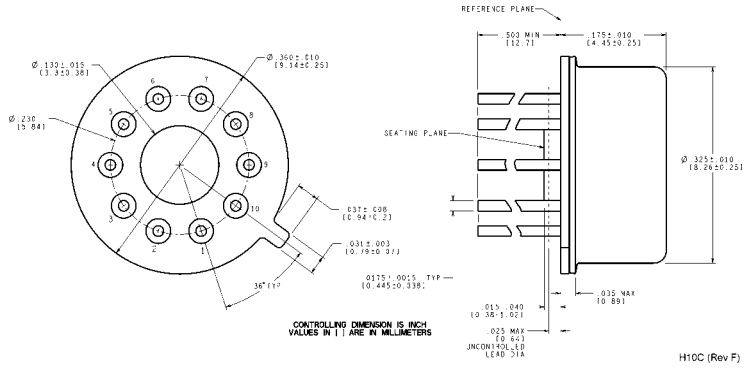

Metal Can Package (H)
NS Package Number H10C

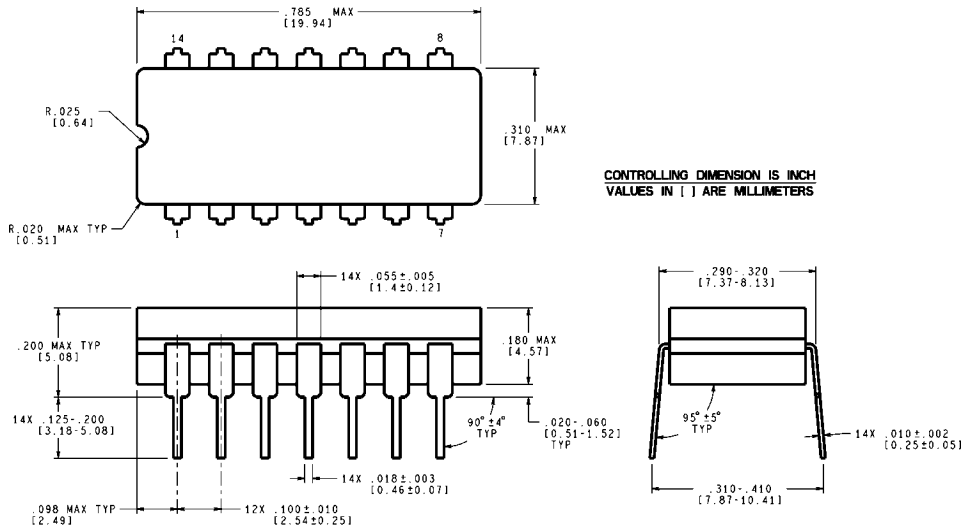

Cavity Dual-In-Line Package (J)
NS Package Number J14A

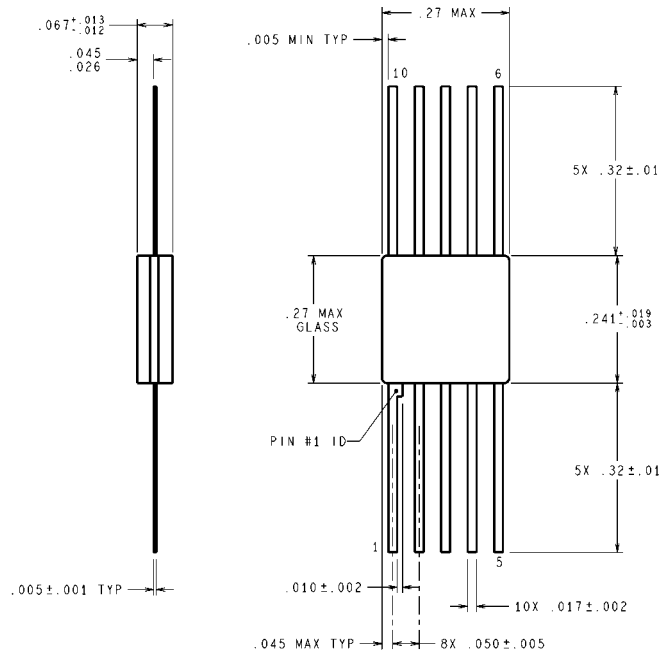

DIMENSIONS ARE IN INCHES

**Ceramic Flatpack (W)
NS Package Number W10A**

W10A (Rev H)

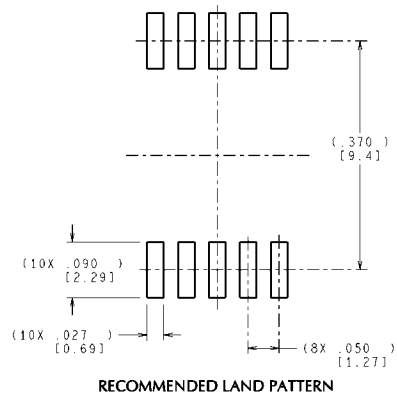
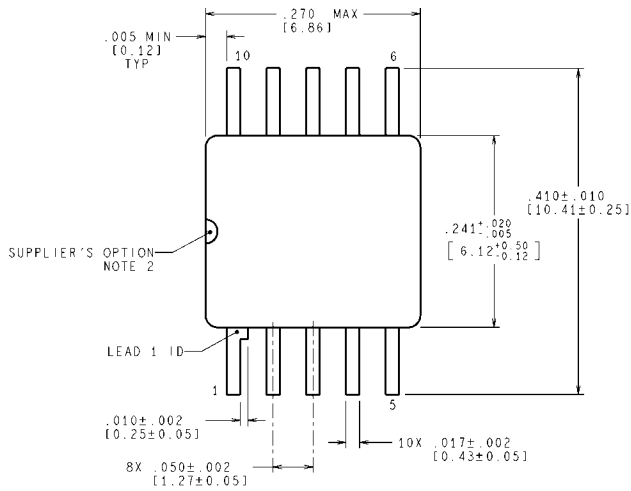

MIL-PRF-38535
CONFIGURATION CONTROL

CONTROLLING DIMENSION IS INCH
VALUES IN [] ARE MILLIMETERS
DIMENSIONS IN () FOR REFERENCE ONLY

**Ceramic SOIC (WG)
NS Package Number WG10A**

WG10A (Rev E)

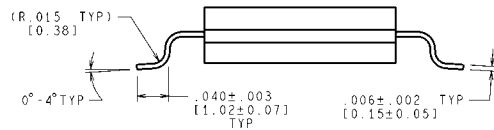

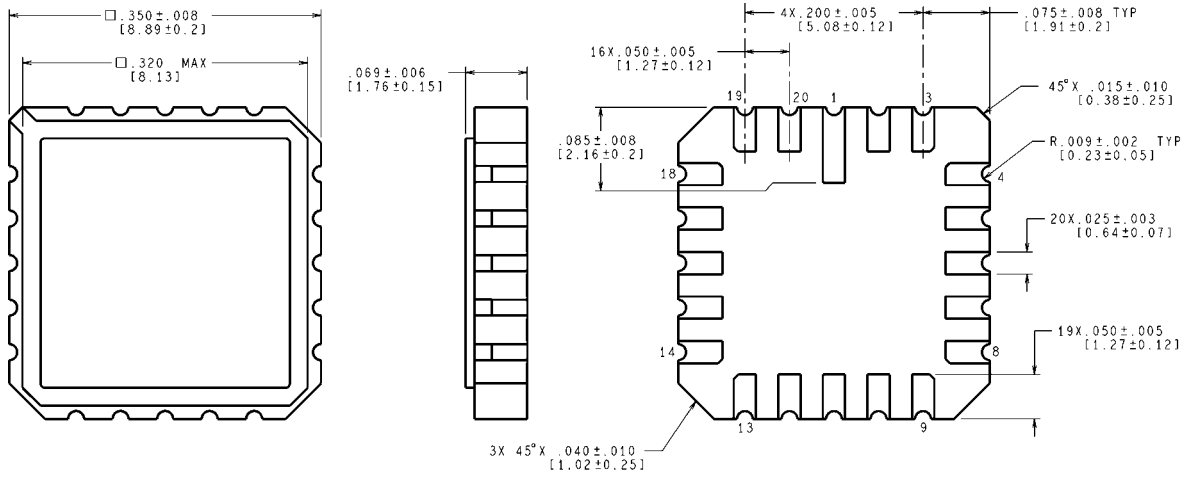

CONTROLLING DIMENSION IS INCH
VALUES IN [] ARE MILLIMETERS

Metal Leadless Chip Carrier (LCC)
NS Package Number E20A

E20A (Rev F)

Notes

LM119QML

Notes

For more National Semiconductor product information and proven design tools, visit the following Web sites at:

Products		Design Support	
Amplifiers	www.national.com/amplifiers	WEBENCH	www.national.com/webench
Audio	www.national.com/audio	Analog University	www.national.com/AU
Clock Conditioners	www.national.com/timing	App Notes	www.national.com/appnotes
Data Converters	www.national.com/adc	Distributors	www.national.com/contacts
Displays	www.national.com/displays	Green Compliance	www.national.com/quality/green
Ethernet	www.national.com/ethernet	Packaging	www.national.com/packaging
Interface	www.national.com/interface	Quality and Reliability	www.national.com/quality
LVDS	www.national.com/lvds	Reference Designs	www.national.com/refdesigns
Power Management	www.national.com/power	Feedback	www.national.com/feedback
Switching Regulators	www.national.com/switchers		
LDOs	www.national.com/ldo		
LED Lighting	www.national.com/led		
PowerWise	www.national.com/powerwise		
Serial Digital Interface (SDI)	www.national.com/sdi		
Temperature Sensors	www.national.com/tempsensors		
Wireless (PLL/VCO)	www.national.com/wireless		

THE CONTENTS OF THIS DOCUMENT ARE PROVIDED IN CONNECTION WITH NATIONAL SEMICONDUCTOR CORPORATION ("NATIONAL") PRODUCTS. NATIONAL MAKES NO REPRESENTATIONS OR WARRANTIES WITH RESPECT TO THE ACCURACY OR COMPLETENESS OF THE CONTENTS OF THIS PUBLICATION AND RESERVES THE RIGHT TO MAKE CHANGES TO SPECIFICATIONS AND PRODUCT DESCRIPTIONS AT ANY TIME WITHOUT NOTICE. NO LICENSE, WHETHER EXPRESS, IMPLIED, ARISING BY ESTOPPEL OR OTHERWISE, TO ANY INTELLECTUAL PROPERTY RIGHTS IS GRANTED BY THIS DOCUMENT.

TESTING AND OTHER QUALITY CONTROLS ARE USED TO THE EXTENT NATIONAL DEEMS NECESSARY TO SUPPORT NATIONAL'S PRODUCT WARRANTY. EXCEPT WHERE MANDATED BY GOVERNMENT REQUIREMENTS, TESTING OF ALL PARAMETERS OF EACH PRODUCT IS NOT NECESSARILY PERFORMED. NATIONAL ASSUMES NO LIABILITY FOR APPLICATIONS ASSISTANCE OR BUYER PRODUCT DESIGN. BUYERS ARE RESPONSIBLE FOR THEIR PRODUCTS AND APPLICATIONS USING NATIONAL COMPONENTS. PRIOR TO USING OR DISTRIBUTING ANY PRODUCTS THAT INCLUDE NATIONAL COMPONENTS, BUYERS SHOULD PROVIDE ADEQUATE DESIGN, TESTING AND OPERATING SAFEGUARDS.

EXCEPT AS PROVIDED IN NATIONAL'S TERMS AND CONDITIONS OF SALE FOR SUCH PRODUCTS, NATIONAL ASSUMES NO LIABILITY WHATSOEVER, AND NATIONAL DISCLAIMS ANY EXPRESS OR IMPLIED WARRANTY RELATING TO THE SALE AND/OR USE OF NATIONAL PRODUCTS INCLUDING LIABILITY OR WARRANTIES RELATING TO FITNESS FOR A PARTICULAR PURPOSE, MERCHANTABILITY, OR INFRINGEMENT OF ANY PATENT, COPYRIGHT OR OTHER INTELLECTUAL PROPERTY RIGHT.

LIFE SUPPORT POLICY

NATIONAL'S PRODUCTS ARE NOT AUTHORIZED FOR USE AS CRITICAL COMPONENTS IN LIFE SUPPORT DEVICES OR SYSTEMS WITHOUT THE EXPRESS PRIOR WRITTEN APPROVAL OF THE CHIEF EXECUTIVE OFFICER AND GENERAL COUNSEL OF NATIONAL SEMICONDUCTOR CORPORATION. As used herein:

Life support devices or systems are devices which (a) are intended for surgical implant into the body, or (b) support or sustain life and whose failure to perform when properly used in accordance with instructions for use provided in the labeling can be reasonably expected to result in a significant injury to the user. A critical component is any component in a life support device or system whose failure to perform can be reasonably expected to cause the failure of the life support device or system or to affect its safety or effectiveness.

National Semiconductor and the National Semiconductor logo are registered trademarks of National Semiconductor Corporation. All other brand or product names may be trademarks or registered trademarks of their respective holders.

Copyright© 2008 National Semiconductor Corporation

For the most current product information visit us at www.national.com



National Semiconductor Americas Technical Support Center
Email: support@nsc.com
Tel: 1-800-272-9959

National Semiconductor Europe Technical Support Center
Email: europe.support@nsc.com
German Tel: +49 (0) 180 5010 771
English Tel: +44 (0) 870 850 4288

National Semiconductor Asia Pacific Technical Support Center
Email: ap.support@nsc.com

National Semiconductor Japan Technical Support Center
Email: jpn.feedback@nsc.com