

**300-mA Output, High PSRR,  
Low-Dropout Linear Regulator****Features**

- Input Voltage Range: 1.5 V to 5.5 V
- Output Voltage Range:
  - Fixed Output Voltage: 0.75 V to 3.6 V
  - Adjustable Output Voltage: 0.75 V to 5 V
- $\pm 1\%$  Typical Output Accuracy Under Room Temperature
- 300 mA Maximum Output Current
- Low Dropout Voltage: 250 mV Typically at 300 mA
- High PSRR:
  - 70 dB at 1 kHz
  - 54 dB at 1 MHz
- Good Transient Response
- Stable with a 4.7  $\mu\text{F}$  or Larger Ceramic Output Capacitor
- Inrush Current Control During Startup
- Thermal Shutdown and Over-Current Protection
- Temperature Range:  $-40^{\circ}\text{C}$  to  $+125^{\circ}\text{C}$
- Package Options:
  - SOT23-5
  - 1 $\times$ 1 DFN-4

**Applications**

- Portable and Battery-Powered Equipment
- Mobile Phones and Tablets
- Digital Cameras and Audio Devices Power Supply
- Video Surveillance
- Wireless and IoT modules

**Description**

The TPL5031 series products are 300-mA high PSRR, low noise, and low dropout linear regulators with high output accuracy. The TPL5031 series products support both fixed output voltage ranges from 0.75 V to 3.6 V and adjustable output voltage ranges from 0.75 V to 5 V with an external resistor divider. The TPL5031 series products are stable with a 4.7  $\mu\text{F}$  or larger ceramic output capacitor.

The TPL5031 series products have high PSRR with 70 dB at 1 kHz. This feature makes TPL5031 series products very suitable for power-ripple-sensitive applications with high noise from the previous stage power supply, such as high-performance analog devices, or high-definition imaging equipment. Output shortage protection and thermal overload protection circuits improve the reliability under heavy load conditions.

The TPL5031 series products provide SOT23-5 and 1 $\times$ 1 DFN-4 packages with a guaranteed operating junction temperature range from  $-40^{\circ}\text{C}$  to  $+125^{\circ}\text{C}$ .

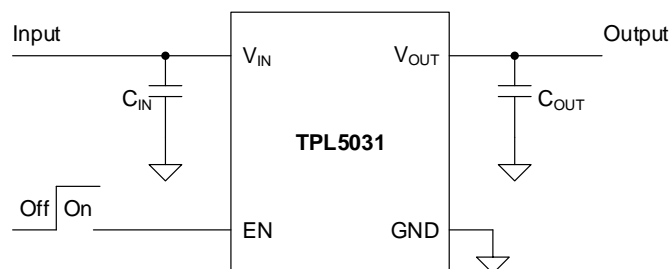
**Typical Application Schematic**

**Product Family Table**

Order Number	Output Voltage (V)	Package
TPL5031075-S5TR	0.75 V	SOT23-5
TPL503108-S5TR	0.8 V	SOT23-5
TPL503109-S5TR	0.9 V	SOT23-5
TPL5031092-S5TR	0.92 V	SOT23-5
TPL503110-S5TR	1.0 V	SOT23-5
TPL503111-S5TR	1.1 V	SOT23-5
TPL503112-S5TR	1.2 V	SOT23-5
TPL503115-S5TR	1.5 V	SOT23-5
TPL503118-S5TR	1.8 V	SOT23-5
TPL503121-S5TR	2.1 V	SOT23-5
TPL503125-S5TR	2.5 V	SOT23-5
TPL503127-S5TR	2.7 V	SOT23-5
TPL503128-S5TR	2.8 V	SOT23-5
TPL503129-S5TR	2.9 V	SOT23-5
TPL503130-S5TR	3.0 V	SOT23-5
TPL503133-S5TR	3.3 V	SOT23-5
TPL503136-S5TR	3.6 V	SOT23-5
TPL5031075-DF1R	0.75 V	1×1 DFN-4
TPL503108-DF1R	0.8 V	1×1 DFN-4
TPL503109-DF1R	0.9 V	1×1 DFN-4
TPL5031092-DF1R	0.92 V	1×1 DFN-4
TPL503110-DF1R	1.0 V	1×1 DFN-4
TPL503111-DF1R	1.1 V	1×1 DFN-4
TPL503112-DF1R	1.2 V	1×1 DFN-4
TPL503115-DF1R	1.5 V	1×1 DFN-4
TPL503118-DF1R	1.8 V	1×1 DFN-4
TPL503121-DF1R	2.1 V	1×1 DFN-4
TPL503125-DF1R	2.5 V	1×1 DFN-4
TPL503127-DF1R	2.7 V	1×1 DFN-4
TPL503128-DF1R	2.8 V	1×1 DFN-4
TPL503129-DF1R	2.9 V	1×1 DFN-4
TPL503130-DF1R	3.0 V	1×1 DFN-4
TPL503133-DF1R	3.3 V	1×1 DFN-4
TPL503136-DF1R	3.6 V	1×1 DFN-4

## Table of Contents

<b>Features</b> .....	<b>1</b>
<b>Applications</b> .....	<b>1</b>
<b>Description</b> .....	<b>1</b>
<b>Typical Application Schematic</b> .....	<b>1</b>
<b>Product Family Table</b> .....	<b>2</b>
<b>Revision History</b> .....	<b>4</b>
<b>Pin Configuration and Functions</b> .....	<b>5</b>
Pin Functions.....	5
<b>Specifications</b> .....	<b>6</b>
Absolute Maximum Ratings.....	6
ESD, Electrostatic Discharge Protection .....	6
Recommended Operating Conditions .....	6
Thermal Information .....	6
Electrical Characteristics .....	7
Typical Performance Characteristics.....	8
<b>Detailed Description</b> .....	<b>10</b>
Overview.....	10
Functional Block Diagram .....	10
Feature Description .....	10
<b>Application and Implementation</b> .....	<b>12</b>
Application Information.....	12
Typical Application .....	12
<b>Layout</b> .....	<b>13</b>
Layout Guideline.....	13
<b>Tape and Reel Information</b> .....	<b>14</b>
<b>Package Outline Dimensions</b> .....	<b>15</b>
SOT23-5.....	15
1x1 DFN-4 .....	16
<b>Order Information</b> .....	<b>17</b>
<b>IMPORTANT NOTICE AND DISCLAIMER</b> .....	<b>19</b>

## Revision History

Date	Revision	Notes
2020/08/31	Rev.Pre	Preliminary Version
2021/06/23	Rev.A.0	Initial Released
2022/02/15	Rev.A.1	1. Updated output voltage option and output voltage accuracy 2. Added note of $V_{DO}$

### Pin Configuration and Functions

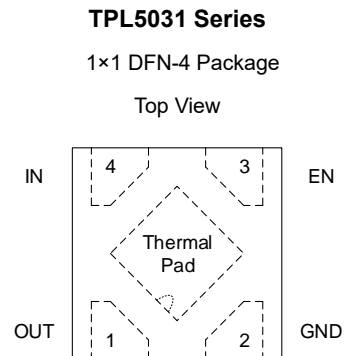
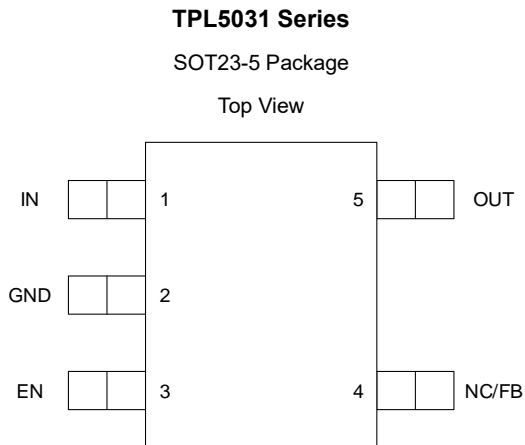

### Pin Functions

Name	Pin		I/O	Description
	SOT23-5	1x1 DFN-4		
EN	3	3	I	Enable pin. Drive EN high to turn on the regulator; drive EN low to turn off the regulator. For automatic startup, connect EN to IN directly.
FB	4	–	I	Output feedback pin (Adjustable version only). Connect to a resistor divider to adjust the output voltage.
GND	2	2	–	Ground reference pin. Connect GND pin to PCB ground plane directly.
IN	1	4	I	Input voltage pin. Bypass IN to GND with a 1 $\mu$ F or greater capacitor.
NC	4	–	–	No connection.
OUT	5	1	O	Regulated output voltage pin. Bypass OUT to GND with a 4.7 $\mu$ F or greater capacitor.

## Specifications

### Absolute Maximum Ratings

Parameter		Min	Max	Unit
IN, EN		-0.3	6	V
OUT		-0.3	6	V
FB		-0.3	6	V
T <sub>J</sub>	Junction Temperature Range	-40	150	°C
T <sub>STG</sub>	Storage Temperature Range	-65	150	°C
T <sub>L</sub>	Lead Temperature (Soldering 10 sec)		260	°C

(1) Stresses beyond those listed under Absolute Maximum Ratings may cause permanent damage to the device.

(2) All voltage values are with respect to GND.

### ESD, Electrostatic Discharge Protection

Symbol	Parameter	Condition	Minimum Level	Unit
HBM	Human Body Model ESD	ANSI/ESDA/JEDEC JS-001 <sup>(1)</sup>	±4	kV
CDM	Charged Device Model ESD	ANSI/ESDA/JEDEC JS-002 <sup>(2)</sup>	±1	kV

(1) JEDEC document JEP155 states that 500-V HBM allows safe manufacturing with a standard ESD control process.

(2) JEDEC document JEP157 states that 250-V CDM allows safe manufacturing with a standard ESD control process.

### Recommended Operating Conditions

Parameter		Min	Max	Unit
IN		1.5	5.5	V
EN		0	5.5	V
OUT		0	5	V
I <sub>OUT</sub>		0	300	mA
C <sub>OUT</sub>		4.7		μF
T <sub>J</sub>	Operating Junction Temperature Range	-40	125	°C
P <sub>D</sub>	Power Dissipation at Room Temperature	0	300	mW

### Thermal Information

Package Type	θ <sub>JA</sub>	θ <sub>Jc</sub>	Unit
SOT23-5	280	62	°C/W
DFN1x1-4	210	110	°C/W

**300-mA Output, High PSRR,  
Low-Dropout Linear Regulator**
**Electrical Characteristics**

All test conditions:  $V_{IN} = V_{OUT(NOM)} + 0.5\text{ V}$  or  $2.4\text{ V}$ , whichever is greater;  $C_{OUT} = 4.7\text{ }\mu\text{F}$ ,  $I_{OUT} = 1\text{ mA}$ ,  $T_A = +25^\circ\text{C}$ , unless otherwise noted.

Symbol	Parameter	Conditions	Min	Typ	Max	Unit
<b>Supply Voltage and Current</b>						
$V_{IN}$	Input supply voltage range		1.5		5.5	V
$I_{GND}$	Ground pin current	$I_{OUT} = 0\text{ mA}$		55		$\mu\text{A}$
$I_{SHDN}$	Shutdown current	$V_{EN} \leq 0.4\text{ V}$		0.02		$\mu\text{A}$
<b>Enable Input Voltage and Current</b>						
$V_{IH(EN)}$	EN logic-input high level (enable)		1.1		$V_{IN}$	V
$V_{IL(EN)}$	EN logic-input low level (disable)		0		0.4	V
$I_{EN}$	EN pin leakage current	$V_{EN} = 0\text{ V}$ or $5.5\text{ V}$		1		$\mu\text{A}$
<b>Regulated Output Voltage and Current</b>						
$V_{OUT}$	Output voltage accuracy	$V_{OUT} \leq 2.0\text{ V}$	-40		+40	mV
		$V_{OUT} > 2.0\text{ V}$	-2%		2%	
$\Delta V_{OUT}$	Line regulation	$V_{OUT(NOM)} + 0.5\text{ V} \leq V_{IN} \leq 5.5\text{ V}$ , $V_{IN} \geq 1.5\text{ V}$ , $I_{OUT} = 1\text{ mA}$		1		mV
	Load regulation	$I_{OUT} = 1\text{ mA}$ to $300\text{ mA}$		20		mV
$V_{DO}^{(1)}$	Dropout voltage	$V_{OUT} = 0.8\text{ V}$ , $I_{OUT} = 300\text{ mA}$		1200		mV
		$V_{OUT} = 1.2\text{ V}$ , $I_{OUT} = 300\text{ mA}$		800		mV
		$V_{OUT} = 1.8\text{ V}$ , $I_{OUT} = 300\text{ mA}$		460		mV
		$V_{OUT} = 2.8\text{ V}$ , $I_{OUT} = 300\text{ mA}$		340		mV
		$V_{OUT} = 3.3\text{ V}$ , $I_{OUT} = 300\text{ mA}$		250		mV
$I_{OUT}$	Output current	$V_{OUT}$ in regulation	0		300	mA
$I_{CL}$	Output current limit	$V_{OUT} = 0.9 \times V_{OUT(NOM)}$	350	500		mA
$I_{SC}$	Short-circuit current limit	$R_{LOAD} \leq 20\text{ m}\Omega$		300		mA
$R_{DIS}$	Active output discharge resistance	$V_{EN} \leq 0.4\text{ V}$		110		$\Omega$
PSRR	Power supply rejection ratio	$I_{OUT} = 10\text{ mA}$ , $f = 1\text{ kHz}$		70		dB
		$I_{OUT} = 10\text{ mA}$ , $f = 1\text{ MHz}$		54		dB
$V_N$	Output noise voltage	$I_{OUT} = 100\text{ mA}$ , BW = 100 Hz to 100 kHz		178		$\mu\text{V}_{RMS}$
$t_{STR}$	Start-up time	$I_{OUT} = 300\text{ mA}$		170		$\mu\text{s}$
<b>Temperature Range</b>						
$T_{SD}$	Thermal shutdown temperature			150		$^\circ\text{C}$
	Thermal shutdown hysteresis			20		$^\circ\text{C}$

(1) Dropout voltage is the minimum input to output voltage differential needed to maintain regulation at a specified output current. In dropout mode, the output voltage will be equal to  $V_{IN} - V_{DO}$ .

300-mA Output, High PSRR, Low-Dropout Linear Regulator

Typical Performance Characteristics

All test conditions:  $V_{IN} = V_{OUT(NOM)} + 1\text{ V}$ ,  $V_{OUT} = 3.3\text{ V}$ ,  $I_{OUT} = 1\text{ mA}$ ,  $C_{OUT} = 4.7\text{ }\mu\text{F}$ , unless otherwise noted.

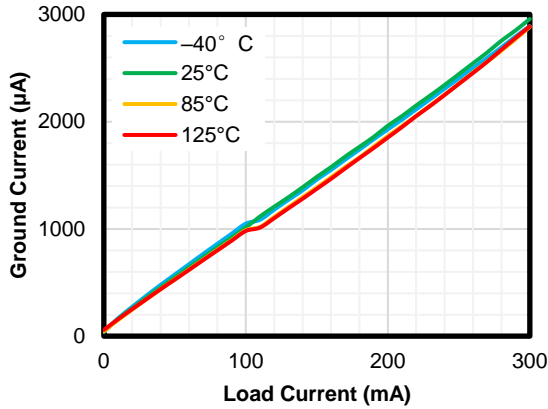

Figure 1. Quiescent Current vs Output Current

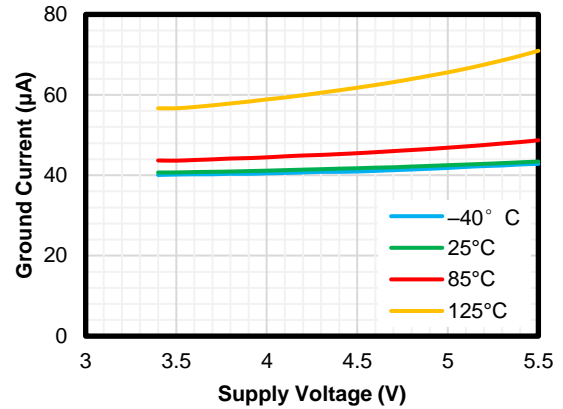

Figure 2. Quiescent Current vs Input Voltage

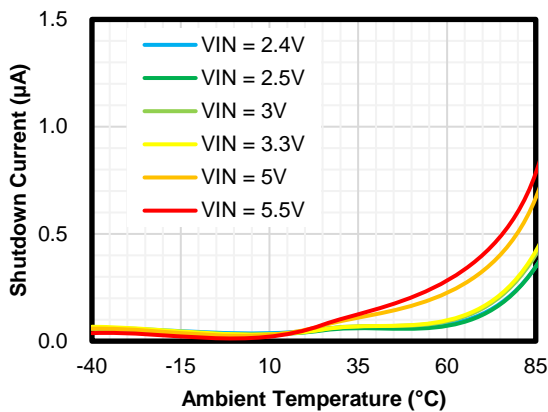

Figure 3. Shutdown Current vs Ambient Temperature

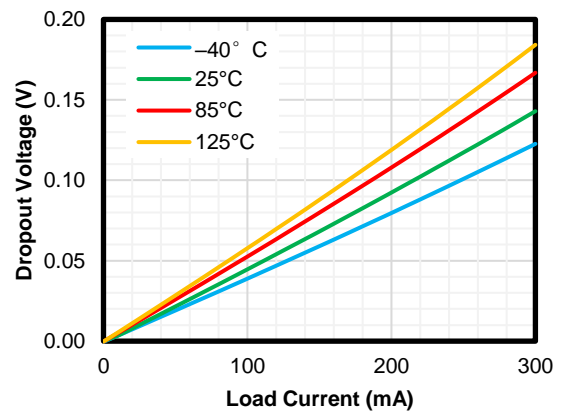

Figure 4. Dropout Voltage vs Output Current

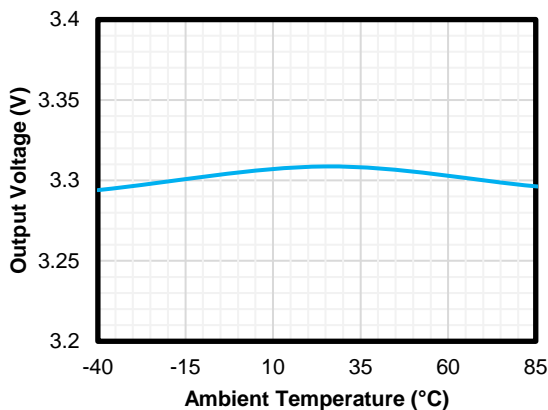

Figure 5. Output Voltage vs Ambient Temperature

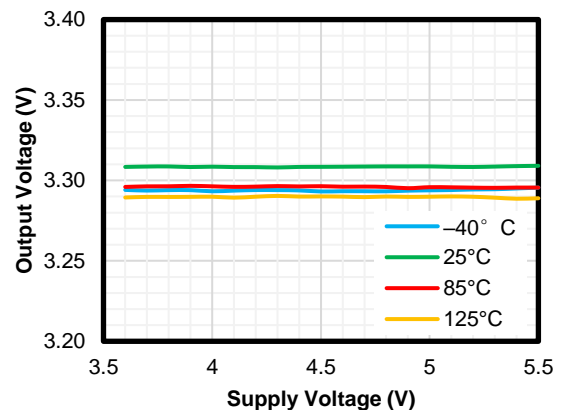

Figure 6. Line Regulation



300-mA Output, High PSRR, Low-Dropout Linear Regulator

Typical Performance Characteristics (Continued)

All test conditions:  $V_{IN} = V_{OUT(NOM)} + 1\text{ V}$ ,  $V_{OUT} = 3.3\text{ V}$ ,  $I_{OUT} = 1\text{ mA}$ ,  $C_{OUT} = 4.7\text{ }\mu\text{F}$ , unless otherwise noted.

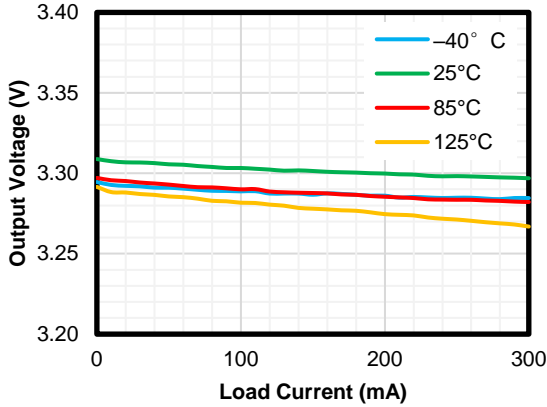
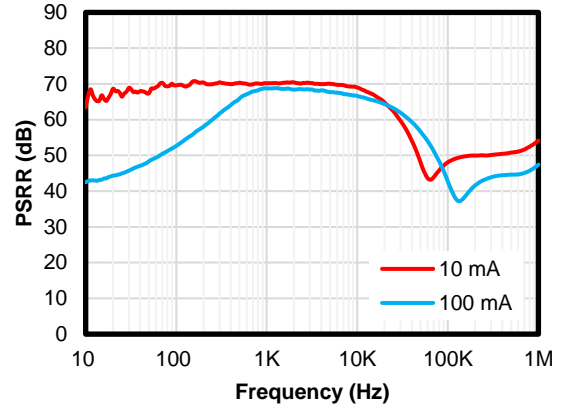
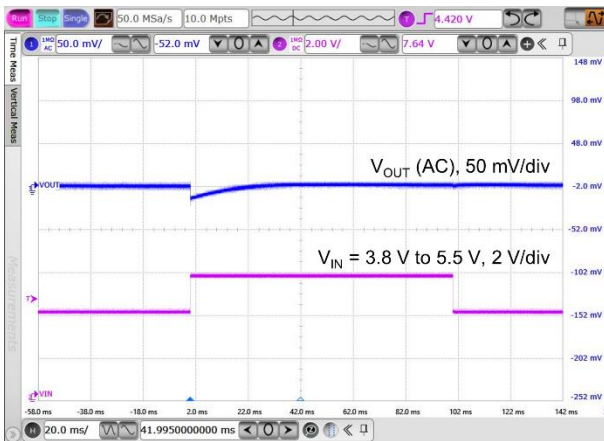

Figure 7. Load Regulation



$C_{OUT} = 10\text{ }\mu\text{F}$

Figure 8. PSRR



$V_{IN} = 3.8\text{ V to } 5.5\text{ V}$

Figure 9. Line Transient

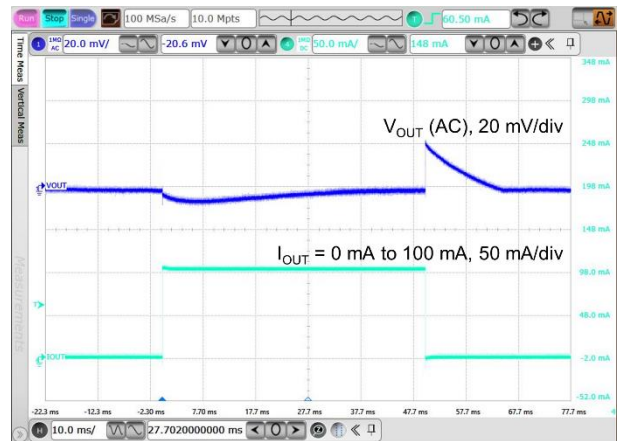

$I_{OUT} = 0\text{ mA to } 100\text{ mA}$

Figure 10. Load Transient

### Detailed Description

#### Overview

The TPL5031 series products are 300-mA high PSRR, low noise, and low dropout linear regulators with high output accuracy. The TPL5031 series products support both fixed output voltage ranges from 0.75 V to 3.6 V and adjustable output voltage ranges from 0.75 V to 5 V with an external resistor divider. The TPL5031 series products are stable with a 4.7  $\mu\text{F}$  or larger ceramic output capacitor.

The TPL5031 series products have high PSRR with 70 dB at 1 kHz. This feature makes TPL5031 series products very suitable for power-ripple-sensitive applications with high noise from the previous stage power supply, such as high-performance analog devices, or high-definition imaging equipment. Output shortage protection and thermal overload protection circuits improve the reliability under heavy load conditions.

#### Functional Block Diagram

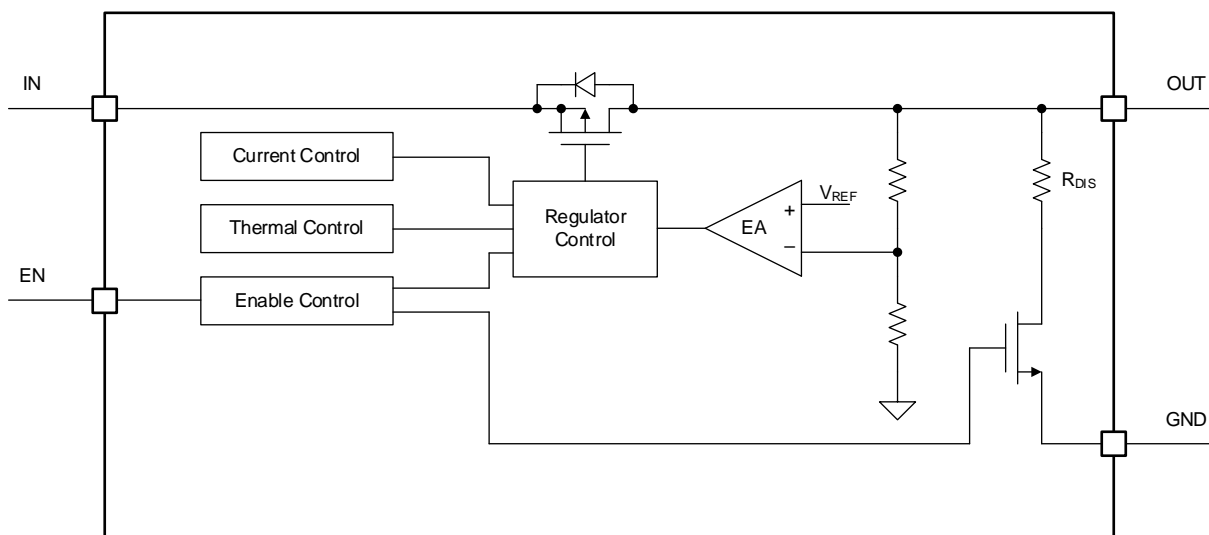

Figure 11 Functional Block Diagram

#### Feature Description

##### Enable (EN)

The enable pin (EN) is active high. Connect this pin to the GPIO of an external processor or digital logic control circuit to enable and disable the device. Or connect this pin to the IN pin for self-bias applications.

##### Regulated Output Voltage (OUT)

The TPL5031 series are available in fixed voltage versions of 0.75 V to 3.6 V. When the input voltage is higher than  $V_{\text{OUT}}(\text{NOM}) + V_{\text{DO}}$  or 1.5 V, the output pin is the regulated output based on the selected voltage version. When the input voltage falls below  $V_{\text{OUT}}(\text{NOM}) + V_{\text{DO}}$  or 1.5 V, the output pin tracks the input voltage minus the dropout voltage based on the load current.

##### Current Limit

The TPL5031 series integrates an internal current limit that helps to protect the regulator during over-load fault

**300-mA Output, High PSRR,  
Low-Dropout Linear Regulator**

conditions. When the output is overloaded, the LDO supplies a typical current of  $I_{CL}$ . The output voltage is not regulated in current limit mode, and the output voltage falls to  $V_{OUT} = I_{CL} \times R_{LOAD}$ .

**Short-Circuit Protection**

The TPL5031 series integrates a short-circuit protection. When the output pin is shorted to the ground, the output current of the TPL5031 series is limited to a typical value of  $I_{sc}$ .

**Thermal Shutdown**

During normal operation, LDO junction temperature should not exceed 125°C. When the junction temperature exceeds the thermal shutdown threshold, the LDO shuts down the output immediately. Until the junction temperature falls below the thermal shutdown threshold minus thermal shutdown hysteresis, the output turns on again.

## Application and Implementation

### NOTE

Information in the following applications sections is not part of the 3PEAK's component specification and 3PEAK does not warrant its accuracy or completeness. 3PEAK's customers are responsible for determining suitability of components for their purposes. Customers should validate and test their design implementation to confirm system functionality.

### Application Information

The TPL5031 devices are a series of 300-mA high PSRR, ultra-low noise, and low-dropout linear regulators. The following application schematic shows a typical usage of the TPL5031 series.

### Typical Application

The below figure shows the typical application schematic of the TPL5031 series.

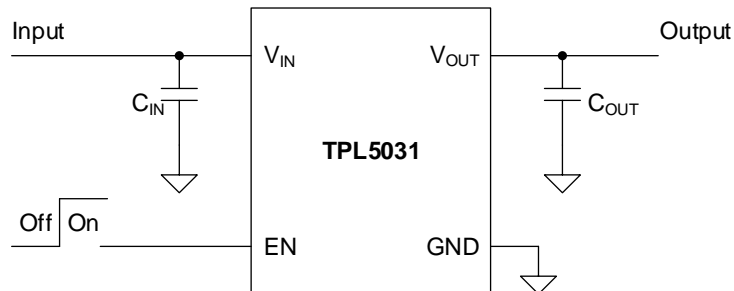

**Figure 12. Typical Application Schematic**

### Input Capacitor and Output Capacitor

3PEAK recommends adding a 1  $\mu\text{F}$  or greater capacitor with a 0.1  $\mu\text{F}$  bypass capacitor in parallel at IN pin to keep the input voltage stable. The voltage rating of the capacitors must be greater than the maximum input voltage.

To ensure loop stability, the TPL5031 series requires an output capacitor of 4.7  $\mu\text{F}$  or greater. 3PEAK recommends selecting an X5R- or X7R-type ceramic capacitor with low ESR over temperature.

Both input capacitors and output capacitors must be placed as close to the device pins as possible.

### Power Dissipation

During normal operation, LDO junction temperature should not exceed 125°C. Using the below equations to calculate the power dissipation and estimate the junction temperature.

The power dissipation can be calculated using [Equation 1](#).

$$P_D = (V_{IN} - V_{OUT}) \times I_{OUT} + V_{IN} \times I_{GND} \quad (1)$$

The junction temperature can be estimated using [Equation 2](#).  $\theta_{JA}$  is the junction-to-ambient thermal resistance.

$$T_J = T_A + P_D \times \theta_{JA} \quad (2)$$

## Layout

### Layout Guideline

- Both input capacitors and output capacitors must be placed as close to the device pins as possible.
- It is recommended to bypass the input pin to the ground with a 0.1  $\mu\text{F}$  bypass capacitor. The loop area formed by the bypass capacitor connection, IN pin, and the GND pin of the system must be as small as possible.
- It is recommended to use wide trace lengths or thick copper weight to minimize  $I \times R$  drop and heat dissipation.

### Tape and Reel Information

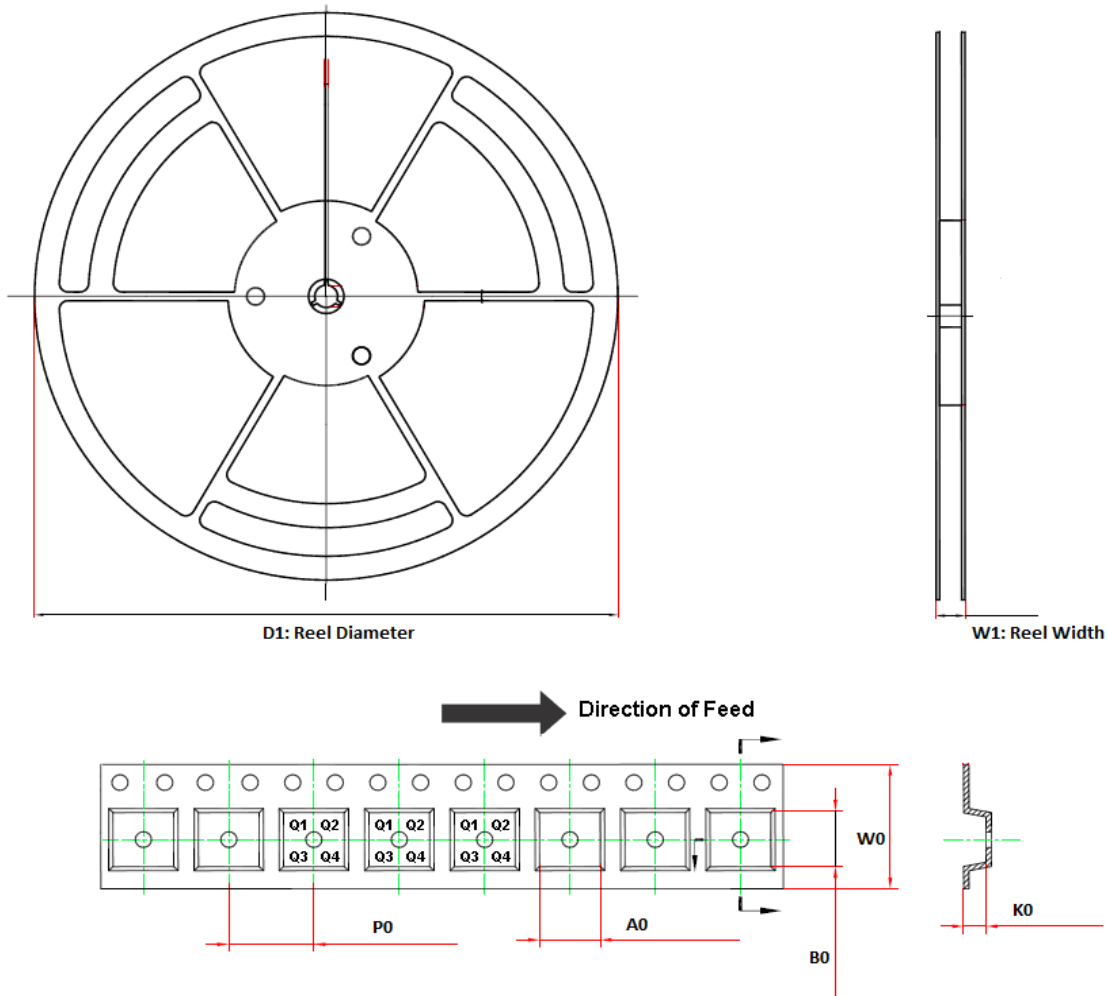

Order Number	Package	D1 (mm)	W1 (mm)	A0 (mm)	B0 (mm)	K0 (mm)	P0 (mm)	W0 (mm)	Pin1 Quadrant
TPL5031xx-S5TR <sup>(1)</sup>	SOT23-5	180.0	13.1	3.2	3.2	1.4	4.0	8.0	Q3
TPL5031xx-DF1R	1×1 DFN-4	180.0	10.0	1.16	1.16	0.5	2.0	8.0	Q1

(1) Output voltage value, xx = 075 and 08 to 50. e.g., 33 means 3.3 V output voltage.

Package Outline Dimensions

SOT23-5

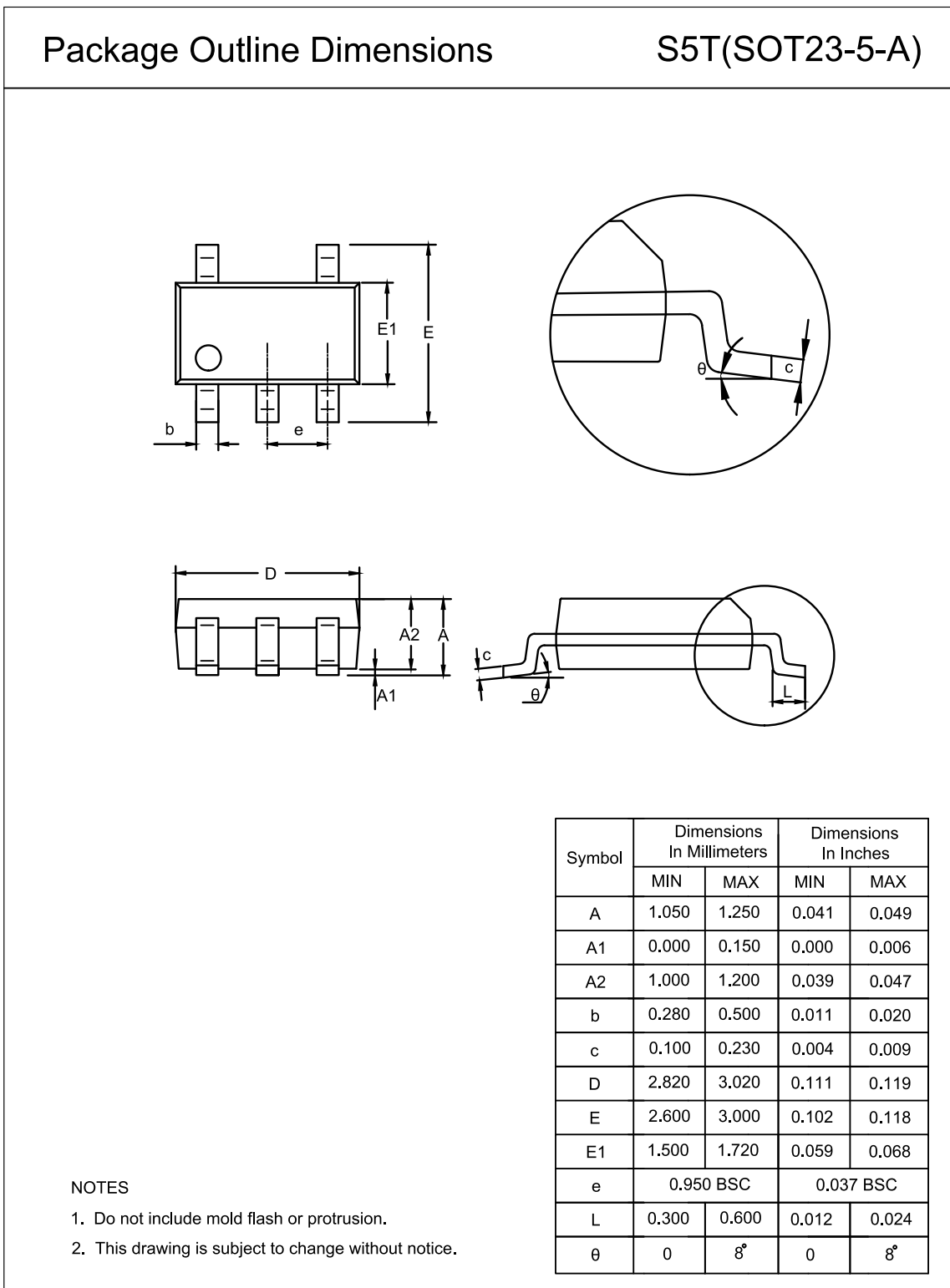

1x1 DFN-4

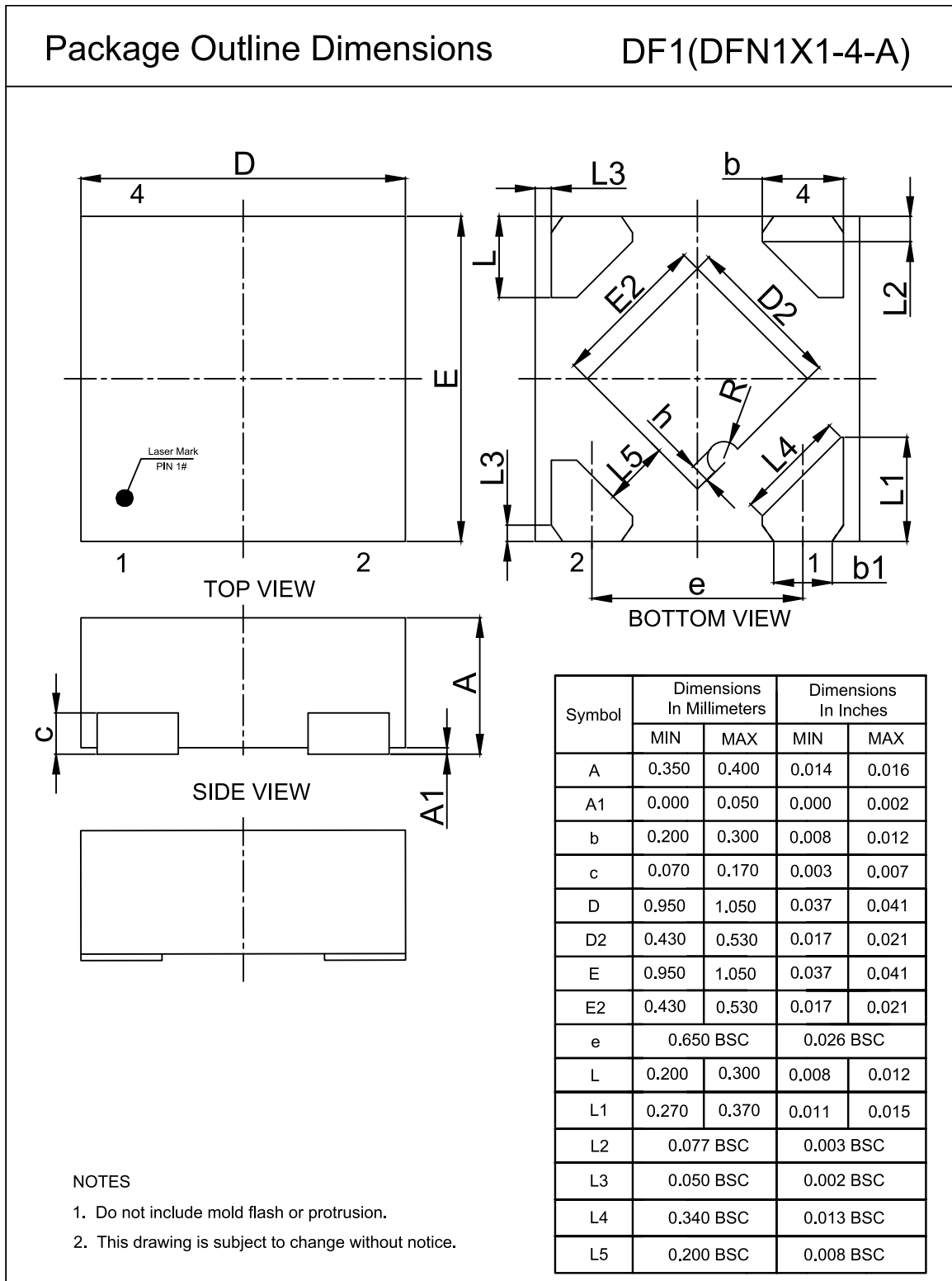



**Order Information**

Order Number	Junction Temperature Range	Package	Marking Information	MSL	Transport Media, Quantity	Eco Plan
TPL5031075-S5TR <sup>(1)</sup>	-40 to 125°C	SOT23-5	L9B	MSL3	Tape and Reel, 3,000	Green
TPL503108-S5TR	-40 to 125°C	SOT23-5	L9C	MSL3	Tape and Reel, 3,000	Green
TPL503109-S5TR <sup>(1)</sup>	-40 to 125°C	SOT23-5	L9D	MSL3	Tape and Reel, 3,000	Green
TPL5031092-S5TR <sup>(1)</sup>	-40 to 125°C	SOT23-5	L9T	MSL3	Tape and Reel, 3,000	Green
TPL503110-S5TR <sup>(1)</sup>	-40 to 125°C	SOT23-5	L9E	MSL3	Tape and Reel, 3,000	Green
TPL503111-S5TR <sup>(1)</sup>	-40 to 125°C	SOT23-5	L9F	MSL3	Tape and Reel, 3,000	Green
TPL503112-S5TR	-40 to 125°C	SOT23-5	L9G	MSL3	Tape and Reel, 3,000	Green
TPL503115-S5TR	-40 to 125°C	SOT23-5	L9H	MSL3	Tape and Reel, 3,000	Green
TPL503118-S5TR	-40 to 125°C	SOT23-5	L9I	MSL3	Tape and Reel, 3,000	Green
TPL503121-S5TR <sup>(1)</sup>	-40 to 125°C	SOT23-5	L9J	MSL3	Tape and Reel, 3,000	Green
TPL503125-S5TR	-40 to 125°C	SOT23-5	L9K	MSL3	Tape and Reel, 3,000	Green
TPL503127-S5TR <sup>(1)</sup>	-40 to 125°C	SOT23-5	L9L	MSL3	Tape and Reel, 3,000	Green
TPL503128-S5TR	-40 to 125°C	SOT23-5	L9M	MSL3	Tape and Reel, 3,000	Green
TPL503129-S5TR <sup>(1)</sup>	-40 to 125°C	SOT23-5	L9N	MSL3	Tape and Reel, 3,000	Green
TPL503130-S5TR <sup>(1)</sup>	-40 to 125°C	SOT23-5	L9P	MSL3	Tape and Reel, 3,000	Green
TPL503133-S5TR	-40 to 125°C	SOT23-5	L9Q	MSL3	Tape and Reel, 3,000	Green
TPL503136-S5TR <sup>(1)</sup>	-40 to 125°C	SOT23-5	L9R	MSL3	Tape and Reel, 3,000	Green

(1) Future product, contact 3PEAK factory for more information and sample.

(2) Green: 3PEAK defines "Green" to mean RoHS compatible and free of halogen substances.

**300-mA Output, High PSRR, Low-Dropout Linear Regulator**

Order Number	Junction Temperature Range	Package	Marking Information	MSL	Transport Media, Quantity	Eco Plan
TPL5031075-DF1R <sup>(1)</sup>	-40 to 125°C	1×1 DFN-4	L9B	MSL3	Tape and Reel, 12,000	Green
TPL503108-DF1R <sup>(1)</sup>	-40 to 125°C	1×1 DFN-4	L9C	MSL3	Tape and Reel, 12,000	Green
TPL503109-DF1R <sup>(1)</sup>	-40 to 125°C	1×1 DFN-4	L9D	MSL3	Tape and Reel, 12,000	Green
TPL5031092-DF1R <sup>(1)</sup>	-40 to 125°C	1×1 DFN-4	L9T	MSL3	Tape and Reel, 12,000	Green
TPL503110-DF1R <sup>(1)</sup>	-40 to 125°C	1×1 DFN-4	L9E	MSL3	Tape and Reel, 12,000	Green
TPL503111-DF1R <sup>(1)</sup>	-40 to 125°C	1×1 DFN-4	L9F	MSL3	Tape and Reel, 12,000	Green
TPL503112-DF1R <sup>(1)</sup>	-40 to 125°C	1×1 DFN-4	L9G	MSL3	Tape and Reel, 12,000	Green
TPL503115-DF1R <sup>(1)</sup>	-40 to 125°C	1×1 DFN-4	L9H	MSL3	Tape and Reel, 12,000	Green
TPL503118-DF1R <sup>(1)</sup>	-40 to 125°C	1×1 DFN-4	L9I	MSL3	Tape and Reel, 12,000	Green
TPL503121-DF1R <sup>(1)</sup>	-40 to 125°C	1×1 DFN-4	L9J	MSL3	Tape and Reel, 12,000	Green
TPL503125-DF1R <sup>(1)</sup>	-40 to 125°C	1×1 DFN-4	L9K	MSL3	Tape and Reel, 12,000	Green
TPL503127-DF1R <sup>(1)</sup>	-40 to 125°C	1×1 DFN-4	L9L	MSL3	Tape and Reel, 12,000	Green
TPL503128-DF1R <sup>(1)</sup>	-40 to 125°C	1×1 DFN-4	L9M	MSL3	Tape and Reel, 12,000	Green
TPL503129-DF1R <sup>(1)</sup>	-40 to 125°C	1×1 DFN-4	L9N	MSL3	Tape and Reel, 12,000	Green
TPL503130-DF1R <sup>(1)</sup>	-40 to 125°C	1×1 DFN-4	L9P	MSL3	Tape and Reel, 12,000	Green
TPL503133-DF1R <sup>(1)</sup>	-40 to 125°C	1×1 DFN-4	L9Q	MSL3	Tape and Reel, 12,000	Green
TPL503136-DF1R <sup>(1)</sup>	-40 to 125°C	1×1 DFN-4	L9R	MSL3	Tape and Reel, 12,000	Green

(1) Future product, contact 3PEAK factory for more information and sample.

(2) Green: 3PEAK defines "Green" to mean RoHS compatible and free of halogen substances.

## IMPORTANT NOTICE AND DISCLAIMER

**Copyright**© 3PEAK 2012-2023. All rights reserved.

**Trademarks.** Any of the 思瑞浦 or 3PEAK trade names, trademarks, graphic marks, and domain names contained in this document /material are the property of 3PEAK. You may NOT reproduce, modify, publish, transmit or distribute any Trademark without the prior written consent of 3PEAK.

**Performance Information.** Performance tests or performance range contained in this document/material are either results of design simulation or actual tests conducted under designated testing environment. Any variation in testing environment or simulation environment, including but not limited to testing method, testing process or testing temperature, may affect actual performance of the product.

**Disclaimer.** 3PEAK provides technical and reliability data (including data sheets), design resources (including reference designs), application or other design recommendations, networking tools, security information and other resources "As Is". 3PEAK makes no warranty as to the absence of defects, and makes no warranties of any kind, express or implied, including without limitation, implied warranties as to merchantability, fitness for a particular purpose or non-infringement of any third-party's intellectual property rights. Unless otherwise specified in writing, products supplied by 3PEAK are not designed to be used in any life-threatening scenarios, including critical medical applications, automotive safety-critical systems, aviation, aerospace, or any situations where failure could result in bodily harm, loss of life, or significant property damage. 3PEAK disclaims all liability for any such unauthorized use.