

Distance-setting Photoelectric Sensor

E3G-L1/L3

Pin-point Beam, Adjustable Focus Point and Teach Mode for Reliable Detection

- Teach mode speeds accurate setup
- Smallest pin-point beam in the industry allows detection of minute objects
- Optical system achieves stable detection of objects regardless of glossiness, color, material, surface irregularities, or inclination
- Connector and cabled models
- Rugged IP67, NEMA 4 enclosure
- Selectable Light-ON/Dark-ON operation



Ordering Information

■ SENSORS

Appearance	Supply voltage	Light source	Connection method	Sensing/Setting range	Part number	
					NPN	PNP
	10-30 VDC	Red	Pre-leaded		E3G-L11	E3G-L12
			Connector		E3G-L15	E3G-L16
		Infrared	Pre-leaded		E3G-L31	E3G-L32
			Connector		E3G-L35	E3G-L36

■ CONNECTOR CORDSETS

Shape	Description	Cable length	Part number
Straight	Four-wire, vibration-proof, single-ended cable	2 m (6.56 ft)	XS3F-M421-402-R
		5 m (16.40 ft)	XS3F-M421-405-R
Right angle		2 m (6.56 ft)	XS3F-M422-402-R
		5 m (16.40 ft)	XS3F-M422-405-R

REPLACEMENT PARTS

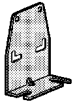
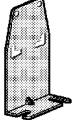
Mounting brackets	Remarks	Part number
	Provided with E3G-L□1/-L□2	E39-L139
	Provided with E3G-L□5/-L□6	E39-L140

Specifications

Ratings/Characteristics

Sensing method		Diffuse			
Part number	NPN output	E3G-L11	E3G-L15	E3G-L31	E3G-L35
	PNP output	E3G-L12	E3G-L16	E3G-L32	E3G-L36
Setting range		30 to 50 mm (1.18 to 1.97 in) (Kodak white paper, black paper: 50 x 50 mm)		50 to 200 mm (1.97 to 7.87 in) (Kodak white paper 50 x 50 mm) 50 to 150 mm (1.97 to 5.91 in) (black paper 50 x 50 mm)	
Sensing range		5 to 50 mm (0.20 to 1.97 in) (Kodak white paper 50 x 50 mm, setting distance 50 mm)		5 to 200 mm (0.20 to 7.87 in) (Kodak white paper 50 x 50 mm, setting distance 200 mm) 5 to 150 mm (0.20 to 5.91 in) (black paper 50 x 50 mm, setting distance 150 mm)	
Differential travel		4% max. of sensing distance		10% of sensing distance (typical)	
Reflectivity characteristics (black/white differential)		4% max. of sensing distance		10% max. of sensing distance (at 50 to 150 mm setting distance)	
Light source (wavelength)		Red LED (670 nm)		Infrared LED (860 nm)	
Spot size		1 mm dia. max. (at 38 mm sensing distance)		15 mm dia. max. (at 150 mm sensing distance)	
Supply voltage		10 to 30 VDC max. 10% (p-p) ripple			
Stabilization on powerup		100 ms			
Current consumption		55 mA max.		65 mA max.	
Control output		100 mA max. at 30 VDC Residual voltage: NPN output: 1.2 V max. PNP output: 2.0 V max. Open collector output (NPN/PNP, differs depending on models) Light-ON/Dark-ON selectable			
Circuit protection		Protection from reversed power supply connection, load short-circuit, and mutual interference			
Response time		Operation or reset: 1.5 ms max.		Operation or reset: 2.5 ms max.	
Distance setting		Teaching (in NORMAL or ZONE mode)			
Fine distance adjustment		Manual fine threshold adjustment (NORMAL mode: 13 levels/ZONE mode: 5 levels)			
Indicator		Operation indicator (orange LED), distance indicator (green LED: 8 levels), threshold indicator (red LED, NORMAL mode: 13 levels/ZONE mode: 5 levels)			
Ambient light immunity (receiver side)		Incandescent lamp: 3,000 lx max./Sunlight: 10,000 lx max.			
Ambient temperature	Operating	-25°C to 55°C (-13°F to 131°F) with no icing or condensation			
	Storage	-30°C to 70°C (-22°F to 158°F) with no icing or condensation			
Relative humidity	Operating	35% to 85% with no condensation			
	Storage	35% to 95% with no condensation			
Insulation resistance		20 MΩ min. at 500 VDC			
Dielectric strength		1,000 VAC, 50/60 Hz for 1 min.			
Vibration resistance		10 to 55 Hz, 1.5 mm double amplitude for 2 hours each in X, Y and Z axes			
Shock resistance		500m/s ² , 3 times each in X, Y and Z axes			
Degree of protection		IEC60529 IP67 (with protective cover) in place			

(This table continues on the next page.)

Specifications Table - continued from previous page

Sensing method	Diffuse				
Part number	NPN output	E3G-L11	E3G-L15	E3G-L31	E3G-L35
	PNP output	E3G-L12	E3G-L16	E3G-L32	E3G-L36
Connection method	Pre-leaded (standard length: 2 m)		M8 connector	Pre-leaded (standard length: 2 m)	
Weight (packed state)	Approx. 64 g		Approx. 21 g	Approx. 64 g	
Material	Case: PBT (polybutylene terephthalate). Lens: Acrylic (PMMA). Mounting bracket: Stainless steel (SUS304)				
Accessories included	Mounting bracket (with screws) and instruction sheet				

Operation

OUTPUT CIRCUITS

Output configuration	NPN		PNP	
Part number	E3G-L11 E3G-L15 E3G-L31 E3G-L35		E3G-L12 E3G-L16 E3G-L32 E3G-L36	
Output operation	Light-ON	Dark-ON	Light-ON	Dark-ON
Timing chart				
Mode selector	L-ON (Light-ON)	D-ON (Dark-ON)	L-ON (Light-ON)	D-ON (Dark-ON)
Output circuit	<p>Connector Pin Arrangement</p>		<p>Connector Pin Arrangement</p>	

CONNECTOR WIRING

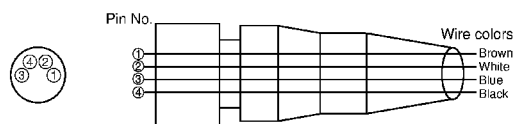

- XS3F-M421-402-R
- XS3F-M421-405-R
- XS3F-M422-402-R
- XS3F-M422-405-R

Classification	Wire color	Connector pin number	Use
DC	Brown	1	Power supply (+ V)
	White	2	Pin 2 is not used.
	Blue	3	Power supply (0 V)
	Black	4	Output

Engineering Data

OPERATING RANGE

E3G-L1 (in NORMAL Mode)

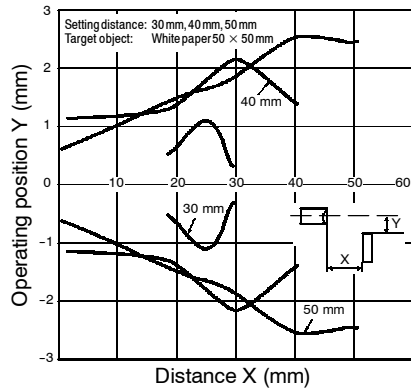

E3G-L1 (in ZONE Mode)

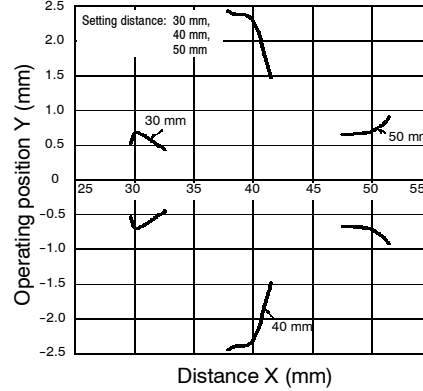

E3G-L3 (in NORMAL Mode)

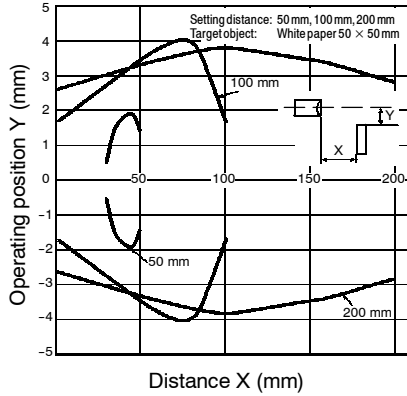

E3G-L3 (in ZONE Mode)

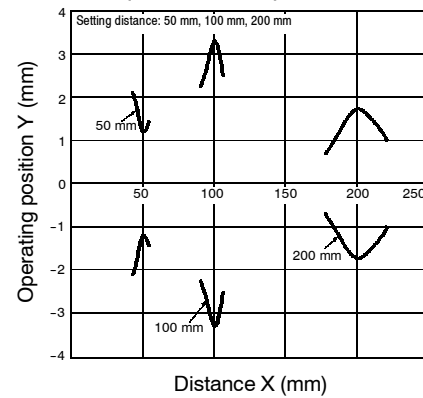

SPOT DIAMETER VS. SENSING DISTANCE

E3G-L1

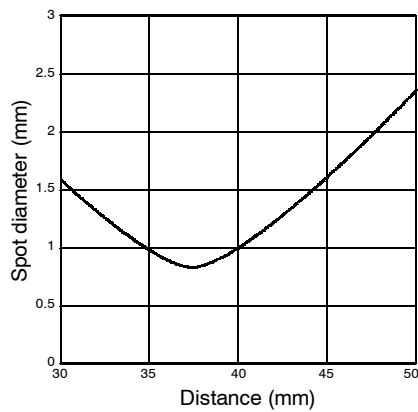

E3G-L3

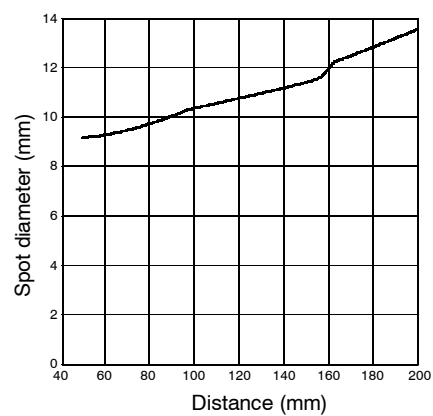

ANGLE CHARACTERISTICS

E3G-L1□ (Up and Down)

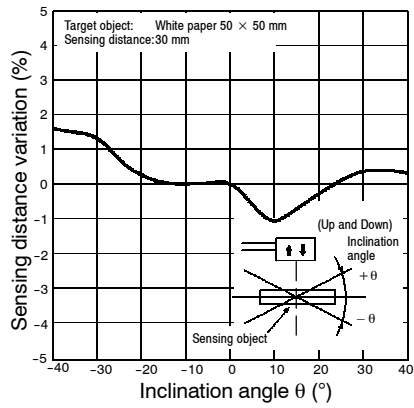

E3G-L1□ (Left and Right)

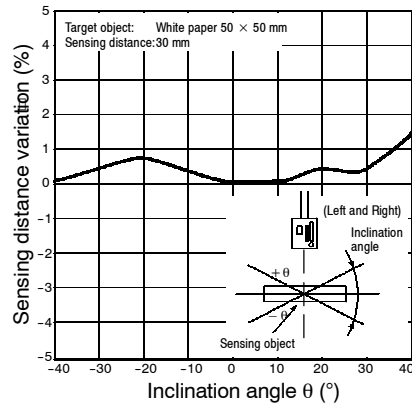

E3G-L1□ (Up and Down)

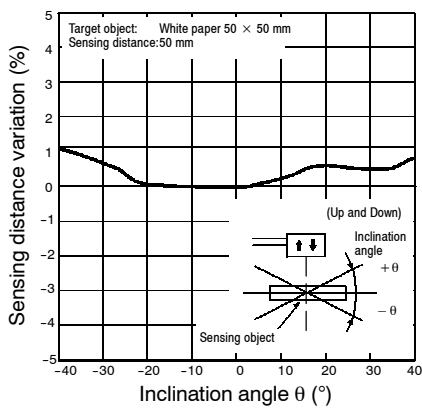

E3G-L1□ (Left and Right)

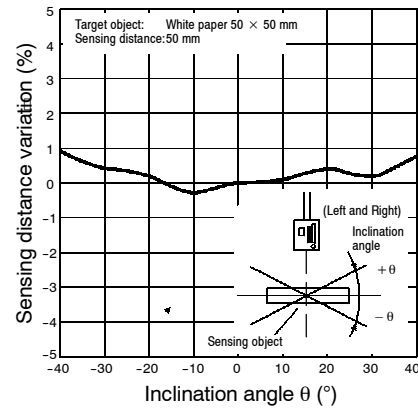

E3G-L3□ (Up and Down)

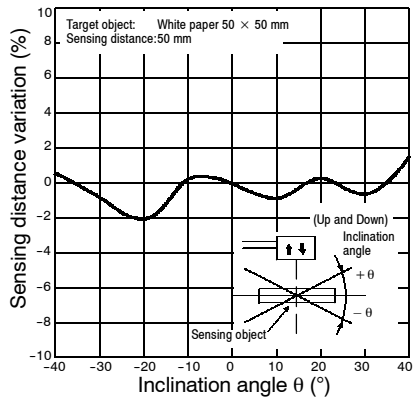

E3G-L3□ (Left and Right)

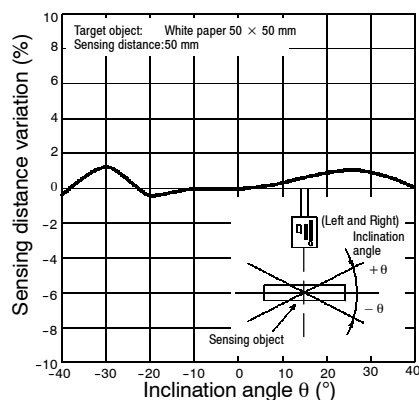

■ ANGLE CHARACTERISTICS (CONT.)

E3G-L3 □ (Up and Down)

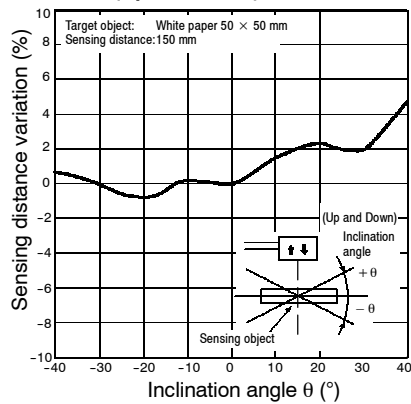

E3G-L3 □ (Left and Right)

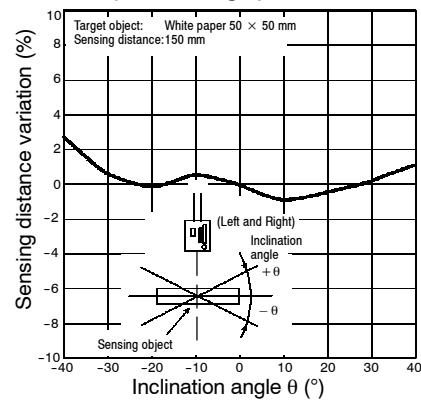

■ TARGET OBJECT SIZE VS. SETTING DISTANCE

E3G-L1 □

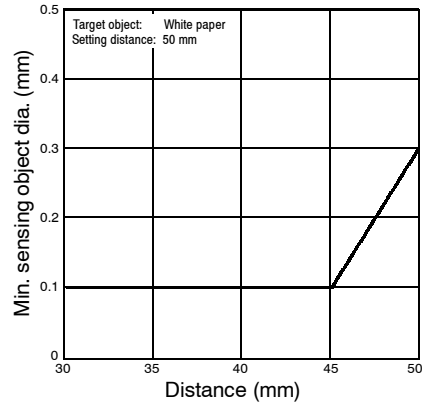

E3G-L3 □

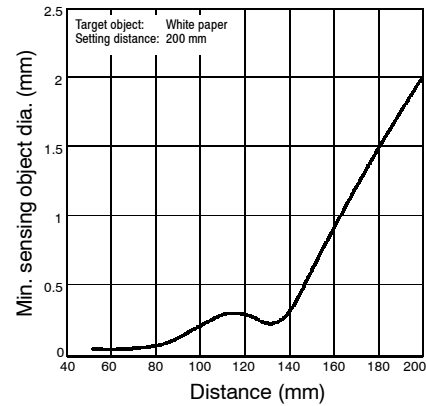

■ CLOSE-RANGE CHARACTERISTICS

E3G-L1 □

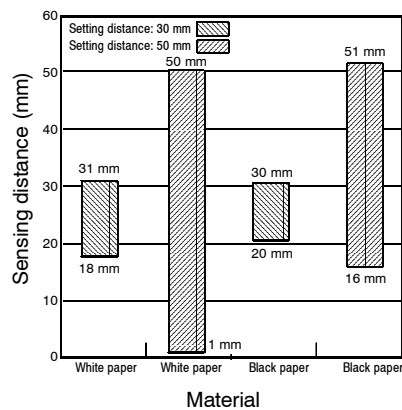

E3G-L3 □

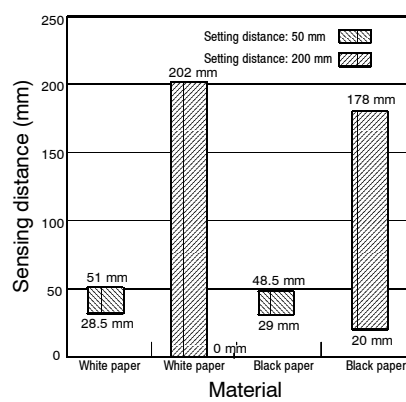

■ SENSING DISTANCE VS. SENSING OBJECT MATERIAL

E3G-L1 (at 30 mm Setting Distance)

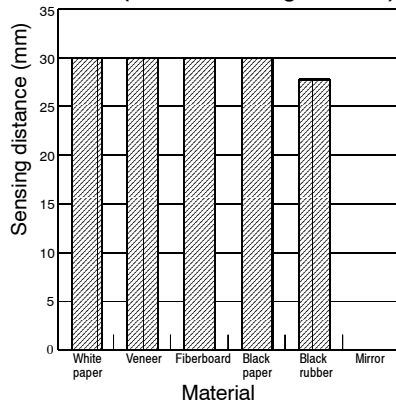

E3G-L1 (at 40 mm Setting Distance)

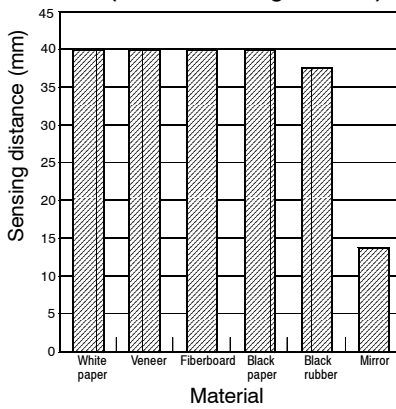

E3G-L1 (at 50 mm Setting Distance)

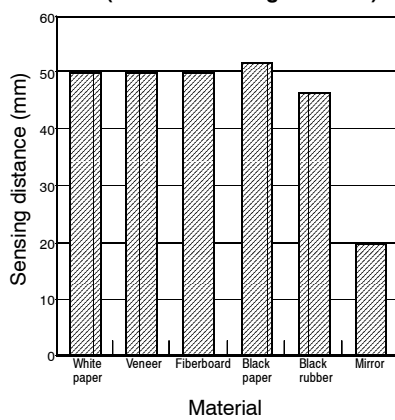

E3G-L3 (at 50 mm Setting Distance)

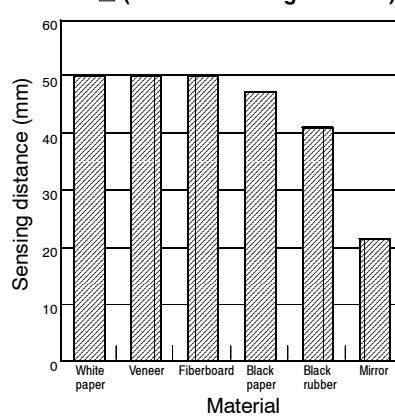

E3G-L3 (at 100 mm Setting Distance)

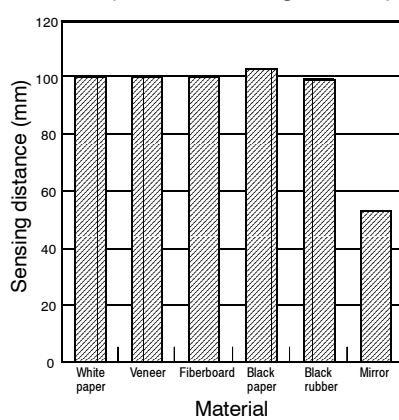

E3G-L3 (at 150 mm Setting Distance)

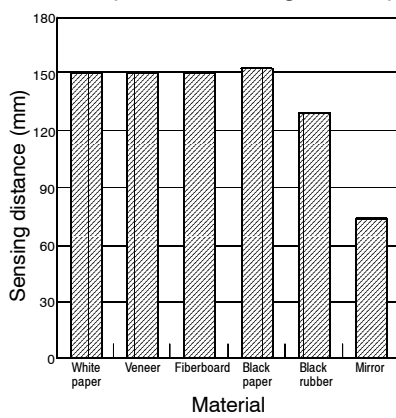

Nomenclature

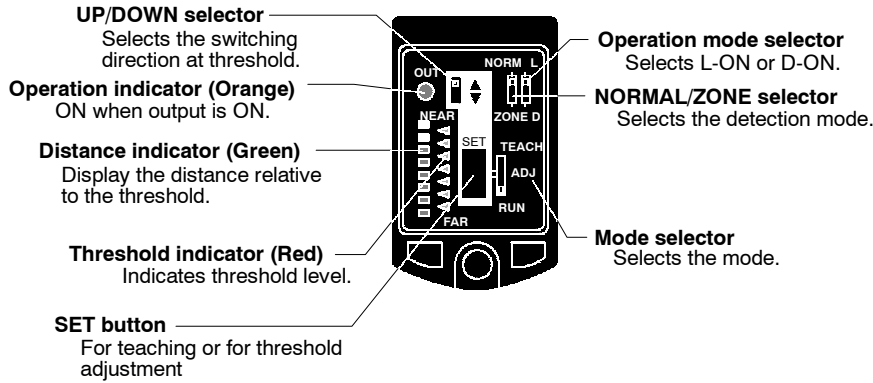

Installation

■ MOUNTING DIRECTIONS

Non-shiny Targets

Make sure the sensing side of the sensor is parallel with the surface of the target object. Do not tilt the sensor towards the target object.

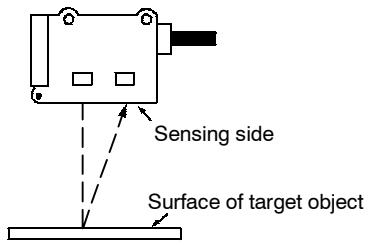

Shiny Targets

If the target object has a glossy surface, incline the sensor by 5° to 10° as shown below, provided that the sensor is not influenced by any background objects.

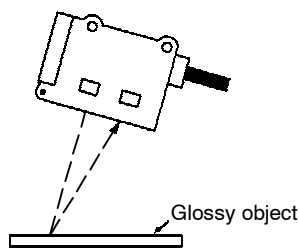

If there is a mirror-like object below the sensor, the sensor may not be in stable operation. Tilt the sensor or keep the sensor far enough away from the mirror-like object to avoid interfering reflections as shown below.

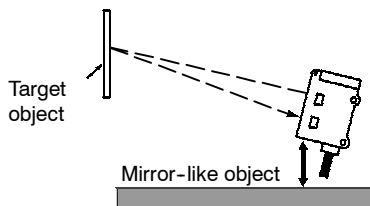

Make sure not to install the sensor in the incorrect direction. Refer to the following.

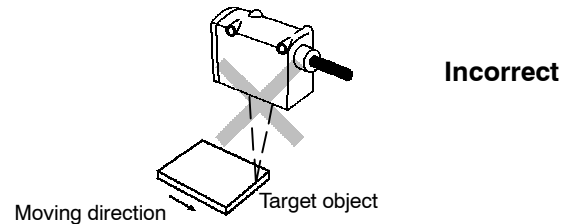
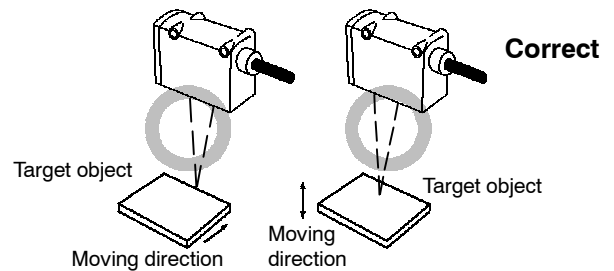

Install the sensor as shown in the following if the target object greatly differs in color or material.

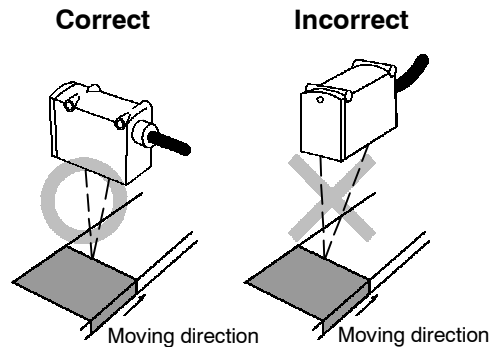

ADJUSTMENTS

If the sensor is not in stable operation due to color differences, make a fine adjustment of the threshold level and confirm that the sensor operates in stable state. Refer to *Manual Teaching (Fine Distance Setting)*.

Adjustment Steps

1	Install, wire, and turn on the sensor.
2	Perform distance setting (teaching). Refer to <i>Distance Setting (Teaching)</i> below.
3	Make a fine adjustment of the threshold, if necessary. Refer to <i>Manual Teaching (Fine Distance Setting)</i>
4	Check that the mode selector is set to RUN.

Distance Setting (Teaching)

Select the most appropriate teaching method in reference to the following descriptions.

Application	1	2	3
	<ul style="list-style-type: none"> Teaching without sensing objects (i.e., Teaching the background). 	<ul style="list-style-type: none"> Detection of slight differences in surface level. Setting a threshold in the middle between the background and sensing object for operation. 	<ul style="list-style-type: none"> Detection of glossy objects in front of the background.

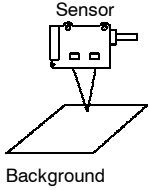
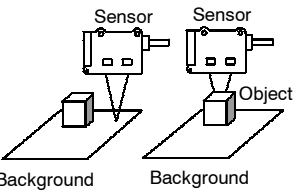
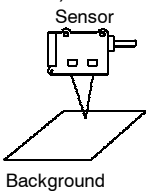
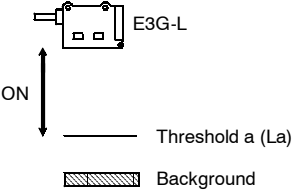
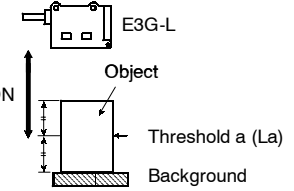
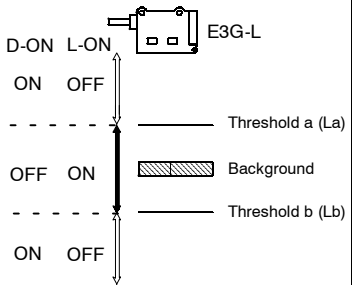
Teaching	1	2	3
	Normal one-point teaching	Normal two-point teaching	Zone one-point teaching
Setting method	<p>Press the TEACH button with the background object present.</p> 	<p>Press the TEACH button with the background object and with the target object.</p> 	<p>Press the TEACH button with the background object (conveyor, etc.).</p> 
Set threshold	Threshold (a) is set immediately in front of the background.	Threshold (a) is set approximately in the middle between the background and target object.	A pair of thresholds, (a) and (b), are set.
Output ON range	<p>The output is ON between the sensor and La.</p> 	<p>The output is ON between the sensor and La.</p> 	<p>The output is ON between La and Lb.</p> 

La: Distance equivalent to threshold (a)
 Lb: Distance equivalent to threshold (b)
 The following settings are also possible:
 Setting the maximum sensing distance of the sensor: Maximum distance setting.
 Setting the minimum differential travel of the sensor: Minimum distance setting.
 Distance from sensor to background must not exceed the values shown below during normal one-point or zone one-point teaching.

Part number	Distance from sensor to background
E3G-L1□	32 mm (1.26 in) min.
E3G-L3□	55 mm (2.17 in) min.

Maximum sensing distance of E3G-L3 type may differ by color of the target object when setting distance is more than 150 mm (5.91 in).
 Confirm the operation of the sensor before actual operation.

■ ADJUSTMENTS (CONT.)

Normal One-point Teaching

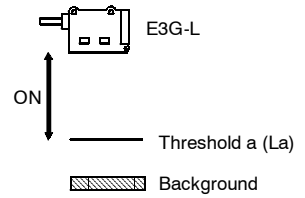
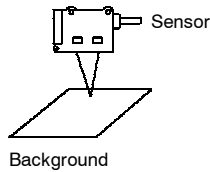

Procedure	Operation	Panel status
1	Set the mode selector to TEACH.	
2	Set the NORMAL/ZONE mode selector to NORMAL.	
3	Press the SET button with the background. The threshold indicator (red) will turn ON.	
4	Set the mode selector to RUN.	
5	Set to L-ON or D-ON mode with the operation mode selector. L-ON: Output ON between background and sensor. D-ON: Output OFF between background and sensor.	
Application Example 1 Adjusting the sensor differential travel to the minimum distance.		
1	Set the mode selector to TEACH.	
2	Set the NORMAL/ZONE mode selector to NORMAL.	
3	Set the UP/DOWN selector to down.	
4	Press the SET button for 3 s or more. The threshold indicator (red) will turn ON.	
5	The distance indicator (green) will turn ON. This means that teaching is successful. Set the mode selector to RUN to complete the teaching operation.	
6	Set to L-ON or D-ON mode with the operation mode selector.	
Application Example 2 Setting the sensor to the maximum distance.		
1	Set the mode selector to TEACH.	
2	Set the NORMAL/ZONE mode selector to NORMAL.	
3	Set the UP/DOWN selector to up.	
4	Press the SET button for 3 s or more. The threshold indicator (red) will turn ON.	
5	The distance indicator (green) will turn ON. This means that teaching is successful. Set the mode selector to RUN to complete the teaching operation.	
6	Set to L-ON or D-ON mode with the operation mode selector.	

La: Distance equivalent to threshold (a)

ADJUSTMENTS (CONT.)

Normal Two-point Teaching

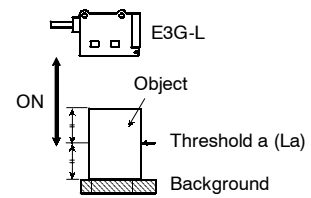
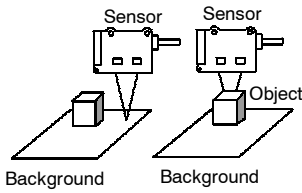

Procedure	Operation	Panel status
1	Set the mode selector to TEACH.	
2	Set the NORMAL/ZONE mode selector to NORMAL.	
3	Press the SET button with a sensing object located at sensing position. The threshold indicator (red) will turn ON.	
4	Move the sensing object and press the SET button with the background. If the teaching is successful, the distance indicator (green) will turn ON. If the teaching is not successful, the threshold indicator (red) will start to flash.	
5	If the teaching is successful, set the mode selector to RUN to complete the teaching operation. If the teaching is not successful, change the position of the object and setting distance that have been set and repeat the procedure from step 3 above.	
6	Set to L-ON or D-ON mode with the operation mode selector.	

La: Distance equivalent to threshold (a)

ADJUSTMENTS (CONT.)

Zone One-point Teaching

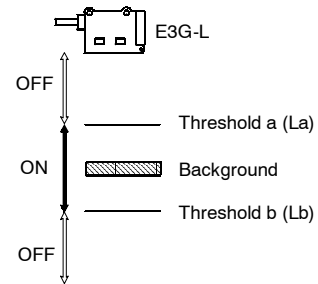
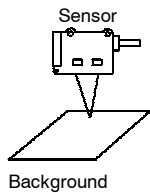

Procedure	Operation	Panel status
1	Set the mode selector to TEACH.	
2	Set the NORMAL/ZONE mode selector to ZONE.	
3	Press the SET button with the background. All threshold indicators (Red) will turn ON while the SET button is pressed. When the SET button is released: • If the teaching is successful, the distance indicator (green) will turn ON. • If the teaching is not successful, the threshold indicator (red) will start to flash.	
4	Set the mode selector to RUN.	
5	Set to L-ON or D-ON mode with the operation mode selector. L-ON: Output ON with the background. D-ON: Output OFF with the background.	

La: Distance equivalent to threshold (a)

■ ADJUSTMENTS (CONT.)

Manual Teaching (Fine Distance Setting)

Procedure	Operation	Panel status																																								
<p>Fine adjustment of the threshold is possible after teaching.</p>																																										
1	Set the mode selector to ADJ.	<p>SET pressed with UP/DOWN selector set to UP. Threshold increases</p> <p>SET pressed with UP/DOWN selector set to DOWN. Threshold decreases</p>																																								
2	Set the adjustment direction in the ADJ mode with the UP/DOWN selector. The threshold changes each time the SET button is pressed. The setting can be made in up to 13 levels (for normal one-point or two-point teaching).	<p>Threshold Indicator Display During Distance Adjustment</p> <p>Max. 13 adjustment levels for normal teaching</p> <table border="1"> <tr> <td>▲▲▲▲▲▲▲▲▲▲▲▲▲▲▲▲</td> <td>▲▲▲▲▲▲▲▲▲▲▲▲▲▲▲▲</td> <td>▲▲▲▲▲▲▲▲▲▲▲▲▲▲▲▲</td> <td>▲▲▲▲▲▲▲▲▲▲▲▲▲▲▲▲</td> <td>▲▲▲▲▲▲▲▲▲▲▲▲▲▲▲▲</td> <td>▲▲▲▲▲▲▲▲▲▲▲▲▲▲▲▲</td> <td>▲▲▲▲▲▲▲▲▲▲▲▲▲▲▲▲</td> <td>▲▲▲▲▲▲▲▲▲▲▲▲▲▲▲▲</td> <td>▲▲▲▲▲▲▲▲▲▲▲▲▲▲▲▲</td> <td>▲▲▲▲▲▲▲▲▲▲▲▲▲▲▲▲</td> <td>▲▲▲▲▲▲▲▲▲▲▲▲▲▲▲▲</td> <td>▲▲▲▲▲▲▲▲▲▲▲▲▲▲▲▲</td> <td>▲▲▲▲▲▲▲▲▲▲▲▲▲▲▲▲</td> <td>▲▲▲▲▲▲▲▲▲▲▲▲▲▲▲▲</td> <td>▲▲▲▲▲▲▲▲▲▲▲▲▲▲▲▲</td> </tr> <tr> <td>1</td> <td>2</td> <td>3</td> <td>4</td> <td>5</td> <td>6</td> <td>7</td> <td>8</td> <td>9</td> <td>10</td> <td>11</td> <td>12</td> <td>13</td> <td></td> <td></td> </tr> </table> <p>Five adjustment levels for zone teaching</p> <table border="1"> <tr> <td>▲▲▲▲▲▲▲▲▲▲▲▲▲▲▲▲</td> <td>▲▲▲▲▲▲▲▲▲▲▲▲▲▲▲▲</td> <td>▲▲▲▲▲▲▲▲▲▲▲▲▲▲▲▲</td> <td>▲▲▲▲▲▲▲▲▲▲▲▲▲▲▲▲</td> <td>▲▲▲▲▲▲▲▲▲▲▲▲▲▲▲▲</td> </tr> <tr> <td>1</td> <td>2</td> <td>3</td> <td>4</td> <td>5</td> </tr> </table>	▲▲▲▲▲▲▲▲▲▲▲▲▲▲▲▲	▲▲▲▲▲▲▲▲▲▲▲▲▲▲▲▲	▲▲▲▲▲▲▲▲▲▲▲▲▲▲▲▲	▲▲▲▲▲▲▲▲▲▲▲▲▲▲▲▲	▲▲▲▲▲▲▲▲▲▲▲▲▲▲▲▲	▲▲▲▲▲▲▲▲▲▲▲▲▲▲▲▲	▲▲▲▲▲▲▲▲▲▲▲▲▲▲▲▲	▲▲▲▲▲▲▲▲▲▲▲▲▲▲▲▲	▲▲▲▲▲▲▲▲▲▲▲▲▲▲▲▲	▲▲▲▲▲▲▲▲▲▲▲▲▲▲▲▲	▲▲▲▲▲▲▲▲▲▲▲▲▲▲▲▲	▲▲▲▲▲▲▲▲▲▲▲▲▲▲▲▲	▲▲▲▲▲▲▲▲▲▲▲▲▲▲▲▲	▲▲▲▲▲▲▲▲▲▲▲▲▲▲▲▲	▲▲▲▲▲▲▲▲▲▲▲▲▲▲▲▲	1	2	3	4	5	6	7	8	9	10	11	12	13			▲▲▲▲▲▲▲▲▲▲▲▲▲▲▲▲	▲▲▲▲▲▲▲▲▲▲▲▲▲▲▲▲	▲▲▲▲▲▲▲▲▲▲▲▲▲▲▲▲	▲▲▲▲▲▲▲▲▲▲▲▲▲▲▲▲	▲▲▲▲▲▲▲▲▲▲▲▲▲▲▲▲	1	2	3	4	5
▲▲▲▲▲▲▲▲▲▲▲▲▲▲▲▲	▲▲▲▲▲▲▲▲▲▲▲▲▲▲▲▲	▲▲▲▲▲▲▲▲▲▲▲▲▲▲▲▲	▲▲▲▲▲▲▲▲▲▲▲▲▲▲▲▲	▲▲▲▲▲▲▲▲▲▲▲▲▲▲▲▲	▲▲▲▲▲▲▲▲▲▲▲▲▲▲▲▲	▲▲▲▲▲▲▲▲▲▲▲▲▲▲▲▲	▲▲▲▲▲▲▲▲▲▲▲▲▲▲▲▲	▲▲▲▲▲▲▲▲▲▲▲▲▲▲▲▲	▲▲▲▲▲▲▲▲▲▲▲▲▲▲▲▲	▲▲▲▲▲▲▲▲▲▲▲▲▲▲▲▲	▲▲▲▲▲▲▲▲▲▲▲▲▲▲▲▲	▲▲▲▲▲▲▲▲▲▲▲▲▲▲▲▲	▲▲▲▲▲▲▲▲▲▲▲▲▲▲▲▲	▲▲▲▲▲▲▲▲▲▲▲▲▲▲▲▲																												
1	2	3	4	5	6	7	8	9	10	11	12	13																														
▲▲▲▲▲▲▲▲▲▲▲▲▲▲▲▲	▲▲▲▲▲▲▲▲▲▲▲▲▲▲▲▲	▲▲▲▲▲▲▲▲▲▲▲▲▲▲▲▲	▲▲▲▲▲▲▲▲▲▲▲▲▲▲▲▲	▲▲▲▲▲▲▲▲▲▲▲▲▲▲▲▲																																						
1	2	3	4	5																																						
3	After the adjustment is complete, set the mode selector to RUN.																																									

Threshold and Distance Indicator Displays

Display for Distance Setting with Normal One-point or Two-point Teaching

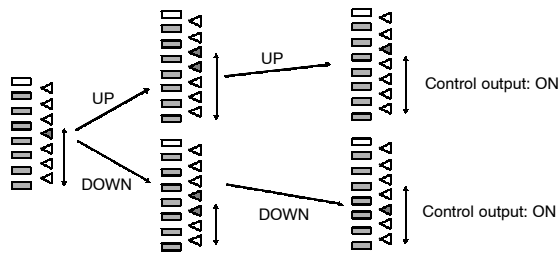

The distance indicators show the distance level. The distance indicators show distances relative to the threshold.

The threshold can be shifted using the UP/DOWN selector and SET button. The differential travel is fixed.

Display for Distance Setting with Zone Teaching

The distance indicators show the current distance band. The distance indicators show distances relative to the threshold.

The ON range can be shifted using the UP/DOWN selector and SET button. The differential travel is fixed.

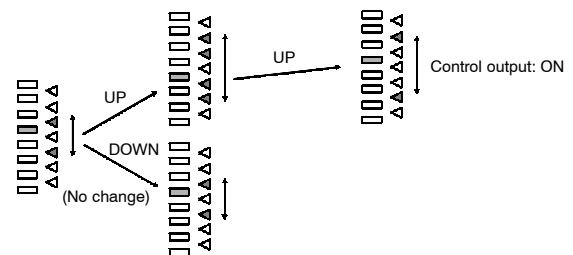

Dimensions

Unit: mm (inch)

SENSORS

Preleaded Models

E3G-L11/L31
E3G-L12/L32

Shown with mounting bracket E39-L139 (included)

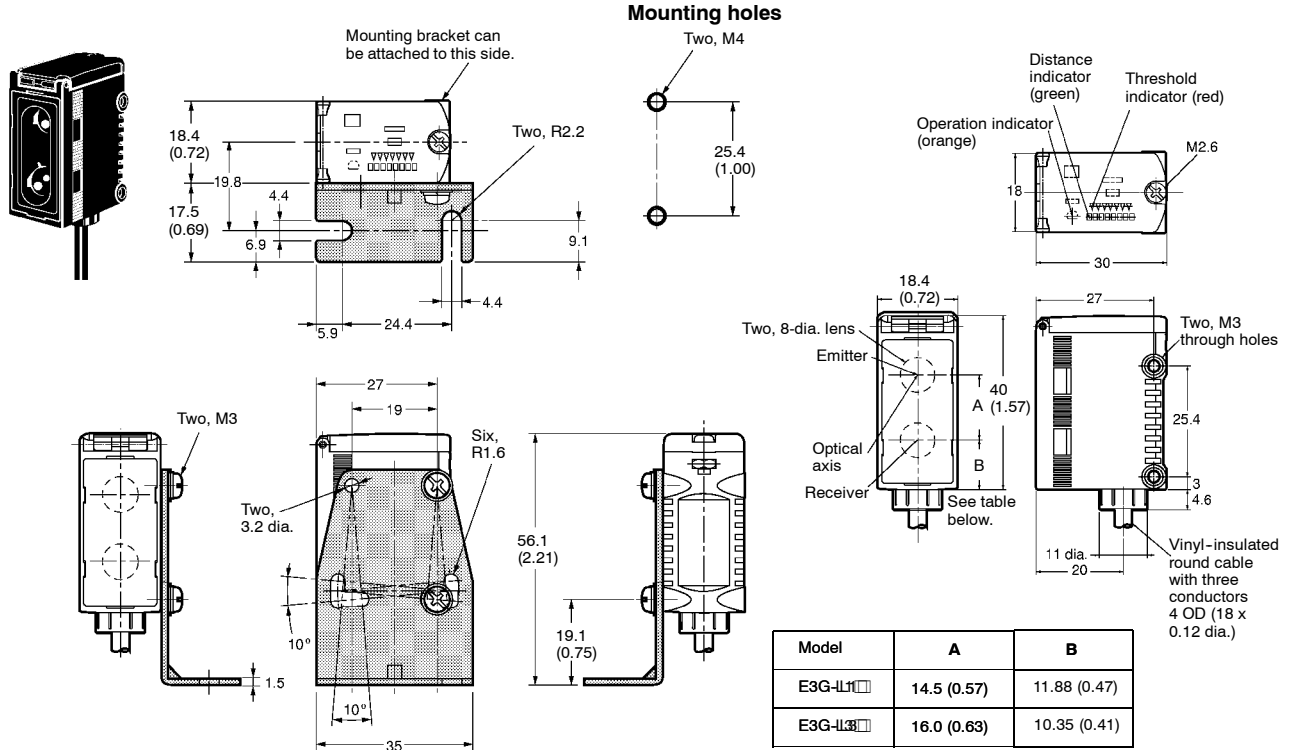

Connector Models

E3G-L15/L35
E3G-L16/L36

Shown with mounting bracket E39-L140 (included)

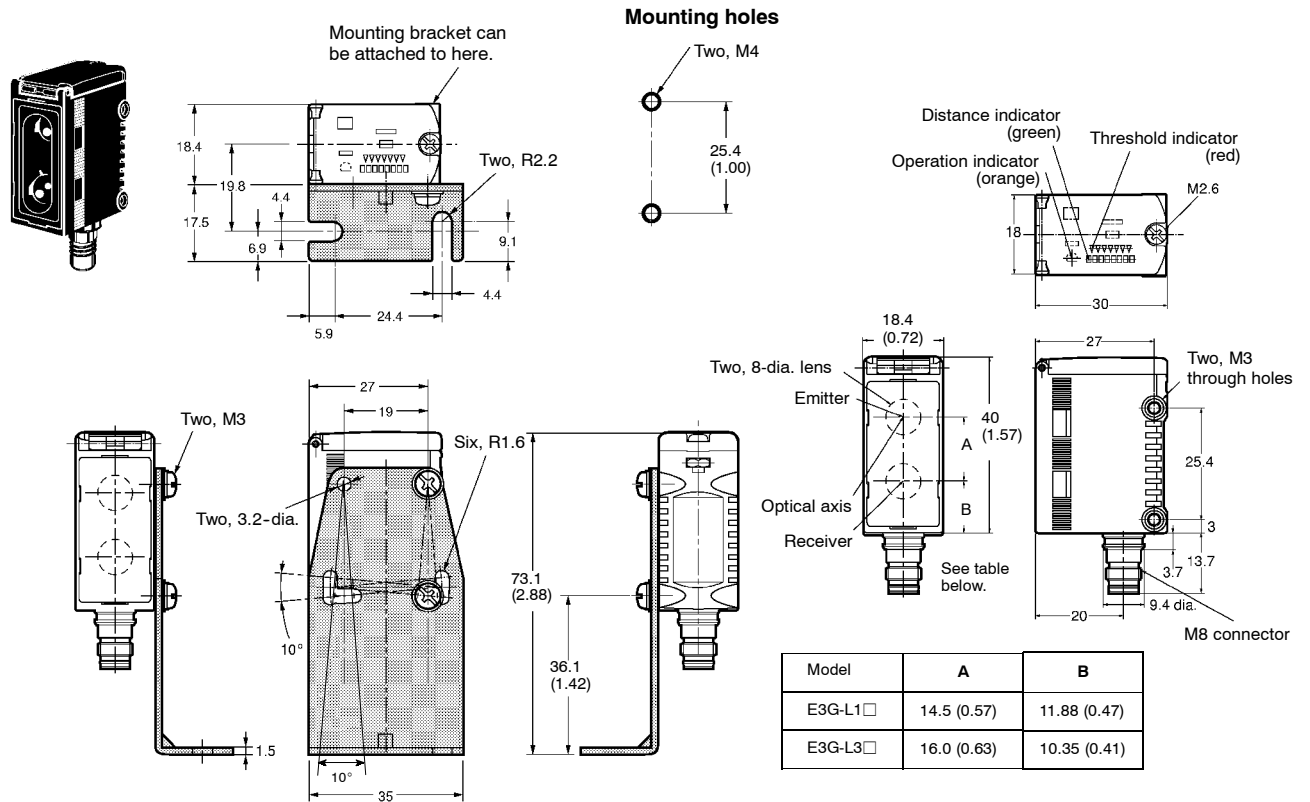

■ MOUNTING BRACKETS

E39-L139

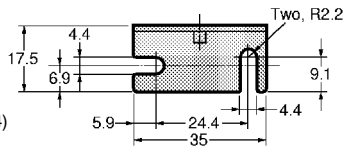
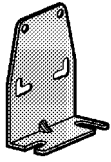

Material: Stainless steel (SUS304)

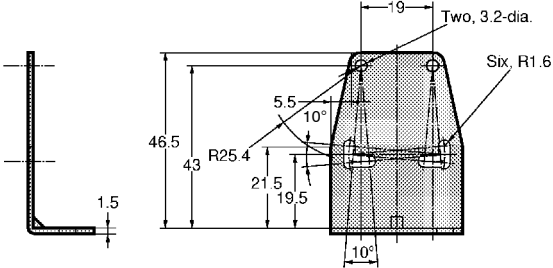

Note: Provided with E3G-L□1/-L□2

E39-L140

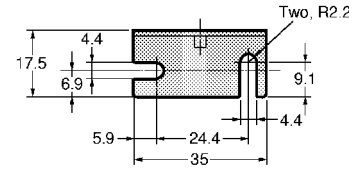
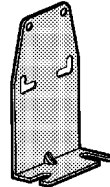

Material: Stainless steel (SUS304)

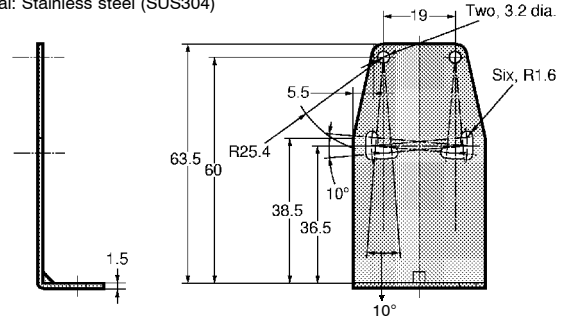

Note: Provided with E3G-L□5/-L□6

■ CONNECTOR CORDSETS

Straight

- XS3F-M421-402-R (L = 2 m)
- XS3F-M421-405-R (L = 5 m)

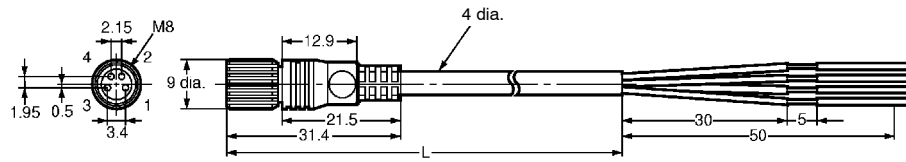
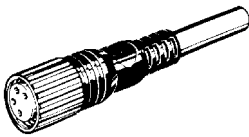

Right Angle

- XS3F-M422-402-R (L = 2 m)
- XS3F-M422-405-R (L = 5 m)

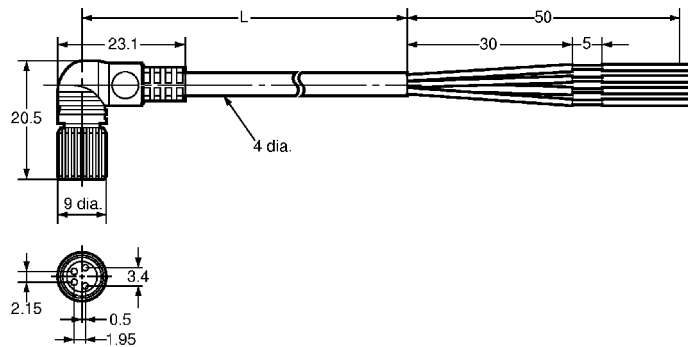
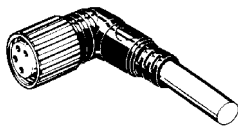

Precautions

■ DESIGNING

High-voltage Lines

Do not place sensor power supply or signal lines within the same conduit as high-voltage power lines.

Voltage Ratings

Do not exceed rated supply voltage, ripple percent (for DC models), or load current limits.

Ambient Lighting

Do not install the sensor in direct sunlight or other sources of strong ambient light.

Environmental Conditions

Do not install the sensor in areas

- With high humidity, or where condensation would result
- With corrosive gas.
- With high vibration or shock.

Power Supply

If a switching power supply is used, or when using an inverter or servomotor, you must ground the FG (frame ground) and G (ground) terminals on the power supply for proper operation and to avoid damaging the sensor.

Water Exposure

Although conforming to IP67, do not use the sensor where it may be immersed, is outdoors, or is exposed to rain.

To ensure the water resistance of the sensor, tighten the screws of the operation panel cover to a torque of 0.2 to 0.3 N • m.

Cable

- The bending radius of the cable should be at least 25 mm.
- When using extended power and signal cable, total length must not exceed 100 m, with a minimum wire size of 0.3 mm² (22 AWG).
- Do not apply tensile force exceeding 50 N to cable (pre-leaded and connector models).

Avoiding Malfunctions

If using the photoelectric sensor with an inverter or servomotor, be sure to ground the FG (frame ground) and G (ground) terminals, otherwise the sensor may malfunction.

Proper Mounting Screws

Use M3 screws and washers to mount the sensor and bracket.

Mechanical Shock

Avoid mechanical shock during installation which may amage the housing (see Shock specifications)

Short-circuit Protection

If the load short-circuits, the output will be turned off. Disconnect power and check the wiring. After correcting the shorted condition, turn power back on. The sensor will reset the short-circuit protection function. The short-circuit protection is activated when the current flow is at least 2.4 times the rated load current. When using an inductive load, the inrush current must not exceed this factor.

Connector

- When connecting or disconnecting the connector, hold the connector cover to avoid tension on the housing.
- Tighten the connector by hand only. Do not use tools which may damage the connector.
- Always disconnect power before connecting or disconnecting the connector.
- Be sure that the connector is tightened securely. The sensor enclosure rating may be reduced or the connector may get loosened.

■ MAINTENANCE AND INSPECTION

Cleaning

- Solvents damage the casing of the sensor. Do not use solvents to clean the sensor.

EEPROM Writing Error

- If a teaching data error occurs with the operation indicator flashing due to a power failure or static noise, perform the teaching operation of the sensor again.

NOTE: DIMENSIONS SHOWN ARE IN MILLIMETERS. To convert millimeters to inches divide by 25.4.

OMRON[®]**OMRON ELECTRONICS LLC**One East Commerce Drive
Schaumburg, IL 60173**1-800-55-OMRON****OMRON ON-LINE**Global - <http://www.omron.com>USA - <http://www.omron.com/oei>Canada - <http://www.omron.com/oci>**OMRON CANADA, INC.**885 Milner Avenue
Scarborough, Ontario M1B 5V8**416-286-6465**