

85969-7 ✓ ACTIVE

AMPMODU | AMPMODU IV/V

TE Internal #: 85969-7

Socket Contact, Gold, 250 VAC, Discrete Wire, 24 – 20 AWG Wire Size, .2 – .6 mm² Wire Size, 394.71 – 1184.12 CMA Wire Size, Crimp, AMPMODU IV/V

[View on TE.com >](#)



Connectors > Contacts > Connector Contacts

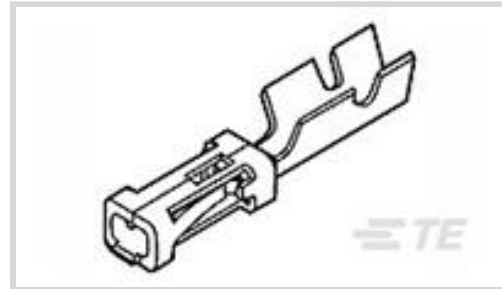

Contact Type: **Socket**

Contact Mating Area Plating Material: **Gold**

Wire Contact Termination Area Plating Material: **Nickel**

Operating Voltage: **250 VAC**

Compatible With Wire & Cable Type: **Discrete Wire**

Features

Product Type Features

Applied Pressure	Standard
------------------	----------

Configuration Features

Compatible With Wire & Cable Type	Discrete Wire
-----------------------------------	---------------

Electrical Characteristics

Termination Resistance	12 mΩ
Insulation Resistance	5000 MΩ
Dielectric Withstanding Voltage (Max)	750 V
Operating Voltage	250 VAC

Contact Features

Mating Square Post Dimension	.64 mm[.025 in]
Contact Type	Socket
Contact Mating Area Plating Material	Gold
Wire Contact Termination Area Plating Material	Nickel
Contact Base Material	Beryllium Copper
Contact Current Rating (Max)	3 A

Termination Features

Termination Method to Wire & Cable	Crimp
Product Terminates To	Wire & Cable



Mechanical Attachment

Wire Insulation Support	With
-------------------------	------

Dimensions

Wire Size	394.71 – 1184.12 CMA
-----------	----------------------

Usage Conditions

Operating Temperature Range	-65 – 105 °C[-85 – 221 °F]
-----------------------------	----------------------------

Operation/Application

Circuit Application	Power & Signal
---------------------	----------------

Industry Standards

Compatible With Approved Standards Products	CSA LR7189, UL E28476
---	-----------------------

Packaging Features

Packaging Quantity	12500
--------------------	-------

Packaging Method	Reel
------------------	------

Product Compliance

[For compliance documentation, visit the product page on TE.com>](#)

EU RoHS Directive 2011/65/EU	Compliant
------------------------------	-----------

EU ELV Directive 2000/53/EC	Compliant
-----------------------------	-----------

China RoHS 2 Directive MIIT Order No 32, 2016	No Restricted Materials Above Threshold
---	---

EU REACH Regulation (EC) No. 1907/2006	Current ECHA Candidate List: JUNE 2024 (241) Candidate List Declared Against: JUNE 2024 (241) Does not contain REACH SVHC
--	---

Halogen Content	Low Halogen - Br, Cl, F, I < 900 ppm per homogenous material. Also BFR/CFR/PVC Free
-----------------	---

Solder Process Capability	Not applicable for solder process capability
---------------------------	--

Product Compliance Disclaimer

This information is provided based on reasonable inquiry of our suppliers and represents our current actual knowledge based on the information they provided. This information is subject to change. The part numbers that TE has identified as EU RoHS compliant have a maximum concentration of 0.1% by weight in homogenous materials for lead, hexavalent chromium, mercury, PBB, PBDE, DBP, BBP, DEHP, DIBP, and 0.01% for cadmium, or qualify for an exemption to these limits as defined in the Annexes of Directive 2011/65/EU (RoHS2). Finished electrical and electronic equipment products will be CE marked as required by Directive 2011/65/EU. Components may not be CE marked. Additionally, the part numbers that TE has identified as EU ELV compliant have a maximum concentration of 0.1% by weight in homogenous materials for lead, hexavalent chromium, and mercury, and 0.01% for cadmium, or qualify for an exemption to these limits as defined in the Annexes of Directive 2000/53/EC (ELV). Regarding the REACH Regulation, the information TE provides

on SVHC in articles for this part number is based on the latest European Chemicals Agency (ECHA) 'Guidance on requirements for substances in articles' posted at this URL: <https://echa.europa.eu/guidance-documents/guidance-on-reach>

Compatible Parts



Also in the Series | AMPMODU IV/V

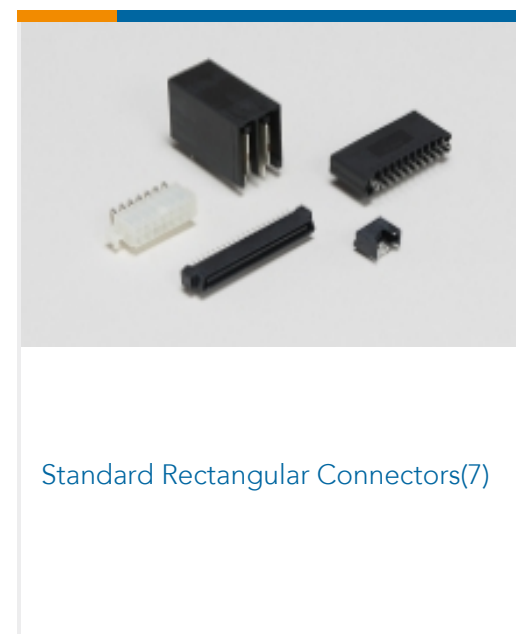
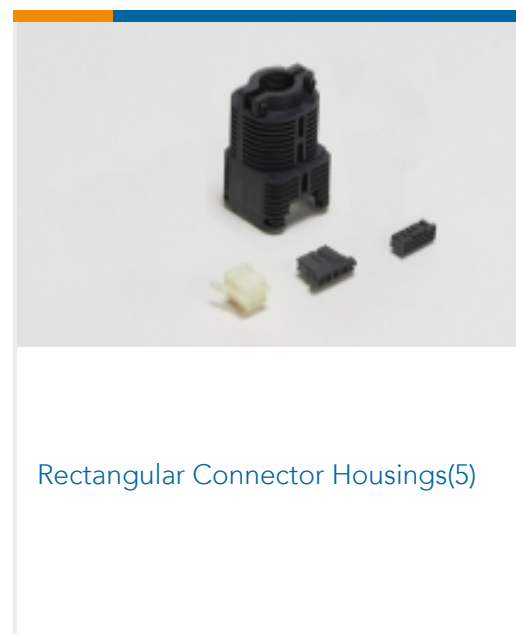
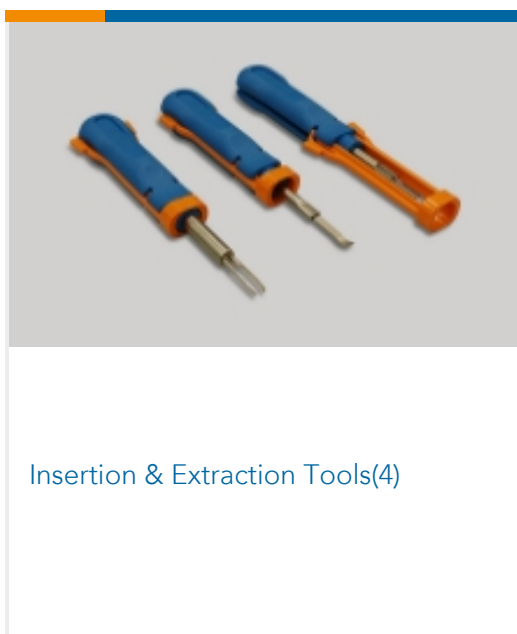
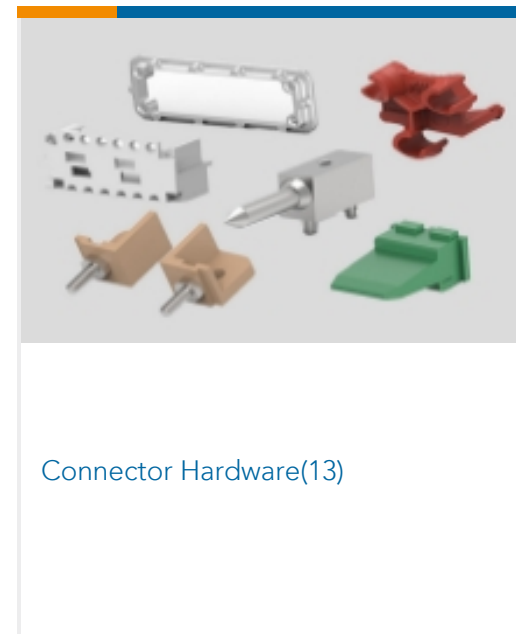
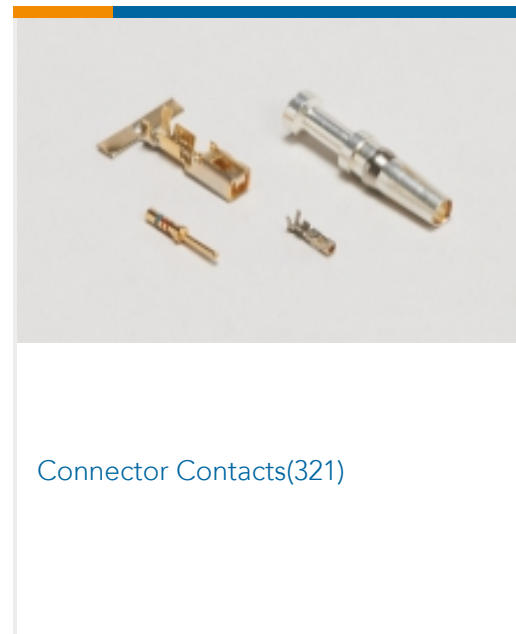
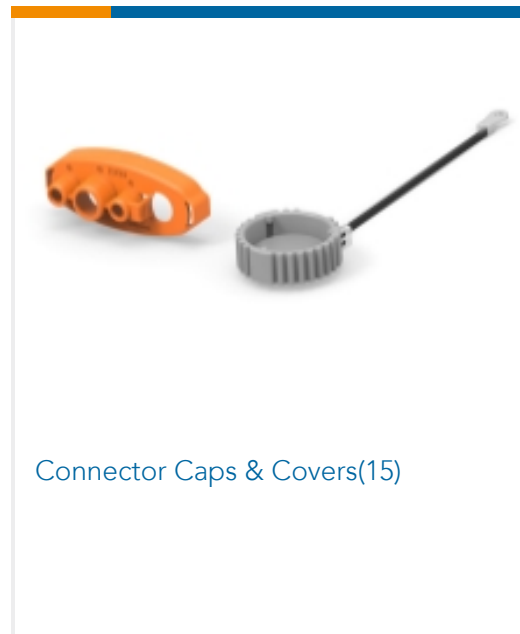
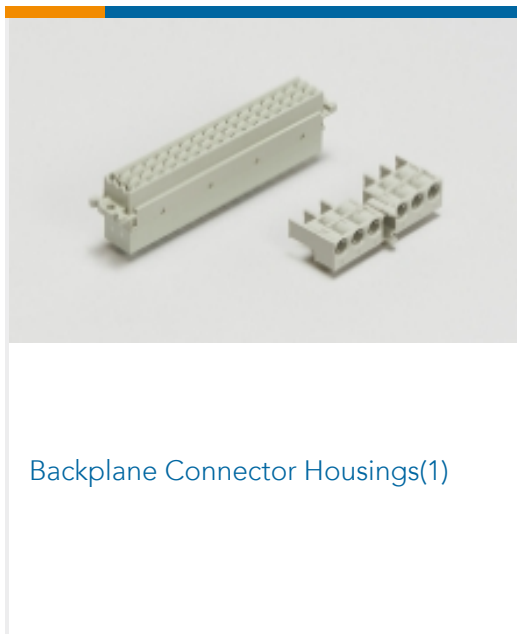



Wire-to-Board Connector Assemblies
& Housings(436)

Customers Also Bought



TE Part #1658651-1
KIT,HDP-20,OVRMLD,RCPT,SIZE 4,

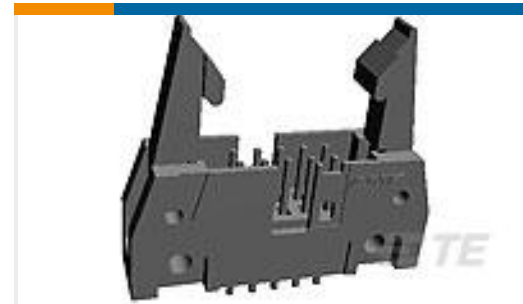

TE Part #1-5499923-2
A/L UNIV HDR 64P VERT LG LAT



TE Part #1625971-7
HSA25 120R 5%



TE Part #1-102387-2
64 MODIV HSG COMP DR .100 POL



TE Part #2-1419108-9
RTD14012F



TE Part #6-2176093-6
RP 2A 0.25W 49K9 0.1% 25PPM 1K RL



TE Part #1-1614959-2
CPF0805 1M6 0.1% 25PPM 1K RL

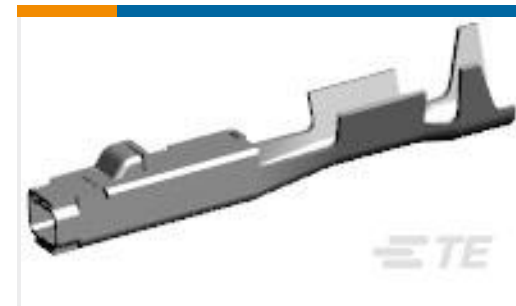

TE Part #1670144-3
MCON 1.2 CB REC SRC AG



TE Part #1924880-1
GET, FEMALE TERMINAL, AGSN, 16

Documents

Product Drawings

[MOD IV RECP PLTD 30 SEL](#)

English

CAD Files

[3D PDF](#)

3D

[Customer View Model](#)

[ENG_CVM_CVM_85969-7_BR.2d_dxf.zip](#)



English

Customer View Model

[ENG_CVM_CVM_85969-7_BR.3d_igs.zip](#)

English

Customer View Model

[ENG_CVM_CVM_85969-7_BR.3d_stp.zip](#)

English

By downloading the CAD file I accept and agree to the [Terms and Conditions](#) of use.

Product Specifications

[Application Specification](#)

English