



UT2306

Power MOSFET

N-CHANNEL ENHANCEMENT MODE

■ DESCRIPTION

The UTC **UT2306** is N-channel power MOSFET, designed with high density cell, with fast switching speed, ultra low on-resistance and excellent thermal and electrical capabilities.

Used in commercial and industrial surface mount applications and suited for low voltage applications such as DC/DC converters.

■ SYMBOL

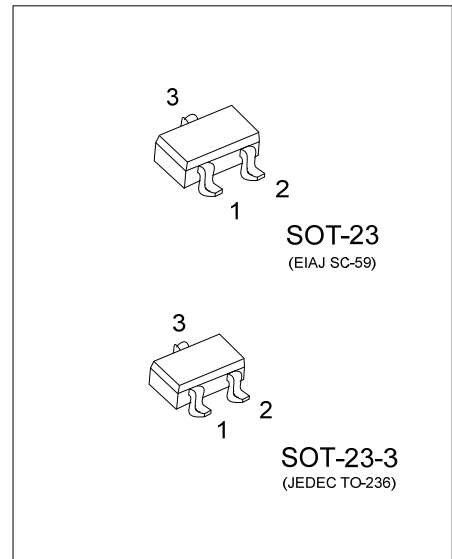
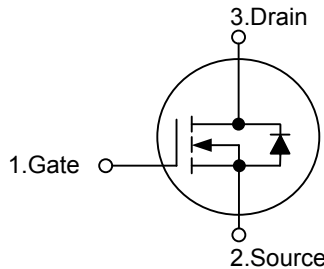

■ ORDERING INFORMATION

Ordering Number		Package	Pin Assignment			Packing
Lead Free	Halogen Free		1	2	3	
UT2306L-AE2-R	UT2306G-AE2-R	SOT-23-3	G	S	D	Tape Reel
UT2306L-AE3-R	UT2306G-AE3-R	SOT-23	G	S	D	Tape Reel

Note: Pin Assignment: G: Gate S: Source D: Drain

<p>UT2306G-AE2-R</p> <p>(1)Packing Type</p> <p>(2)Package Type</p> <p>(3)Green Package</p>	<p>(1) R: Tape Reel</p> <p>(2) AE2: SOT-23-3, AE3: SOT-23</p> <p>(3) G: Halogen Free and Lead Free, L: Lead Free</p>
--	--

■ MARKING

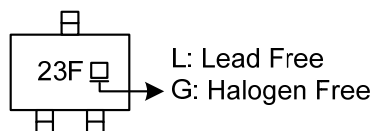

■ ABSOLUTE MAXIMUM RATINGS ($T_A = 25^\circ\text{C}$, unless otherwise specified)

PARAMETER		SYMBOL	RATINGS	UNIT
Drain-Source Voltage		V_{DSS}	30	V
Gate-Source Voltage		V_{GSS}	± 20	V
Continuous Drain Current		I_D	3.5	A
Pulsed Drain Current (Note 1, 2)		I_{DM}	14	A
Avalanche Energy	Single Pulsed (Note 3)	E_{AS}	66	mJ
Power Dissipation	SOT-23-3	P_D	0.5	W
	SOT-23		0.6	W
Junction Temperature		T_J	+150	$^\circ\text{C}$
Storage Temperature		T_{STG}	-55 ~ +150	$^\circ\text{C}$

Notes: 1. Absolute maximum ratings are those values beyond which the device could be permanently damaged.

Absolute maximum ratings are stress ratings only and functional device operation is not implied.

2. Repetitive Rating: Pulse width limited by maximum junction temperature.

3. $L = 0.1\text{mH}$, $I_{AS} = 11.5\text{A}$, $V_{DD} = 100\text{V}$, $R_G = 25\ \Omega$, Starting $T_J = 25^\circ\text{C}$

■ THERMAL DATA

PARAMETER		SYMBOL	RATINGS	UNIT
Junction to Ambient	SOT-23-3	θ_{JA}	250	$^\circ\text{C/W}$
	SOT-23		208	$^\circ\text{C/W}$

Note: Device mounted on FR-4 substrate PC board, 2oz copper, with 1inch square copper plate.

■ ELECTRICAL CHARACTERISTICS ($T_J = 25^\circ\text{C}$, unless otherwise specified)

PARAMETER	SYMBOL	TEST CONDITIONS	MIN	TYP	MAX	UNIT
OFF CHARACTERISTICS						
Drain-Source Breakdown Voltage	BV_{DSS}	$V_{GS}=0\text{ V}$, $I_D=250\ \mu\text{A}$	30			V
Drain-Source Leakage Current	I_{DSS}	$V_{DS}=24\text{ V}$, $V_{GS}=0\text{ V}$			1	μA
Gate-Source Leakage Current	I_{GSS}	$V_{GS}=\pm 20\text{ V}$, $V_{DS}=0\text{ V}$			100	nA
ON CHARACTERISTICS						
Gate Threshold Voltage	$V_{GS(TH)}$	$V_{DS}=V_{GS}$, $I_D=250\ \mu\text{A}$	1.0		2.0	V
Static Drain-Source On-Resistance	$R_{DS(ON)}$	$V_{GS}=10\text{ V}$, $I_D=3.6\text{ A}$			65	m Ω
		$V_{GS}=4.5\text{ V}$, $I_D=2.8\text{ A}$			90	m Ω
DYNAMIC PARAMETERS						
Input Capacitance	C_{ISS}	$V_{DS}=15\text{V}$, $V_{GS}=0\text{ V}$, $f=1\text{MHz}$		145		pF
Output Capacitance	C_{OSS}			43		pF
Reverse Transfer Capacitance	C_{RSS}			35		pF
SWITCHING PARAMETERS						
Total Gate Charge	Q_G	$V_{DS}=24\text{V}$, $V_{GS}=10\text{V}$, $I_D=3.6\text{A}$ (Note 1, 2)		9.7		nC
Gate Source Charge	Q_{GS}			1.5		nC
Gate Drain Charge	Q_{GD}			0.7		nC
Turn-ON Delay Time	$t_{D(ON)}$	$V_{DS}=15\text{V}$, $V_{GS}=10\text{V}$, $I_D=3.6\text{A}$ $R_G=3\ \Omega$ (Note 1, 2)		4		ns
Turn-ON Rise Time	t_R			14		ns
Turn-OFF Delay Time	$t_{D(OFF)}$			6		ns
Turn-OFF Fall-Time	t_F			18		ns
SOURCE- DRAIN DIODE RATINGS AND CHARACTERISTICS						
Maximum Body-Diode Continuous Current	I_S				3.6	A
Maximum Body-Diode Pulsed Current	I_{SM}				14	A
Drain-Source Diode Forward Voltage	V_{SD}	$I_S=1.0\text{A}$			1.0	V

Notes: 1. Pulse Test: Pulse width $\leq 300\ \mu\text{s}$, Duty cycle $\leq 2\%$.

2. Essentially independent of operating temperature.

■ TYPICAL CHARACTERISTICS

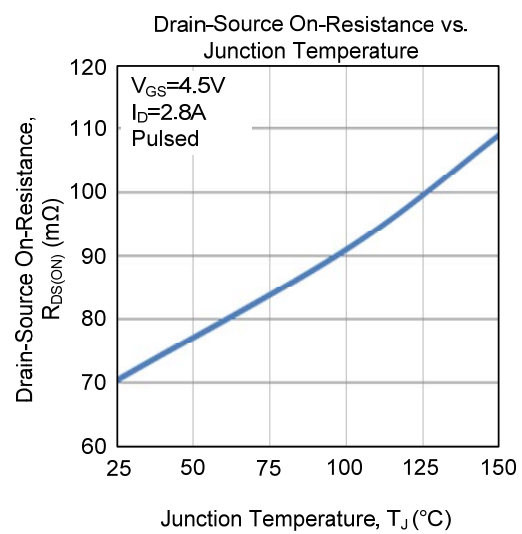
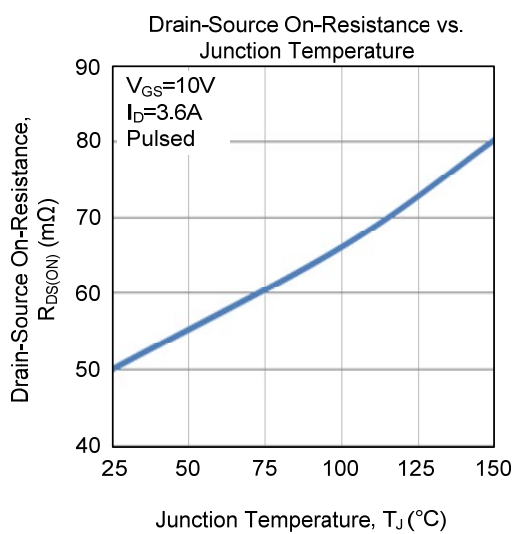
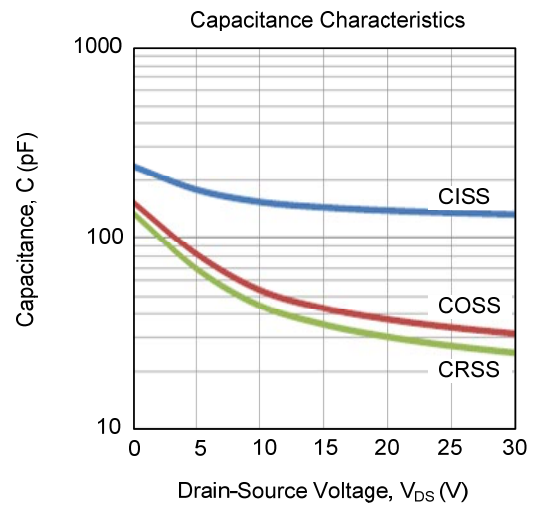
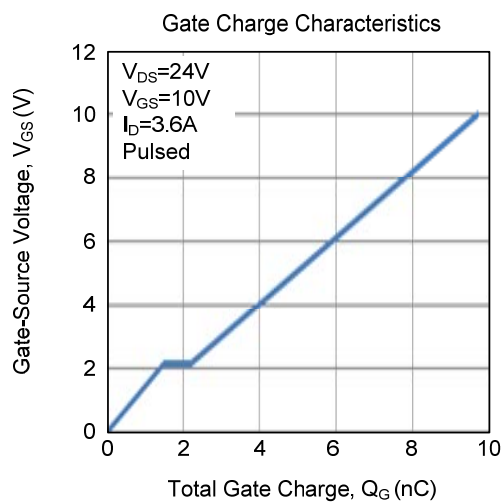
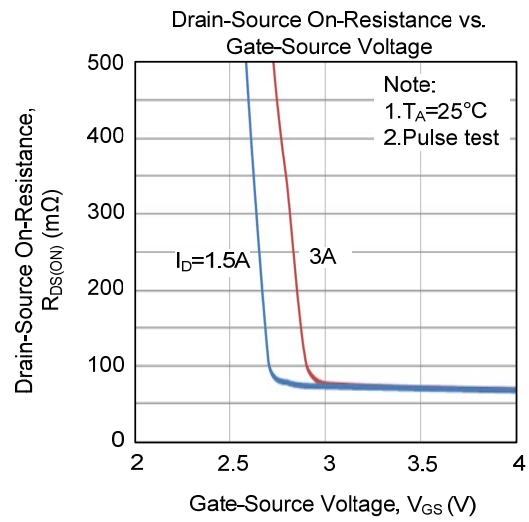
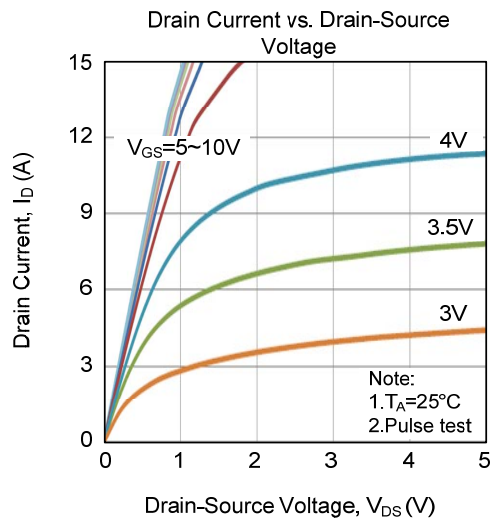

■ TYPICAL CHARACTERISTICS (Cont.)

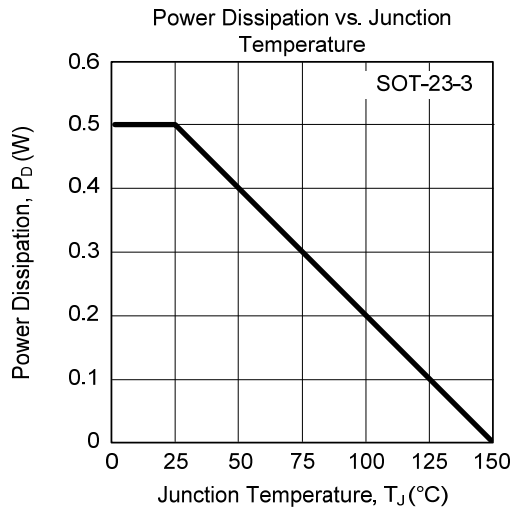
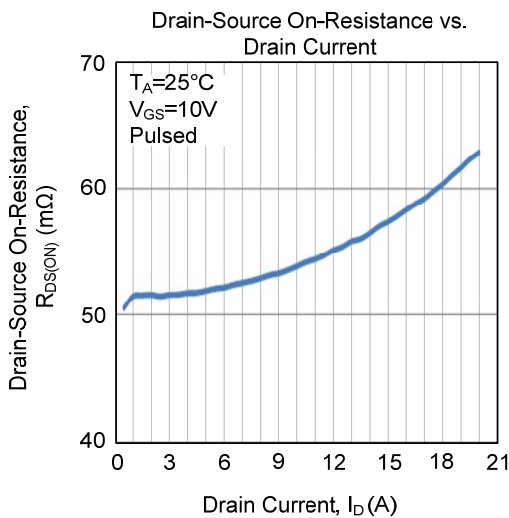
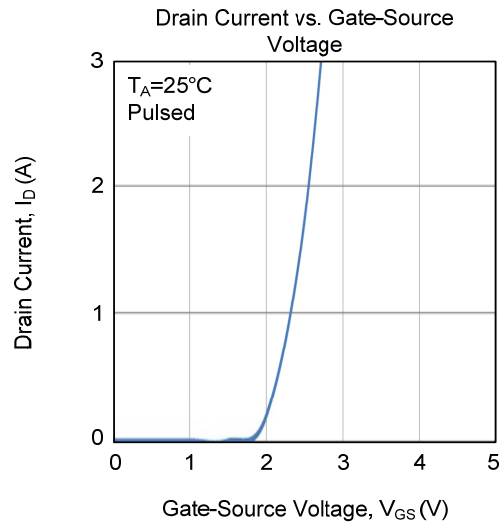
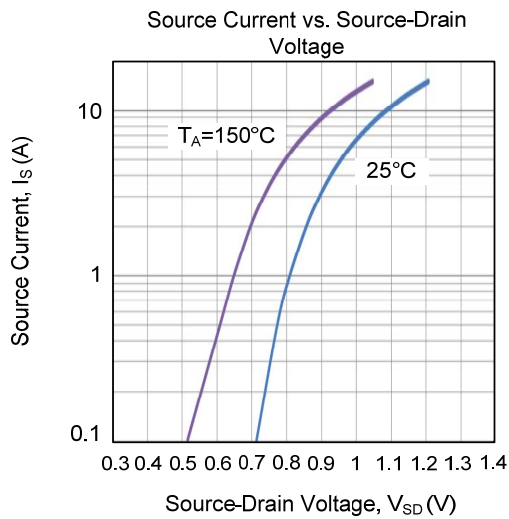
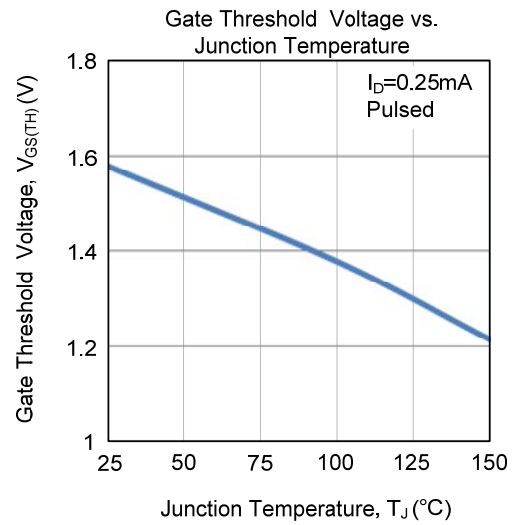
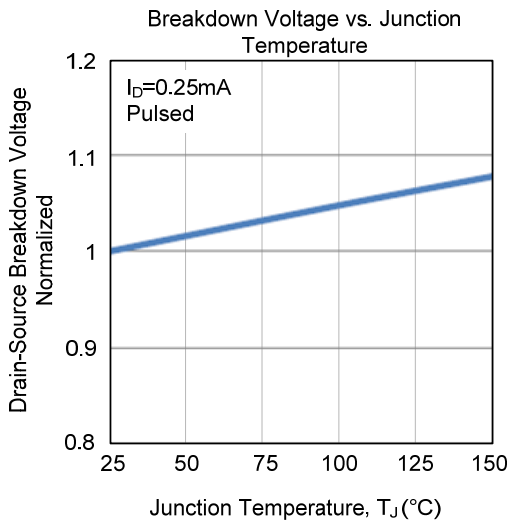

■ TYPICAL CHARACTERISTICS (Cont.)

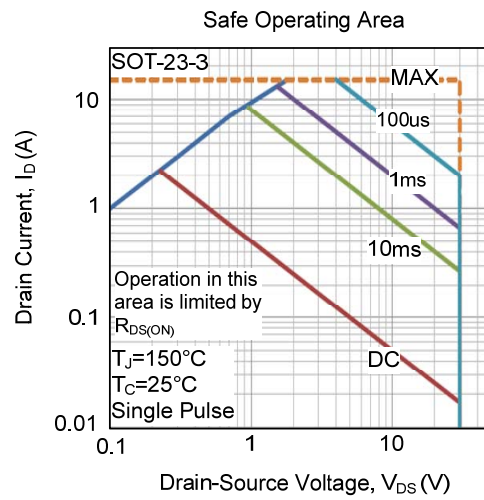
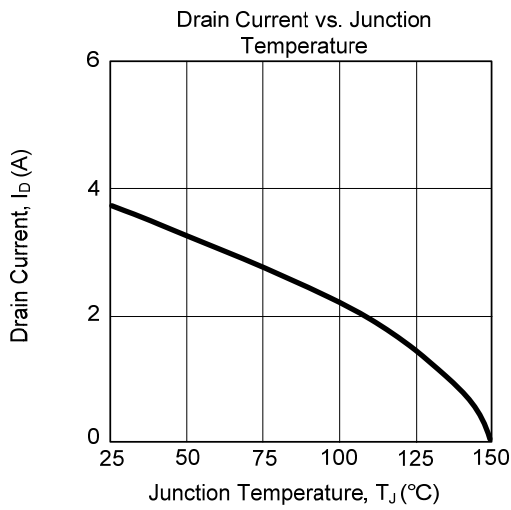

UTC assumes no responsibility for equipment failures that result from using products at values that exceed, even momentarily, rated values (such as maximum ratings, operating condition ranges, or other parameters) listed in products specifications of any and all UTC products described or contained herein. UTC products are not designed for use in life support appliances, devices or systems where malfunction of these products can be reasonably expected to result in personal injury. Reproduction in whole or in part is prohibited without the prior written consent of the copyright owner. UTC reserves the right to make changes to information published in this document, including without limitation specifications and product descriptions, at any time and without notice. This document supersedes and replaces all information supplied prior to the publication hereof.