

CSD85301Q2 20 V Dual N-Channel NexFET™ Power MOSFETs

1 Features

- Low On-Resistance
- Dual Independent MOSFETs
- Space Saving SON 2 x 2 mm Plastic Package
- Optimized for 5 V Gate Driver
- Avalanche Rated
- Pb and Halogen Free
- RoHS Compliant

2 Applications

- Point-of-Load Synchronous Buck Converter for Applications in Networking, Telecom, and Computing Systems
- Adaptor or USB Input Protection for Notebook PCs and Tablets
- Battery Protection

3 Description

The CSD85301Q2 is a 20 V, 23 mΩ N-Channel device with dual independent MOSFETs in a SON 2 x 2 mm plastic package. The two FETs were designed to be used in a half bridge configuration for synchronous buck and other power supply applications. Additionally, this part can be used for adaptor, USB input protection and battery charging applications. The dual FETs feature low drain to source on-resistance that minimizes losses and offers low component count for space constrained applications.

Top View and Circuit Image

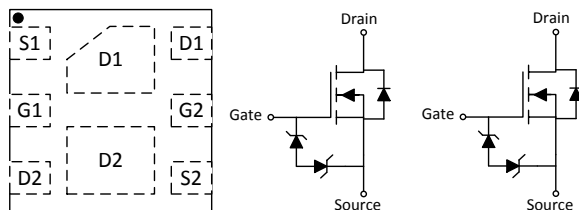

$R_{DS(on)}$ vs V_{GS}

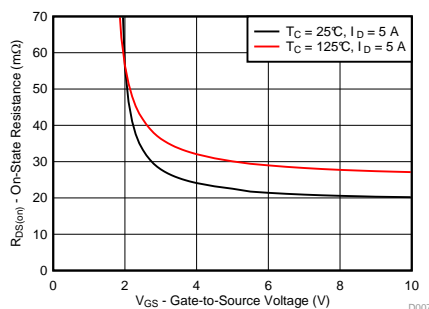

Product Summary

$T_A = 25^\circ\text{C}$		TYPICAL VALUE		UNIT
V_{DS}	Drain-to-Source Voltage	20		V
Q_g	Gate Charge Total (4.5 V)	4.2		nC
Q_{gd}	Gate Charge Gate to Drain	1.0		nC
$R_{DS(on)}$	Drain-to-Source On Resistance	$V_{GS} = 1.8\text{ V}$	65	mΩ
		$V_{GS} = 2.5\text{ V}$	33	mΩ
		$V_{GS} = 3.8\text{ V}$	25	mΩ
		$V_{GS} = 4.5\text{ V}$	23	mΩ
$V_{GS(th)}$	Threshold Voltage	0.9		V

Ordering Information⁽¹⁾

Device	Media	Qty	Package	Ship
CSD85301Q2	7-Inch Reel	3000	SON 2 x 2 mm Plastic Package	Tape and Reel
CSD85301Q2T	7-Inch Reel	250		

(1) For all available packages, see the orderable addendum at the end of the data sheet.

Absolute Maximum Ratings

$T_A = 25^\circ\text{C}$		VALUE	UNIT
V_{DS}	Drain-to-Source Voltage	20	V
V_{GS}	Gate-to-Source Voltage	±10	V
I_D	Continuous Drain Current (Package limited)	5.0	A
I_{DM}	Pulsed Drain Current ⁽¹⁾	26	A
P_D	Power Dissipation ⁽²⁾	2.3	W
T_J, T_{stg}	Operating Junction and Storage Temperature Range	-55 to 150	°C
E_{AS}	Avalanche Energy, single pulse $I_D = 8.7\text{ A}, L = 0.1\text{ mH}, R_G = 25\ \Omega$	3.8	mJ

(1) Max $R_{\theta JA} = 185\ \text{°C/W}$, pulse duration $\leq 100\ \mu\text{s}$, duty cycle $\leq 1\%$.

(2) Typical $R_{\theta JA} = 55\ \text{°C/W}$ on a 1 inch², 2 oz. Cu pad on a 0.06 inch thick FR4 PCB.

Gate Charge

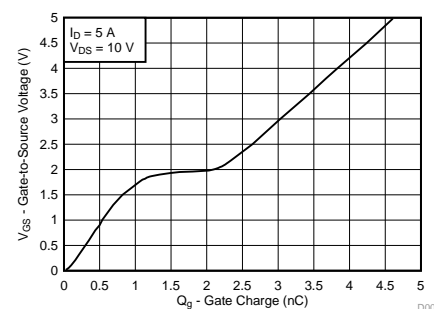

Table of Contents

1 Features	1	6.1 Trademarks	7
2 Applications	1	6.2 Electrostatic Discharge Caution	7
3 Description	1	6.3 Glossary	7
4 Revision History	2	7 Mechanical, Packaging, and Orderable Information	8
5 Specifications	3	7.1 Package Dimensions	8
5.1 Electrical Characteristics	3	7.2 PCB Land Pattern	9
5.2 Thermal Information	3	7.3 Recommended Stencil Opening	9
5.3 Typical MOSFET Characteristics	4	7.4 Q2 Tape and Reel Information	10
6 Device and Documentation Support	7		

4 Revision History

DATE	REVISION	NOTES
December 2014	*	Initial release.

5 Specifications

5.1 Electrical Characteristics

(T_A = 25°C unless otherwise stated)

PARAMETER		TEST CONDITIONS	MIN	TYP	MAX	UNIT
STATIC CHARACTERISTICS						
V _{DSS}	Drain-to-Source Voltage	V _{GS} = 0 V, I _D = 250 μA	20			V
I _{DSS}	Drain-to-Source Leakage Current	V _{GS} = 0 V, V _{DS} = 16 V			1	μA
I _{GSS}	Gate-to-Source Leakage Current	V _{DS} = 0 V, V _{GS} = 10 V			10	μA
V _{GS(th)}	Gate-to-Source Threshold Voltage	V _{DS} = V _{GS} , I _D = 250 μA	0.6	0.9	1.2	V
R _{DS(on)}	Drain-to-Source On-Resistance	V _{GS} = 1.8 V, I _D = 0.5 A		65	99	mΩ
		V _{GS} = 2.5 V, I _D = 5 A		33	39	mΩ
		V _{GS} = 3.8 V, I _D = 5 A		25	29	mΩ
		V _{GS} = 4.5 V, I _D = 5 A		23	27	mΩ
g _{fs}	Transconductance	V _{DS} = 2 V, I _D = 5 A		20		S
DYNAMIC CHARACTERISTICS						
C _{iss}	Input Capacitance	V _{GS} = 0 V, V _{DS} = 10 V, f = 1 MHz		361	469	pF
C _{oss}	Output Capacitance			68	89	pF
C _{rss}	Reverse Transfer Capacitance			48	62	pF
R _G	Series Gate Resistance			7.3		Ω
Q _g	Gate Charge Total (4.5 V)	V _{DS} = 10 V, I _D = 5 A		4.2	5.4	nC
Q _{gd}	Gate Charge Gate-to-Drain			1.0		nC
Q _{gs}	Gate Charge Gate-to-Source			1.1		nC
Q _{g(th)}	Gate Charge at V _{th}			0.5		nC
Q _{oss}	Output Charge	V _{DS} = 10 V, V _{GS} = 0 V		1.3		nC
t _{d(on)}	Turn On Delay Time	V _{DS} = 10 V, V _{GS} = 5 V, I _{DS} = 5 A, R _G = 0 Ω		6		ns
t _r	Rise Time			26		ns
t _{d(off)}	Turn Off Delay Time			14		ns
t _f	Fall Time			15		ns
DIODE CHARACTERISTICS						
V _{SD}	Diode Forward Voltage	I _{SD} = 5 A, V _{GS} = 0 V		0.8	1.0	V
Q _{rr}	Reverse Recovery Charge	V _{DS} = 10 V, I _F = 5 A, di/dt = 300 A/μs		7.2		nC
t _{rr}	Reverse Recovery Time			14		ns

5.2 Thermal Information

(T_A = 25°C unless otherwise stated)

THERMAL METRIC		MIN	TYP	MAX	UNIT
R _{θJA}	Junction-to-Ambient Thermal Resistance ⁽¹⁾			70	°C/W
	Junction-to-Ambient Thermal Resistance ⁽²⁾			185	

(1) Device mounted on FR4 material with 1 inch² (6.45 cm²), 2 oz. (0.071 mm thick) Cu.

(2) Device mounted on FR4 material with minimum Cu mounting area.

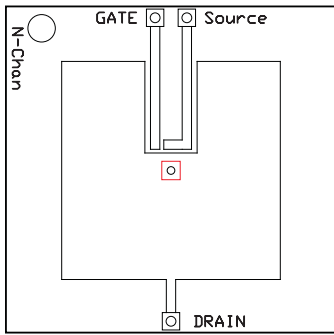

M0164-01

Max $R_{\theta JA} = 70$ when mounted on 1 inch² (6.45 cm²) of 2 oz. (0.071 mm thick) Cu.

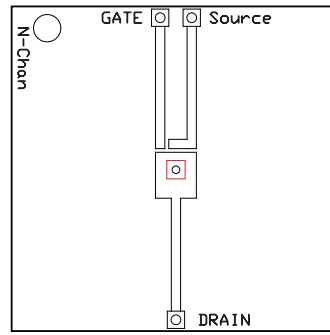

M0164-02

Max $R_{\theta JA} = 185$ when mounted on minimum pad area of 2 oz. (0.071 mm thick) Cu.

5.3 Typical MOSFET Characteristics

($T_A = 25^\circ\text{C}$ unless otherwise stated)

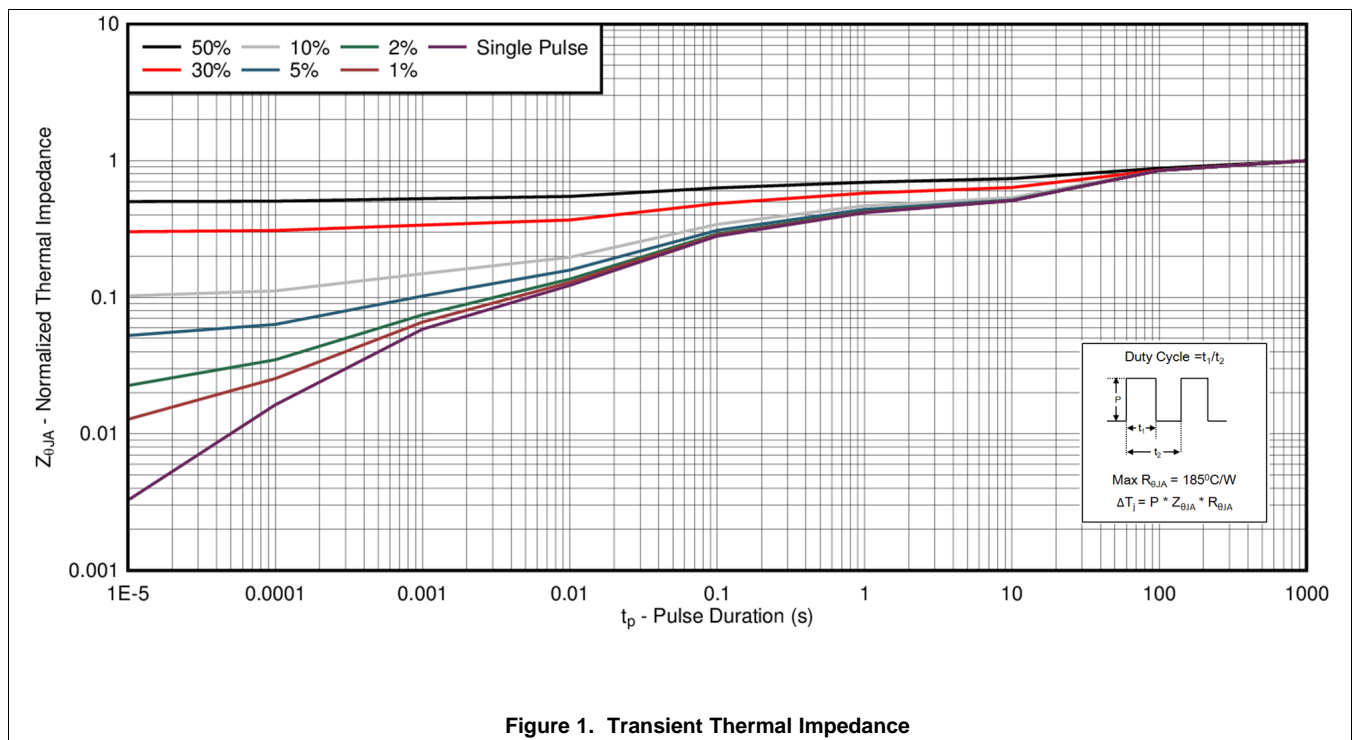

Figure 1. Transient Thermal Impedance

Typical MOSFET Characteristics (continued)

($T_A = 25^\circ\text{C}$ unless otherwise stated)

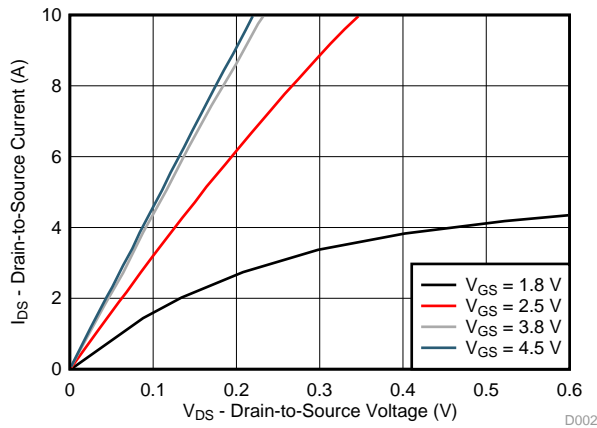

Figure 2. Saturation Characteristics

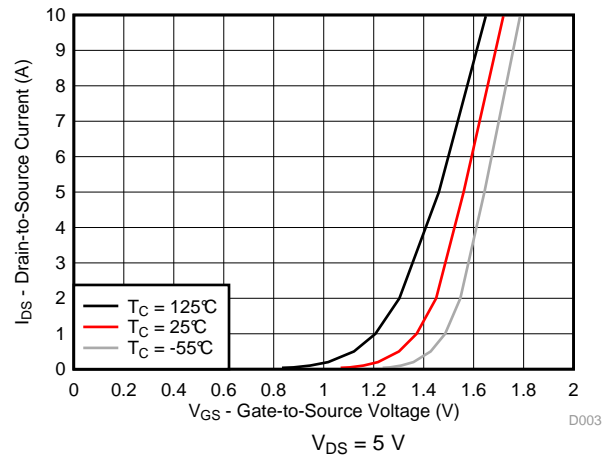

Figure 3. Transfer Characteristics

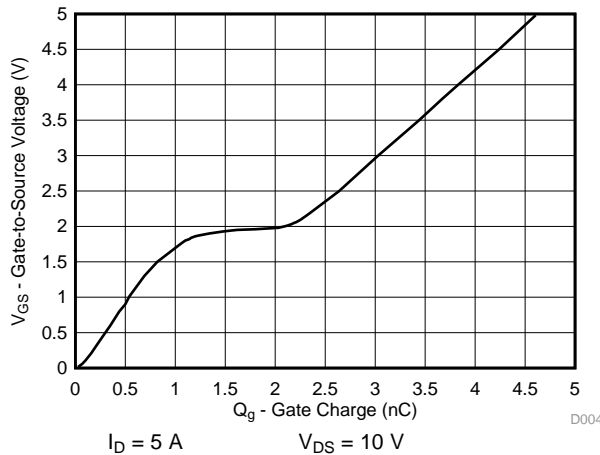

Figure 4. Gate Charge

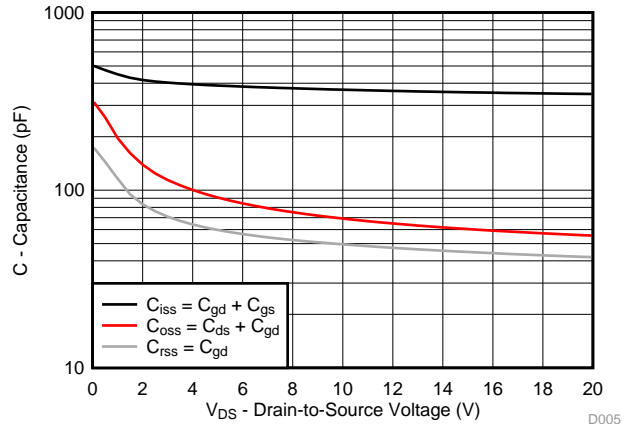

Figure 5. Capacitance

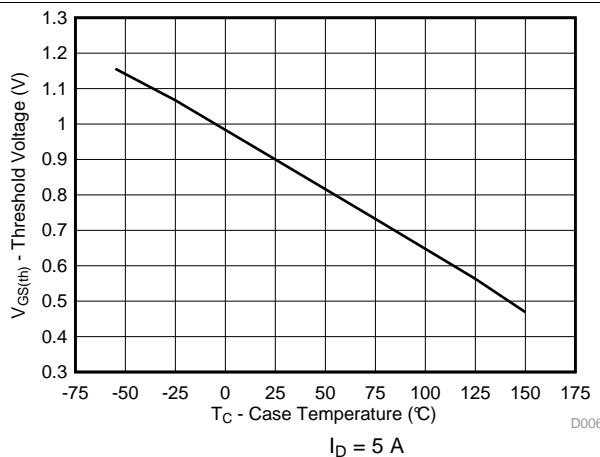

Figure 6. Threshold Voltage vs Temperature

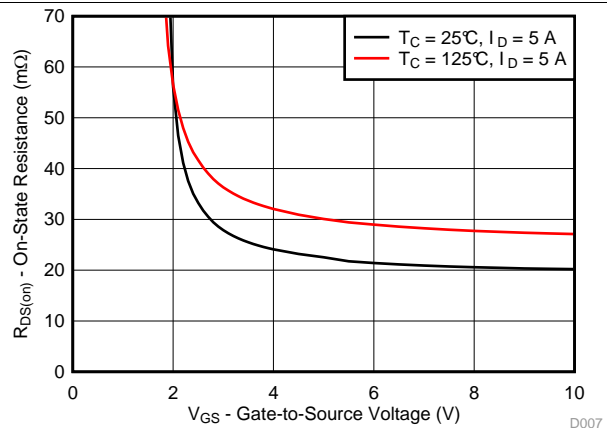

Figure 7. On-State Resistance vs Gate-to-Source Voltage

Typical MOSFET Characteristics (continued)

($T_A = 25^\circ\text{C}$ unless otherwise stated)

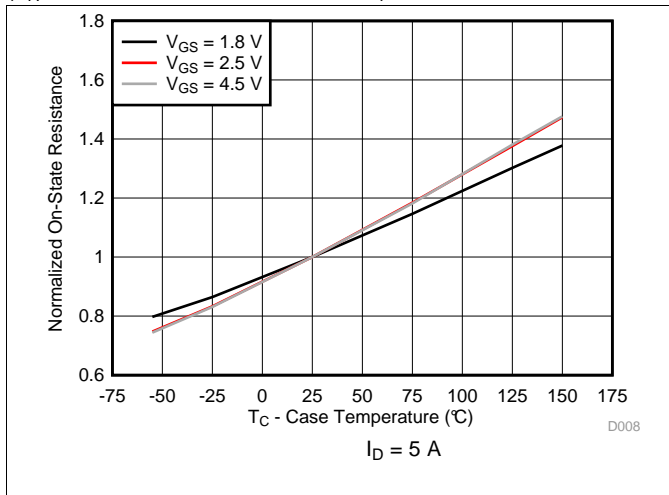

Figure 8. Normalized On-State Resistance vs Temperature

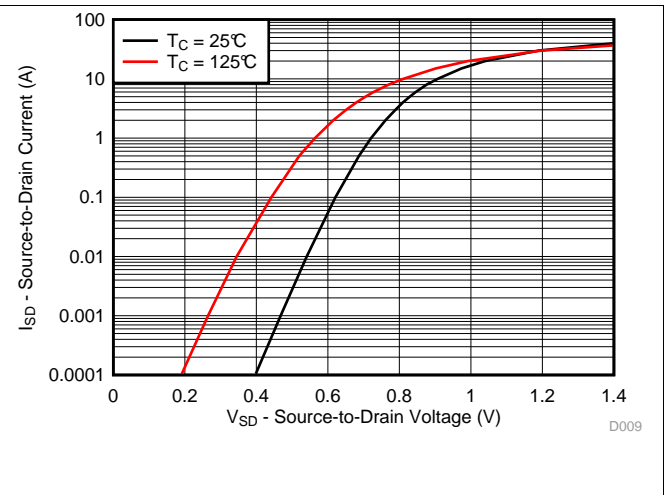

Figure 9. Typical Diode Forward Voltage

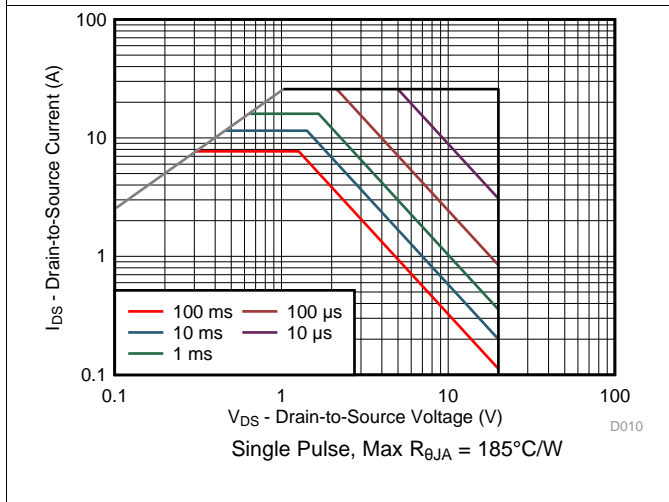

Figure 10. Maximum Safe Operating Area

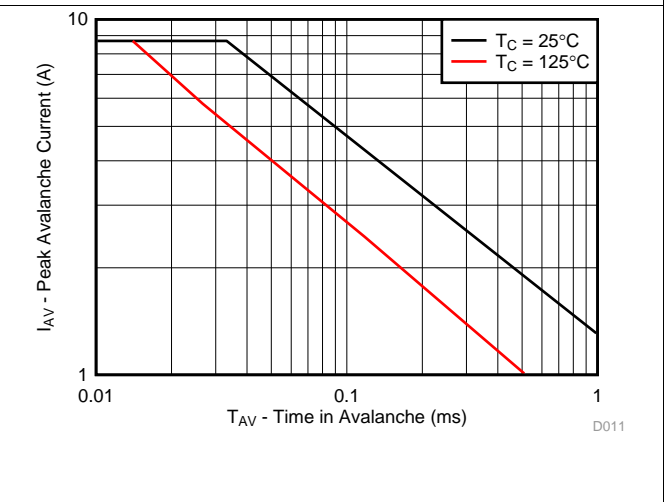

Figure 11. Single Pulse Unclamped Inductive Switching

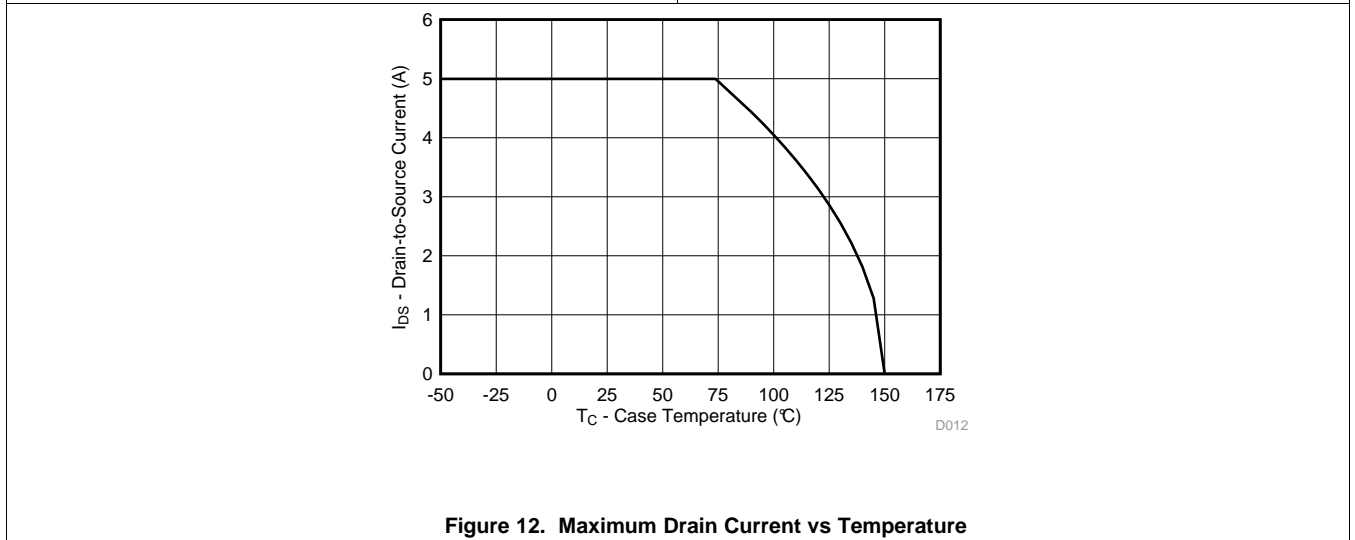

Figure 12. Maximum Drain Current vs Temperature

6 Device and Documentation Support

6.1 Trademarks

NexFET is a trademark of Texas Instruments.
All other trademarks are the property of their respective owners.

6.2 Electrostatic Discharge Caution



These devices have limited built-in ESD protection. The leads should be shorted together or the device placed in conductive foam during storage or handling to prevent electrostatic damage to the MOS gates.

6.3 Glossary

[SLYZ022](#) — *TI Glossary*.

This glossary lists and explains terms, acronyms, and definitions.

7 Mechanical, Packaging, and Orderable Information

The following pages include mechanical, packaging, and orderable information. This information is the most current data available for the designated devices. This data is subject to change without notice and revision of this document. For browser-based versions of this data sheet, refer to the left-hand navigation.

7.1 Package Dimensions

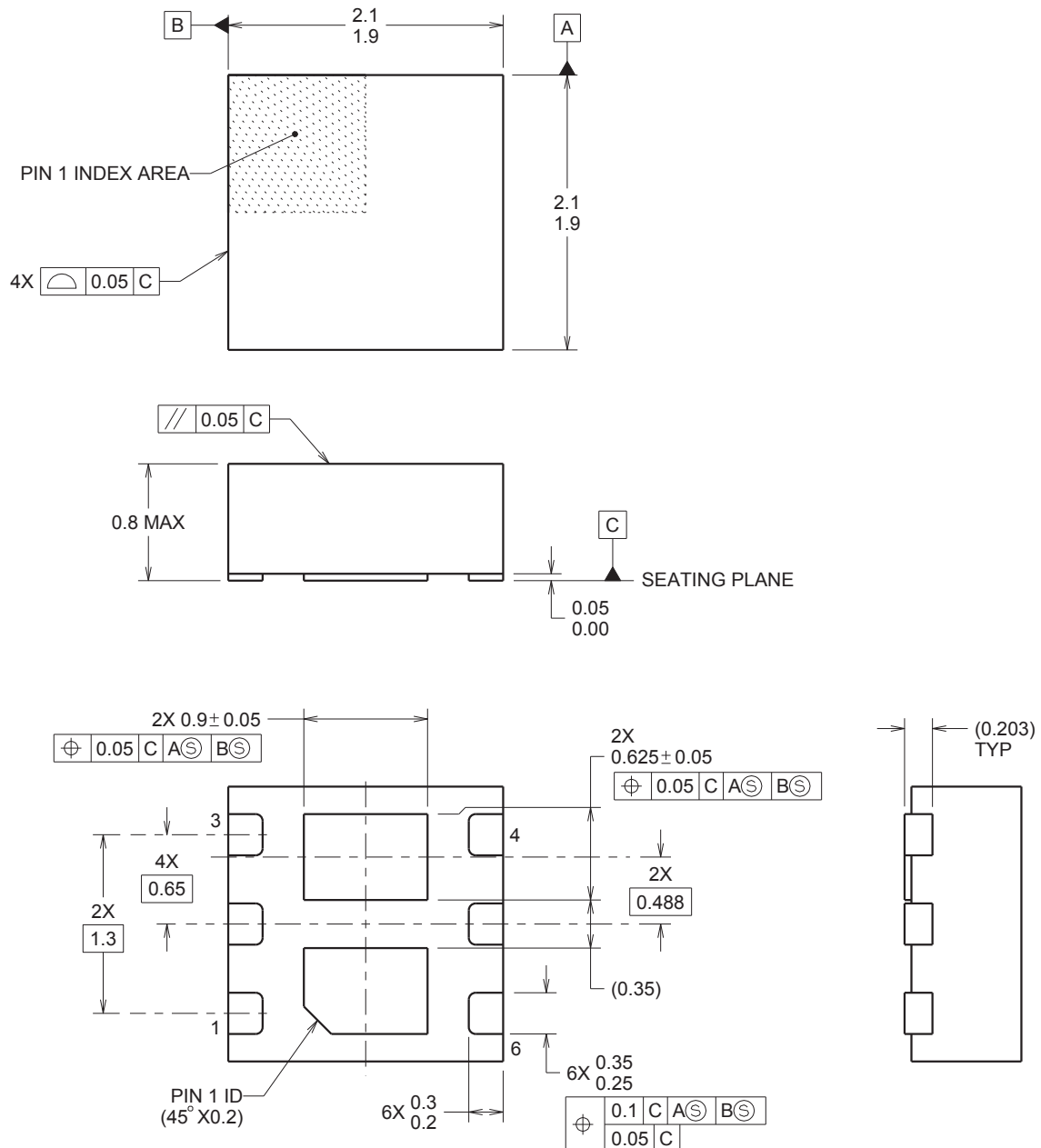

All dimensions are in mm, unless otherwise stated.

7.2 PCB Land Pattern

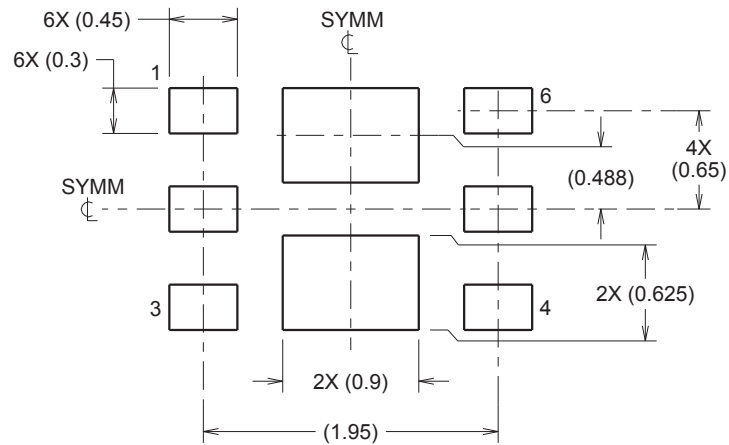

For recommended circuit layout for PCB designs, see application note [SLPA005 – Reducing Ringing Through PCB Layout Techniques](#).

7.3 Recommended Stencil Opening

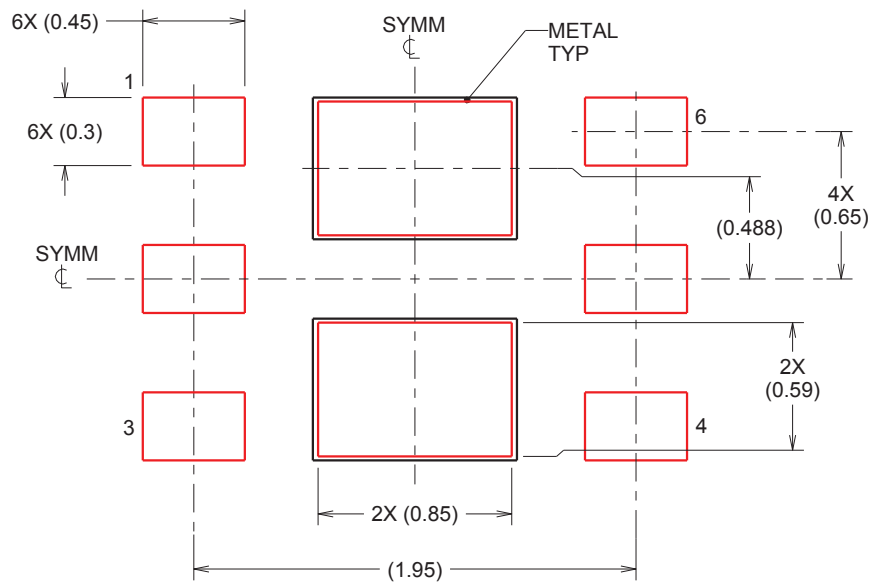

All dimensions are in mm, unless otherwise stated.

7.4 Q2 Tape and Reel Information

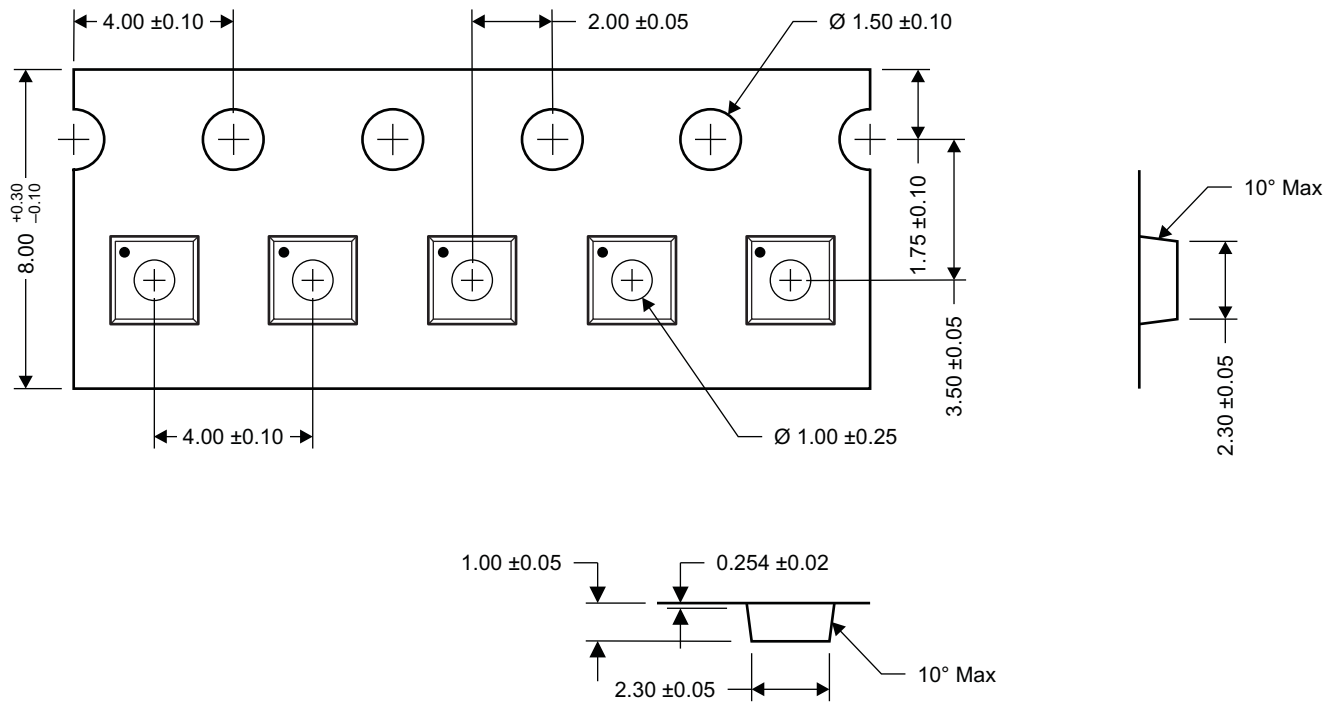

- Notes:
1. Measured from centerline of sprocket hole to centerline of pocket
 2. Cumulative tolerance of 10 sprocket holes is ± 0.20
 3. Other material available
 4. Typical SR of form tape Max 10^9 OHM/SQ
 5. All dimensions are in mm, unless otherwise specified.

M0168-01

PACKAGING INFORMATION

Orderable Device	Status (1)	Package Type	Package Drawing	Pins	Package Qty	Eco Plan (2)	Lead/Ball Finish (6)	MSL Peak Temp (3)	Op Temp (°C)	Device Marking (4/5)	Samples
CSD85301Q2	ACTIVE	WSON	DQK	6	3000	Green (RoHS & no Sb/Br)	CU NIPDAU CU SN	Level-1-260C-UNLIM		8531	Samples
CSD85301Q2T	ACTIVE	WSON	DQK	6	250	Green (RoHS & no Sb/Br)	CU NIPDAU CU SN	Level-1-260C-UNLIM	-55 to 150	8531	Samples

(1) The marketing status values are defined as follows:

ACTIVE: Product device recommended for new designs.

LIFEBUY: TI has announced that the device will be discontinued, and a lifetime-buy period is in effect.

NRND: Not recommended for new designs. Device is in production to support existing customers, but TI does not recommend using this part in a new design.

PREVIEW: Device has been announced but is not in production. Samples may or may not be available.

OBSOLETE: TI has discontinued the production of the device.

(2) **RoHS:** TI defines "RoHS" to mean semiconductor products that are compliant with the current EU RoHS requirements for all 10 RoHS substances, including the requirement that RoHS substance do not exceed 0.1% by weight in homogeneous materials. Where designed to be soldered at high temperatures, "RoHS" products are suitable for use in specified lead-free processes. TI may reference these types of products as "Pb-Free".

RoHS Exempt: TI defines "RoHS Exempt" to mean products that contain lead but are compliant with EU RoHS pursuant to a specific EU RoHS exemption.

Green: TI defines "Green" to mean the content of Chlorine (Cl) and Bromine (Br) based flame retardants meet JS709B low halogen requirements of <=1000ppm threshold. Antimony trioxide based flame retardants must also meet the <=1000ppm threshold requirement.

(3) MSL, Peak Temp. - The Moisture Sensitivity Level rating according to the JEDEC industry standard classifications, and peak solder temperature.

(4) There may be additional marking, which relates to the logo, the lot trace code information, or the environmental category on the device.

(5) Multiple Device Markings will be inside parentheses. Only one Device Marking contained in parentheses and separated by a "-" will appear on a device. If a line is indented then it is a continuation of the previous line and the two combined represent the entire Device Marking for that device.

(6) Lead/Ball Finish - Orderable Devices may have multiple material finish options. Finish options are separated by a vertical ruled line. Lead/Ball Finish values may wrap to two lines if the finish value exceeds the maximum column width.

Important Information and Disclaimer:The information provided on this page represents TI's knowledge and belief as of the date that it is provided. TI bases its knowledge and belief on information provided by third parties, and makes no representation or warranty as to the accuracy of such information. Efforts are underway to better integrate information from third parties. TI has taken and continues to take reasonable steps to provide representative and accurate information but may not have conducted destructive testing or chemical analysis on incoming materials and chemicals. TI and TI suppliers consider certain information to be proprietary, and thus CAS numbers and other limited information may not be available for release.

In no event shall TI's liability arising out of such information exceed the total purchase price of the TI part(s) at issue in this document sold by TI to Customer on an annual basis.

TAPE AND REEL INFORMATION

QUADRANT ASSIGNMENTS FOR PIN 1 ORIENTATION IN TAPE

*All dimensions are nominal

Device	Package Type	Package Drawing	Pins	SPQ	Reel Diameter (mm)	Reel Width W1 (mm)	A0 (mm)	B0 (mm)	K0 (mm)	P1 (mm)	W (mm)	Pin1 Quadrant
CSD85301Q2	WSON	DQK	6	3000	180.0	8.4	2.3	2.3	1.0	4.0	8.0	Q1
CSD85301Q2	WSON	DQK	6	3000	180.0	9.5	2.3	2.3	1.0	4.0	8.0	Q1
CSD85301Q2T	WSON	DQK	6	250	180.0	8.4	2.3	2.3	1.0	4.0	8.0	Q1

TAPE AND REEL BOX DIMENSIONS

*All dimensions are nominal

Device	Package Type	Package Drawing	Pins	SPQ	Length (mm)	Width (mm)	Height (mm)
CSD85301Q2	WSON	DQK	6	3000	550.0	455.0	55.0
CSD85301Q2	WSON	DQK	6	3000	189.0	185.0	36.0
CSD85301Q2T	WSON	DQK	6	250	550.0	455.0	55.0

IMPORTANT NOTICE AND DISCLAIMER

TI PROVIDES TECHNICAL AND RELIABILITY DATA (INCLUDING DATASHEETS), DESIGN RESOURCES (INCLUDING REFERENCE DESIGNS), APPLICATION OR OTHER DESIGN ADVICE, WEB TOOLS, SAFETY INFORMATION, AND OTHER RESOURCES "AS IS" AND WITH ALL FAULTS, AND DISCLAIMS ALL WARRANTIES, EXPRESS AND IMPLIED, INCLUDING WITHOUT LIMITATION ANY IMPLIED WARRANTIES OF MERCHANTABILITY, FITNESS FOR A PARTICULAR PURPOSE OR NON-INFRINGEMENT OF THIRD PARTY INTELLECTUAL PROPERTY RIGHTS.

These resources are intended for skilled developers designing with TI products. You are solely responsible for (1) selecting the appropriate TI products for your application, (2) designing, validating and testing your application, and (3) ensuring your application meets applicable standards, and any other safety, security, or other requirements. These resources are subject to change without notice. TI grants you permission to use these resources only for development of an application that uses the TI products described in the resource. Other reproduction and display of these resources is prohibited. No license is granted to any other TI intellectual property right or to any third party intellectual property right. TI disclaims responsibility for, and you will fully indemnify TI and its representatives against, any claims, damages, costs, losses, and liabilities arising out of your use of these resources.

TI's products are provided subject to TI's Terms of Sale (www.ti.com/legal/termsofsale.html) or other applicable terms available either on ti.com or provided in conjunction with such TI products. TI's provision of these resources does not expand or otherwise alter TI's applicable warranties or warranty disclaimers for TI products.

Mailing Address: Texas Instruments, Post Office Box 655303, Dallas, Texas 75265
Copyright © 2019, Texas Instruments Incorporated