

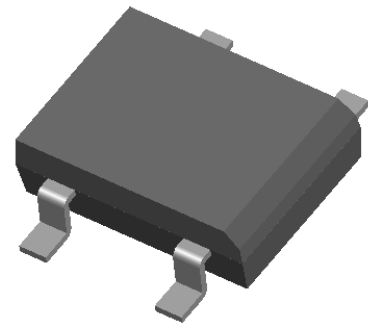

Bridge Rectifiers
Reverse Voltage-1000v
Forward current-1A

Features

- Glass passivated chip
- High surge current capability
- Ideal for surface mounted applications
- Low power loss, high efficiency
- Plastic Case Material has UL Flammability



Mechanical Data

- Package: DBS
- Terminals: Tin Plated leads, solderable per Mil-STD-750 Method 2026
- Polarity: As marked
- Molding compound meets UL 94 V-0 flammability rating, ROHS-compliant

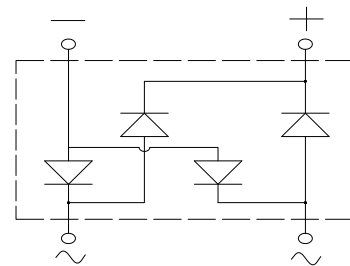

Maximum Ratings (Ta=25°C Unless otherwise specified)

Type Number	SYMBOL	DB107S	Umit
Maximum Recurrent Peak Reverse Voltage	V_{RRM}	1000	V
Maximum RMS Voltage	V_{RMS}	700	V
Maximum DC Blocking Voltage	V_{DC}	1000	V
Maximum Average Forward Rectified Current at TL = 100 °C	$I_{O(AV)}$	1.0	A
Peak Forward Surge Current 8.3ms Single half-sine-wave superimposed on rated load(JEDEC Method) on rated	IFSM	30.0	A
Forward Surge Current (Non-repetitive) @1ms, square wave, 1 cycle, Tj=25°C		60.0	A
Current squared time @1ms≤t8.3≤ms Tj=25°C, Rating of per diode	I^2t	3.7	A ² S
Maximum Forward Voltage at 1.0A DC	V_{FM}	1.1	V
Maximum Reverse Current TA = 25°C	IR	5	uA
at Rated DC Blocking Voltage TA = 100°C		100	
Typical Thermal Resistance	R_{QJa}	75.0	°C/W
Operating Junction Temperature Range	T_J	-55to+150	°C
Storage Temperature Range	T_{STG}	-55to+150	°C



FIG. 1 MAXIMUM AVERAGE FORWARD CURRENT DERATING

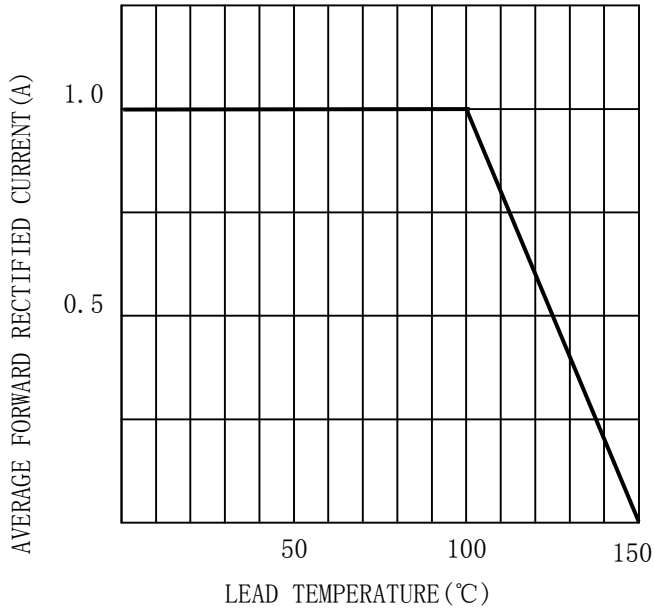

FIG. 2 TYPICAL FORWARD CHARACTERISTICS

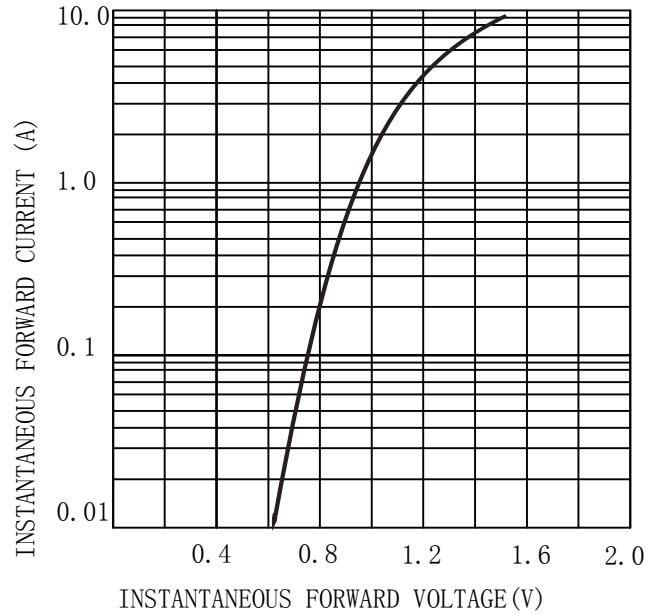

FIG. 3 MAXIMUM NON-REPEITIVE SURGE CURRENT

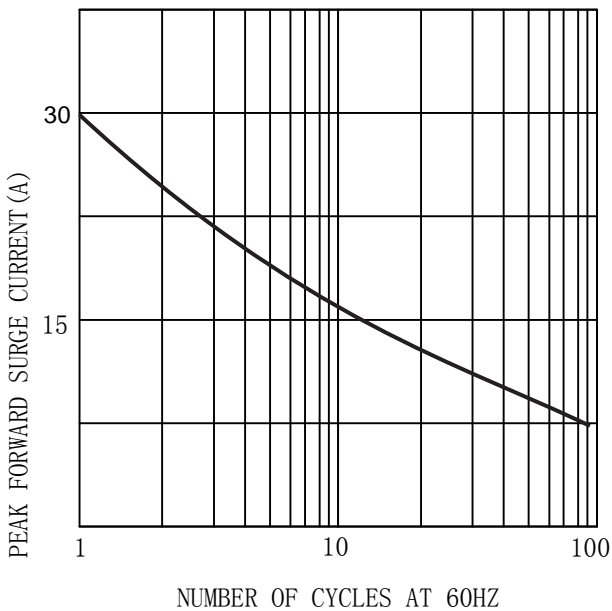
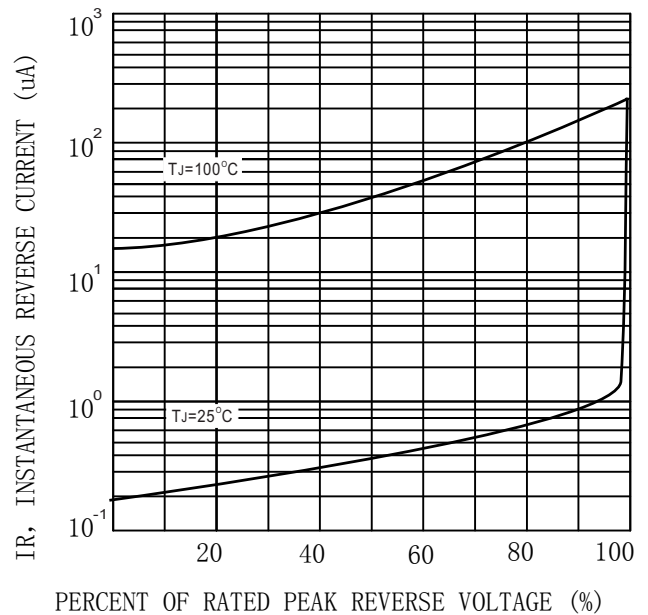
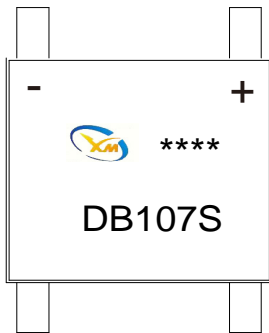

FIG. 4 TYPICAL REVERSE CHARACTERISTICS (per element)





MARKING INFORMATION



= Logo

**** = Date Code Marking

DB107S = Marking Code

Print according to customer request

PACKING REQUIRMENTS

- Carrier tape packing

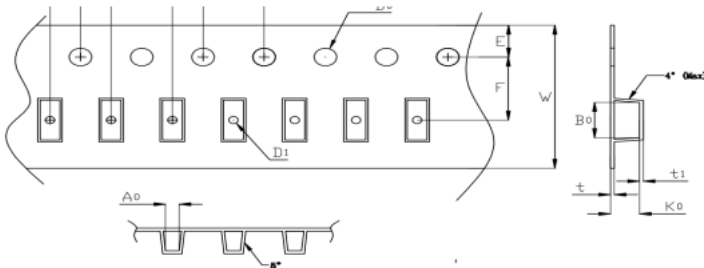

Specifications	Carrier tape type	Ao	Bo	Ko	Po	W	t1	Explain
DBS	Anti-static	8.70± 0.10	10.41±0.10	3.30± 0.10	4.00± 0.10	16.0± 0.30	0.25± 0.05	

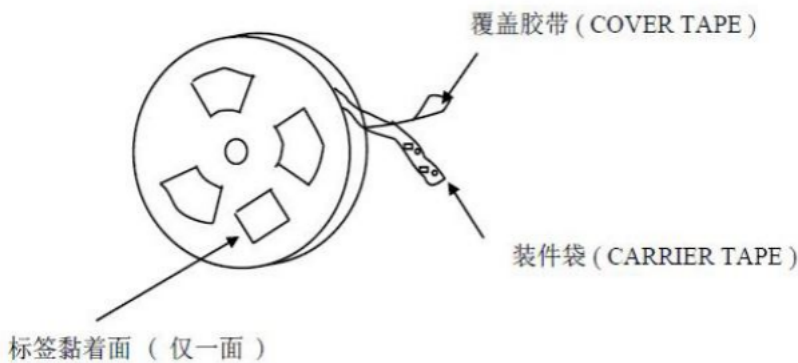

DEVICE TYPE	Tape width	13" Reel		
		Q'TY/REEL (pcs)	BOX/CAR TOON	Q'TY/REEL (pcs)
DBS	16mm	1500	18	27000



Outline Dimensions

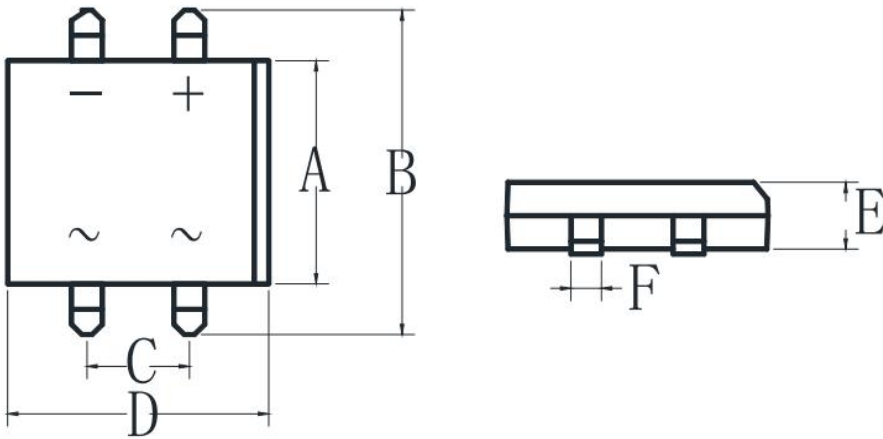

DBS				
DIM	INC HES		MM	
	MIN	MAX	MIN	MAX
A	0.24	0.26	6.10	6.50
B	0.37	0.39	9.50	9.90
C	0.19	0.20	4.80	5.20
D	0.31	0.33	7.95	8.35
E	0.09	0.11	2.30	2.70
F	0.04	0.05	0.90	1.20



Important Statements and disclaimers.

Do not copy or modify file information without permission.

Xumao Micro reserves the right to modify this document and its products.

Specifications are available without prior notice. Customer shall obtain and confirm the latest product information and specifications prior to final design, purchase or use.

Xumao Micro does not assume any implied warranties, including warranties of fitness for special purposes, non-infringement and merchantability.

The products shown here are not designed and licensed for demanding equipment at a level of reliability or for human life and any life-saving related applications or life-sustaining, such as medical devices, transportation equipment, aerospace machinery, and so on. Customers who use or sell these products for such applications do so at their own risk.

As Xumao Micro uses batch number as tracking benchmark, please provide batch number for tracking in case of exception.