

ÜÖÖPÁBÜ[PÜ
ÄÖUT ÜŠÖEV

ÜÖXE	ÖÖPÁÖÖÜÖÜÖVÖP	ÖY	ÖÖVÖ
A0	NEW	X.YAN	2018.10.22

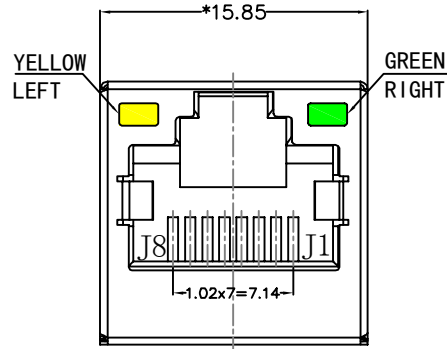

FRONT VIEW

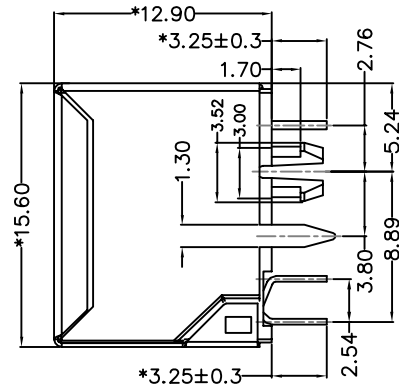

RIGHT SIDE VIEW

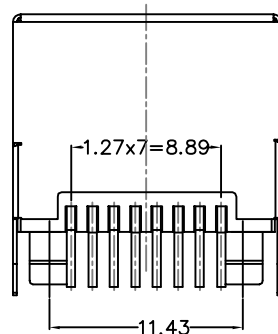

BACK VIEW

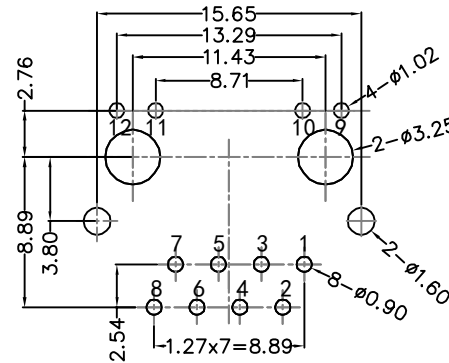

RECOMMENDED PCB LAYOUT
VIEWED FROM COMPONENT SIDE

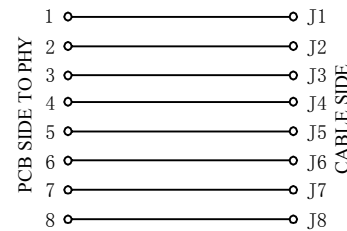

MATERIAL:

HOUSING: PBT,UL94V-0,BLACK.
TERMINALS BRACKET: PBT,UL94V-0,PINK.
TERMINAL: PHOSPHOR BRONZE T=0.35MM, 6U" GOLD PLATING.
SHIELD: C2680,T=0.20MM,20 MIN NICKEL PLATING ON ALL AREA.

MACHANICAL:

DURABILITY: 750 CYCLES MIN,12.5MM/MINUTE.
INSERTION FORCE: 2.2KG.F MAX.
RETENTION STRENGTH : 7.7KG.F BETWEEN JACK AND PLUG.
OPERATING TEMPERATURE: -40°C~+85°C.
STORAGE TEMPERATURE: -40°C~+85°C.
ALL CRITICAL DIMENSIONS WITH "*"

ELECTRICAL:

VOLTAGE: 125 VOLTS AC.
CURRENT RATING : 1.5AMP.
DIELECTRIC STRENGTH: 1000 VAC RMS 50HZ OR 60HZ,1MIN.
INSULATION RESISTANCE: 500 MEGA OHMS MIN. INITIAL AFTER 500V DC FOR 1 MINUTE.
CONTACT RESISTANCE: SINGLE TERMINAL 30 MILLIOHMS MAX. INITIAL 50 MILLIOHMS MAX. AFTER DURABILITY TEST.

LED Specification

Standard LED Color	LED Wavelength	Foward(A)	Foward(V)
Green	568nm	20mA	1.85-2.45V
Yellow	585nm	20mA	1.7-2.2V

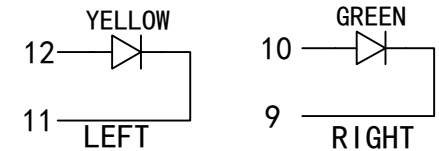

CND-tek
磁联达

深圳磁联达电子有限公司
Shenzhen magnetic Lianda Electronics Co., LTD
Address: 505, West Block, No. 221, Niucheng Road, Niucheng Village, Baiwang Community, Xili Street, Nanshan District, Shenzhen
E-mail: sales1@cd-tek.com 0755-27652992 29016433 Website:www.cd-tek.com

VÖSÖK
180° TAB-UP 8P8C

ÜÄVÄÜK
R1188ER52UT

ÜÖT ÄÜSK

ÜQÖ
T T ÖPá

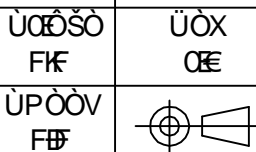

ÖÖPÖÜÖSÄU SÖÜÖÖÜ
WÖSÖÜÄÜÖÖÖÖ

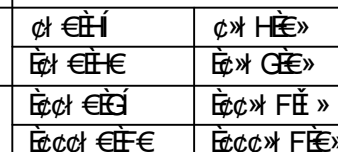

ÖÜÜÜXÖÖÖYK
QG.CHEN

ÖPÖÖSÖÖÖYK
SL.WANG

ÖÖÜÖPÖÖYK
X.YAN