

SAMZO REAC/ROHS

REV	ECN NO	DESCRIPTION	DESIGN	APPROVAL	DATE
A1	NEW	Replace frame			2020.06.12

E

D

C

B

E

D

C

B

A

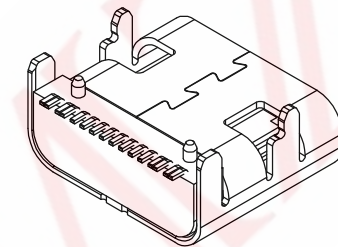
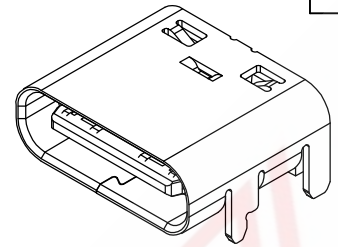
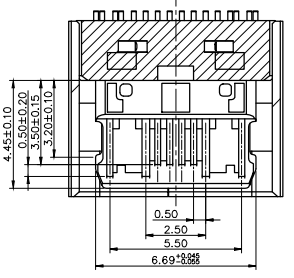
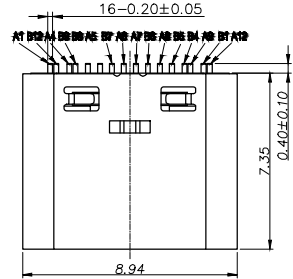

NOTE:

- MATERIAL SPECIFICATION:**
 - CONTACTS: COPPER ALLOY
 - MID PLATE: 201/301/304 STAINLESS STEEL
 - FRONT SHELL: 201/301/304 STAINLESS STEEL
- PLATING SPECIFICATION:**
 - CONTACTS: Ni 30-120u" MIN. UNDER PLATED OVER ALL. Au PLATED ON THE FUNCTIONAL AREA OF CONTACT (0.6-30u") . PLATING SPECIFICATIONS OF THE SOLDER AREA FOLLOW THE P/N
 - FRONT SHELL: SEE TABLE 1.
 - SHIELD PLATE&EMI PLATE: CLEAR ONLY
- MECHANICAL PERFORMANCE,**
 - INSERTION FORCE: 0.5~2.0kgf.
 - REMOVAL FORCE: 0.8kgf~2.0kgf.
 - DURABILITY: 5000/10000 CYCLES.
- ELECTRICAL PERFORMANCE,**
 - CURRENT RATING: 5A
 - VOLTAGE RATING: 20V
 - LLCR: VBUS & GND PINS AND OTHER PINS: 40mΩ/PIN MAX. SHIELD: 50mΩ/MAX. LLCR MAX. CHANGE OF ALL PINS: 10mΩ.
 - INSULATION RESISTANCE: 100MΩ MIN
 - DIELECTRIC WITHSTAND VOLTAGE, AC 100V FOR 1 MINUTE.
- ENVIRONMENTAL PERFORMANCE:**

OPERATING TEMPERATURE: -25°C~+85°C.
- IR REFLOW:**

THE PEAK TEMPERATURE ON THE BOARD SHALL BE MAINTAINED FOR 10 SECONDS AT 260°C.

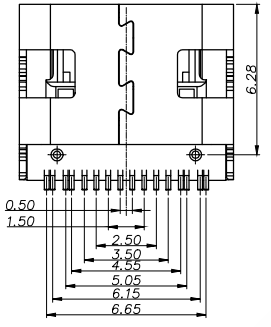
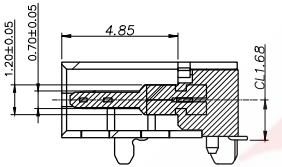
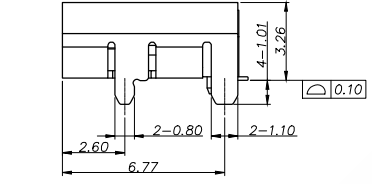
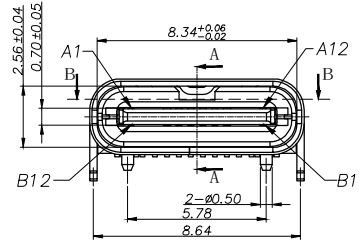

USB TYPE-C PIN ASSIGNMENTS

PIN NUMBER	SIGNAL NAME	PIN NUMBER	SIGNAL NAME
A1	GND	B12	GND
A4	VBUS	B9	VBUS
A5	CC1	B8	SBU1
A6	Dp1	B7	Dm1
A7	Dm1	B6	Dp1
A8	SBU1	B5	CC1
A9	VBUS	B4	VBUS
A12	GND	B1	GND

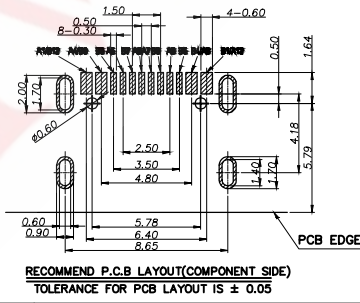

UKI BDTA**

(A)(B)(C)(D)(E)(F)(G)(H)

A. SERIE: UK-TYPE C
 B. SIZE: I-16pin
 C. MOUNTING: B-WD (pronr)
 D. LOOKS: D-L7.35
 E. STYIE: T-GENERAL
 F. MATERIAL: A-SUS201/C-SUS304
 G. LIFETIME: B:5000/C:10000CYCLES
 H. CODE: A-REGULAR

ITEM	DESCRIPTION	MATERIAL	QTY	FINSH/COLOR					
E	塑胶	LCP	1	黑色					
D	引脚	铜合金	1	镀金 0.8-1.0U			GENERAL TOLERANCE		
C	触点	铜合金	1	镀金 0.6-30U	DESIGN	WANGGUIFA	2020.06.12	≥2~5<	±0.25
B	中板	SUS201/301/304	1	镀镍 30-120U	CHECKED	ZHENGUILAN	2020.06.12	≥0~2<	±0.15
A	外壳	SUS201/301/304	1	镀镍 30-120U	APPROVED	LILIANJIANG	2020.06.14	≥5	±0.35

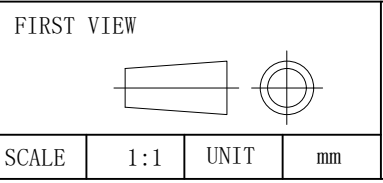

The copyright belongs to samzo parts [China] Co., Ltd. please use the material after samzo parts agree to authorize. The final right of interpretation belongs to samzo parts. WWW.KKK-JP.COM

TITLE: :	
TYPE-C 16Pin 7.35MM 板上型	
DWG NO: UKIB16-P0007	
PART NO: UKIB16730001	
MODEL NO: UKIBDT**-*-A	
NAME:	TYPE-C CONN

SAMZO COMPONENTS
 Electronic switch and connector manufacturer

1

2

3

4

5

6

7

8