

Standard SCRS

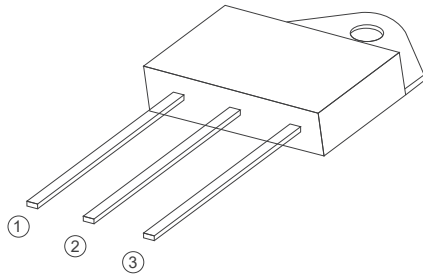

TO-3P Insulated

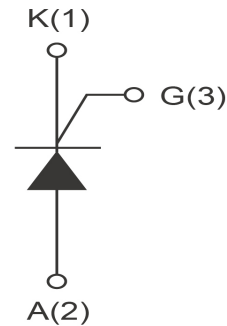

FEATURES

> IT(RMS):55A > VGT: 1.5V > VDRM VRRM:1000Vand1200V

APPLICATIONS

Washing machine, vacuums, massager, solid state relay, AC Motor speed regulation and so on.

Absolute Maximum Ratings (T_j=25°C unless otherwise specified)

Symbol	Parameter	Conditions	Ratings	Unit
VDRM VRRM	Repetitive Peak Off-State Voltage	BTW69-1200B	1200	V
		BTW69-1600B	1600	V
IT(RMS)	R.M.S On-State Current		55	A
IT(AV)	average On-State Current		35	A
ITSM	Surge On-State Current	F=50Hz, tp=10ms/8.3ms	550	A
I ² t	I ² t for fusing	Tp=10ms	1500	A ² s
PG(AV)	Average Gate Power Dissipation	T _j =125°C	1	W
PGM	Peak Gate Current	T _j =125°C	10	W
IGM	Peak Gate Current	tp=10us	5	A
T _j	Operating Junction Temperature		~40~125	°C
TSTG	Storage Temperature		~40~150	°C

Electrical Characteristics (T_j=25°C unless otherwise specified)

Symbol	Parameter	Test Conditions	Value	Unit
IDRM	Repetitive Peak Off-State Current	T _c =25°C	≤10	μA
		T _c =125°C	≤8	mA
IRRM	Repetitive Peak Reverse Current	T _c =25°C	≤10	μA
		T _c =125°C	≤8	mA
VTM	Forward "on" voltage	I _T =60A t _p =380us	≤1.8	V
VGD	Gate nontrigger voltage	V _D =V _{DRM} , T _j =125°C, R _L =3.3KΩ	≥0.2	V
IL	Latching current	I _G =1.2I _{GT}	≤250	mA
IH	Holding current	V _D =12V, I _{GT} =0.1A	≤200	mA
VGT	Gate trigger voltage	V _D =12V	≤1.5	V
IGT	Gate trigger current	V _D =12V, I _T =0.1A	≤70	mA
dv/dt	Critical-rate of rise of commutation voltage	V _D =2/3V _{DRM} , T _j =125°C, gate open circuit	≥100	V/us
di/dt	Critical-rate of rise of commutation current	I _G =2X I _{GT} , t _r 100us, T _j =125°C	≥150	A/us
R _{th(j-c)}	Thermal resistance	Junction to case	0.65	°C/W

FIG1

Maximum power dissipation versus RMS on-state current

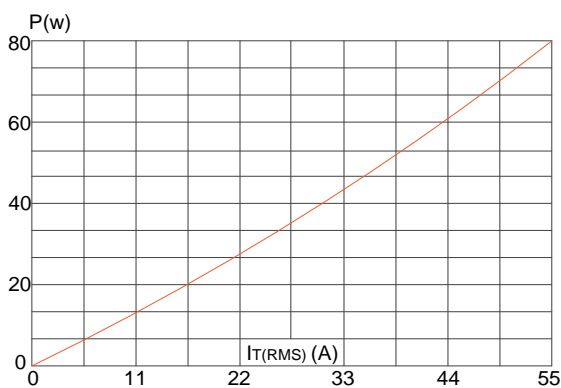

FIG2

RMS on-state current versus case temperature

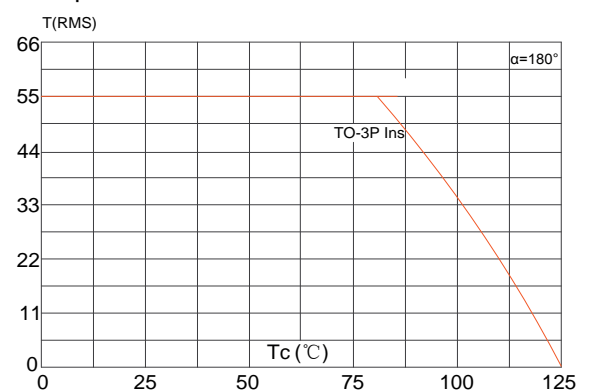

FIG3

Surge peak on-state current versus number of cycles

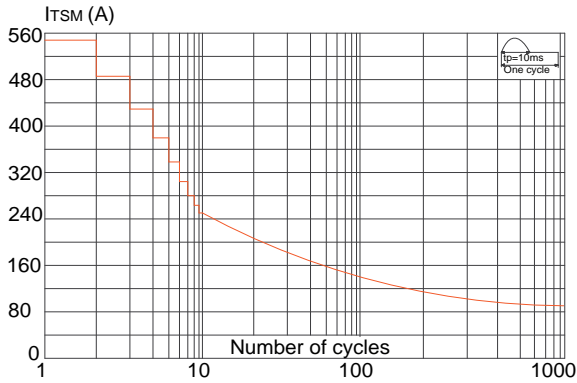

FIG4

On-state characteristics (maximum values)

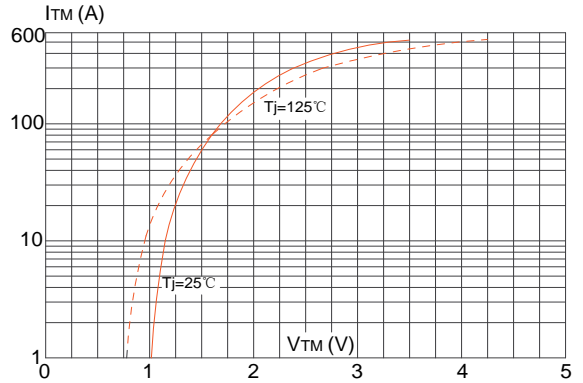

FIG5

Non-repetitive surge peak on-state current for a sinusoidal pulse with width $t_p < 20ms$, and corresponding value of I^2t ($di/dt < 100A/\mu s$)

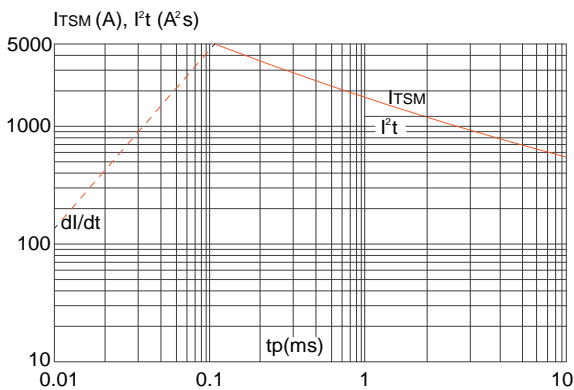
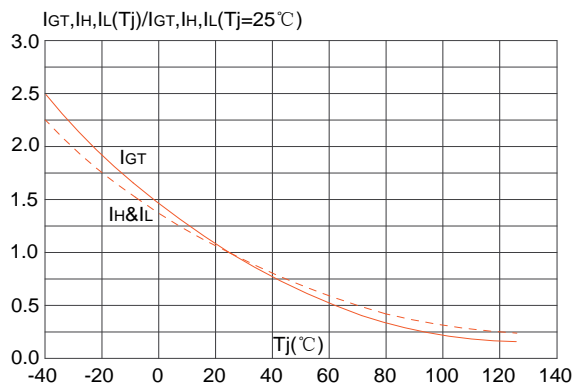
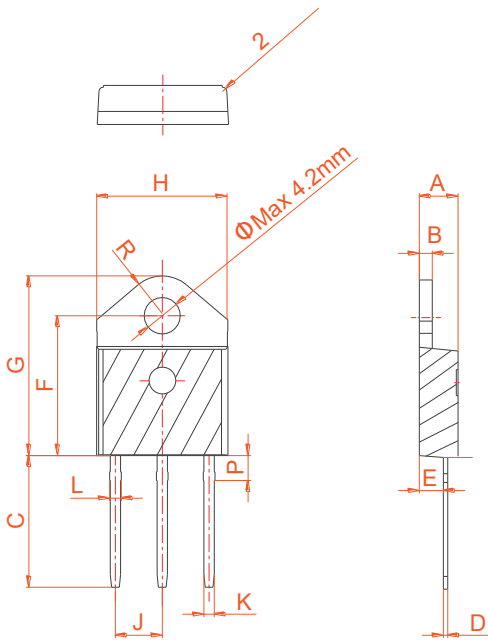

FIG6

Relative variations of gate trigger current, holding current and latching current versus junction temperature



PACKAGE MECHANICAL DATA



Ref.	Dimensions					
	Millimeters			Inches		
	Min.	Typ.	Max.	Min.	Typ.	Max.
A	4.40		4.60	0.173		0.181
B	1.45		1.55	0.057		0.061
C	14.35		15.60	0.565		0.614
D	0.50		0.70	0.020		0.028
E	2.70		2.90	0.106		0.114
F	15.80		16.50	0.622		0.650
G	20.40		21.10	0.803		0.831
H	15.10		15.50	0.594		0.610
J	5.40		5.65	0.213		0.222
K	1.10		1.40	0.043		0.055
L	1.35		1.50	0.053		0.059
P	2.80		3.00	0.110		0.118
R		4.35			0.171	