

# Hygienic Design Cylinder

Series **HY** □





A water resistant cylinder configured for easy cleaning

CJ5  
CG5

HY □

Water  
Resistant



Series	Bore size							External seal material	Body material	Optional parts*	Mounting brackets*	Page	
	20	25	32	40	50	63	80						100
<b>HYB</b> 	●	●	●	●	●	●	●	●	NBR, FKM	Aluminum	Plug bolt  External cover (Rod end / Head end)  Plug bolt	Foot Flange (ø32 to ø100)	1076
<b>HYQ</b> 	●	●	●	●	●	●	●	●				Foot Flange Single clevis Double clevis (ø32 to ø63)	1080
<b>HYC</b> 			●	●	●	●							1089
<b>HYG</b> 	●	●	●	●	●	●							1095

D-□

-X□

Technical data

\* Optional parts and mounting brackets must be ordered separately. Refer to pages 1107 to 1111.

# A water resistant cylinder

## Flat, grooveless configuration

Eliminates the auto switch groove and the holes for cushion needle holes, etc.

### Conventional

Cushion needle



## Scraper

Plug bolt  
(Option)

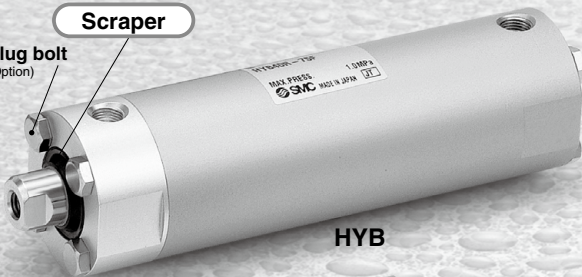

HYB

## Cushion needle

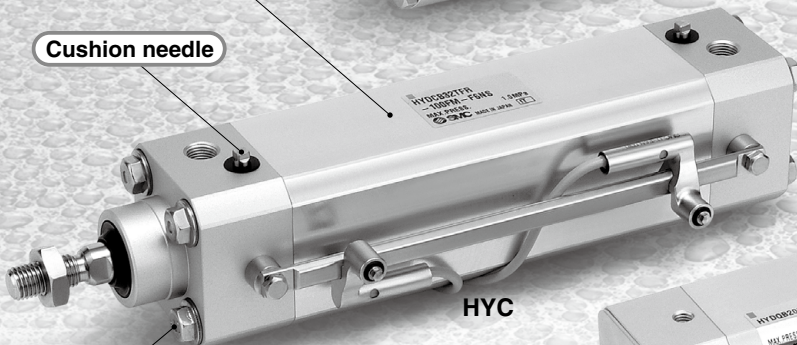

HYC

Plug bolt  
(Option)

External cover  
(Option)



HYQ

**Five times increase in service life compared to conventional model** (SMC ratio)

**Water-proof examination result** (Reference data)

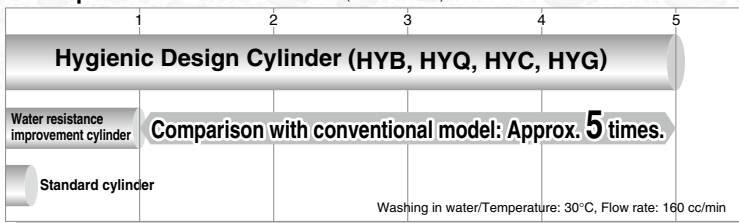

**Grease for food (NSF-H1 certified) is available.**

**External seal material: Choice of NBR or FKM**

**Mounting section: Conforms to ISO/VDMA standard. (Series HYC)**

Not applicable for use in a "food zone". For details, refer to Specific Product Precautions (Page 1112).

# configured for easy cleaning

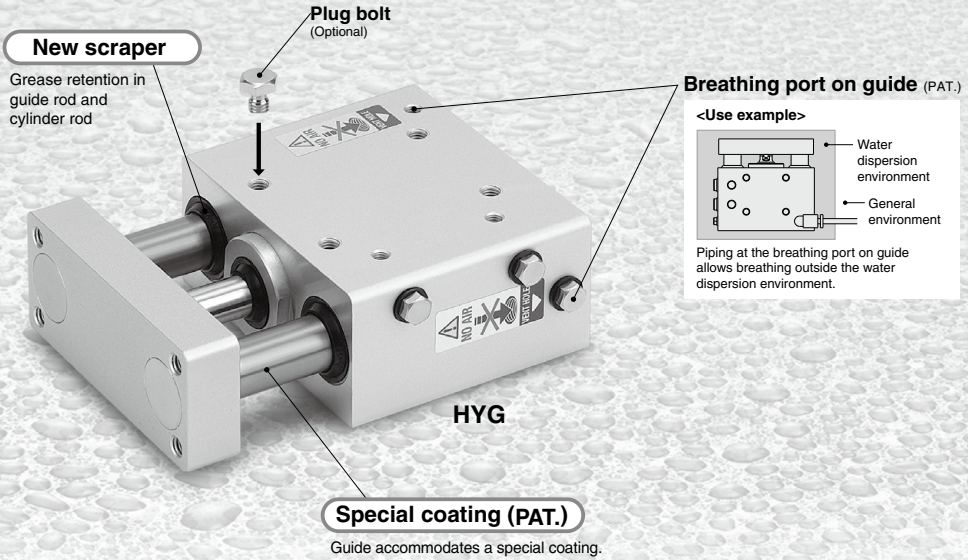

CJ5  
CG5  
**HY**  
Water Resistant

## ●Piping●

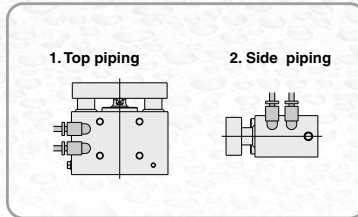

## ●Mounting●

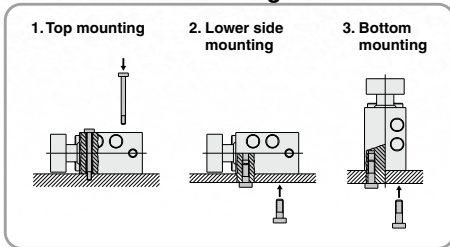

## ●Plug bolt●

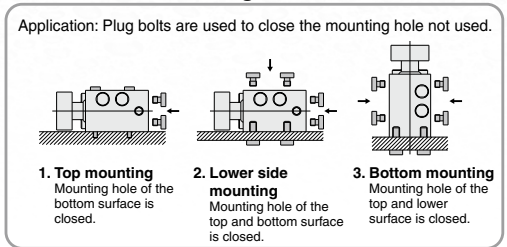

D-□  
-X□  
Technical data

# Hygienic Design Cylinder Round Type

## Series *HYB*

ø20, ø25, ø32, ø40, ø50, ø63, ø80, ø100

### How to Order

**HYB 20 [ ] R - 50 F**

**With auto switch** **HYDB 20 [ ] R - 50 F - H7BAL [ ]**

**With auto switch (Built-in magnet)**

**Bore size**

20	20 mm
25	25 mm
32	32 mm
40	40 mm
50	50 mm
63	63 mm
80	80 mm
100	100 mm

**Port thread type**

Nil	M thread	ø20, ø25
	Rc	
TN	NPT	ø32 to ø100
TF	G	

**Sealant material**

R	NBR
H	External FKM <sup>(Note)</sup>

(Note) External seal material:  
Rod scraper, tube gasket, and rod seal are made from FKM.

**Number of auto switches**

Nil	2 pcs.
S	1 pc.
n	"n" pcs.

**Auto switch**

Nil	Without auto switch (Built-in magnet)
-----	---------------------------------------

Refer to table below for selection of applicable auto switch.

**Grease**

Nil	Standard grease (for non-food)
F	Grease for food

(Note) Select grease for food for use in a water dispersion environment or when washing a product with water.  
(Water resistance is insufficient with standard grease.)

**Cylinder stroke**

Refer to page 1077 for the standard stroke.

< Mounting bracket > Foot and flange (Rod end)  
< Option parts > Plug bolt  
Please place an order for above mentioned parts separately, please refer to pages 1107 to 1111 for details.

### Applicable Auto Switches/Refer to pages 1559 to 1673 for detailed auto switch specifications.

Type	Special function	Electrical entry	Indicator light	Wiring (Output)	Load voltage		Auto switch model		Lead wire length (m)*		Pre-wired connector	Applicable load
					DC	AC	ø20 to ø63	ø80, ø100	3 (L)	5 (Z)		
<b>Solid state auto switch</b>	Water resistance improvement product (2-color display)	Grommet	Yes	2-wire	24 V	12 V	<b>H7BA</b>	<b>G5BA</b>	●	○	○	Relay, PLC

\* Lead wire length symbols  
3 m..... L (Example) H7BAL  
5 m..... Z (Example) H7BAZ

\* Auto switches marked with a "○" symbol are produced upon receipt of orders.

• Refer to pages 1626 and 1627 for detailed specifications about the auto switch with pre-wired connector.



### Symbol

Rubber bumper



## Specifications

Bore size (mm)	20	25	32	40	50	63	80	100
<b>Action</b>	Double acting, Single rod							
<b>Fluid</b>	Air							
<b>Minimum operating pressure</b>	0.2 MPa		0.15 MPa			0.07 MPa		
<b>Maximum operating pressure</b>	1.0 MPa							
<b>Proof pressure</b>	1.5 MPa							
<b>Ambient and operating fluid temperature</b>	Without auto switch 0°C to 70°C							
	With auto switch 0°C to 60°C							
<b>Lubrication</b>	Not required							
<b>Piston speed</b>	50 to 500 mm/s (With pressure at 1.0 MPa) <sup>Note)</sup>							
<b>Cushion</b>	Rubber bumper							
<b>Stroke length tolerance</b>	$^{+1.4}_0$ mm							
<b>Piston rod material</b>	Stainless steel 304 / Hard chrome plated							

CJ5  
CG5

HY□

Water  
Resistant

Note) Use a cylinder below the allowable kinetic energy. Refer to page 1078 for the allowable kinetic energy.

## Standard Stroke

Bore size (mm)	Standard stroke (mm)
<b>20</b>	25, 50, 75, 100, 125, 150, 200
<b>25 to 100</b>	25, 50, 75, 100, 125, 150, 200, 250, 300

\* Intermediate strokes of 1 mm each can be produced. (The spacer is not used.)

## Weight

### Without auto switch

Unit: kg

Bore size (mm)	Stroke (mm)									
	25	50	75	100	125	150	175	200	250	300
<b>20</b>	0.15	0.17	0.18	0.20	0.22	0.24	0.26	0.27	—	—
<b>25</b>	0.20	0.22	0.24	0.27	0.29	0.31	0.34	0.36	0.40	0.45
<b>32</b>	0.26	0.29	0.32	0.35	0.38	0.41	0.44	0.47	0.53	0.59
<b>40</b>	0.50	0.55	0.59	0.64	0.68	0.73	0.78	0.82	0.91	1.01
<b>50</b>	0.88	0.95	1.02	1.09	1.15	1.22	1.29	1.35	1.49	1.62
<b>63</b>	1.21	1.29	1.38	1.47	1.55	1.64	1.72	1.81	1.98	2.15
<b>80</b>	2.01	2.13	2.24	2.35	2.47	2.58	2.69	2.81	3.03	3.26
<b>100</b>	3.52	3.68	3.84	3.99	4.15	4.31	4.47	4.63	4.95	5.27

### With auto switch (Built-in magnet)

Unit: kg

Bore size (mm)	Stroke (mm)									
	25	50	75	100	125	150	175	200	250	300
<b>20</b>	0.15	0.17	0.19	0.21	0.22	0.24	0.26	0.28	—	—
<b>25</b>	0.20	0.22	0.25	0.27	0.29	0.32	0.34	0.36	0.41	0.46
<b>32</b>	0.28	0.31	0.33	0.36	0.39	0.42	0.45	0.48	0.54	0.60
<b>40</b>	0.51	0.56	0.61	0.65	0.70	0.74	0.79	0.83	0.93	1.02
<b>50</b>	0.90	0.97	1.03	1.10	1.17	1.23	1.30	1.37	1.50	1.64
<b>63</b>	1.23	1.32	1.40	1.49	1.58	1.66	1.75	1.83	2.00	2.17
<b>80</b>	2.04	2.16	2.27	2.38	2.50	2.61	2.72	2.84	3.06	3.29
<b>100</b>	3.55	3.71	3.87	4.03	4.19	4.35	4.51	4.67	4.98	5.30

## Theoretical Output

Unit: N

Bore size (mm)	Operating direction	Operating pressure (MPa)		
		0.3	0.5	0.7
<b>20</b>	OUT	94.2	157	220
	IN	79.2	132	185
<b>25</b>	OUT	147	246	344
	IN	124	206	288
<b>32</b>	OUT	241	402	563
	IN	207	346	484
<b>40</b>	OUT	378	630	882
	IN	318	530	742
<b>50</b>	OUT	588	980	1370
	IN	495	825	1160
<b>63</b>	OUT	936	1560	2180
	IN	840	1400	1960
<b>80</b>	OUT	1510	2520	3520
	IN	1360	2270	3180
<b>100</b>	OUT	2360	3930	5500
	IN	2150	3580	5010

D-□

-X□

Technical  
data

# Series HYB

## Allowable Load at Rod End

ø20, ø25, ø32, ø40

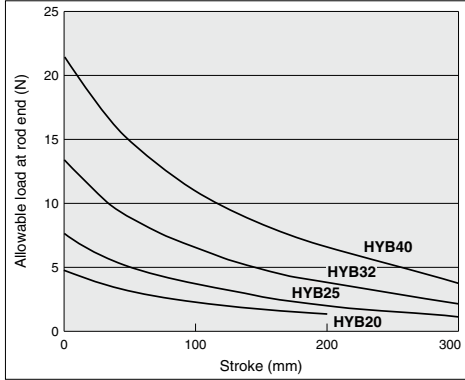

ø50, ø63, ø80, ø100

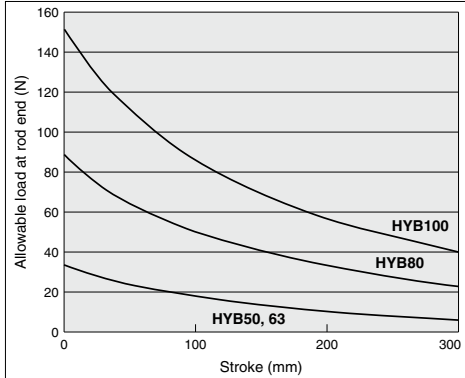

• A case where the center of gravity of the load rests 50 mm from the rod end.

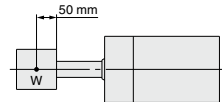

## Allowable Kinetic Energy

(Supply pressure: at P = 0.5 MPa)

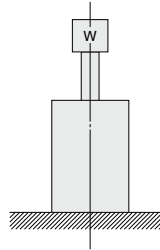
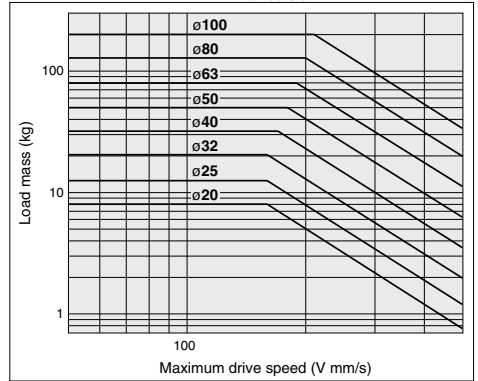

### Dimensions

HY□B20 to 100

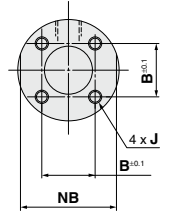
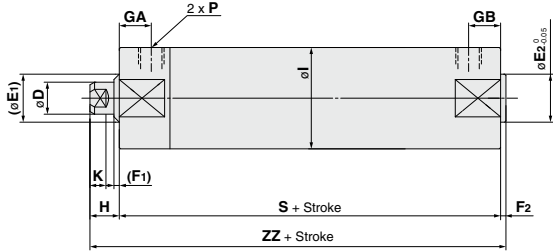
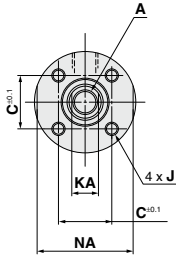

CJ5  
CG5

HY□

Water  
Resistant

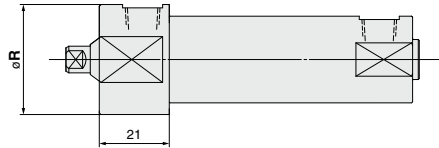

ø20, 25

(mm)

Bore size (mm)	A	B	C	D	E1	E2	F1	F2	GA		GB	H	I	J
									Port: M5, Rc, NPT	Port: G				
20	M4 x 0.7 depth 8	14	18.5	8	18	12	3	2	13		10	10	26	M4 x 0.7 depth 7
25	M5 x 0.8 depth 10	16.5	18.5	10	18	14	3	2	13		10	10	31	M5 x 0.8 depth 7.5
32	M6 x 1.0 depth 12	20	20	12	20	18	3	2	12	11	10	10	38	M5 x 0.8 depth 8
40	M8 x 1.25 depth 13	26	26	16	26	25	3	2	13	10	10	15	47	M6 x 1.0 depth 12
50	M10 x 1.5 depth 15	32	32	20	32	30	3	2	14	14	12	15	58	M8 x 1.25 depth 16
63	M10 x 1.5 depth 15	38	38	20	32	32	3	2	14	12	12	15	72	M10 x 1.5 depth 16
80	M16 x 2.0 depth 21	50	50	25	37	40	3	3	20	17	16	20	89	M10 x 1.5 depth 22
100	M20 x 2.5 depth 27	60	60	30	42	50	3	3	20	17	16	20	110	M12 x 1.75 depth 22

Bore size (mm)	K	KA	NA	NB	P			R	S	ZZ
					Nii	TF	TN			
20	5	6	30	24	M5 x 0.8	—	—	33	69	81
25	5	8	30	29	M5 x 0.8	—	—	33	69	81
32	6	10	35.5	35.5	Rc 1/8	G 1/8	NPT 1/8	—	71	83
40	6.5	13	44	44	Rc 1/8	G 1/8	NPT 1/8	—	78	95
50	8	16	55	55	Rc 1/4	G 1/4	NPT 1/4	—	90	107
63	8	16	69	69	Rc 1/4	G 1/4	NPT 1/4	—	90	107
80	9.5	22	80	80	Rc 3/8	G 3/8	NPT 3/8	—	108	131
100	11.5	27	100	100	Rc 1/2	G 1/2	NPT 1/2	—	108	131

D□

-X□

Technical  
data

# Hygienic Design Cylinder Basic Type

## Series *HYQ*

ø20, ø25, ø32, ø40, ø50, ø63

### How to Order

**HYQB 20 [ ] R - 50 F M**

**With auto switch** **HYDQB 20 [ ] R - 50 F M - F6B [ ]**

**With auto switch (Built-in magnet and switch rail)**

**Bore size**

20	20 mm
25	25 mm
32	32 mm
40	40 mm
50	50 mm
63	63 mm

**Port thread type**

Nil	M thread	ø20, ø25
	Rc	
TN	NPT	ø32 to ø63
TF	G	

**Sealant material**

R	NBR
H	External FKM <small>(Note)</small>

(Note) External seal material: Rod scraper, tube gasket, and rod seal are made from FKM.

**Number of auto switches**

Nii	2 pcs.
S	1 pc.
n	"n" pcs.

**Auto switch**

Nil	Without auto switch
-----	---------------------

Refer to table below for selection of applicable auto switch.

**Style of rod end**

Nil	Female thread
M	Male thread

**Grease**

Nil	Standard grease (for non-food)
F	Grease for food

(Note) Select grease for food for use in a water dispersion environment or when washing a product with water. (Water resistance is insufficient with standard grease.)

**Cylinder stroke**

Refer to page 1081 for the standard stroke.

< Mounting bracket > Foot, flange, single clevis, double clevis, and clevis pin  
< Option parts > External cover  
Please place an order for above mentioned parts separately, please refer to pages 1107 to 1111 for details.

### Applicable Auto Switches/Refer to pages 1559 to 1673 for detailed auto switch specifications.

Type	Electrical entry	Indicator light	Wiring (Output)	Load voltage		Auto switch model	Lead wire length (m) <sup>*</sup>			Pre-wired connector	Applicable load	
				DC			0.5 (Nil)	3 (L)	5 (Z)			
Solid state auto switch	Grommet	Yes	3-wire (NPN)	24 V	5 V	F6N	●	●	○	○	IC circuit	Relay, PLC
			3-wire (PNP)		12 V	F6P	●	●	○			
			2-wire		12 V	F6B	●	●	○			

\* Lead wire length symbols 0.5 m.....Nil (Example) F6B  
3 m.....L (Example) F6BL  
5 m.....Z (Example) F6BZ

\* Auto switches marked with a "○" symbol are produced upon receipt of orders.

\* Refer to pages 1626 and 1627 for detailed specifications about the auto switch with pre-wired connector.  
\* Auto switch is shipped not assembled with the cylinder.



## Specifications



Bore size (mm)	20	25	32	40	50	63
<b>Action</b>	Double acting, Single rod					
<b>Fluid</b>	Air					
<b>Minimum operating pressure</b>	0.2 MPa		0.15 MPa			
<b>Maximum operating pressure</b>	1.0 MPa					
<b>Proof pressure</b>	1.5 MPa					
<b>Ambient and operating fluid temperature</b>	Without auto switch 0 to 70°C					
	With auto switch 0 to 60°C					
<b>Lubrication</b>	Not required					
<b>Piston speed</b>	50 to 500 mm/s (With pressure at 1.0 MPa) <sup>Note)</sup>					
<b>Cushion</b>	Rubber bumper					
<b>Stroke length tolerance</b>	$^{+1.4}_{0}$ mm					
<b>Piston rod material</b>	Stainless steel 304 / Hard chrome plated					

Note) Use a cylinder below the allowable kinetic energy. Refer to page 1082 for the allowable kinetic energy.

CJ5  
CG5

HY□

Water  
Resistant

## Symbol

Rubber bumper

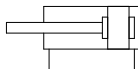

## Standard Stroke

Bore size (mm)	Standard stroke (mm)
<b>20</b>	5, 10, 15, 20, 25, 30, 35, 40, 45, 50
<b>25</b>	5, 10, 15, 20, 25, 30, 35, 40, 45, 50
<b>32</b>	5, 10, 15, 20, 25, 30, 35, 40, 45, 50, 75, 100
<b>40</b>	5, 10, 15, 20, 25, 30, 35, 40, 45, 50, 75, 100
<b>50</b>	10, 15, 20, 25, 30, 35, 40, 45, 50, 75, 100
<b>63</b>	10, 15, 20, 25, 30, 35, 40, 45, 50, 75, 100

\* Intermediate strokes of 1 mm each can be produced. (The spacer is not used.)

## Weight

### Without auto switch / Female thread type

Unit: kg

Bore size (mm)	Stroke (mm)											
	5	10	15	20	25	30	35	40	45	50	75	100
<b>20</b>	0.16	0.17	0.18	0.19	0.20	0.22	0.23	0.24	0.25	0.26	—	—
<b>25</b>	0.24	0.26	0.27	0.29	0.30	0.32	0.34	0.35	0.37	0.39	—	—
<b>32</b>	0.43	0.45	0.48	0.50	0.52	0.55	0.57	0.60	0.62	0.65	0.77	0.89
<b>40</b>	0.63	0.66	0.69	0.72	0.76	0.79	0.82	0.85	0.89	0.92	1.08	1.25
<b>50</b>	—	1.11	1.20	1.30	1.39	1.48	1.57	1.67	1.76	1.85	2.32	2.78
<b>63</b>	—	1.59	1.70	1.82	1.94	2.06	2.18	2.30	2.41	2.53	3.12	3.72

### Without auto switch / Male thread type

Unit: kg

Bore size (mm)	Stroke (mm)											
	5	10	15	20	25	30	35	40	45	50	75	100
<b>20</b>	0.16	0.18	0.19	0.20	0.21	0.22	0.23	0.24	0.25	0.27	—	—
<b>25</b>	0.25	0.27	0.28	0.30	0.32	0.33	0.35	0.36	0.38	0.40	—	—
<b>32</b>	0.45	0.48	0.50	0.52	0.55	0.57	0.60	0.62	0.65	0.67	0.79	0.91
<b>40</b>	0.66	0.70	0.73	0.76	0.79	0.83	0.86	0.89	0.92	0.96	1.12	1.28
<b>50</b>	—	1.28	1.37	1.46	1.55	1.65	1.74	1.83	1.93	2.02	2.48	2.95
<b>63</b>	—	1.68	1.80	1.92	2.04	2.15	2.27	2.39	2.51	2.63	3.22	3.81

### With auto switch (Built-in magnet and switch rail) / Female thread type

Unit: kg

Bore size (mm)	Stroke (mm)											
	5	10	15	20	25	30	35	40	45	50	75	100
<b>20</b>	0.21	0.22	0.23	0.24	0.26	0.27	0.28	0.29	0.31	0.32	—	—
<b>25</b>	0.30	0.32	0.33	0.35	0.37	0.39	0.40	0.42	0.44	0.46	—	—
<b>32</b>	0.54	0.56	0.59	0.61	0.64	0.66	0.69	0.72	0.74	0.77	0.90	1.02
<b>40</b>	0.77	0.81	0.84	0.87	0.90	0.94	0.97	1.00	1.03	1.07	1.23	1.39
<b>50</b>	—	1.30	1.40	1.49	1.59	1.68	1.78	1.87	1.97	2.06	2.53	3.01
<b>63</b>	—	1.86	1.98	2.10	2.22	2.34	2.46	2.58	2.70	2.82	3.42	4.02

### With auto switch (Built-in magnet and switch rail) / Male thread type

Unit: kg

Bore size (mm)	Stroke (mm)											
	5	10	15	20	25	30	35	40	45	50	75	100
<b>20</b>	0.21	0.22	0.24	0.25	0.26	0.27	0.29	0.30	0.31	0.32	—	—
<b>25</b>	0.31	0.33	0.35	0.36	0.38	0.40	0.42	0.43	0.45	0.47	—	—
<b>32</b>	0.56	0.59	0.61	0.64	0.66	0.69	0.71	0.74	0.77	0.79	0.92	1.05
<b>40</b>	0.81	0.84	0.88	0.91	0.94	0.97	1.01	1.04	1.07	1.10	1.27	1.43
<b>50</b>	—	1.47	1.57	1.66	1.76	1.85	1.94	2.04	2.13	2.23	2.70	3.17
<b>63</b>	—	1.96	2.08	2.20	2.31	2.43	2.55	2.67	2.79	2.91	3.51	4.11

## Theoretical Output

Bore size (mm)	Operating direction	Operating pressure (MPa)		Unit: N
		0.3	0.5	
<b>20</b>	IN	79.2	132	185
	OUT	94.2	157	220
<b>25</b>	IN	124	206	288
	OUT	147	246	344
<b>32</b>	IN	207	346	484
	OUT	241	402	563
<b>40</b>	IN	318	530	742
	OUT	378	630	882
<b>50</b>	IN	495	825	1160
	OUT	588	980	1370
<b>63</b>	IN	840	1400	1960
	OUT	936	1560	2180

D-□

-X□

Technical  
data

# Series HYQ

## Allowable Load at Rod End

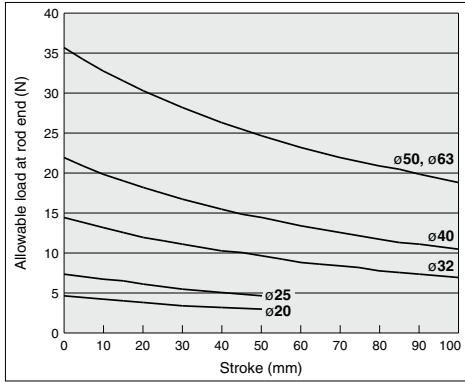

• The above graph shows a case that the center of gravity of the load rests 50 mm from the rod end.

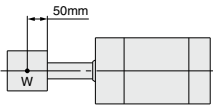

## Allowable Kinetic Energy

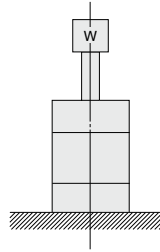
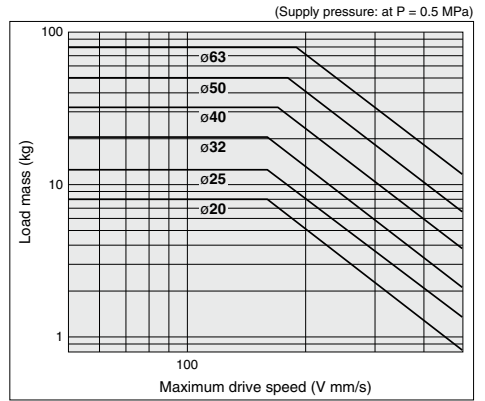

**Construction:  $\varnothing 20, \varnothing 25$**

**Basic type**

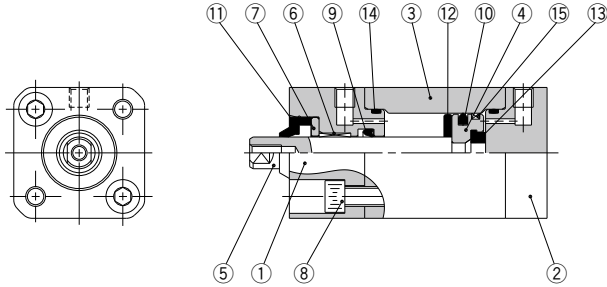

**CJ5**  
**CG5**  
**HY□**  
Water  
Resistant

**Rod end male thread**

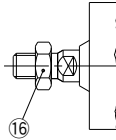

**Built-in magnet**

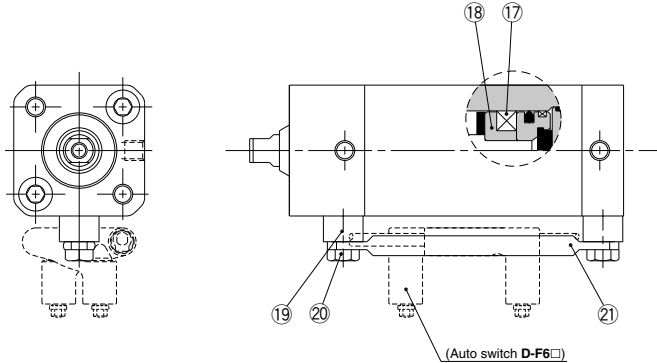

**Component Parts**

No.	Description	Material	Qty.	Note
1	Rod cover	Aluminum alloy	1	Anodic oxide film
2	Head cover	Aluminum alloy	1	Anodic oxide film
3	Cylinder tube	Aluminum alloy	1	Anodic oxide film
4	Piston	Aluminum alloy	1	Chromated
5	Piston rod	Stainless steel	1	Hard chromium plated
6	Bushing	Resin	1	
7	Bushing retainer	Aluminum alloy	1	Chromated
8	Hexagon socket head cap screw	Stainless steel	4	
9	Rod seal	NBR	1	(FKM can be selected.)
10	Piston seal	NBR	1	
11	Rod scraper	NBR	1	(FKM can be selected.)
12	Bumper A	Resin	1	
13	Bumper B	Resin	1	
14	Tube gasket	NBR	2	(FKM can be selected.)
15	Wearing	Resin	1	
16	Rod end nut	Stainless steel	1	(Only rod end male thread)

No.	Description	Material	Qty.	Note
17	Magnet	—	1	(Only built-in magnet)
18	Magnet holder	Aluminum alloy	1	(Only built-in magnet) Chromated
19	Switch rail base	Stainless steel	2	(Only built-in magnet)
20	Hexagon bolt	Stainless steel	2	(Only built-in magnet)
21	Switch rail	Stainless steel	1	(Only built-in magnet)

**Replacement Parts: Seal Kit**

Bore size	Part no.	Set contents
20	HYQB20□-PS	Set of nos. above ⑨, ⑩ and ⑭
25	HYQB25□-PS	

Place the seal material symbol in □.

Symbol	Material
R	NBR
H	External FKM*

- \* External seal: Rod seal and the tube gasket are made from FKM.
- \* Seal kit includes ⑨, ⑩ and ⑭. Order the seal kit based on each bore size.
- \* Since the seal kit does not include a grease pack, order it separately.

Grease for food part no.: GR-H-010 (10 g)  
Standard grease part no.: GR-S-010 (10 g)

**D-□**  
**-X□**  
Technical  
data

# Series HYQ

## Construction: $\phi 32$ to $\phi 63$

### Basic type

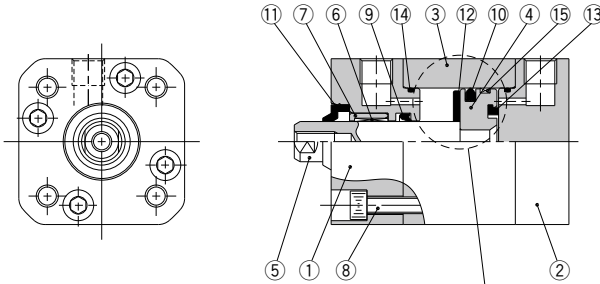

### Rod end male thread

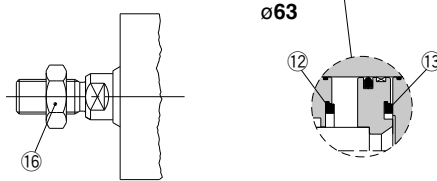

### Built-in magnet

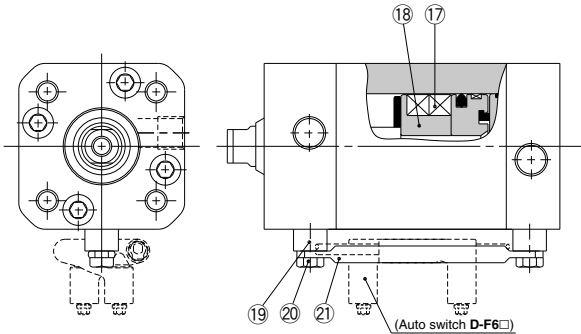

### Component Parts

No.	Description	Material	Qty.	Note
1	Rod cover	Aluminum alloy	1	Anodic oxide film
2	Head cover	Aluminum alloy	1	Anodic oxide film
3	Cylinder tube	Aluminum alloy	1	Anodic oxide film
4	Piston	Aluminum alloy	1	Chromated
5	Piston rod	Stainless steel	1	Hard chromium plated
6	Bushing	Resin	1	
7	Bushing retainer	Aluminum alloy	1	Chromated
8	Hexagon socket head cap screw	Stainless steel	8	
9	Rod seal	NBR	1	(FKM can be selected.)
10	Piston seal	NBR	1	
11	Rod scraper	NBR	1	(FKM can be selected.)
12	Bumper A	Resin	1	
13	Bumper B	Resin	1	(Only $\phi 63$ is common to the bumper A.)
14	Tube gasket	NBR	2	(FKM can be selected.)
15	Wearing	Resin	1	
16	Rod end nut	Stainless steel	1	(Only rod end male thread)
17	Magnet	—	2	(Only built-in magnet)

No.	Description	Material	Qty.	Note
18	Magnet holder	Aluminum alloy	1	(Only built-in magnet) Chromated
19	Switch rail base	Stainless steel	2	(Only built-in magnet)
20	Hexagon bolt	Stainless steel	2	(Only built-in magnet)
21	Switch rail	Stainless steel	1	(Only built-in magnet)

### Replacement Parts: Seal Kit

Bore size	Part no.	Set contents
32	HYQB32□-PS	Set of nos. above 9, 10 and 14
40	HYQB40□-PS	
50	HYQB50□-PS	
63	HYQB63□-PS	

Place the seal material symbol in □.

Symbol	Material
R	NBR
H	External FKM®

- \* External seal: Rod seal and the tube gasket are made from FKM.
- \* Seal kit includes 9, 10 and 14. Order the seal kit based on each bore size.
- \* Since the seal kit does not include a grease pack, order it separately.

Grease for food part no.: GR-H-010 (10 g)  
Standard grease part no.: GR-S-010 (10 g)

**Dimensions**

Without auto switch: **HYQB20, 25**

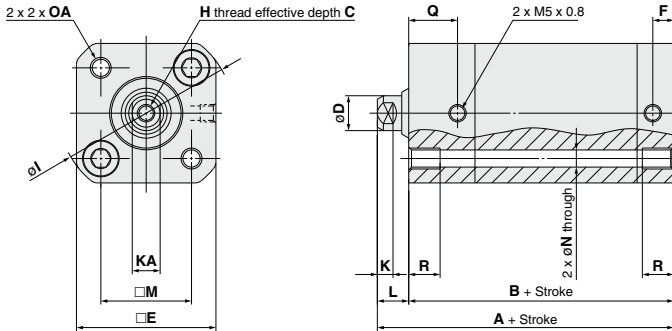

CJ5  
CG5  
**HY**  
Water  
Resistant

**Rod end male thread**

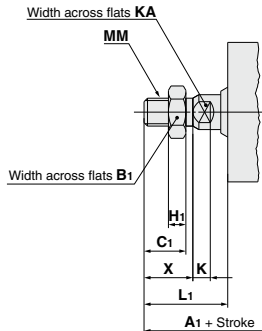

**Rod End Male Thread**

(mm)

Bore size	A1	B1	C1	MM	H1	K	KA	L1	X
20	72	10	10	M6 x 1.0	3.6	5	6	22	12
25	75	13	12	M8 x 1.25	5	5	8	24	14

(mm)

Bore size	Stroke range	A	B	C	D	E	F	H	I	K	KA	L	M	N	OA	Q	R
20	5 to 50	60	50	8	8	33	6	M4 x 0.7	42	5	6	10	22	4.4	M5 x 0.8	14	10
25	5 to 50	61	51	10	10	40	6	M5 x 0.8	50	5	8	10	26	5.4	M6 x 1.0	14	10

Note 1) Refer to pages 1107 to 1111 for details about the rod end nut, mounting bracket and accessory bracket.  
Note 2) When the unit is installed, ensure that dirt does not collect in the rod end (threaded portion).

D-  
-X  
Technical  
data

# Series HYQ

## Dimensions

With auto switch: HYDQB20, 25

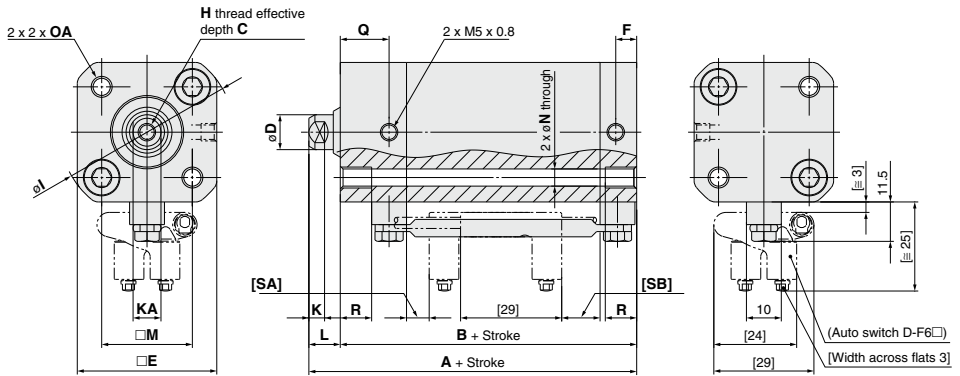

### Rod end male thread

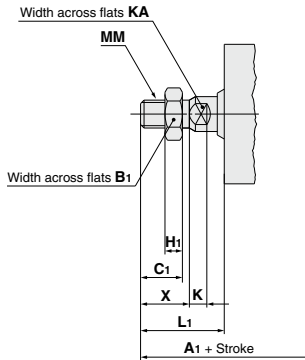

### Rod End Male Thread

Bore size	A1	B1	C1	MM	H1	K	KA	L1	X
20	82	10	10	M6 x 1.0	3.6	5	6	22	12
25	85	13	12	M8 x 1.25	5	5	8	24	14

Bore size	Stroke range	A	B	C	D	E	F	H	I	K	KA	L	M	N	OA	Q	R	SA	SB
20	5 to 50	70	60	8	8	33	6	M4 x 0.7	42	5	6	10	22	4.4	M5 x 0.8	14	10	6.5	10.5
25	5 to 50	71	61	10	10	40	6	M5 x 0.8	50	5	8	10	26	5.4	M6 x 1.0	14	10	6.5	11

Note 1) The [ ] value denotes dimensions with the auto switch D-F6□ mounted, which is dedicated to the Hygienic Design Cylinder.

Note 2) Refer to pages 1107 to 1111 for details about the rod end nut, mounting bracket and accessory bracket.

Note 3) When the unit is installed, ensure that dirt does not collect in the rod end (threaded portion).

## Dimensions

Without auto switch: HYQB32 to 63

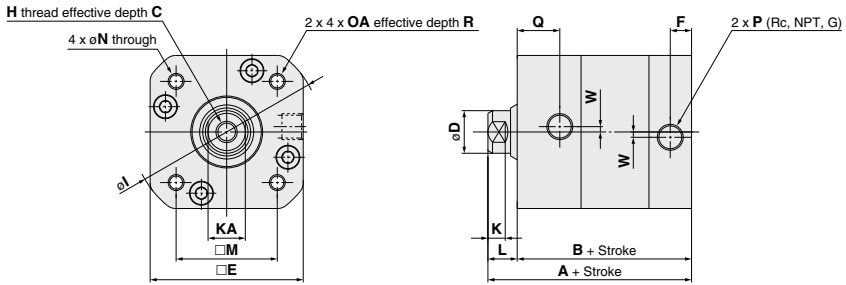

CJ5  
CG5

HY□

Water  
Resistant

### Rod end male thread

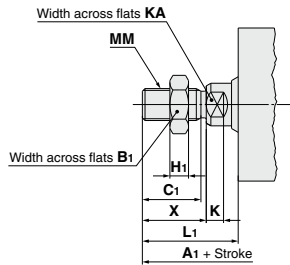

### Rod End Male Thread

(mm)

Bore size	A1	B1	C1	MM	H1	K	KA	L1	X
32	94	17	20	M10 x 1.25	6	6	10	33	22
40	101.5	19	22	M12 x 1.25	7	6.5	13	36	24
50	122.5	24	29.5	M16 x 1.5	10	8	16	46	32
63	123	24	29.5	M16 x 1.5	10	8	16	46	32

(mm)

Bore size	Stroke range	A	B	C	D	E	F	H	I	K	KA	L	M	N	OA	P	Q	R	W
32	5 to 100	72	61	12	12	49.5	8.5	M6 x 1.0	62	6	10	11	32.5	5.4	M6 x 1.0	1/8	13.5	16	4
40	5 to 100	77.5	65.5	13	16	57.5	8.5	M8 x 1.25	71	6.5	13	12	38	5.4	M6 x 1.0	1/8	16	16	2
50	10 to 100	90.5	76.5	15	20	69	10.5	M10 x 1.5	88	8	16	14	46.5	6.8	M8 x 1.25	1/4	20	16	4
63	10 to 100	91	77	18	20	84	10.5	M12 x 1.75	102	8	16	14	56.5	6.8	M8 x 1.25	1/4	21	16	4

Note 1) Refer to pages 1107 to 1111 for details about the rod end nut, mounting bracket and accessory bracket.

Note 2) When the unit is installed, ensure that dirt does not collect in the rod end (threaded portion).

D-□

-X□

Technical  
data

## Dimensions

With auto switch: HYDQB32 to 63

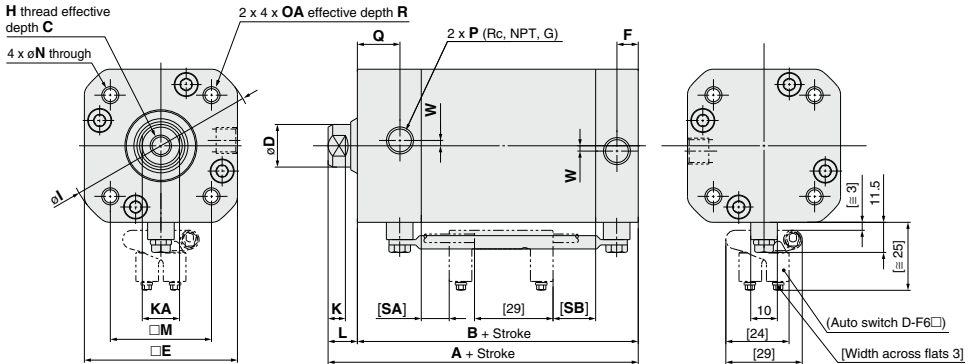

### Rod end male thread

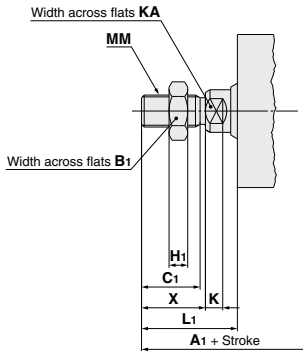

### Rod End Male Thread

Bore size	A <sub>1</sub>	B <sub>1</sub>	C <sub>1</sub>	MM	H <sub>1</sub>	K	KA	L <sub>1</sub>	X
32	109	17	20	M10 x 1.25	6	6	10	33	22
40	116.5	19	22	M12 x 1.25	7	6.5	13	36	24
50	137.5	24	29.5	M16 x 1.5	10	8	16	46	32
63	138	24	29.5	M16 x 1.5	10	8	16	46	32

Bore size	Stroke range	A	B	C	D	E	F	H	I	K	KA	L	M	N	OA	P	Q	R	SA	SB	W
32	5 to 100	87	76	12	12	49.5	8.5	M6 x 1.0	62	6	10	11	32.5	5.4	M6 x 1.0	1/8	13.5	16	8.5	16	4
40	5 to 100	92.5	80.5	13	16	57.5	8.5	M8 x 1.25	71	6.5	13	12	38	5.4	M6 x 1.0	1/8	16	16	10.5	16	2
50	10 to 100	105.5	91.5	15	20	69	10.5	M10 x 1.5	88	8	16	14	46.5	6.8	M8 x 1.25	1/4	20	16	10.5	17	4
63	10 to 100	106	92	18	20	84	10.5	M12 x 1.75	102	8	16	14	56.5	6.8	M8 x 1.25	1/4	21	16	9	18	4

Note 1) The [ ] value denotes dimensions with the auto switch D-F6 mounted, which is dedicated to the Hygienic Design Cylinder.

Note 2) Refer to pages 1107 to 1111 for details about the rod end nut, mounting bracket and accessory bracket.

Note 3) When the unit is installed, ensure that dirt does not collect in the rod end (threaded portion).



# Hygienic Design Cylinder ISO Standard Type

## Series *HYC*

ø32, ø40, ø50, ø63

CJ5  
CG5

HY□

Water  
Resistant

### How to Order

**HYCB 32 □ R - 500 F**

**With auto switch** **HYDCB 32 □ R - 500 F - F6B □**

**With auto switch  
(Built-in magnet and switch rail)**

**Bore size**

32	32 mm
40	40 mm
50	50 mm
63	63 mm

**Port thread type**

Nil	Rc
TN	NPT
TF	G

**Sealant material**

R	NBR
H	External FKM <small>(Note)</small>

(Note) External seal material:  
Rod scraper, tube gasket,  
rod seal and needle  
scraper are made from  
FKM.

**Number of auto switches**

Nil	2 pcs.
S	1 pc.
n	"n" pcs.

**Auto switch**

Nil	Without auto switch
-----	---------------------

Refer to table below for selection of  
applicable auto switch.

**Grease**

Nil	Standard grease (for non-food)
F	Grease for food

(Note) Select grease for food for use in a water  
dispersion environment or when washing  
a product with water.  
(Water resistance is insufficient with  
standard grease.)

**Cylinder stroke**

Refer to page 1090 for the  
standard stroke.

### Built-in Magnet Cylinder Model

If a built-in magnet cylinder without an auto switch is required, there is no need to enter the symbol for the auto switch.  
(Example) HYDCB40R-300F

< Mounting bracket > Foot, flange, single clevis, double clevis, and clevis pin  
< Option parts > Plug bolt

Please place an order for above mentioned parts separately, please refer to pages 1107 to 1111 for details.

### Applicable Auto Switches/Refer to pages 1559 to 1673 for detailed auto switch specifications.

Type	Electrical entry	Indicator light	Wiring (Output)	Load voltage		Auto switch model	Lead wire length (m) <sup>*</sup>			Pre-wired connector	Applicable load	
				DC	AC		0.5 (Nil)	3 (L)	5 (Z)		IC circuit	Relay, PLC
Solid state auto switch	Grommet	Yes	3-wire (NPN)	24 V	5 V	F6N	●	●	○	○		
			3-wire (PNP)		12 V	F6P	●	●	○			
			2-wire		12 V	F6B	●	●	○			

\* Lead wire length symbols 0.5 m..... Nil (Example) F6B  
3 m..... L (Example) F6BL  
5 m..... Z (Example) F6BZ

\* Auto switches marked with a "○" symbol are produced upon receipt of orders.

\* Refer to pages 1626 and 1627 for detailed specifications about the auto switch with pre-wired connector.

\* Auto switch is shipped not assembled with the cylinder.

D-□

-X□

Technical  
data



## Symbol

Air cushion

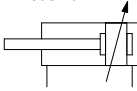

## Specifications

Bore size (mm)	32	40	50	63
<b>Action</b>	Double acting, Single rod			
<b>Fluid</b>	Air			
<b>Minimum operating pressure</b>	0.15 MPa			
<b>Maximum operating pressure</b>	1.0 MPa			
<b>Proof pressure</b>	1.5 MPa			
<b>Ambient and operating fluid temperature</b>	Without auto switch 0°C to 70°C			
	With auto switch 0°C to 60°C			
<b>Lubrication</b>	Not required			
<b>Piston speed</b>	50 to 500 mm/s (With pressure at 1.0 MPa) <sup>Note)</sup>			
<b>Cushion</b>	Air cushion			
<b>Stroke length tolerance</b>	250 mm <sup>+1.0</sup> <sub>0</sub> mm or less, 251 to 600 mm <sup>+1.4</sup> <sub>0</sub> mm			
<b>Piston rod material</b>	Stainless steel 304 / Hard chrome plated			

Note) Use a cylinder below the allowable kinetic energy. Refer to page 1091 for the allowable kinetic energy.

## Standard Stroke

Bore size (mm)	Standard stroke (mm)
<b>32</b>	25, 50, 75, 100, 125, 150, 200, 250, 300, 400, 500
<b>40</b>	25, 50, 75, 100, 125, 150, 200, 250, 300, 400, 500
<b>50</b>	25, 50, 75, 100, 125, 150, 200, 250, 300, 400, 500, 600
<b>63</b>	25, 50, 75, 100, 125, 150, 200, 250, 300, 400, 500, 600

\* Intermediate strokes of 1 mm each can be produced. (The spacer is not used.)

## Weight

### Without auto switch

Unit: kg

Bore size (mm)	Stroke (mm)											
	25	50	75	100	125	150	200	250	300	400	500	600
<b>32</b>	0.89	1.02	1.14	1.26	1.38	1.50	1.75	1.99	2.23	2.72	3.21	—
<b>40</b>	1.30	1.46	1.62	1.79	1.95	2.11	2.44	2.77	3.09	3.75	4.40	—
<b>50</b>	2.03	2.26	2.50	2.73	2.96	3.20	3.66	4.13	4.59	5.52	6.45	7.38
<b>63</b>	2.95	3.25	3.54	3.84	4.13	4.43	5.02	5.61	6.21	7.39	8.57	9.76

### With auto switch (Built-in magnet and switch rail)

Unit: kg

Bore size (mm)	Stroke (mm)											
	25	50	75	100	125	150	200	250	300	400	500	600
<b>32</b>	0.93	1.06	1.19	1.32	1.44	1.57	1.83	2.09	2.34	2.86	3.37	—
<b>40</b>	1.34	1.51	1.68	1.85	2.02	2.19	2.53	2.87	3.21	3.89	4.57	—
<b>50</b>	2.07	2.31	2.55	2.79	3.03	3.27	3.75	4.23	4.71	5.66	6.62	7.58
<b>63</b>	3.00	3.30	3.60	3.91	4.21	4.51	5.12	5.72	6.33	7.54	8.75	9.96

## Theoretical Output

Unit: N

Bore size (mm)	Operating direction	Operating pressure (MPa)		
		0.3	0.5	0.7
<b>32</b>	IN	207	346	484
	OUT	241	402	563
<b>40</b>	IN	318	530	742
	OUT	378	630	882
<b>50</b>	IN	495	825	1160
	OUT	588	980	1370
<b>63</b>	IN	840	1400	1960
	OUT	936	1560	2180

### Allowable Load at Rod End

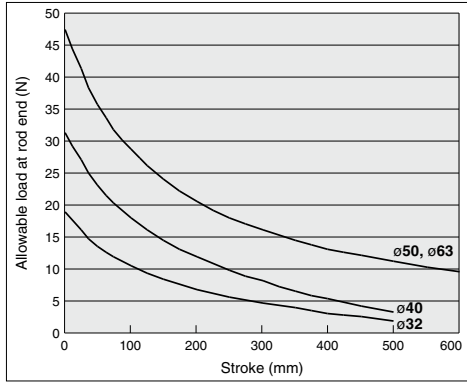

• A case where the center of gravity of the load rests 50 mm from the rod end.

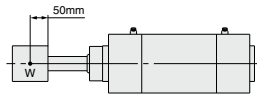

### Allowable Kinetic Energy

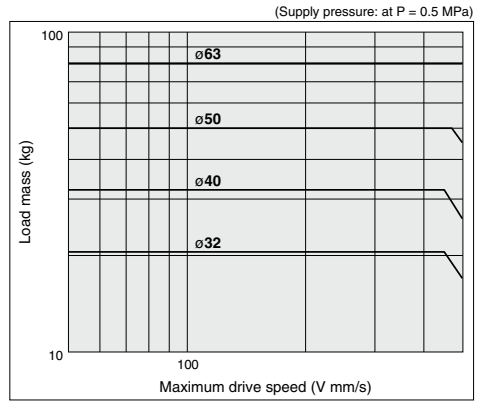

CJ5  
CG5

HYC

Water  
Resistant

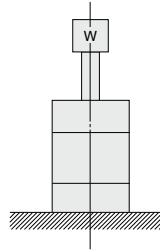

D-□

-X□

Technical  
data

# Series HYC

## Construction

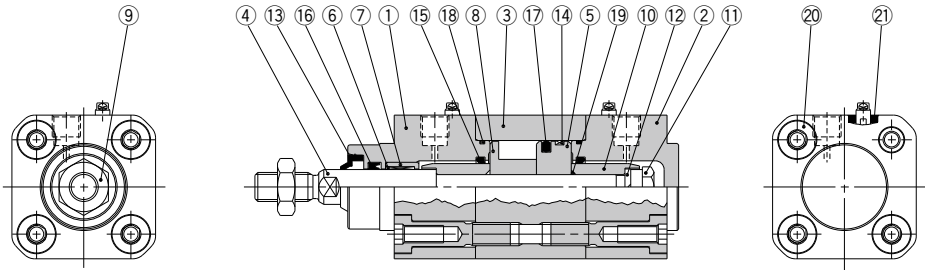

## Built-in magnet

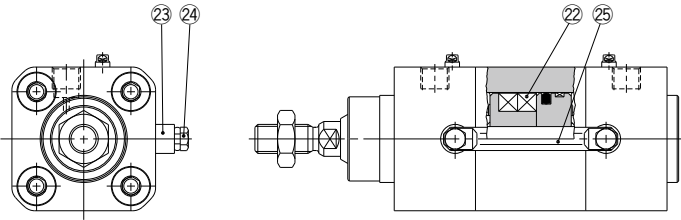

## Component Parts

No.	Description	Material	Qty.	Note
1	Rod cover	Aluminum alloy	1	Anodic oxide film
2	Head cover	Aluminum alloy	1	Anodic oxide film
3	Cylinder tube	Aluminum alloy	1	Anodic oxide film
4	Piston rod	Stainless steel	1	Hard chromium plated
5	Piston	Aluminum alloy	1	Chromated
6	Bushing	Resin	1	
7	Bushing retainer	Aluminum alloy	1	Chromated
8	Magnet holder	Aluminum alloy	1	Chromated
9	Rod end nut	Stainless steel	1	
10	Cushion ring	Steel	2	Zinc chromated
11	Piston nut	Stainless steel	1	
12	Spring washer	Steel	1	
13	Rod scraper	NBR	1	(FKM can be selected.)
14	Wearing	Resin	1	
15	Cushion seal	Resin	2	
16	Rod seal	NBR	1	(FKM can be selected.)
17	Piston seal	NBR	1	
18	Cylinder tube gasket	NBR	2	(FKM can be selected.)
19	Piston gasket	NBR	1	
20	Tie-rod bolt	Stainless steel	8	
21	Needle scraper	NBR	2	(FKM can be selected.)

No.	Description	Material	Qty.	Note
22	Magnet	—	2	(Only built-in magnet)
23	Switch rail base	Stainless steel	2	(Only built-in magnet)
24	Hexagon bolt	Stainless steel	2	(Only built-in magnet)
25	Switch rail	Stainless steel	1	(Only built-in magnet)

## Replacement Parts: Seal Kit

Bore Size	Part no.	Set contents
32	HYCB32□-PS	Set of nos. above (15, 16, 17, 18 and 21)
40	HYCB40□-PS	
50	HYCB50□-PS	
63	HYCB63□-PS	

Place the seal material symbol in □.

Symbol	Material
R	NBR
H	External FKM®

- \* External seal: Rod seal, the tube gasket and needle scraper are made from FKM.
- \* Seal kit includes (15, 16, 17, 18 and 21). Order the seal kit based on each bore size.
- \* Since the seal kit does not include a grease pack, order it separately.

Grease for food part no.: GR-H-010 (10 g)  
Standard grease part no.: GR-S-010 (10 g)

## Construction

Without auto switch: HYCB32 to 63

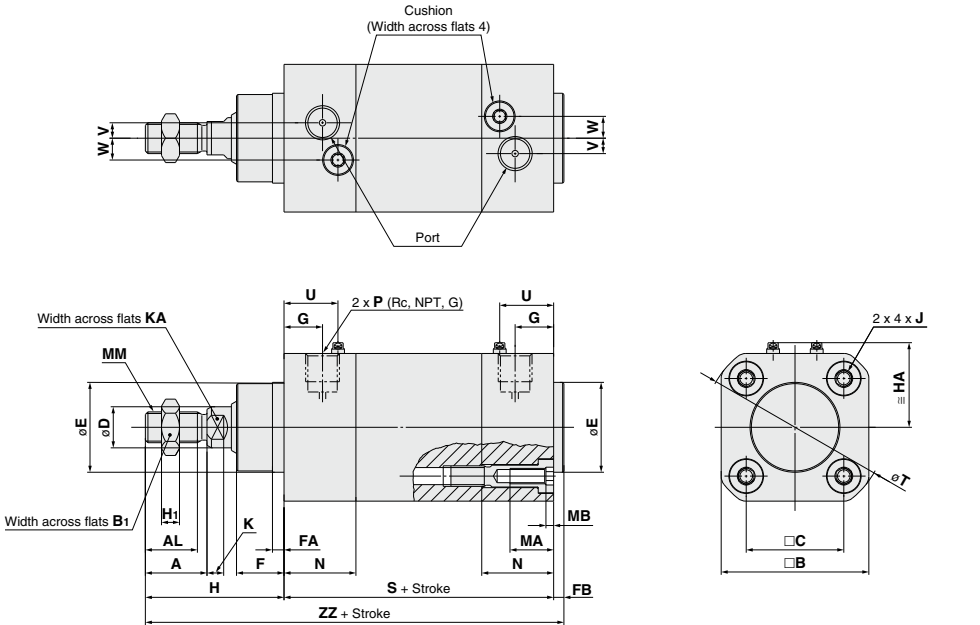

CJ5  
CG5

HY□

Water  
Resistant

		(mm)																											
Bore size	Stroke range	A	AL	B	B <sub>1</sub>	C	D	E <sup>ø11</sup>	F	FA	FB	G	H	H <sub>1</sub>	MA	MB	J	K	KA	MM	N	P	S	T	U	V	W	HA	ZZ
<b>32</b>	500 or less	22	18	50	17	32.5	12	30	16	5	4	14	48	6	16	3.2	M6 x 1	6	10	M10 x 1.25	28	1/8	94	62	21	6	6.5	30	146
<b>40</b>	500 or less	24	20	58	19	38	16	35	18.5	4.5	4	15	54	7	16	3.2	M6 x 1	6.5	13	M12 x 1.25	28	1/4	105	71	21	6	8.5	34	163
<b>50</b>	600 or less	32	27	70	24	46.5	20	40	23	5	4	17	69	10	16	4.2	M8 x 1.25	8	16	M16 x 1.5	32	1/4	106	88	25	8	11	40	179
<b>63</b>	600 or less	32	27	84	24	56.5	20	45	23	5	4	17	69	10	16	4.2	M8 x 1.25	8	16	M16 x 1.5	32	3/8	121	102	25	10	9	47	194

Note 1) Refer to pages 1107 to 1111 for details about the rod end nut, mounting bracket and accessory bracket.  
Note 2) When the unit is installed, ensure that dirt does not collect in the rod end (threaded portion).

D-□

-X□

Technical  
data

# Series HYC

## Construction

With auto switch: HYDCB32 to 63

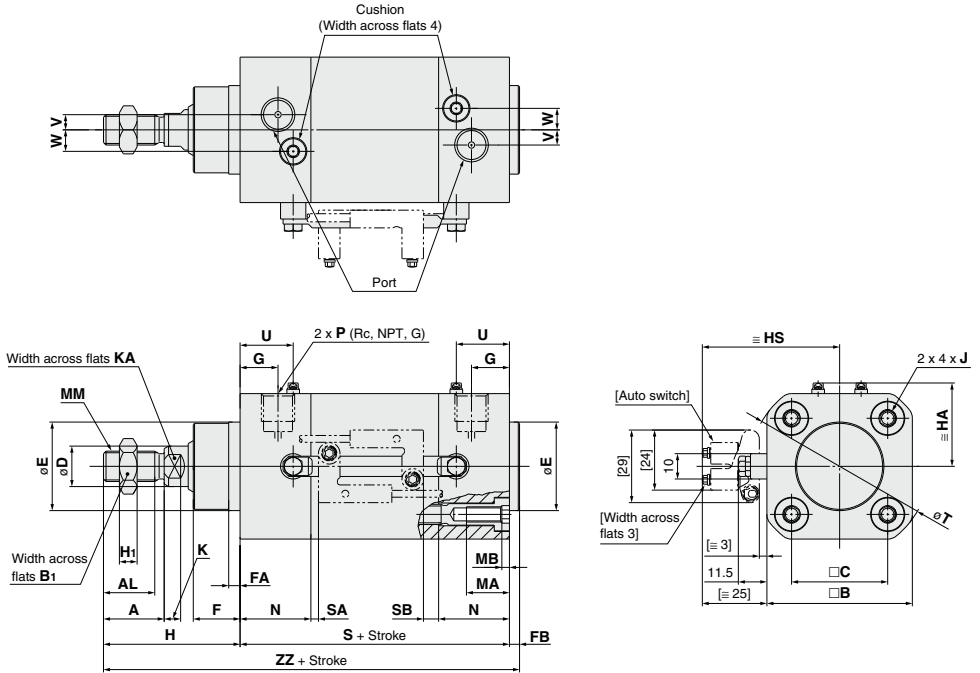

(mm)

Bore size	Stroke range	A	AL	B	B <sub>1</sub>	C	D	E <sup>ø11</sup>	F	FA	FB	G	H	H <sub>1</sub>	MA	MB	J	K	KA	MM	N	P	S	T	U	V	W	SA
32	500 or less	22	18	50	17	32.5	12	30	16	5	4	14	48	6	16	3.2	M6 x 1	6	10	M10 x 1.25	28	1/8	94	62	21	6	6.5	7.5
40	500 or less	24	20	58	19	38	16	35	18.5	4.5	4	15	54	7	16	3.2	M6 x 1	6.5	13	M12 x 1.25	28	1/4	105	71	21	6	8.5	12
50	600 or less	32	27	70	24	46.5	20	40	23	5	4	17	69	10	16	4.2	M8 x 1.25	8	16	M16 x 1.5	32	1/4	106	88	25	8	11	9
63	600 or less	32	27	84	24	56.5	20	45	23	5	4	17	69	10	16	4.2	M8 x 1.25	8	16	M16 x 1.5	32	3/8	121	102	25	10	9	19

Bore size	SB	HS	HA	ZZ
32	16.5	50	30	146
40	23	54	34	163
50	19	60	40	179
63	24	67	47	194

Note 1) The [ ] value denotes dimensions with the auto switch D-F6□ mounted, which is dedicated to the Hygienic Design Cylinder.

Note 2) Refer to pages 1107 to 1111 for details about the rod end nut, mounting bracket and accessory bracket.

Note 3) When the unit is installed, ensure that dirt does not collect in the rod end (threaded portion).

# Hygienic Design Cylinder

## Series *HYG*

ø20, ø25, ø32, ø40, ø50, ø63

CJ5  
CG5

HY□

Water  
Resistant

### How to Order

**HYG 20 □ R - 50 F**

**With auto switch**  
**HYDG 20 □ R - 50 F - F6B □**

**With auto switch (Built-in magnet and switch rail)**

**Bore size**

20	20 mm
25	25 mm
32	32 mm
40	40 mm
50	50 mm
63	63 mm

**Port thread type**

Nil	M thread	ø20, ø25
	Rc	
TN	NPT	ø32 to ø63
TF	G	

**Sealant material**

R	NBR
H	External FKM <small>Note</small>

Note External sealant: Scraper, rod seal, O-ring (rod end) and seal washer are made from FKM.

**Auto switch**

Nil	Without auto switch
-----	---------------------

Refer to the table below for selection of applicable auto switch.

Nil	2 pcs.
S	1 pc.
n	"n" pcs.

**Auto switch**

Nil	Standard grease (for non-food)
F	Grease for food

Note Select grease for food for use in a water dispersion environment or when washing a product with water. (Water resistance is insufficient with standard grease.)

**Grease**

**Cylinder stroke**

Refer to page 1096 for the standard stroke.

Optional parts (plug bolt) should be ordered separately. Please refer to page 1110 for details.

### Applicable Auto Switches/Refer to pages 1559 to 1673 for detailed auto switch specifications.

Type	Electrical entry	Indicator light	Wiring (Output)	Load voltage		Auto switch model	Lead wire length (m)*			Pre-wired connector	Applicable load	
				DC			0.5 (Nil)	3 (L)	5 (Z)			
Solid state auto switch	Grommet	Yes	3-wire (NPN)	24 V	5 V	F6N	●	●	○	○	IC circuit	Relay, PLC
			3-wire (PNP)		12 V	F6P	●	●	○			
			2-wire		12 V	F6B	●	●	○			

\* Lead wire length symbols 0.5 m..... Nil (Example) F6B  
3 m..... L (Example) F6BL  
5 m..... Z (Example) F6BZ

\* Auto switches marked with a "○" symbol are produced upon receipt of orders.

\* Refer to pages 1626 and 1627 for detailed specifications about the auto switch with pre-wired connector.

\* Auto switch is shipped not assembled with the cylinder.

D-□

-X□

Technical  
data



## Symbol

Rubber bumper

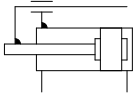

## Specifications

Bore size (mm)	20	25	32	40	50	63
<b>Action</b>	Double acting					
<b>Fluid</b>	Air					
<b>Minimum operating pressure</b>	0.2 MPa		0.15 MPa			
<b>Maximum operating pressure</b>	1.0 MPa					
<b>Proof pressure</b>	1.5 MPa					
<b>Ambient and operating fluid temperature</b>	0°C to 60°C					
<b>Lubrication</b>	Not required					
<b>Piston speed</b>	50 to 500 mm/s (With pressure at 1.0 MPa) <sup>Note)</sup>					
<b>Cushion</b>	Rubber bumper					
<b>Stroke length tolerance</b>	$^{+1.5}_0$ mm					

Note) Use a cylinder below the allowable kinetic energy. Refer to page 1099 for the allowable kinetic energy.

## Standard Stroke

Bore size (mm)	Standard stroke (mm)
<b>20</b>	20, 30, 50, 100, 150, 200
<b>25</b>	20, 30, 50, 100, 150, 200
<b>32</b>	25, 50, 100, 150, 200
<b>40</b>	25, 50, 100, 150, 200
<b>50</b>	25, 50, 100, 150, 200
<b>63</b>	25, 50, 100, 150, 200

\* Manufacture of Intermediate Stroke

Intermediate strokes of 1 mm each can be produced by using spacers with standard stroke cylinders. However, intermediate strokes of 5 mm each can be produced about ø40 to 63.

Example) HYG32R-57 mounts a 43 mm spacer in standard stroke cylinder HYG32R-100.

## Weight

### Without auto switch

Unit: kg

Bore size (mm)	Stroke (mm)						
	20	25	30	50	100	150	200
<b>20</b>	0.77	—	0.86	1.10	1.68	2.24	2.42
<b>25</b>	1.17	—	1.29	1.61	2.40	3.15	3.43
<b>32</b>	—	2.04	—	2.56	3.61	4.59	5.43
<b>40</b>	—	2.31	—	2.90	4.12	5.23	6.17
<b>50</b>	—	3.79	—	4.64	6.43	8.04	9.41
<b>63</b>	—	4.71	—	5.74	7.95	9.92	11.56

### With auto switch (Built-in magnet and switch rail)

Unit: kg

Bore size (mm)	Stroke (mm)						
	20	25	30	50	100	150	200
<b>20</b>	0.80	—	0.89	1.12	1.71	2.26	2.45
<b>25</b>	1.19	—	1.32	1.63	2.43	3.18	3.47
<b>32</b>	—	2.07	—	2.60	3.66	4.66	5.51
<b>40</b>	—	2.35	—	2.94	4.96	5.30	6.25
<b>50</b>	—	3.83	—	4.68	6.48	8.11	9.49
<b>63</b>	—	4.75	—	5.79	8.01	9.99	11.65

## Theoretical Output

Unit: N

Bore size (mm)	Operating direction	Operating pressure (MPa)		
		0.3	0.5	0.7
<b>20</b>	IN	71	118	165
	OUT	94	157	220
<b>25</b>	IN	113	189	265
	OUT	147	246	344
<b>32</b>	IN	181	302	422
	OUT	241	402	563
<b>40</b>	IN	317	528	739
	OUT	377	629	880
<b>50</b>	IN	495	825	1154
	OUT	589	982	1374
<b>63</b>	IN	841	1402	1962
	OUT	935	1559	2182



### Plate Allowable Rotational Torque

Strictly observe the values in the following table regarding rotational torque (T) pressurized to the plate (rod end).

When operated outside of the acceptable range, it can decrease the machine's service life.



### Plate Non-rotating Accuracy

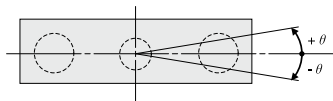

Unit: N•m

Bore size (mm)	Stroke (mm)						
	20	25	30	50	100	150	200
<b>20</b>	0.72	—	0.60	0.57	0.51	0.45	0.37
<b>25</b>	1.29	—	1.18	1.04	0.97	0.83	0.68
<b>32</b>	—	3.23	—	3.07	2.87	2.59	2.24
<b>40</b>	—	3.56	—	3.39	3.16	2.86	2.47
<b>50</b>	—	7.83	—	6.80	5.88	5.25	4.61
<b>63</b>	—	8.83	—	7.67	6.63	5.92	5.20

Bore size (mm)	Non-rotating accuracy $\theta$
<b>20</b>	$\pm 0.10$
<b>25</b>	$\pm 0.09$
<b>32</b>	$\pm 0.08$
<b>40</b>	$\pm 0.08$
<b>50</b>	$\pm 0.07$
<b>63</b>	$\pm 0.06$

\* When the cylinder retracts (initial value), for non-rotating accuracy in load-free states and/or except the guide rod deflection, use a value that does not exceed those listed above.

### Plate Allowable Moment

Strictly observe the values in the following table regarding allowed moment when eccentric distance is generated from the plate.

When operated outside of the acceptable range, it can decrease the machine's service life.

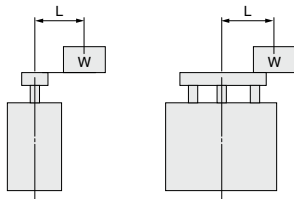

Allowable moment (N•m)	$\phi 20$	$\phi 25$	$\phi 32, \phi 40$	$\phi 50, \phi 63$
		3.57	5.07	21.5

CJ5  
CG5

HY□

Water  
Resistant

D-□

-X□

Technical  
data

# Series HYG

## Plate Allowable Lateral Load

Strictly observe the values in the following graph regarding lateral loads hanging upon the plate end point. When operated outside of the acceptable range, it can decrease the machine's service life.

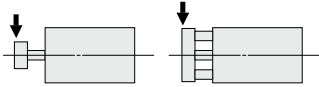

**HYG20**

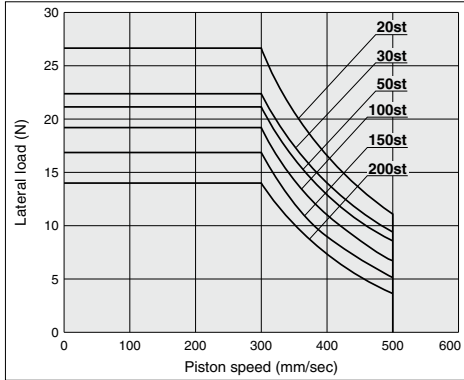

**HYG25**

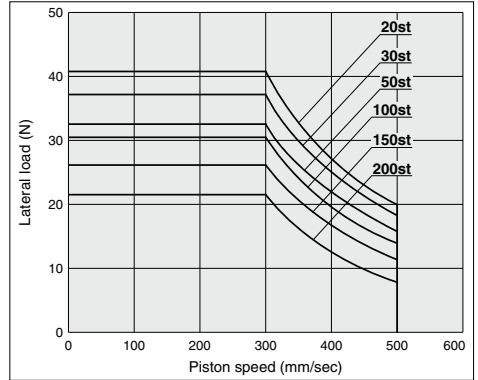

**HYG32, 40**

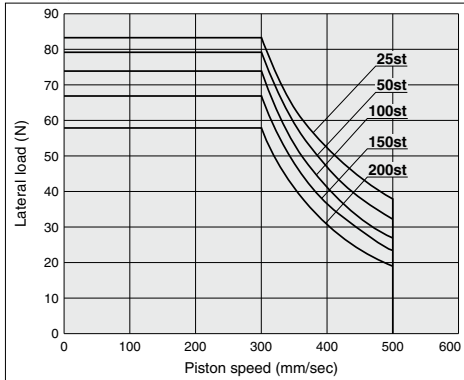

**HYG50, 63**

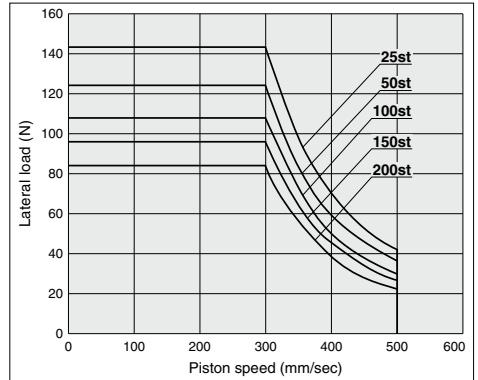

**Allowable Kinetic Energy**

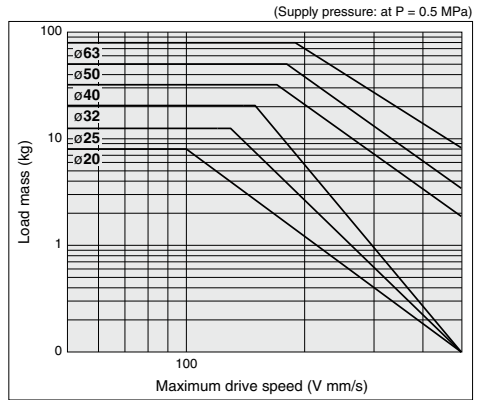
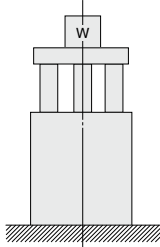

CJ5  
CG5  
HY □  
Water Resistant

**Operating Range When Used as Stopper**

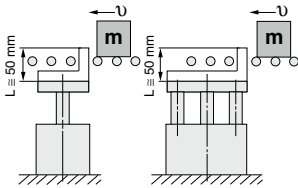

\* When selecting a model with a longer L dimension, be sure to choose a sufficiently large bore size.

**⚠ Caution**  
**Caution on handling**

Note) When using as a stopper  
Bore size ø20 and ø25: Select a model with 30 strokes or less.  
Bore size ø32 to ø63: Select a model with 50 strokes or less.

**Bore size ø20 and ø25**

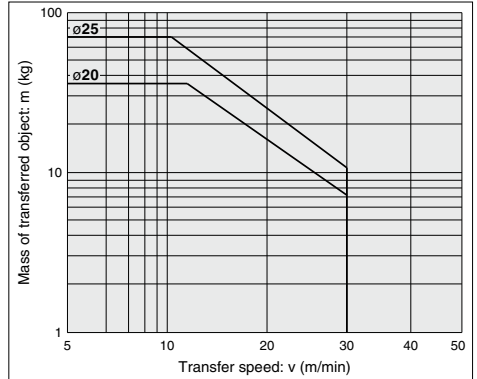

**Bore size ø32 to ø63**

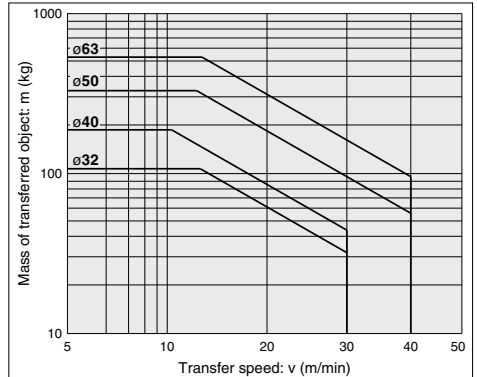

D- □  
-X □  
Technical data

## Construction

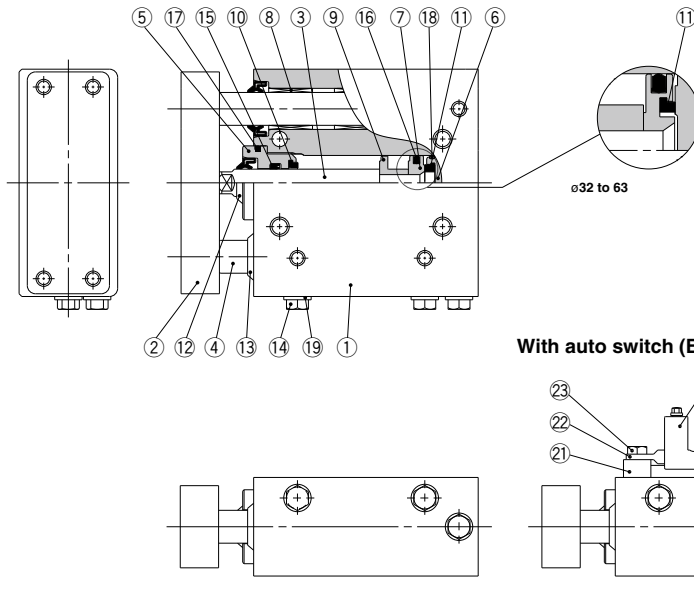

### With auto switch (Built-in magnet type)

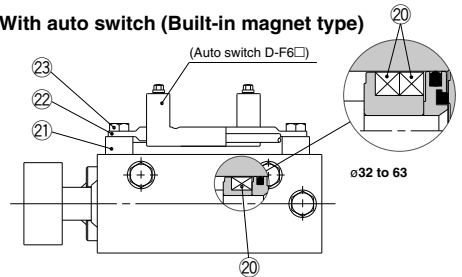

### Component Parts

No.	Description	Material	Qty.	Note
1	Body	Aluminum alloy	1	Anodic oxide film
2	Plate	Aluminum alloy	1	Anodic oxide film
3	Piston rod	Stainless steel	1	Hard chromium plated
4	Guide rod	Stainless steel	2	Special coated
5	Rod cover	Aluminum alloy	1	Anodic oxide film
6	Head cover	Aluminum alloy	1	Chromated
7	Piston	Aluminum alloy	1	Chromated
8	Bushing	Stainless steel	4	Special coated
9	Magnet holder	Aluminum alloy	1	Chromated
10	Bumper A	Resin	1	
11	Bumper B	Resin	1	
12	Scraper (Piston rod)	Stainless steel+NBR	1	(FKM can be selected.)
13	Scraper (Guide rod)	Stainless steel+NBR	2	(FKM can be selected.)
14	Port plug	Stainless steel	3	
15	Rod seal	NBR	1	(FKM can be selected.)
16	Piston seal	NBR	1	
17	O-ring (Rod end)	NBR	1	(FKM can be selected.)
18	O-ring (Head end)	NBR	1	
19	Seal washer	Stainless steel+NBR	3	(FKM can be selected.)
20	Magnet	—	1	(Only built-in magnet) (Over ø32: 2 magnets)
21	Switch rail base	Stainless steel	2	(Only built-in magnet)
22	Switch rail	Stainless steel	1	(Only built-in magnet)
23	Hexagon bolt	Stainless steel	2	(Only built-in magnet)

### Replacement Parts: Seal Kit

Bore size	Part no.	Set contents
20	HYG20□-PS	Set of nos. at left 15, 16, 17 and 19
25	HYG25□-PS	
32	HYG32□-PS	

Place the seal material symbol in □.

Symbol	Material
R	NBR
H	External FKM*

\* External seal: Rod seal, O-ring (Rod side) and seal washer are made from FKM.

\* Seal kit includes 15, 16, 17 and 19. Order the seal kit based on each bore size.

\* Since the seal kit does not include a grease pack, order it separately.

Grease for food part no.: GR-H-010 (10 g)  
Standard grease part no.: GR-S-010 (10 g)

### ⚠ Caution

Please contact SMC to repair or replace seals of cylinder bore size 40 mm and above.

Please contact SMC when the cylinder has to be disassembled for the purpose of replacing seals, etc.

**Dimensions:  $\varnothing 20, \varnothing 25$**

Without auto switch: **HYG20, 25**

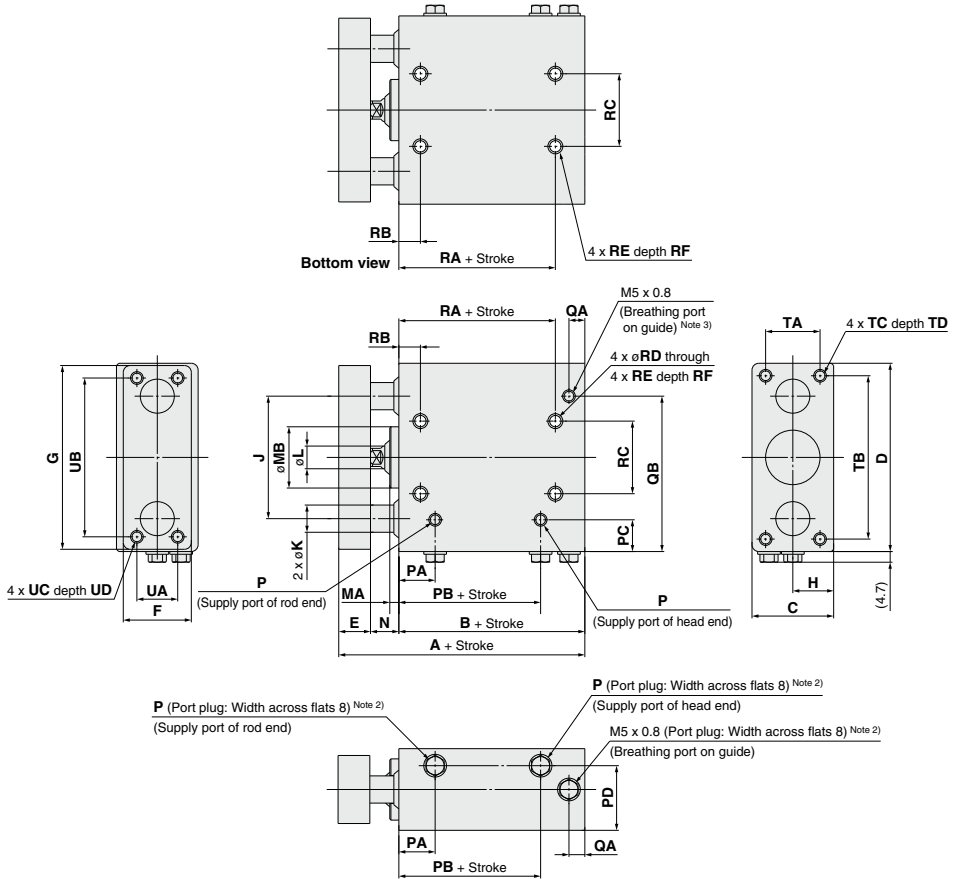

CJ5  
CG5  
**HY**  
Water  
Resistant

Bore size	Standard stroke	A				B				C	D	E	F	G	H	J	K	L	MA	MB	N	P	PA
		30 st or less	31 to 50 st	51 to 100 st	Over 101 st	30 st or less	31 to 50 st	51 to 100 st	Over 101 st														
20	20, 30, 50, 100,	78.5	88.5	108.5	128.5	52	62	82	102	36	83	14	30	81	18	54	12	10	4	27	12.5	M5 x 0.8	16
25	150, 200	86	96	116	136	56.5	66.5	86.5	106.5	42	93	16	38	91	21	64	16	12	4.5	32	13.5	M5 x 0.8	18

Bore size	PB	PC	PD	QA	QB	RA	RB	RC	RD	RE	RF	TA	TB	TC	TD	UA	UB	UC	UD
20	32.5	14	28.5	7	68.5	39	9.5	32	5.4	M6 x 1	12	24	72	M5 x 0.8	13	18	70	M5 x 0.8	10
25	34.5	15	34	8.5	78.5	41.5	9.5	38	5.4	M6 x 1	12	29	80	M6 x 1	14.5	26	78	M6 x 1	12

Note 1) Refer to page 1110 for details about the optional parts (plug bolt).  
 Note 2) The figure above shows the status at shipment (top ported). The side ported can be constructed by changing the port plug position.  
 Note 3) For piping, refer to Specific Product Precautions.

D-  
X-  
Technical  
data

# Series HYG

Dimensions:  $\varnothing 20$ ,  $\varnothing 25$

With auto switch: HYDG20, 25

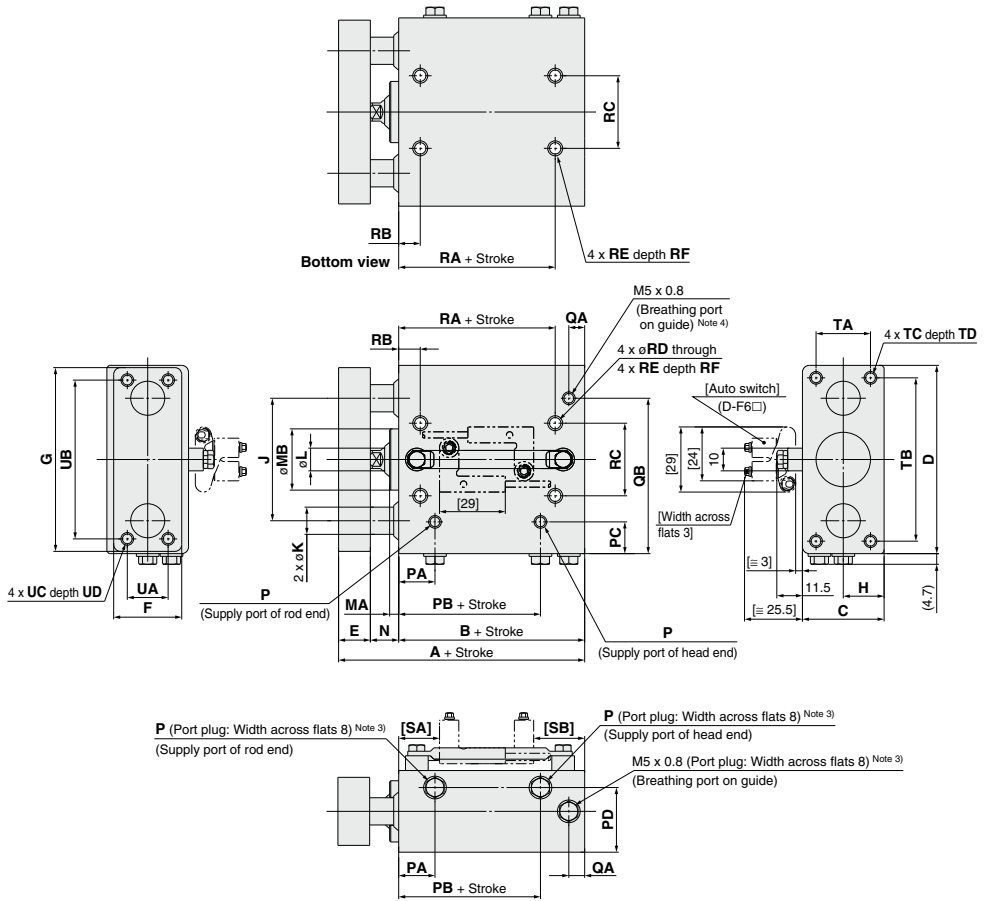

Bore size	Standard stroke	A				B				C	D	E	F	G	H	J	K	L	MA	MB	N	P	PA
		30 st or less	31 to 50 st	51 to 100 st	Over 101 st	30 st or less	31 to 50 st	51 to 100 st	Over 101 st														
20	20, 30, 50, 100,	78.5	88.5	108.5	128.5	52	62	82	102	36	83	14	30	81	18	54	12	10	4	27	12.5	M5 x 0.8	16
25	150, 200	86	96	116	136	56.5	66.5	86.5	106.5	42	93	16	38	91	21	64	16	12	4.5	32	13.5	M5 x 0.8	18

Bore size	PB	PC	PD	QA	QB	RA	RB	RC	RD	RE	RF	SA	SB				TA	TB	TC	TD	UA	UB	UC	UD
													30 st or less	31 to 50 st	51 to 100 st	Over 101 st								
20	32.5	14	28.5	7	68.5	39	9.5	32	5.4	M6 x 1	12	16	22.5	32.5	52.5	72.5	24	72	M5 x 0.8	13	18	70	M5 x 0.8	10
25	34.5	15	34	8.5	78.5	41.5	9.5	38	5.4	M6 x 1	12	17	25.5	35.5	55.5	75.5	29	80	M6 x 1	14.5	26	78	M6 x 1	12

Note 1) The [ ] value denotes dimensions with the auto switch D-F6□ mounted, which is dedicated to the Hygienic Design Cylinder.

Note 2) Refer to page 1110 for details about the optional parts (plug bolt).

Note 3) The figure above shows the status at shipment (top ported). The side ported can be constructed by changing the port plug position.

Note 4) For piping, refer to Specific Product Precautions.

**Dimensions:  $\varnothing 32$  to  $\varnothing 63$**

Without auto switch: HYG32 to 63

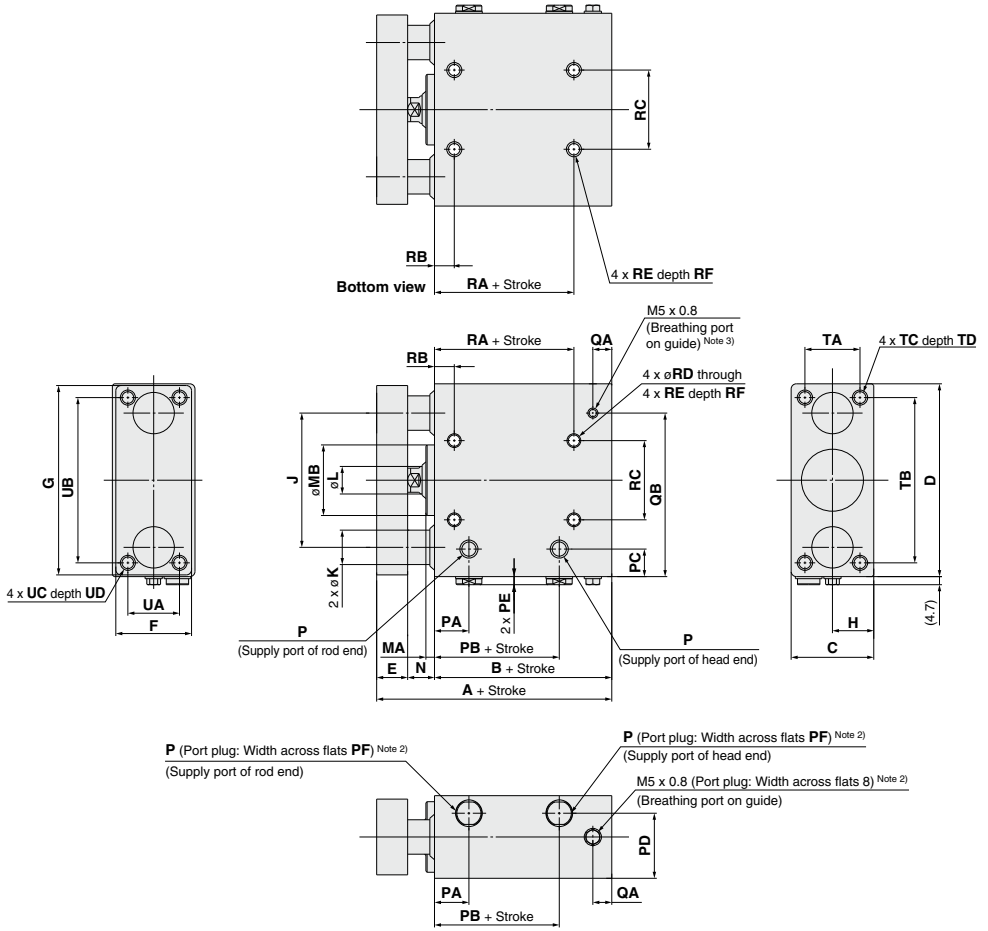

CJ5  
CG5  
HYG  
Water Resistant

Bore size	Stroke	A				B				C	D	E	F	G	H	J	K	L	MA	MB	N
		25 st or less	26 to 50 st	51 to 100 st	Over 101 st	25 st or less	26 to 50 st	51 to 100 st	Over 101 st												
32	25, 50, 100, 150, 200	106.5	116.5	131.5	146.5	73	83	98	113	48	112	18	44	110	24	78	20	16	5	41	15.5
40		106.5	116.5	131.5	146.5	73	83	98	113	54	120	18	44	118	27	86	20	16	5	48	15.5
50		121.5	131.5	146.5	161.5	80	90	105	120	64	148	23	60	146	32	110	25	20	6	59	18.5
63		121.5	131.5	146.5	161.5	80	90	105	120	78	162	23	70	158	39	124	25	20	6	74	18.5

Bore size	P			PA	PB	PC	PD	PE	PF	QA	QB	RA	RB	RC	RD	RE	RF	TA	TB	TC	TD	UA	UB	UC	UD
	Nil	TF	TN																						
32	Rc 1/8	G 1/8	NPT 1/8	20	42.5	16	37.8	4.7	13	11	95	51	11.5	46	6.6	M8 x 1.25	16	32	96	M8 x 1.25	20	30	96	M8 x 1.25	13.5
40	Rc 1/8	G 1/8	NPT 1/8	20.5	40.5	17	42.5	4.7	13	11	103	31	30	50	6.6	M8 x 1.25	16	38	104	M8 x 1.25	20	30	104	M8 x 1.25	13.5
50	Rc 1/4	G 1/4	NPT 1/4	22	41.5	22	52	6.2	16	12.5	129	31	32	63	8.6	M10 x 1.5	20	43	127	M10 x 1.5	22	40	130	M10 x 1.5	17
63	Rc 1/4	G 1/4	NPT 1/4	24	45	23	61	6.2	16	12	143	35	34	76	8.6	M10 x 1.5	20	57	141	M10 x 1.5	22	50	130	M10 x 1.5	17

Note 1) Refer to page 1110 for details about the optional parts (plug bolt).  
 Note 2) The figure above shows the status at shipment (top ported). The side ported can be constructed by changing the port plug position.  
 Note 3) For piping, refer to Specific Product Precautions.

D-□  
-X□  
Technical data

# Series HYG

## Dimensions: $\varnothing 32$ to $\varnothing 63$

With auto switch: HYDG32 to 63

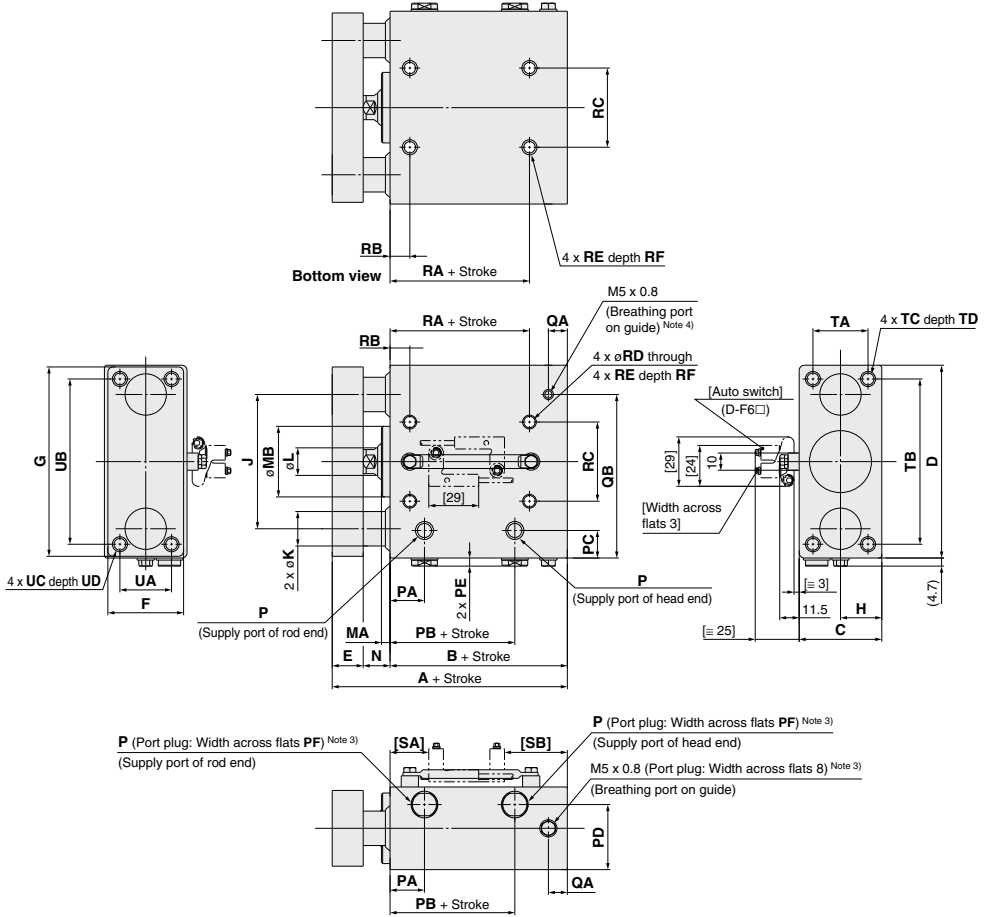

Bore size	Stroke	A												B				C	D	E	F	G	H	J	K	L	MA	MB	N	P			PA
		25 st or less	26 to 50 st	51 to 100 st	Over 101 st	25 st or less	26 to 50 st	51 to 100 st	Over 101 st	NI	TF	TN																					
		32	40	50	63	32	40	50	63	Rc 1/8	G 1/8	NPT 1/8																					
	25, 50, 100, 150, 200	106.5	116.5	131.5	146.5	73	83	98	113	48	112	18	44	110	24	78	20	16	5	41	15.5	Rc 1/8	G 1/8	NPT 1/8	20								
		121.5	131.5	146.5	161.5	80	90	105	120	64	148	23	60	146	32	110	25	20	6	59	18.5	Rc 1/4	G 1/4	NPT 1/4	22								
		121.5	131.5	146.5	161.5	80	90	105	120	78	162	23	70	158	39	124	25	20	6	74	18.5	Rc 1/4	G 1/4	NPT 1/4	24								

Bore size	PB	PC	PD	PE	PF	QA	QB	RA	RB	RC	RD	RE	RF	SA	SB				TA	TB	TC	TD	UA	UB	UC	UD
															25 st or less	26 to 50 st	51 to 100 st	Over 101 st								
32	42.5	16	37.8	4.7	13	11	95	51	11.5	46	6.6	M8 x 1.25	16	22.5	36.5	46.5	61.5	76.5	32	96	M8 x 1.25	20	30	96	M8 x 1.25	13.5
40	40.5	17	42.5	4.7	13	11	103	31	30	50	6.6	M8 x 1.25	16	21	38	48	63	78	38	104	M8 x 1.25	20	30	104	M8 x 1.25	13.5
50	41.5	22	52	6.2	16	12.5	129	31	32	63	8.6	M10 x 1.5	20	21	45	55	70	85	43	127	M10 x 1.5	22	40	130	M10 x 1.5	17
63	45	23	61	6.2	16	12	143	35	34	76	8.6	M10 x 1.5	20	23.5	42.5	52.5	67.5	82.5	57	141	M10 x 1.5	22	50	130	M10 x 1.5	17

Note 1) The [ ] value denotes dimensions with the auto switch D-F6□ mounted, which is dedicated to the Hygienic Design Cylinder.

Note 2) Refer to page 1110 for details about the optional parts (plug bolt).

Note 3) The figure above shows the status at shipment (top ported). The side ported can be constructed by changing the port plug position.

Note 4) For piping, refer to Specific Product Precautions.



Series **HY** □

# Auto Switch Mounting 1

## Auto Switch Proper Mounting Position (Detection at stroke end) and Its Mounting Height

**HYB**

**D-H7BA**

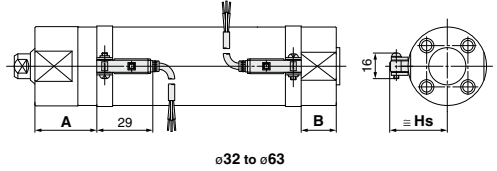
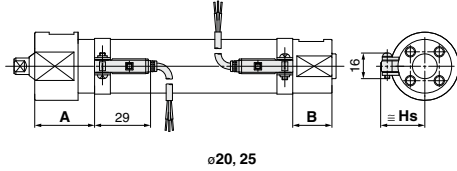

**D-G5BA**

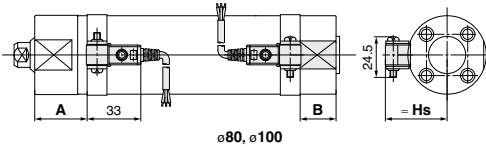

**CJ5**  
**CG5**

**HY** □

Water  
Resistant

Bore size	D-H7BA			D-G5BA		
	A	B	Hs	A	B	Hs
20	29	19.5	24.5	—	—	—
25	29	19.5	27	—	—	—
32	30	20.5	30.5	—	—	—
40	34.5	22.5	35	—	—	—
50	42	27.5	40.5	—	—	—
63	42	27.5	47.5	—	—	—
80	—	—	—	48	32	59
100	—	—	—	48	32	69.5

Note) The above values are a guide in the stroke end detection of the mounting position of the auto switch. Please adjust in an actual setting after confirming the operating state of the auto switch.

## Operating Range

Auto switch model	Bore size							
	20	25	32	40	50	63	80	100
D-H7BA	4	4	4.5	5	6	6.5	—	—
D-G5BA	—	—	—	—	—	—	6.5	7

\* Since this is a guideline including hysteresis, it is not meant to be guaranteed. There may be substantial variation depending on the surrounding environment (assuming approximately ±30% dispersion).

## Minimum Stroke of Auto Switch Mounting

Auto switch model	1 pc.	2 pcs.
D-H7BA	10	15
D-G5BA	10	15

## Auto Switch Mounting Bracket/Part No.

Auto switch model	Bore size (mm)							
	20	25	32	40	50	63	80	100
D-H7BA	BMA2-020AS	BMA2-025AS	BMA2-032AS	BMA2-040AS	BMA2-050AS	BMA2-063AS	—	—
D-G5BA	—	—	—	—	—	—	BA-08	BA-10

\* When the auto switch bracket above is ordered as a single unit, steel screws are included. When assembling, use the stainless steel screws attached to the auto switches shown below.  
Stainless steel mounting screw kit

BBA3: for D-G5BA

• The D-G5BA auto switch is set on the cylinder with the stainless steel screws above when shipped. When an auto switch is shipped independently, BBA3 is attached.

Note 1) Refer to pages 1655 and 1656 for the details of BBA3.

Note 2) The stainless steel screws supplied with the D-H7BA auto switch cannot be used.

• Refer to pages 1655 and 1656 for auto switch mounting.

**D** □

**-X** □

Technical  
data

# Auto Switch Mounting 2

## Auto Switch Proper Mounting Position (Detection at stroke end) and Its Mounting Height

### Series HYQ

D-F6□

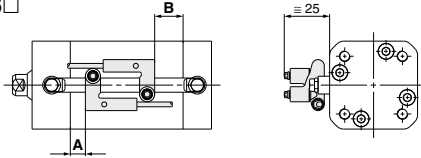

Bore size	(mm)	
	A	B
20	6.5	10.5
25	6.5	11
32	8.5	16
40	10.5	16
50	10.5	17
63	9	18

Note) The above values are a guide in the stroke end detection of the mounting position of the auto switch. Please adjust in an actual setting after confirming the operating state of the auto switch.

### Series HYC

D-F6□

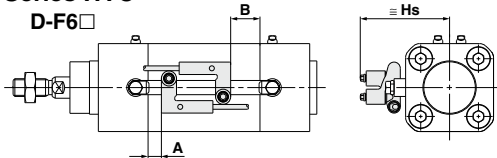

Bore size	(mm)		
	A	B	Hs
32	7.5	16.5	50
40	12	23	54
50	9	19	60
63	19	24	67

Note) The above values are a guide in the stroke end detection of the mounting position of the auto switch. Please adjust in an actual setting after confirming the operating state of the auto switch.

### Series HYG

D-F6□

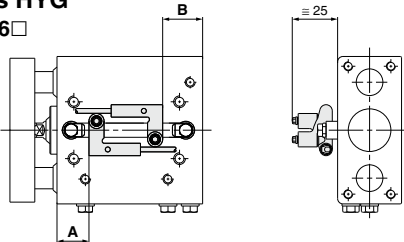

Bore size	A	(mm)			
		B			
		30 st or less	31 to 50 st	51 to 100 st	Over 101 st
20	16	22.5	32.5	52.5	72.5
25	17	25.5	35.5	55.5	75.5
32	22.5	36.5	46.5	61.5	76.5
40	21	38	48	63	78
50	21	45	55	70	85
63	23.5	42.5	52.5	67.5	82.5

Note) The above values are a guide in the stroke end detection of the mounting position of the auto switch. Please adjust in an actual setting after confirming the operating state of the auto switch.

## Operating Range

Unit: Operating range [mm]

Auto switch model	Series	Bore size					
		20	25	32	40	50	63
D-F6□	HYQ	7	6	7.5	7.5	7.5	7.5
	HYC	—	—	7.5	7.5	7.5	7.5
	HYG	7	7	8	7.5	7.5	7.5

Note) Since this is a guideline including hysteresis, it is not meant to be guaranteed. There may be substantial variation depending on the surrounding environment (assuming approximately ±30% dispersion).

## Minimum Stroke of Auto Switch Mounting

Auto switch model	Series	1 pc.	2 pcs.
D-F6□	HYQ, HYC	5	10
	HYG	10	15

## Auto Switch Mounting (HYQ, HYC, HYG common)

### Proper tightening torque

When the mounting screw is tightened, use a special tool (D-F6B-650) or torque wrench.

The tightening torque of the M3 mounting screw should be 0.8 to 1.4 N·m.

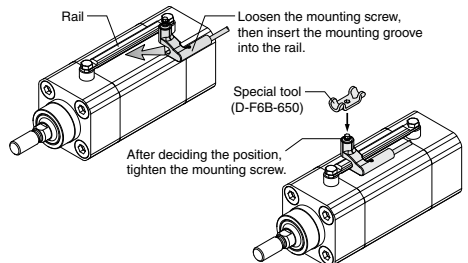

Tighten the screw within the following torque range when the auto switch mounting rail is installed during maintenance.

Screw size	Tightening torque (N·m)
M4	1.1 to 1.9

Tighten the screw within the following torque range when the auto switch is installed on the mounting rail.

Tightening torque (N·m)
0.8 to 1.4

# Mounting Brackets

## Foot Bracket

### Series HYB

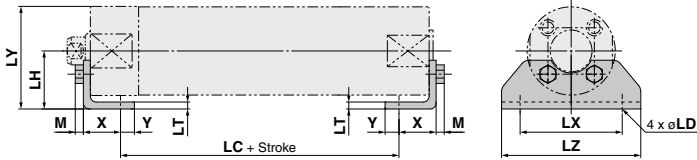

Foot bracket material: Stainless steel  
Mounting bolt material: Stainless steel (mm)

Bore size	Bracket part no.	Weight (kg)	X	Y	LD	LH	LC	LT	LX	LY	LZ	M	Mounting bolt
32	CG-L032SUS	0.06	16	6	7.2	25	45	3	44	44	60	3.5	M5 x 0.8
40	CG-L040SUS	0.08	16.5	6.5	7.2	30	51	3	54	53.5	75	4	M6 x 1.0
50	CG-L050SUS	0.17	21.5	11.5	10	40	55	4	66	69	90	5.5	M8 x 1.25
63	CG-L063SUS	0.23	21.5	11.5	12	45	55	4	82	81	110	7	M10 x 1.5
80	CG-L080SUS	0.36	28	17	12	55	60	4	100	99.5	130	7	M10 x 1.5
100	CG-L100SUS	0.69	30	15	14	70	60	6	120	125	160	8	M12 x 1.75

Note 1) Order two foot brackets per cylinder. One mounting bracket is attached with two foot brackets and four mounting bolts.  
Note 2) Contact SMC for HYB ø20, ø25.

### Series HYC

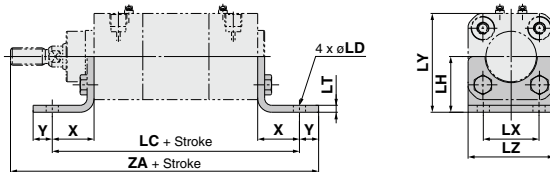

### Series HYQ

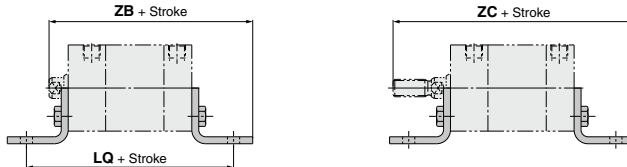

Foot bracket material: Stainless steel  
Mounting bolt material: Stainless steel (mm)

Bore size	Bracket part no.	Weight (g)	X	Y	LD	LH	LC	LQ	LT	LX	LY	LZ	HYC		HYQ Without auto switch		HYDQ With auto switch		Mounting bolt
													ZA	ZB	ZC	ZB	ZC		
32	HY-L032SUS	100	24	11	7	32	142	109	4	32	57	49.5	177	107	129	122	144	M6 x 1 x 18L	
40	HY-L040SUS	120	28	10	9	36	161	121.5	4	36	65	57.5	198	115.5	139.5	130.5	154.5	M6 x 1 x 18L	
50	HY-L050SUS	210	32	11	9	45	170	140.5	5	45	80	69	218	133.5	165.5	148.5	180.5	M8 x 1.25 x 20L	
63	HY-L063SUS	260	32	11	9	50	185	141	5	50	92	84	233	134	166	149	181	M8 x 1.25 x 20L	

Note 1) One mounting bracket is attached with one foot bracket and two mounting bolts.  
Note 2) Two foot brackets per cylinder should be ordered.  
Note 3) Contact SMC for HYQ ø20, ø25.

CJ5  
CG5

HY□

Water  
Resistant

D-□

-X□

Technical  
data

## Flange Bracket

### Series HYB (Rod end)

Rod end flange bracket (Material: Stainless steel)

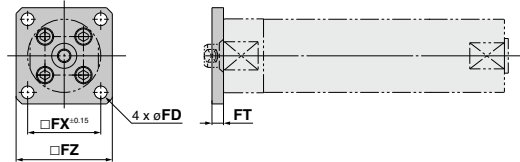

Flange bracket material: Stainless steel  
Mounting bolt material: Stainless steel  
(mm)

Bore size	Bracket part no.	Weight (kg)	FT	FX	FZ	FD
32	CG-F032SUS	0.10	6	38	50	6.6
40	CG-F040SUS	0.15	6	46	60	6.6
50	CG-F050SUS	0.26	9	58	75	9
63	CG-F063SUS	0.52	9	70	90	11
80	CG-F080SUS	0.66	9	82	100	11
100	CG-F100SUS	1.16	10	100	125	14

Note 1) One mounting bracket is attached with one flange bracket and four mounting bolts.  
Note 2) Contact SMC for HYB ø20, ø25.

### Series HYC (Rod end and head end are common.)

### Series HYQ (Rod end and head end are common.)

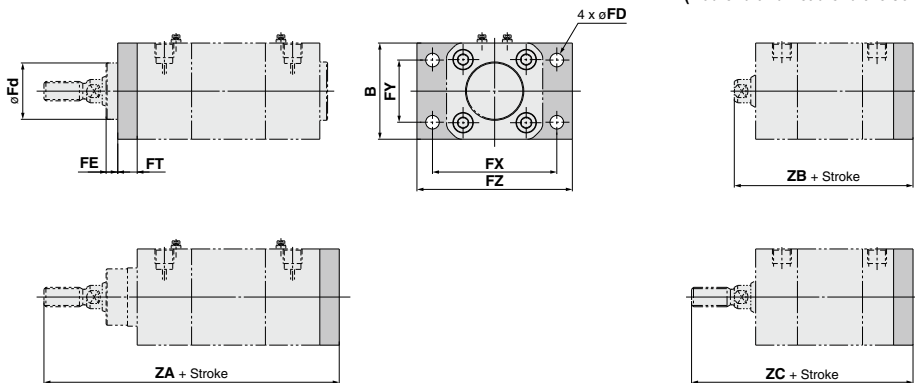

Flange bracket material: Stainless steel  
Mounting bolt material: Stainless steel  
(mm)

Bore size	Bracket part no.	Weight (g)	B	FD	FE	FT	FX	FY	FZ	Fd	HYC	HYQ		HYDQ		Mounting bolt
												Without auto switch	With auto switch	Without auto switch	With auto switch	
											ZA	ZB	ZC	ZB	ZC	
32	HY-F032SUS	260	49.5	7	6	10	64	32	80	29	152	82	104	97	119	M6 x 1 x 18L
40	HY-F040SUS	320	57.5	9	8.5	10	72	36	90	34	169	87.5	111.5	102.5	126.5	M6 x 1 x 18L
50	HY-F050SUS	580	69	9	11	12	90	45	110	39	187	102.5	134.5	117.5	149.5	M8 x 1.25 x 20L
63	HY-F063SUS	770	82	9	11	12	100	50	120	44	202	103	135	118	150	M8 x 1.25 x 20L

Note 1) One mounting bracket is attached with 4 mounting bolts.  
Note 2) Contact SMC for HYQ ø20, ø25.

## Single Clevis Bracket

### Series HYC

Single clevis bracket material: Stainless steel  
Mounting bolt material: Stainless steel (mm)

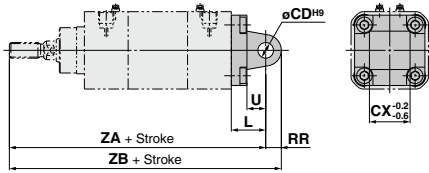

Bore size	Bracket part no.	Weight (g)	L	RR	U	CD <sup>H9</sup>	CX <sup>-0.2/-0.6</sup>	HYC	
								ZA	ZB
32	HY-C032SUS	200	22	10	12	10	26	164	174
40	HY-C040SUS	310	25	12	15	12	28	184	196
50	HY-C050SUS	440	27	12	17	12	32	202	214
63	HY-C063SUS	760	32	16	20	16	40	222	238

CJ5  
CG5

HY □

Water Resistant

### Series HYQ

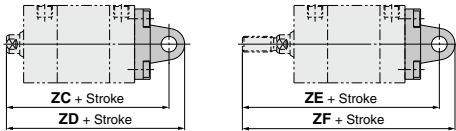

Bore size	Bracket part no.	HYQ / without auto switch			
		ZC	ZD	ZE	ZF
32	HY-C032SUS	94	104	116	126
40	HY-C040SUS	102.5	114.5	126.5	138.5
50	HY-C050SUS	117.5	129.5	149.5	161.5
63	HY-C063SUS	123	139	155	171

Bore size	Bracket part no.	HYDQ / with auto switch				Mounting bolt
		ZC	ZD	ZE	ZF	
32	HY-C032SUS	109	119	131	141	M6 x 1 x 18L
40	HY-C040SUS	117.5	129.5	141.5	153.5	M6 x 1 x 18L
50	HY-C050SUS	132.5	144.5	164.5	176.5	M8 x 1.25 x 20L
63	HY-C063SUS	138	154	170	186	M8 x 1.25 x 20L

Note 1) One mounting bracket is attached with 4 mounting bolts.  
Note 2) Contact SMC for HYQ ø20, ø25.

## Double Clevis Bracket

### Series HYC

Double clevis bracket material: Stainless steel  
Mounting bolt material: Stainless steel (mm)

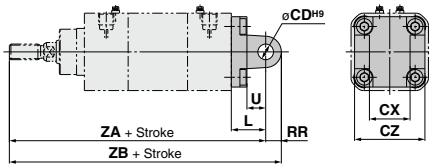

Bore size	Bracket part no.	Weight (g)	L	RR	U	CD <sup>H9</sup>	CX <sup>H14</sup>	CZ <sup>H14</sup>
40	HY-D040SUS	350	25	12	15	12	28	52
50	HY-D050SUS	490	27	12	17	12	32	60
63	HY-D063SUS	810	32	16	20	16	40	70

Bore size	Bracket part no.	HYC		HYQ / without auto switch			
		ZA	ZB	ZC	ZD	ZE	ZF
32	HY-D032SUS	164	174	94	104	116	126
40	HY-D040SUS	184	196	102.5	114.5	126.5	138.5
50	HY-D050SUS	202	214	117.5	129.5	149.5	161.5
63	HY-D063SUS	222	238	123	139	155	171

### Series HYQ

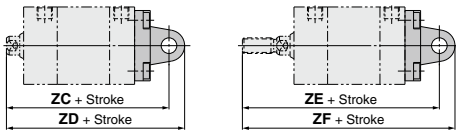

Bore size	Bracket part no.	HYDQ / with auto switch				Mounting bolt
		ZC	ZD	ZE	ZF	
32	HY-D032SUS	109	119	131	141	M6 x 1 x 18L
40	HY-D040SUS	117.5	129.5	141.5	153.5	M6 x 1 x 18L
50	HY-D050SUS	132.5	144.5	164.5	176.5	M8 x 1.25 x 20L
63	HY-D063SUS	138	154	170	186	M8 x 1.25 x 20L

Note 1) One mounting bracket is attached with 4 mounting bolts and clevis pin (HY-E0□SUS) and retaining rings.  
Note 2) Contact SMC for HYQ ø20, ø25.

## Clevis Pin

Pin material: Stainless steel  
Retaining ring material: Stainless steel (mm)

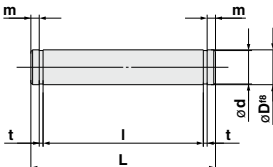

Bore size	Bracket part no.	Weight (g)	D <sup>1/8</sup>	L	d	l	m	t	Applied retaining ring
40	HY-E04SUS	60	12	60	11.5	53	2.3	1.2	C type for shaft 12
50	HY-E05SUS	70	12	68	11.5	61	2.3	1.2	C type for shaft 12
63	HY-E06SUS	130	16	78	15.2	71	2.3	1.2	C type for shaft 16

Note 1) One clevis pin is attached with two retaining rings.  
Note 2) Contact SMC for HYQ ø20, ø25.

D-□

-X□

Technical data

# Options

## Rod End Nut

### Series HYQ, HYC

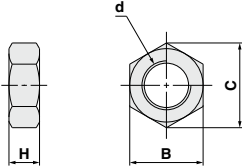

Material: Stainless steel  
(mm)

Part no.	Applicable bore size	d	H	B	C
NTH-02SUS	20	M6 x 1.0	3.6	10	11.5
NT-02SUS	25	M8 x 1.25	5	13	15
NT-03SUS	32	M10 x 1.25	6	17	19.6
NTH-04SUS	40	M12 x 1.25	7	19	21.9
NTH-05SUS	50, 63	M16 x 1.5	10	24	27.7

## Plug Bolt

Plug bolts are used to close the mounting hole not used.

### Series HYC

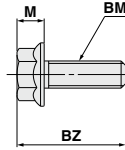
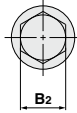

Material: Stainless steel  
(mm)

Part no.	Applicable bore size	B2	BM	BZ	M
HYC-H03SUS	32, 40	10	M6 x 1.0	22	6
HYC-H05SUS	50, 63	12	M8 x 1.25	24	8

Note) The above part number is attached with 4 bolts.

### Series HYB, HYG

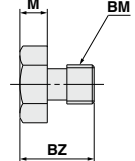
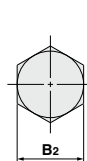

Material: Stainless steel  
(mm)

#### HYB

Part no.	Applicable bore size	B2	BM	BZ	M
HYB-H020SUS	20	7	M4 x 0.7	9	3
HYB-H025SUS	25	8	M5 x 0.8	9.5	3.5
HYB-H025SUS	32	8	M5 x 0.8	9.5	3.5
HYB-H040SUS	40	10	M6 x 1.0	12	4
HYB-H050SUS	50	13	M8 x 1.25	15.5	5.5
HYB-H063SUS	63	17	M10 x 1.5	19	7
HYB-H063SUS	80	17	M10 x 1.5	19	7
HYB-H100SUS	100	19	M12 x 1.75	24	8

Note) The above part number is attached with 4 bolts.

#### HYG

Part no.	B2	BM	BZ	M
HYG-H020SUS	8	M5 x 0.8	9.5	3.5
HYG-H025SUS	10	M6 x 1.0	12	4
HYG-H032SUS	13	M8 x 1.25	15.5	5.5
HYG-H050SUS	17	M10 x 1.5	19	7

Note) The above part number is attached with 4 bolts.

## External Cover

### Series HYQ/ø20, ø25

#### Rod end

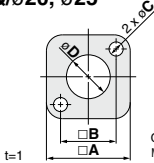

Cover material: Stainless steel  
Mounting bolt material: Stainless steel  
(mm)

Part no.	A	B	C	D	Installation bolt
HYQ-HA020SUS	32.2	22	5.5	18.5	M5 x 0.8 x 10L
HYQ-HA025SUS	39.2	26	6.6	20.5	M6 x 1.0 x 10L

Note) One mounting bracket is attached with two mounting bolts.

#### Head end

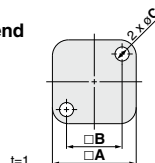

Cover material: Stainless steel  
Mounting bolt material: Stainless steel  
(mm)

Part no.	A	B	C	Installation bolt
HYQ-HB020SUS	32.2	22	5.5	M5 x 0.8 x 10L
HYQ-HB025SUS	39.2	26	6.6	M6 x 1.0 x 10L

Note) One mounting bracket is attached with two mounting bolts.

### Series HYQ/ø32 to ø63

#### Rod end

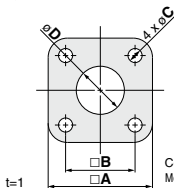

Cover material: Stainless steel  
Mounting bolt material: Stainless steel  
(mm)

Part no.	A	B	C	D	Installation bolt
HYQ-HA032SUS	48.8	32.5	6.6	22.5	M6 x 1.0 x 10L
HYQ-HA040SUS	56.8	38	6.6	26.5	M6 x 1.0 x 10L
HYQ-HA050SUS	68.2	46.5	8.8	32.5	M8 x 1.25 x 10L
HYQ-HA063SUS	83.2	56.5	8.8	32.5	M8 x 1.25 x 10L

Note) One mounting bracket is attached with four mounting bolts.

#### Head end

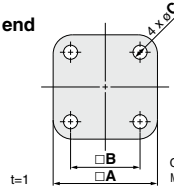

Cover material: Stainless steel  
Mounting bolt material: Stainless steel  
(mm)

Part no.	A	B	C	Installation bolt
HYQ-HB032SUS	48.8	32.5	6.6	M6 x 1.0 x 10L
HYQ-HB040SUS	56.8	38	6.6	M6 x 1.0 x 10L
HYQ-HB050SUS	68.2	46.5	8.8	M8 x 1.25 x 10L
HYQ-HB063SUS	83.2	56.5	8.8	M8 x 1.25 x 10L

Note) One mounting bracket is attached with four mounting bolts.

**Mounting Bolts for HYQB and HYDQB**

**Mounting method** : Mounting bolts for HYQB and HYDQB with through-holes are available.

**How to Order** : Add "HY-" to the head of the bolt.

**Example)** Prepare the mounting bolt of cylinder model "HYQB20-5".  
The part no. is "HY-M4 x 65L" 2 pcs.

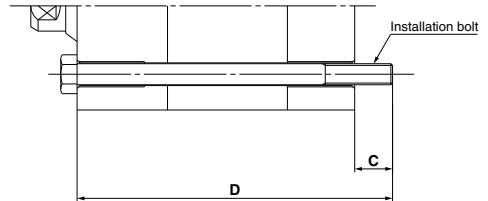

**CJ5**  
**CG5**  
**HY**   
Water  
Resistant

**HYQ/Without built-in magnet**

Cylinder model	C	D	Mounting bolt part no.
<b>HYQB20-5</b>	10	65	HY-M4 x 65L
-10		70	x 70L
-15		75	x 75L
-20		80	x 80L
-25		85	x 85L
-30		90	x 90L
-35		95	x 95L
-40		100	x 100L
-45		105	x 105L
-50		110	x 110L
<b>HYQB25-5</b>	9	65	HY-M5 x 65L
-10		70	x 70L
-15		75	x 75L
-20		80	x 80L
-25		85	x 85L
-30		90	x 90L
-35		95	x 95L
-40		100	x 100L
-45		105	x 105L
-50		110	x 110L

Cylinder model	C	D	Mounting bolt part no.
<b>HYQB32-5</b>	9	75	HY-M5 x 75L
-10		80	x 80L
-15		85	x 85L
-20		90	x 90L
-25		95	x 95L
-30		100	x 100L
-35		105	x 105L
-40		110	x 110L
-45		115	x 115L
-50		120	x 120L
-75	145	x 145L	
-100	170	x 170L	
<b>HYQB40-5</b>	9.5	80	HY-M5 x 80L
-10		85	x 85L
-15		90	x 90L
-20		95	x 95L
-25		100	x 100L
-30		105	x 105L
-35		110	x 110L
-40		115	x 115L
-45		120	x 120L
-50		125	x 125L
-75	150	x 150L	
-100	175	x 175L	

Cylinder model	C	D	Mounting bolt part no.
<b>HYQB50-10</b>	13.5	100	HY-M6 x 100L
-15		105	x 105L
-20		110	x 110L
-25		115	x 115L
-30		120	x 120L
-35		125	x 125L
-40		130	x 130L
-45		135	x 135L
-50		140	x 140L
-75		165	x 165L
-100	190	x 190L	
<b>HYQB63-10</b>	13	100	HY-M6 x 100L
-15		105	x 105L
-20		110	x 110L
-25		115	x 115L
-30		120	x 120L
-35		125	x 125L
-40		130	x 130L
-45		135	x 135L
-50		140	x 140L
-75		165	x 165L
-100	190	x 190L	

Material: Stainless steel

**HYDQ/With built-in magnet**

Cylinder model	C	D	Mounting bolt part no.
<b>HYDQB20-5</b>	10	75	HY-M4 x 75L
-10		80	x 80L
-15		85	x 85L
-20		90	x 90L
-25		95	x 95L
-30		100	x 100L
-35		105	x 105L
-40		110	x 110L
-45		115	x 115L
-50		120	x 120L
<b>HYDQB25-5</b>	9	75	HY-M5 x 75L
-10		80	x 80L
-15		85	x 85L
-20		90	x 90L
-25		95	x 95L
-30		100	x 100L
-35		105	x 105L
-40		110	x 110L
-45		115	x 115L
-50		120	x 120L

Cylinder model	C	D	Mounting bolt part no.
<b>HYDQB32-5</b>	9	90	HY-M5 x 90L
-10		95	x 95L
-15		100	x 100L
-20		105	x 105L
-25		110	x 110L
-30		115	x 115L
-35		120	x 120L
-40		125	x 125L
-45		130	x 130L
-50		135	x 135L
-75	160	x 160L	
-100	185	x 185L	
<b>HYDQB40-5</b>	9.5	95	HY-M5 x 95L
-10		100	x 100L
-15		105	x 105L
-20		110	x 110L
-25		115	x 115L
-30		120	x 120L
-35		125	x 125L
-40		130	x 130L
-45		135	x 135L
-50		140	x 140L
-75	165	x 165L	
-100	190	x 190L	

Cylinder model	C	D	Mounting bolt part no.
<b>HYDQB50-10</b>	13.5	115	HY-M6 x 115L
-15		120	x 120L
-20		125	x 125L
-25		130	x 130L
-30		135	x 135L
-35		140	x 140L
-40		145	x 145L
-45		150	x 150L
-50		155	x 155L
-75		180	x 180L
-100	205	x 205L	
<b>HYDQB63-10</b>	13	115	HY-M6 x 115L
-15		120	x 120L
-20		125	x 125L
-25		130	x 130L
-30		135	x 135L
-35		140	x 140L
-40		145	x 145L
-45		150	x 150L
-50		155	x 155L
-75		180	x 180L
-100	205	x 205L	

**D**   
**-X**   
Technical  
data



## Series HY □

# Specific Product Precautions 1

Be sure to read before handling. Refer to front matter 57 for Safety Instructions and pages 3 to 12 for Actuator and Auto Switch Precautions.

### Caution on Design

#### ⚠ Caution

1. Speed adjustment should be conducted in the environment where the cylinder is used.

In a different environment, the speed adjustment may be incorrect.

2. There are possibilities that dust may accumulate by the usage condition in the thread part and brackets for mounting of this products.

Do measures according to the usage condition when you mount it.

### Operating Environment

#### ⚠ Caution

1. Avoid installing and using a cylinder inside a food zone.

<Not installable>

Food zone ..... An environment where food which will be sold as merchandize, directly touches the cylinder's components.

<Installable>

Splash zone ..... An environment where food which will not be sold as merchandize, directly touches the cylinder's components.

Non-food zone ..... An environment where there is no contact with food.

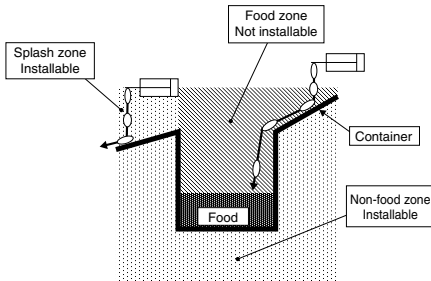

2. When a detergent or chemical liquid other than water is splashed on the cylinder, the cylinder's service life may be substantially shortened. Please contact us for details.

3. When washing a cylinder with steam, please observe the allowable temperature range of the cylinder and perform for a short period of time.

4. When washing a cylinder with a brush, etc., please do not apply excessive force to the auto switch's lead wire, etc.

### Mounting

#### ⚠ Warning

1. Do not put hands or fingers, etc. between the plate and body. [Series HYG]

Care should be taken that hands or fingers do not get caught in between the cylinder body and the plate when air pressure is applied.

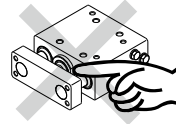

#### ⚠ Caution

1. Design the aptitude enough by thinking about the rigidity of mount because the cylinder puts out big power.

2. Tighten in following tightening torque when you install the auto switch rail when repairing it.

[Series HYC and HYQ]

Thread size	Tightening torque (N·m)
M4	1.1 to 1.9

3. Do not apply any force to lead wires when auto switch is mounted on cylinder.

Never apply any force to lead wires. This may not only cause broken lead wires, but it may cause internal elements of the switch to be damaged by the stress. Moreover, the switch might not operate when force applies to the lead wire and the distance between the switch and the cylinder become long.

4. Pay attention to magnetic substance density between the auto switch and the cylinder body and the circumference.

When a magnetic substance is brought into close proximity with an auto switch and cylinder, it may cause the auto switch to malfunction due to a loss of the magnetic force inside the cylinder.

5. When the cylinder, the support bracket and the plug bolt are mounted, tighten them within below tightening torque.

[Series HYB]

Bore size	Thread size	Tightening torque (N·m)
ø20	M4 x 0.7	1.1 to 1.9
ø25, ø32	M5 x 0.8	2.1 to 3.9
ø40	M6 x 1	3.7 to 6.7
ø50	M8 x 1.25	8.8 to 16.2
ø63, ø80	M10 x 1.5	17.2 to 31.8
ø100	M12 x 1.75	29.4 to 54.6

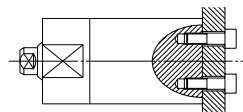





# Series HY

## Specific Product Precautions 2

Be sure to read before handling. Refer to front matter 57 for Safety Instructions and pages 3 to 12 for Actuator and Auto Switch Precautions.

### Mounting

#### Caution

[Series HYC]

Bore size	Thread size	Tightening torque (N·m)
ø32, 40	M6 x 1	3.7 to 6.7
ø50, 63	M8 x 1.25	8.8 to 16.2

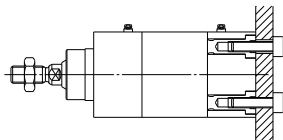

6. When the cylinder, the support bracket and the external cover are mounted, tighten them within below tightening torque. [Series HYQ]

Bore size	Thread size	Tightening torque (N·m)
ø20	M5 x 0.8	2.1 to 3.9
ø25, 32, 40	M6 x 1	3.7 to 6.7
ø50, 63	M8 x 1.25	8.8 to 16.2

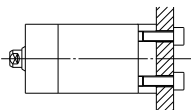

7. When the cylinder, the plug bolt and the load are mounted, tighten within below tightening torque. [Series HYG]

Top Mounting

Bore size	Thread size	Tightening torque (N·m)
ø20, 25	M5 x 0.8	2.1 to 3.9
ø32, 40	M6 x 1	3.7 to 6.7
ø50, 63	M8 x 1.25	8.8 to 16.2

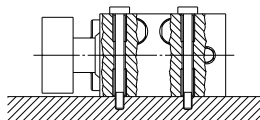

Lower Side Mounting

Bore size	Thread size	Tightening torque (N·m)
ø20, 25	M6 x 1	3.7 to 6.7
ø32, 40	M8 x 1.25	8.8 to 16.2
ø50, 63	M10 x 1.5	17.2 to 31.8

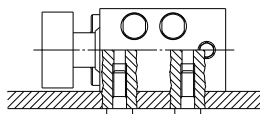

#### Caution

Bottom Mounting or Load Mounting

Bore size	Thread size	Tightening torque (N·m)
ø20	M5 x 0.8	2.1 to 3.9
ø25	M6 x 1	3.7 to 6.7
ø32, 40	M8 x 1.25	8.8 to 16.2
ø50, 63	M10 x 1.5	17.2 to 31.8

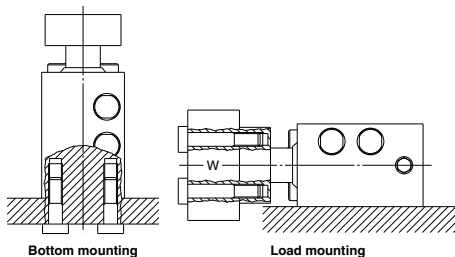

Plug Bolt Mounting (Optional)

Thread size	Tightening torque (N·m)
M5 x 0.8	2.1 to 3.9
M6 x 1	3.7 to 6.7
M8 x 1.25	8.8 to 16.2
M10 x 1.5	17.2 to 31.8

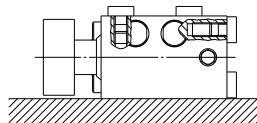

8. Install the load when the piston rod is retracted. [Series HYG]

The twist occurs in the guide part if the load is installed on the plate when the piston rod is extended, and it causes the malfunction.

### Lubrication

#### Caution

1. Lubrication of Hygienic Design Cylinder (standard grease use goods).

This unit can be operated without lubrication. If lubrication is performed, build in the lubricator in the circuit, use turbine oil Class 1 (with no additives) ISO VG-32.

Moreover, the malfunction will occur if the lubrication is discontinued on the way because the disappearance of the initial lubrication part. Lubricate without fail continuously. Consult with SMC if other lubricant are used.

CJ5  
CG5

HY

Water  
Resistant

D-

-X

Technical  
data



## Series HY □

# Specific Product Precautions 3

Be sure to read before handling. Refer to front matter 57 for Safety Instructions and pages 3 to 12 for Actuator and Auto Switch Precautions.

### Lubrication

#### ⚠ Caution

#### 2. Lubrication to Hygienic Design Cylinder (food compatible grease use goods).

If this unit is lubricated, it might cause the malfunction. Moreover, when a grease out of specification is used, it causes the malfunction.

- Place a purchase order with the following model number when only the grease for maintenance is necessary.
 

Standard grease (for non-food)	GR-S-010 (10 g)
Food compatible grease	GR-H-010 (10 g)

#### 3. Do not wipe off the grease adhering to the sliding part of the air cylinder.

It might cause the malfunction when compulsorily peeling off the adhering grease to the sliding parts. If the cylinder operates the long distance, the sliding parts might become black. In that case, the actuation becomes possible for a long term when the grease of the sliding parts is wiped off once, and it greases it again.

(Wipe off by water. If alcohol and a special solvent are used, the seal might be damaged.)

### Cushion (HYC)

#### ⚠ Caution

#### 1. Readjust with the cushion needle.

Readjust the cushion needle installed in the cover according to the load size and the operating speed before use, though it is adjusted to near the fully closed states when it ships. When the cushion adjuster is rotated to clockwise, the throttle strengthens becomes tight and the cushion strengthens will be good.

#### 2. Do not use the cushion needle for a long term in the fully closed states.

It causes the damage of the seal.

#### 3. Torque to the cushion adjuster should be below of the following torque when the cushion needle is adjusted.

Tightening torque (N-m)
0.5

Do not exceed the torque mentioned above. Otherwise it causes the damage.

#### 4. Do not exceed the adjustable range of cushion needle.

If cushion needle is rotated with the torque over adjustable range, it causes the damage.

Bore size	Rotations
ø32, 40	4 or less
ø50, 63	5 or less

### Piping

#### ⚠ Caution

#### 1. This product might be damaged if the compressed air is supplied to the breathing port for guide, so do not supply it. [Series HYG]

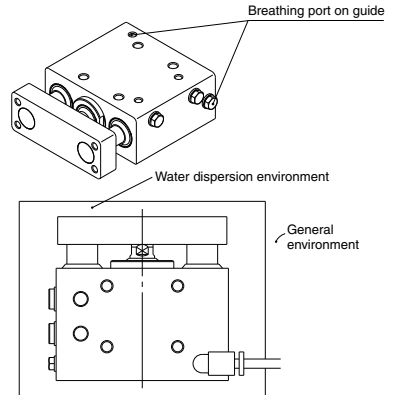

#### <Example>

- Piping is connected in the breathing port on guide, breathing at general environment is possible.

#### 2. Port plug piping ports and breathing port on guide according to the operating conditions. [Series HYG]

##### Piping Port

Bore size	Port plug thread size	Plug width across flats	Tightening torque (N-m)
ø20, 25	M5	8	After tightening by hand, tighten 1/6 turn.
ø32, 40	1/8	13	7 to 9
ø50, 63	1/4	16	12 to 14

##### Breathing Port for Guide

Bore size	Port plug thread size	Plug width across flats	Tightening torque (N-m)
ø20 to ø63	M5	8	After tightening by hand, tighten 1/6 turn.

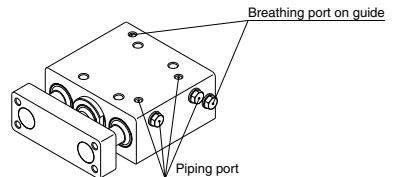

The figure above shows the status at shipment (top ported). The side ported can be constructed by changing the port plug position.

#### 3. Use the piping tube installed in the breathing port for guide is more than ø4 in bore size and within 3 m in length, otherwise the cylinder piston speed might decrease.



Series **HY**□

## Specific Product Precautions 4

Be sure to read before handling. Refer to front matter 57 for Safety Instructions and pages 3 to 12 for Actuator and Auto Switch Precautions.

### Caution on Handling

#### **Caution**

1. If the sliding parts is washed, the grease will wash out and the service life will be shorten, keep washing at a minimum.
2. Plug up unnecessary mounting holes with plug bolts or external cover (option), etc., bacteria might grow if water gets in these holes.

CJ5  
CG5

**HY**□

Water  
Resistant

D-□

-X□

Technical  
data