

60465-1 ✓ ACTIVE

FASTON | FASTON 250

TE Internal #: 60465-1

Tab, Mating Tab Width 6.35 mm [.25 in], PCB Hole Diameter 3.7 mm [.145 in], Through Hole - Screw, Unplated Plating, Brass, FASTON 250, PCB Terminals

[View on TE.com >](#)



Terminals & Splices > PCB Terminals

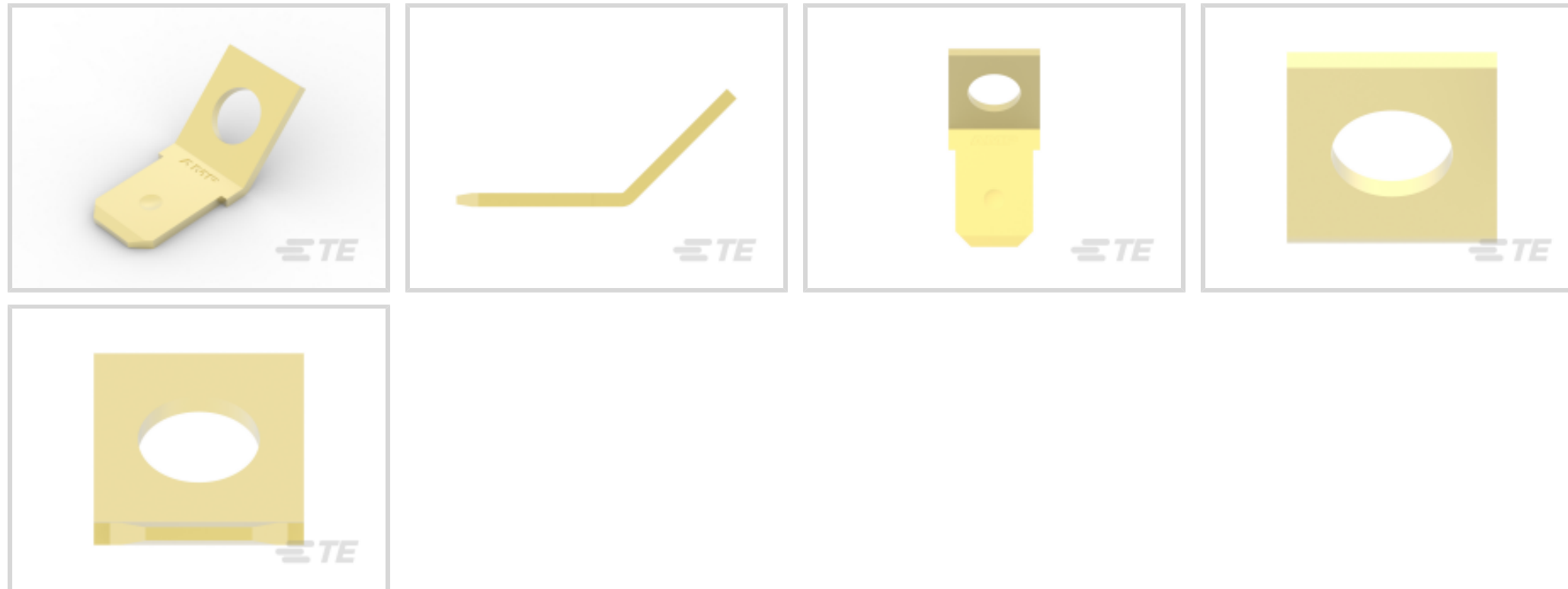

PCB Terminal Type: **Tab**

Mating Tab Width: **6.35 mm [.25 in]**

Mating Tab Thickness: **.83 mm [.033 in]**

PCB Hole Diameter: **3.7 mm [.145 in]**

Termination Method to PCB: **Through Hole - Screw**

## Features

### Product Type Features

Terminal Features	Stud Hole
-------------------	-----------

### Contact Features

PCB Terminal Type	Tab
Mating Tab Width	6.35 mm [.25 in]
Mating Tab Thickness	.83 mm [.033 in]
Terminal Plating Material	Unplated
Contact Underplating Material	Brass
Terminal Size	6.35
Terminal Orientation	45 Bend

### Termination Features

Termination Method to PCB	Through Hole - Screw
Product Terminates To	Printed Circuit Board

### Dimensions

Terminal Material Thickness	.81 mm [.032 in]
-----------------------------	------------------



Stud Diameter	4.34 mm[.171 in]
---------------	------------------

PCB Hole Diameter	3.7 mm[.145 in]
-------------------	-----------------

### Usage Conditions

Insulation Option	Uninsulated
-------------------	-------------

Operating Temperature Range	-30 – 110 °C[-22 – 230 °F]
-----------------------------	----------------------------

### Packaging Features

Packaging Quantity	1000
--------------------	------

Packaging Method	Bag
------------------	-----

### Product Compliance

For compliance documentation, visit the product page on [TE.com](https://www.te.com)>

EU RoHS Directive 2011/65/EU	Compliant
------------------------------	-----------

EU ELV Directive 2000/53/EC	Compliant
-----------------------------	-----------

China RoHS 2 Directive MIIT Order No 32, 2016	No Restricted Materials Above Threshold
---	---

EU REACH Regulation (EC) No. 1907/2006	Current ECHA Candidate List: JUNE 2024 (241) Candidate List Declared Against: JUNE 2024 (241) Does not contain REACH SVHC
--	---

Halogen Content	Low Halogen - Br, Cl, F, I < 900 ppm per homogenous material. Also BFR/CFR/PVC Free
-----------------	---

Solder Process Capability	Not applicable for solder process capability
---------------------------	--

#### Product Compliance Disclaimer

This information is provided based on reasonable inquiry of our suppliers and represents our current actual knowledge based on the information they provided. This information is subject to change. The part numbers that TE has identified as EU RoHS compliant have a maximum concentration of 0.1% by weight in homogenous materials for lead, hexavalent chromium, mercury, PBB, PBDE, DBP, BBP, DEHP, DIBP, and 0.01% for cadmium, or qualify for an exemption to these limits as defined in the Annexes of Directive 2011/65/EU (RoHS2). Finished electrical and electronic equipment products will be CE marked as required by Directive 2011/65/EU. Components may not be CE marked. Additionally, the part numbers that TE has identified as EU ELV compliant have a maximum concentration of 0.1% by weight in homogenous materials for lead, hexavalent chromium, and mercury, and 0.01% for cadmium, or qualify for an exemption to these limits as defined in the Annexes of Directive 2000/53/EC (ELV). Regarding the REACH Regulation, the information TE provides on SVHC in articles for this part number is based on the latest European Chemicals Agency (ECHA) 'Guidance on requirements for substances in articles' posted at this URL: <https://echa.europa.eu/guidance-documents/guidance-on-reach>

### Compatible Parts



Also in the Series | **FASTON 250**

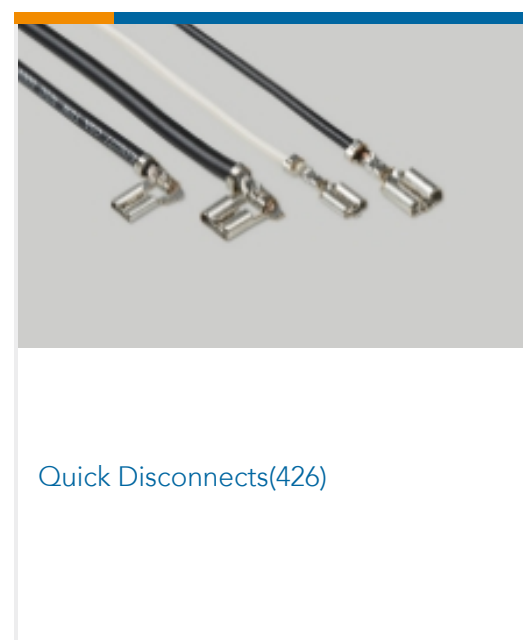
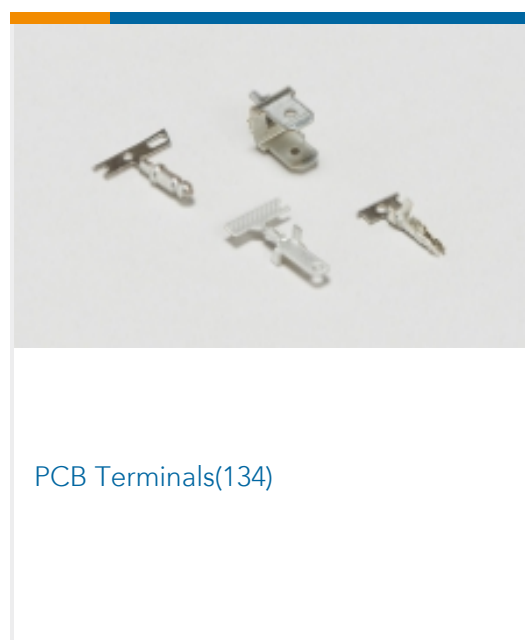
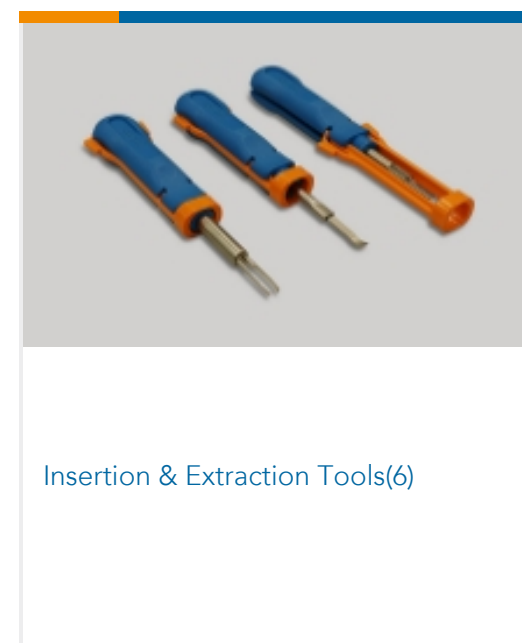
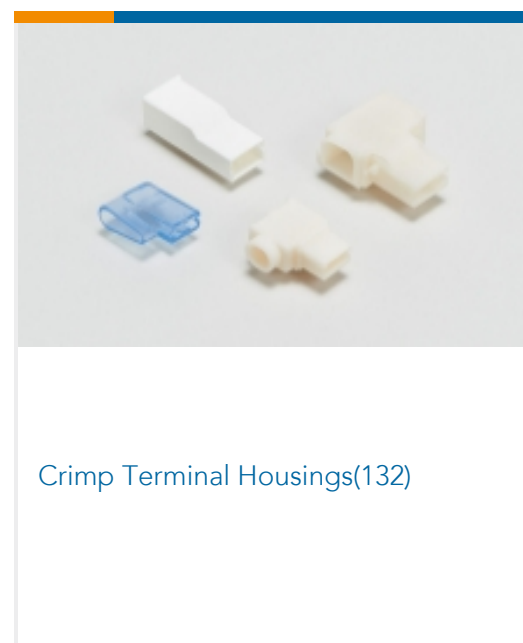
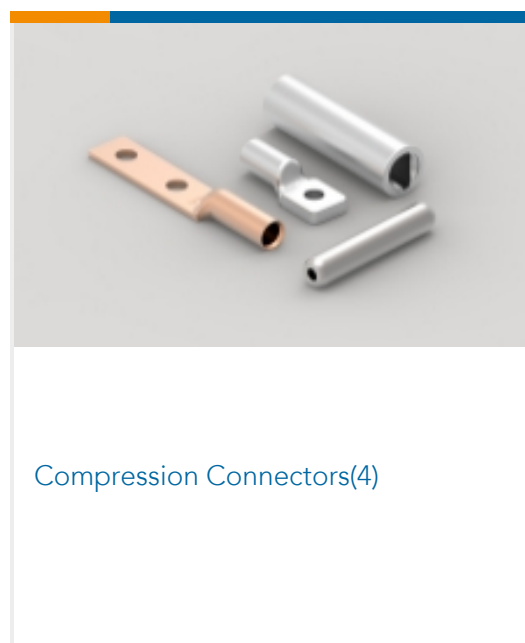

Customers Also Bought



TE Part #8-35112-1  
TERMINAL,PIDG R 12-10 3/8

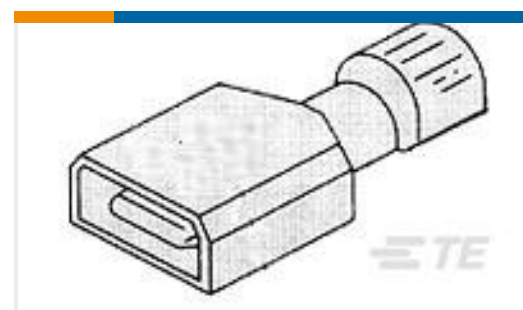

TE Part #2-521105-2  
ULTRA-FAST 187 ASY REC 22-18 TPBR



TE Part #3-520370-2  
ULTRA-FAST 110/125 ASY REC 16-14AWG TPBR



TE Part #41330  
RING 18-14 AWG TPBR



TE Part #42617-1  
187 FASTON REC 20-16 AWG BR



TE Part #1445715-5  
75A HSG SUBASY RED



TE Part #42741-1  
250 FASTON,REC.,18-14,BR



TE Part #1379218-2  
COVER FOR 5W MPO+MOS HSG

## Documents

### Product Drawings

#### 250 FASTON TAB BR

English

### CAD Files

#### Customer View Model

[ENG\\_CVM\\_CVM\\_60465-1\\_K.2d\\_dxf.zip](#)

English

#### 3D PDF

3D

#### Customer View Model

[ENG\\_CVM\\_CVM\\_60465-1\\_K.3d\\_igs.zip](#)

English

#### Customer View Model

[ENG\\_CVM\\_CVM\\_60465-1\\_K.3d\\_stp.zip](#)

English

By downloading the CAD file I accept and agree to the [Terms and Conditions](#) of use.

### Datasheets & Catalog Pages

#### FASTON Tabs

English

### Product Specifications

#### Application Specification

English

### Agency Approvals

#### CSA Certificate

60465-1

Tab, Mating Tab Width 6.35 mm [.25 in], PCB Hole Diameter 3.7 mm [.145 in],  
Through Hole - Screw, Unplated Plating, Brass, FASTON 250, PCB Terminals



English

[CSA Certificate](#)

English