

**Description**

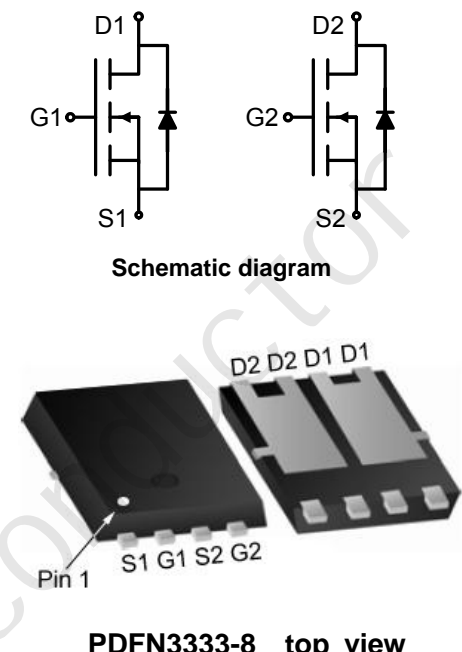
The JSM3622 uses advanced trench technology to provide excellent  $R_{DS(ON)}$ , low gate charge and operation with gate voltages as low as 2.5V. This device is suitable for use as a Battery protection or in other switching application.

**General Feature**

- $V_{DS} = 30V, I_D = 25A$
- $R_{DS(ON) \text{ typ}} = 12m\Omega @ V_{GS} = 10V$
- $R_{DS(ON) \text{ typ}} = 16m\Omega @ V_{GS} = 4.5V$
- High Power and current handing capability
- Lead free product is acquired
- Surface mount package

**Application**

- Battery switch
- DC/DC converter



**Schematic diagram**

**PDFN3333-8 top view**

### Absolute Maximum Ratings ( $T_A = 25^\circ C$ unless otherwise noted)

Parameter	Symbol	Limit	Unit
Drain-Source Voltage	$V_{DS}$	30	V
Gate-Source Voltage	$V_{GS}$	$\pm 20$	V
Drain Current-Continuous	$I_D$	25	A
Drain Current-Pulsed <sup>(Note 1)</sup>	$I_{DM}$	75	A
Maximum Power Dissipation	$P_D$	3.5	W
Operating Junction and Storage Temperature Range	$T_J, T_{STG}$	-55 To 150	$^\circ C$

### Thermal Characteristic

Thermal Resistance, Junction-to-Ambient <sup>(Note 2)</sup>	$R_{\theta JA}$	35	$^\circ C/W$
---	-----------------	----	--------------

### Electrical Characteristics ( $T_A = 25^\circ C$ unless otherwise noted)

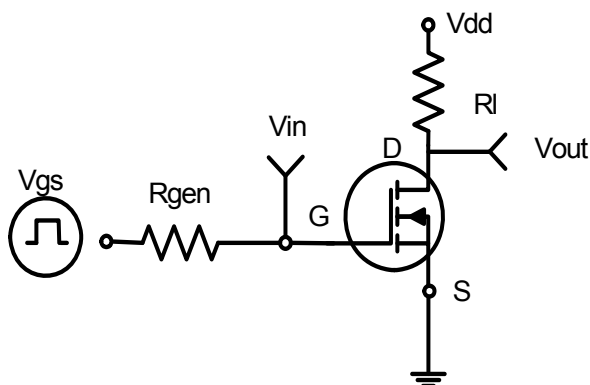
Parameter	Symbol	Condition	Min	Typ	Max	Unit
<b>Off Characteristics</b>						
Drain-Source Breakdown Voltage	$BV_{DSS}$	$V_{GS} = 0V, I_D = 250\mu A$	30	-	-	V
Zero Gate Voltage Drain Current	$I_{DSS}$	$V_{DS} = 30V, V_{GS} = 0V$	-	-	1	$\mu A$

Parameter	Symbol	Condition	Min	Typ	Max	Unit
Gate-Body Leakage Current	$I_{GSS}$	$V_{GS}=\pm 20V, V_{DS}=0V$	-	-	$\pm 100$	nA
<b>On Characteristics</b> (Note 3)						
Gate Threshold Voltage	$V_{GS(th)}$	$V_{DS}=V_{GS}, I_D=250\mu A$	1.0	1.6	2.4	V
Drain-Source On-State Resistance	$R_{DS(ON)}$	$V_{GS}=10V, I_D=15A$		12	14	m $\Omega$
		$V_{GS}=4.5V, I_D=10A$		16	18	m $\Omega$
<b>Dynamic Characteristics</b> (Note 4)						
Input Capacitance	$C_{iss}$	$V_{DS}=15V, V_{GS}=0V,$ $F=1.0MHz$	-	564	-	PF
Output Capacitance	$C_{oss}$		-	75	-	PF
Reverse Transfer Capacitance	$C_{rss}$		-	66	-	PF
<b>Switching Characteristics</b> (Note 4)						
Turn-on Delay Time	$t_{d(on)}$	$V_{DD}=30V, I_D=1.5A$ $V_{GS}=10V, R_{GEN}=1\Omega$	-	9	-	nS
Turn-on Rise Time	$t_r$		-	10	-	nS
Turn-Off Delay Time	$t_{d(off)}$		-	15	-	nS
Turn-Off Fall Time	$t_f$		-	5	-	nS
Total Gate Charge	$Q_g$	$V_{DS}=30V, I_D=15A,$ $V_{GS}=10V$	-	14.2	-	nC
Gate-Source Charge	$Q_{gs}$		-	1.5	-	nC
Gate-Drain Charge	$Q_{gd}$		-	3.6	-	nC
<b>Drain-Source Diode Characteristics</b>						
Diode Forward Voltage (Note 3)	$V_{SD}$	$V_{GS}=0V, I_S=15A$			1.2	V
Diode Forward Current (Note 2)	$I_S$				25	A

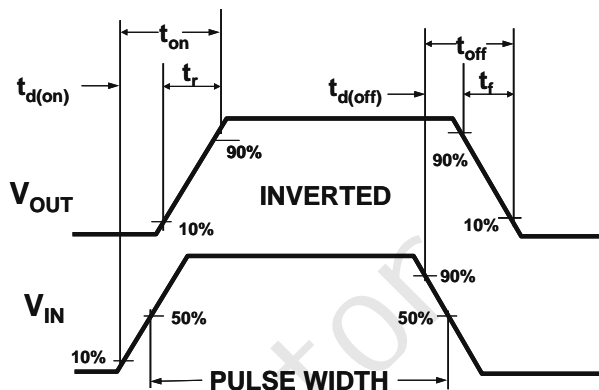
**Notes:**

1. Repetitive Rating: Pulse width limited by maximum junction temperature.
2. Surface Mounted on FR4 Board,  $t \leq 10$  sec.
3. Pulse Test: Pulse Width  $\leq 300\mu s$ , Duty Cycle  $\leq 2\%$ .
4. Guaranteed by design, not subject to production

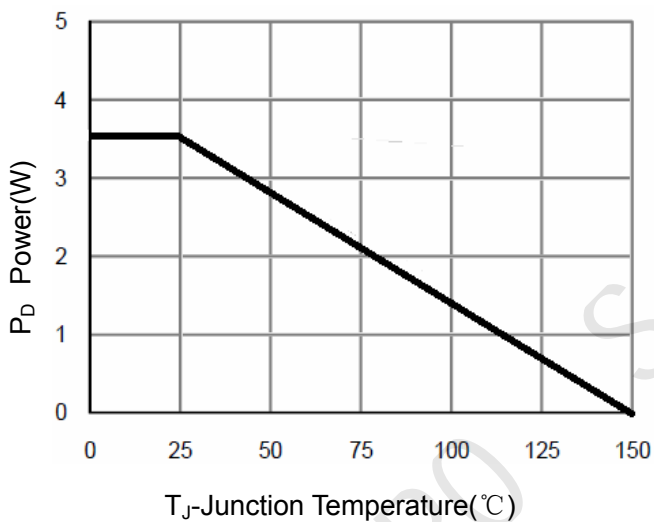
**Typical Electrical and Thermal Characteristics**



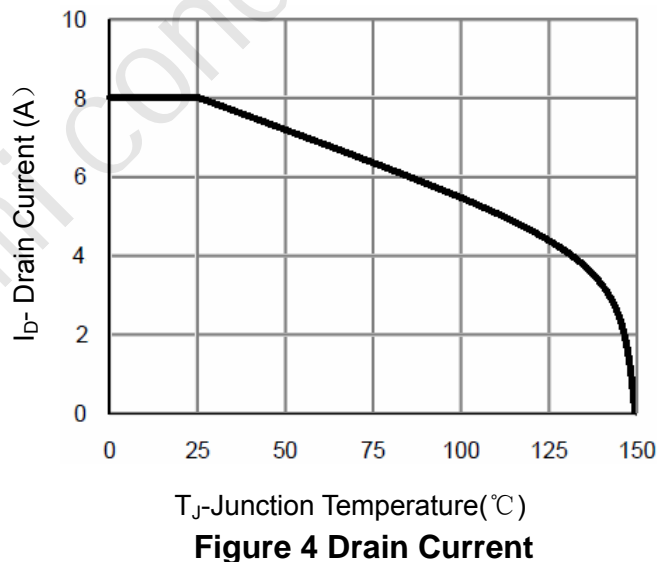
**Figure 1 Switching Test Circuit**



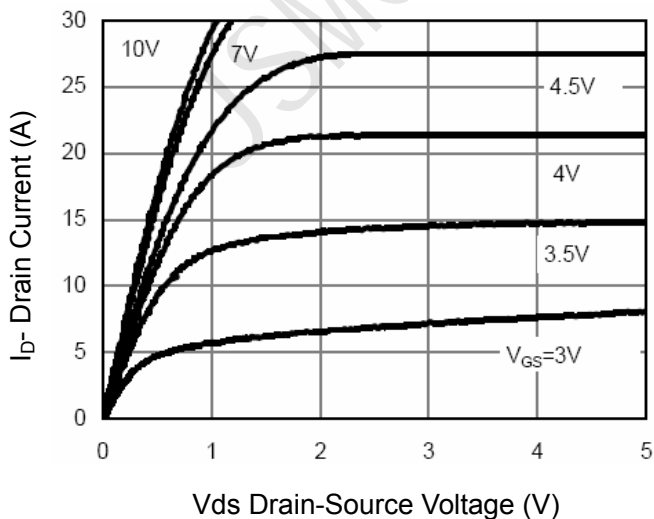
**Figure 2 Switching Waveforms**



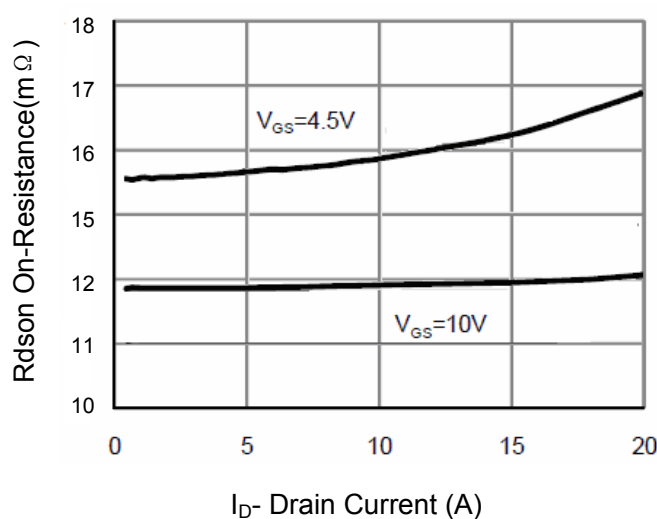
**Figure 3 Power Dissipation**



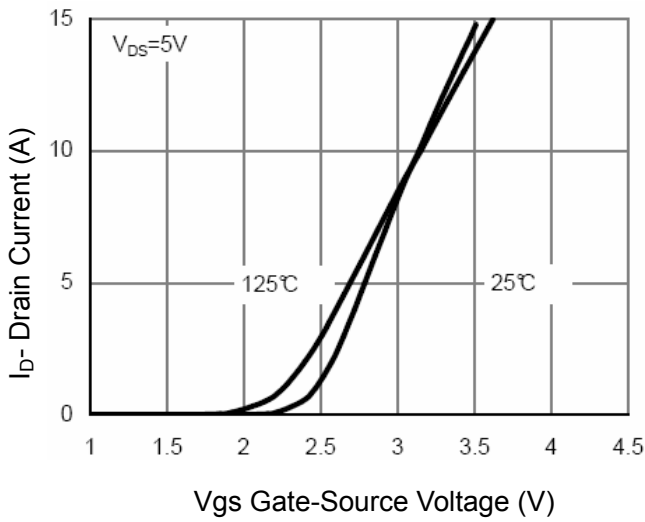
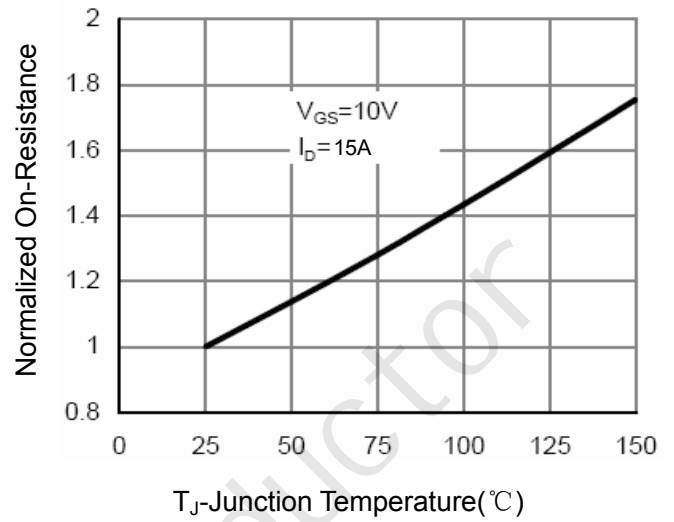
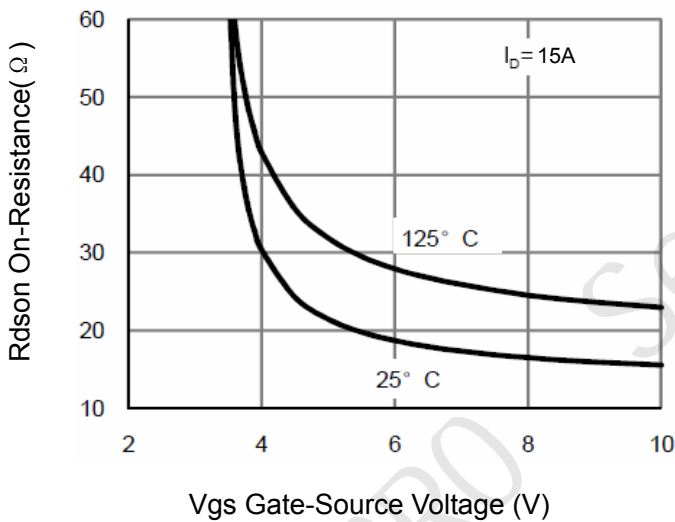
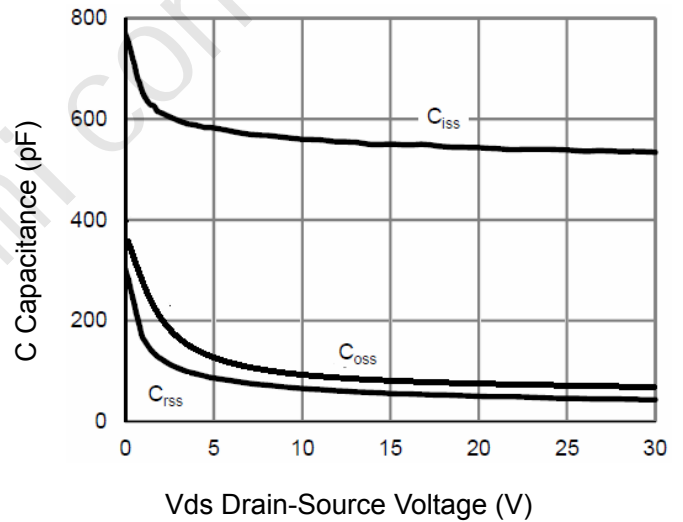
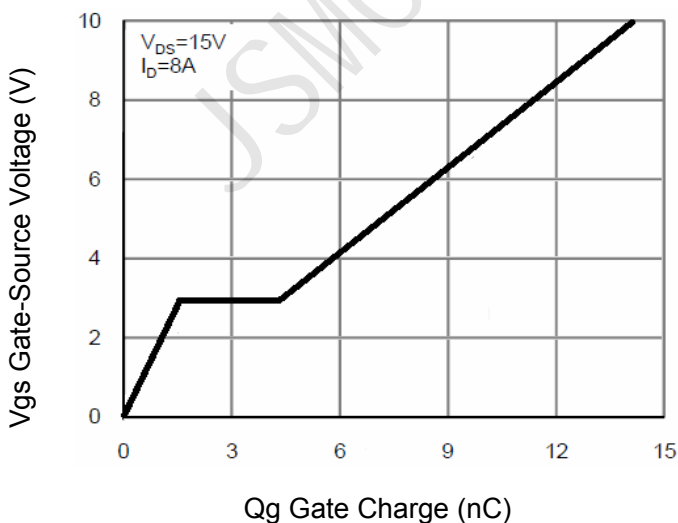
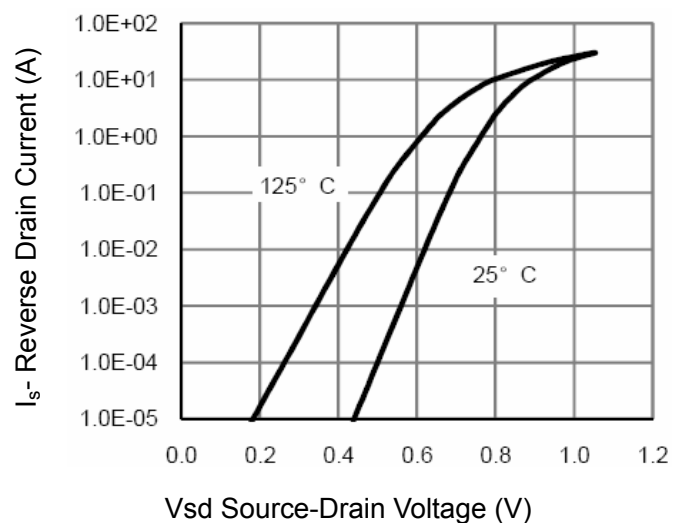
**Figure 4 Drain Current**

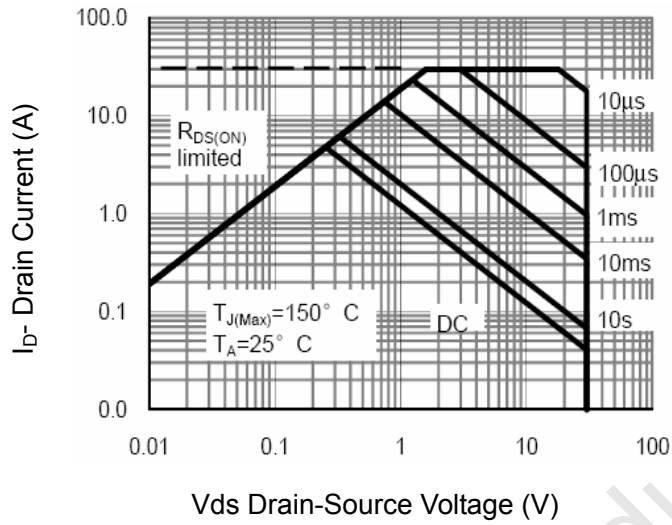


**Figure 5 Output Characteristics**

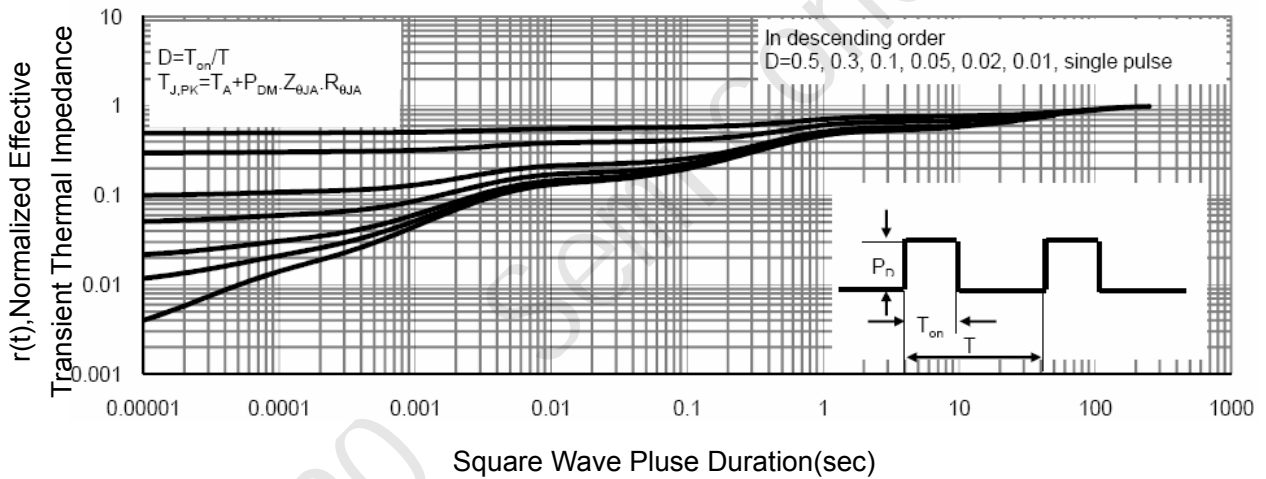


**Figure 6 Drain-Source On-Resistance**

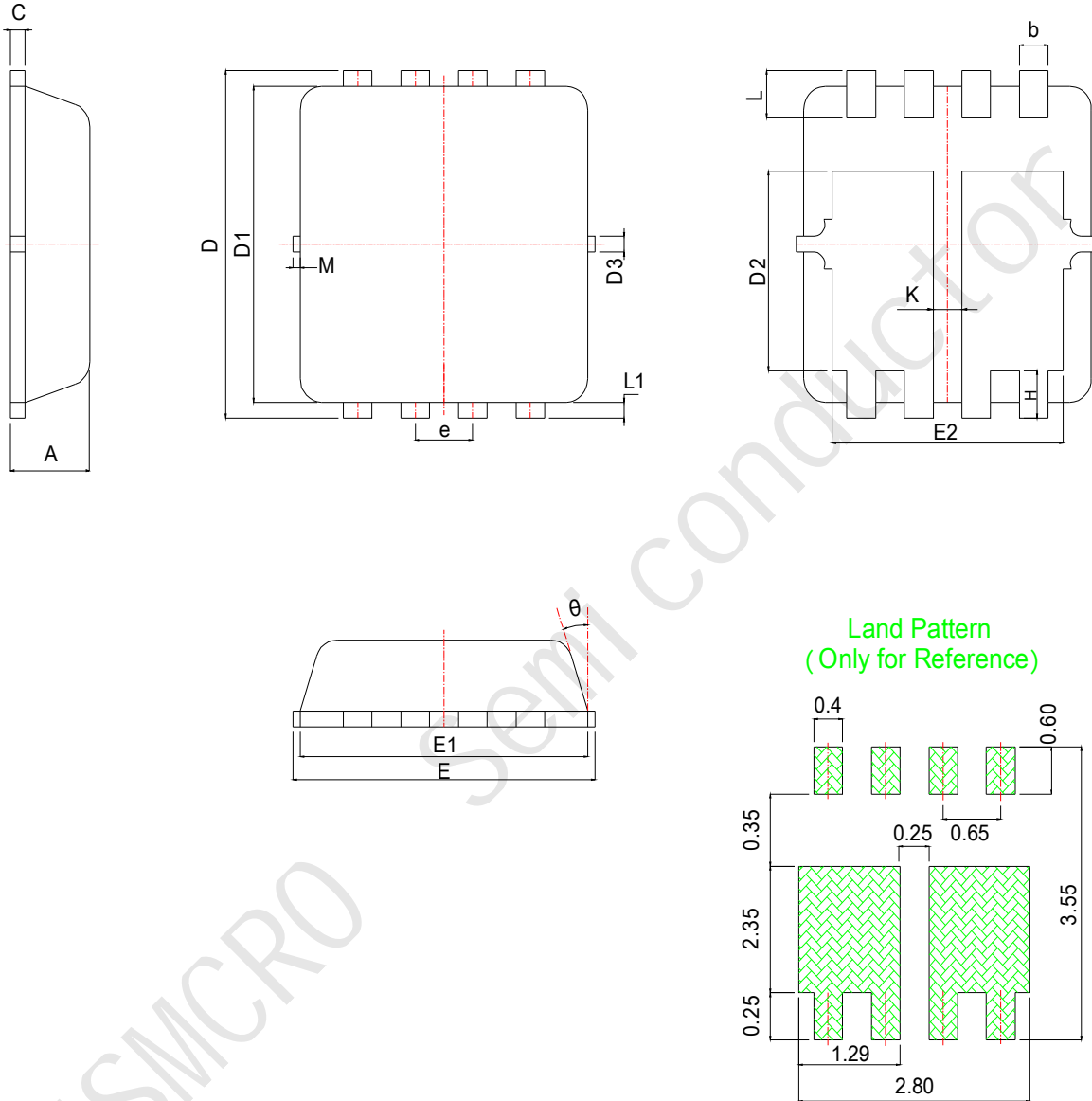

**Figure 7 Transfer Characteristics**

**Figure 8 Drain-Source On-Resistance**

**Figure 9 Rdson vs Vgs**

**Figure 10 Capacitance vs Vds**

**Figure 11 Gate Charge**

**Figure 12 Source- Drain Diode Forward**



**Figure 13 Safe Operation Area**



**Figure 14 Normalized Maximum Transient Thermal Impedance**

**PDFN3333**


SYMBOL	MM			INCH			SYMBOL	MM			INCH		
	MIN	NOM	MAX	MIN	NOM	MAX		MIN	NOM	MAX	MIN	NOM	MAX
A	0.70	0.75	0.80	0.028	0.030	0.031	E1	3.00	3.15	3.20	0.118	0.122	0.126
b	0.25	0.30	0.35	0.010	0.012	0.014	E2	2.39	2.49	2.59	0.094	0.098	0.102
c	0.10	0.15	0.25	0.004	0.007	0.010	e	0.65BSC			0.026BSC		
D	3.25	3.35	3.45	0.128	0.132	0.136	H	0.30	0.40	0.50	0.012	0.016	0.020
D1	3.00	3.10	3.20	0.118	0.122	0.126	L	0.30	0.40	0.50	0.012	0.016	0.020
D2	1.78	1.88	1.98	0.070	0.074	0.078	L1	*	0.13	*	*	0.005	*
D3	*	0.13	*	*	0.005	*	theta	*	10°	12°	*	10°	12°
E	3.20	3.30	3.40	0.126	0.130	0.134	M	*	*	0.15	*	*	0.006
K	0.30	*	*	0.012	*	*							