

# TLV2217 LOW-DROPOUT FIXED-VOLTAGE REGULATORS

SLVS067L – MARCH 1992 – REVISED APRIL 2005

- Fixed 1.8-V, 2.5-V, and 3.3-V Outputs
- $\pm 1\%$  Maximum Output Voltage Tolerance at  $T_J = 25^\circ\text{C}$
- 500-mV Maximum Dropout Voltage at 500 mA (3.3-V Option)
- $\pm 2\%$  Output Voltage Variation Across Load and Temperature
- Internal Overcurrent Limiting
- Internal Thermal-Overload Protection
- Internal Overvoltage Protection

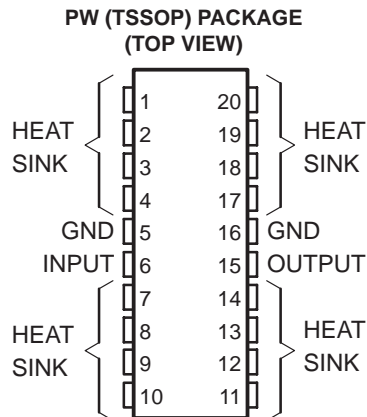

HEAT SINK – These terminals have an internal resistive connection to ground and should be grounded or electrically isolated.

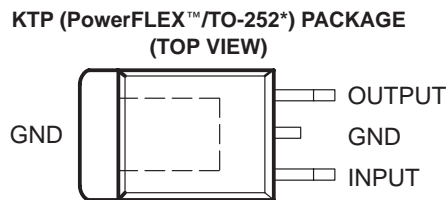

\*Complies with JEDEC TO-252, variation AC

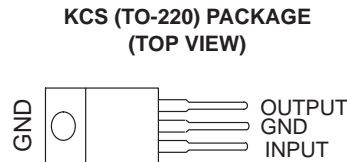
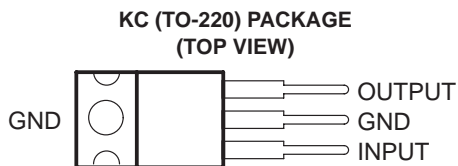

## description/ordering information

### ORDERING INFORMATION

$T_J$	$V_O$ (NOM)	PACKAGE†		ORDERABLE PART NUMBER	TOP-SIDE MARKING
0°C to 125°C	1.8 V	PowerFLEX™/TO-252* (KTP)	Reel of 3000	TLV2217-18KTPR	2217-18
		TO-220 (KCS)	Tube of 50	TLV2217-18KCS	TLV2217-18
	2.5 V	TO-220 (KC)	Tube of 50	TLV2217-25KC	TLV2217-25
		PowerFLEX™/TO-252* (KTP)	Reel of 3000	TLV2217-25KTPR	2217-25
		TSSOP (PW)	Tube of 70 Reel of 2000	TLV2217-25PW TLV2217-25PWR	2217-25
	3.3 V	PowerFLEX™/TO-252* (KTP)	Reel of 3000	TLV2217-33KTPR	2217-33
		TO-220 (KC)	Tube of 50	TLV2217-33KC	TLV2217-33
		TSSOP (PW)	Reel of 2000	TLV2217-33PWR	2217-33

\*Complies to TO-252, variation AC.

† Package drawings, standard packing quantities, thermal data, symbolization, and PCB design guidelines are available at [www.ti.com/sc/package](http://www.ti.com/sc/package).



Please be aware that an important notice concerning availability, standard warranty, and use in critical applications of Texas Instruments semiconductor products and disclaimers thereto appears at the end of this data sheet.

PowerFLEX is a trademark of Texas Instruments.

PRODUCTION DATA information is current as of publication date. Products conform to specifications per the terms of Texas Instruments standard warranty. Production processing does not necessarily include testing of all parameters.



POST OFFICE BOX 655303 • DALLAS, TEXAS 75265

Copyright © 2005, Texas Instruments Incorporated

# TLV2217 LOW-DROPOUT FIXED-VOLTAGE REGULATORS

SLVS067L – MARCH 1992 – REVISED APRIL 2005

## description/ordering information (continued)

The TLV2217 family of low-dropout regulators offers a variety of fixed-voltage options that offer a maximum continuous input voltage of 16 V, making them more versatile than CMOS regulators. Utilizing a pnp pass element, these regulators are capable of sourcing 500 mA of current, with a specified maximum dropout of 500 mV (3.3-V and 2.5-V options), making these regulators ideal for low-voltage applications. Additionally, the TLV2217 regulators offer very tight output accuracy of  $\pm 2\%$  across operating load and temperature ranges. Other convenient features the regulators provide are internal overcurrent limiting, thermal-overload protection, and overvoltage protection. The TLV2217 family of regulators is available in fixed voltages of 1.8 V, 2.5 V, and 3.3 V.

## absolute maximum ratings over operating virtual junction temperature range (unless otherwise noted)<sup>†</sup>

Continuous input voltage,  $V_I$  ..... 16 V  
 Operating virtual junction temperature,  $T_J$  ..... 150°C  
 Storage temperature range,  $T_{stg}$  ..... -65°C to 150°C

<sup>†</sup> Stresses beyond those listed under “absolute maximum ratings” may cause permanent damage to the device. These are stress ratings only, and functional operation of the device at these or any other conditions beyond those indicated under “recommended operating conditions” is not implied. Exposure to absolute-maximum-rated conditions for extended periods may affect device reliability.

## package thermal data (see Note 1)

PACKAGE	BOARD	$\theta_{JP}$ <sup>‡</sup>	$\theta_{JC}$	$\theta_{JA}$
PowerFLEX™/TO-252 (KTP)	High K, JESD 51-5	1.4°C/W	19°C/W	28°C/W
TO-220 (KC/KCS)	High K, JESD 51-5	3°C/W	17°C/W	19°C/W
TSSOP (PW)	High K, JESD 51-7		32°C/W	83°C/W

<sup>‡</sup> For packages with exposed thermal pads, such as QFN, PowerPAD, and PowerFLEX,  $\theta_{JP}$  is defined as the thermal resistance between the die junction and the bottom of the exposed pad.

NOTE 1: Maximum power dissipation is a function of  $T_J(\max)$ ,  $\theta_{JA}$ , and  $T_A$ . The maximum allowable power dissipation at any allowable ambient temperature is  $P_D = (T_J(\max) - T_A)/\theta_{JA}$ . Operating at the absolute maximum  $T_J$  of 150°C can affect reliability.

## recommended operating conditions

	MIN	MAX	UNIT
$V_I$ Input voltage	3.0	12	V
$I_O$ Output current	0	500	mA
$T_J$ Operating virtual junction temperature range	0	125	°C

<sup>§</sup> Minimum  $V_I$  is equal to 3.0 V or  $V_O(\max) + 0.6$  V, whichever is greater.



# TLV2217 LOW-DROPOUT FIXED-VOLTAGE REGULATORS

SLVS067L – MARCH 1992 – REVISED APRIL 2005

## electrical characteristics at $V_I = 4.5\text{ V}$ , $I_O = 500\text{ mA}$ , $T_J = 25^\circ\text{C}$ (unless otherwise noted)

PARAMETER	TEST CONDITION <sup>†</sup>	TLV2217-33			UNIT	
		MIN	TYP	MAX		
Output voltage	$I_O = 20\text{ mA to }500\text{ mA}$ , $V_I = 3.8\text{ V to }5.5\text{ V}$	$T_J = 25^\circ\text{C}$	3.267	3.30	3.333	V
		$T_J = 0^\circ\text{C to }125^\circ\text{C}$	3.234		3.366	
Input voltage regulation	$V_I = 3.8\text{ V to }5.5\text{ V}$		5	15	mV	
Ripple rejection	$f = 120\text{ Hz}$ , $V_{\text{ripple}} = 1\text{ V}_{\text{PP}}$ , $V_I = 4.5\text{ V}$		-62		dB	
Output voltage regulation	$I_O = 20\text{ mA to }500\text{ mA}$		5	30	mV	
Output noise voltage	$f = 10\text{ Hz to }100\text{ kHz}$		500		$\mu\text{V}$	
Dropout voltage	$I_O = 250\text{ mA}$			400	mV	
	$I_O = 500\text{ mA}$			500		
Bias current	$I_O = 0$		2	5	mA	
	$I_O = 500\text{ mA}$		19	49		

<sup>†</sup> Pulse-testing techniques are used to maintain the virtual junction temperature as close to the ambient temperature as possible. Thermal effects must be taken into account separately. All characteristics are measured with a 0.1- $\mu\text{F}$  capacitor across the input and a 22- $\mu\text{F}$  tantalum capacitor, with equivalent series resistance of 1.5  $\Omega$ , on the output.

## electrical characteristics at $V_I = 3.3\text{ V}$ , $I_O = 500\text{ mA}$ , $T_J = 25^\circ\text{C}$ (unless otherwise noted)

PARAMETER	TEST CONDITION <sup>†</sup>	TLV2217-25			UNIT	
		MIN	TYP	MAX		
Output voltage	$I_O = 20\text{ mA to }500\text{ mA}$ , $V_I = 3.0\text{ V to }5.5\text{ V}$	$T_J = 25^\circ\text{C}$	2.475	2.5	2.525	V
		$T_J = 0^\circ\text{C to }125^\circ\text{C}$	2.45		2.55	
Input voltage regulation	$V_I = 3.0\text{ V to }5.5\text{ V}$		4	12	mV	
Ripple rejection	$f = 120\text{ Hz}$ , $V_{\text{ripple}} = 1\text{ V}_{\text{PP}}$ , $V_I = 4.5\text{ V}$		-62		dB	
Output voltage regulation	$I_O = 20\text{ mA to }500\text{ mA}$		4	23	mV	
Output noise voltage	$f = 10\text{ Hz to }100\text{ kHz}$		500		$\mu\text{V}$	
Dropout voltage	$I_O = 250\text{ mA}$			400	mV	
	$I_O = 500\text{ mA}$			500		
Bias current	$I_O = 0$		2	5	mA	
	$I_O = 500\text{ mA}$		19	49		

<sup>†</sup> Pulse-testing techniques are used to maintain the virtual junction temperature as close to the ambient temperature as possible. Thermal effects must be taken into account separately. All characteristics are measured with a 0.1- $\mu\text{F}$  capacitor across the input and a 22- $\mu\text{F}$  tantalum capacitor, with equivalent series resistance of 1.5  $\Omega$ , on the output.

# TLV2217

## LOW-DROPOUT FIXED-VOLTAGE REGULATORS

SLVS067L – MARCH 1992 – REVISED APRIL 2005

### electrical characteristics at $V_I = 3.3\text{ V}$ , $I_O = 500\text{ mA}$ , $T_J = 25^\circ\text{C}$ (unless otherwise noted)

PARAMETER	TEST CONDITIONS†	TLV2217-18			UNIT	
		MIN	TYP	MAX		
Output voltage	$I_O = 20\text{ mA to }500\text{ mA}$ , $V_I = 3.0\text{ V to }5.5\text{ V}$	$T_J = 25^\circ\text{C}$	1.782	1.8	1.818	V
		$T_J = 0^\circ\text{C to }125^\circ\text{C}$	1.764		1.836	
Input voltage regulation	$V_I = 3.0\text{ V to }5.5\text{ V}$		3	9	mV	
Ripple rejection	$f = 120\text{ Hz}$ , $V_{\text{ripple}} = 1\text{ V}_{\text{PP}}$ , $V_I = 4.5\text{ V}$		-62		dB	
Output voltage regulation	$I_O = 20\text{ mA to }500\text{ mA}$		3	17	mV	
Output noise voltage	$f = 10\text{ Hz to }100\text{ kHz}$		500		$\mu\text{V}$	
Dropout voltage	$I_O = 250\text{ mA}$		‡		mV	
	$I_O = 500\text{ mA}$		‡			
Bias current	$I_O = 0$		2	5	mA	
	$I_O = 500\text{ mA}$		19	49		

† Pulse-testing techniques are used to maintain the virtual junction temperature as close to the ambient temperature as possible. Thermal effects must be taken into account separately. All characteristics are measured with a 0.1- $\mu\text{F}$  capacitor across the input and a 22- $\mu\text{F}$  tantalum capacitor, with equivalent series resistance of 1.5  $\Omega$ , on the output.

‡ Dropout voltage is limited by the input voltage range, with minimum  $V_I = 3.0\text{ V}$ .

## COMPENSATION-CAPACITOR SELECTION INFORMATION

The TLV2217 is a low-dropout regulator. This means that the capacitance loading is important to the performance of the regulator because it is a vital part of the control loop. The capacitor value and the equivalent series resistance (ESR) both affect the control loop and must be defined for the load range and the temperature range. Figures 1 and 2 can be used to establish the capacitance value and ESR range for the best regulator performance.

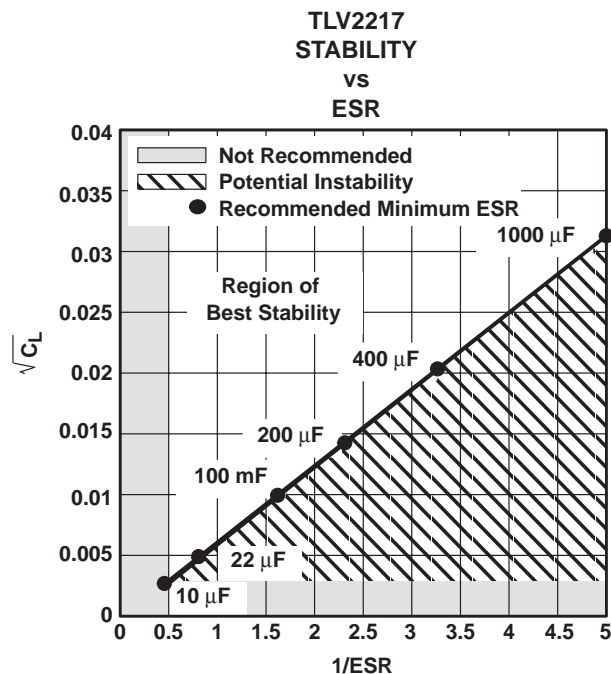
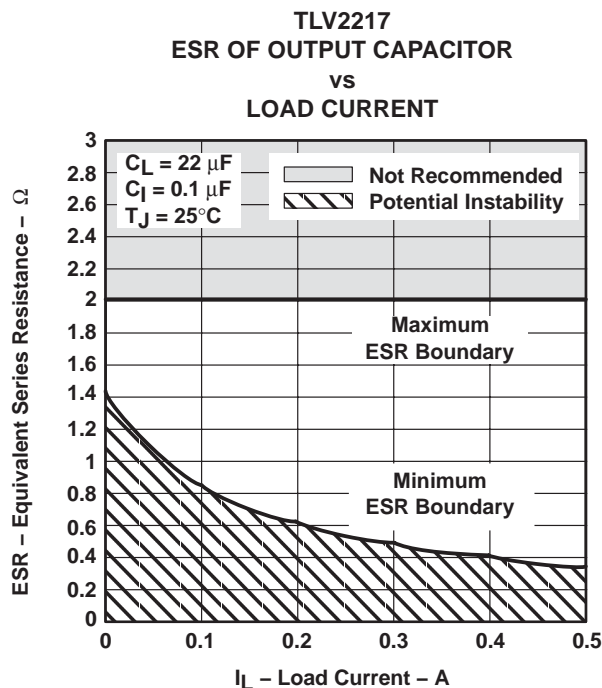

Figure 2

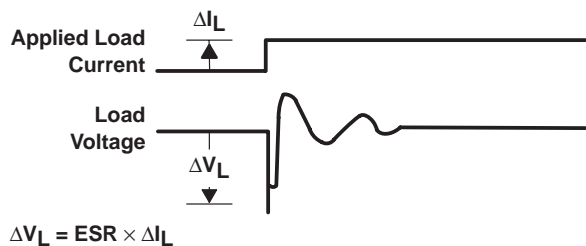

Figure 1

typical application schematic

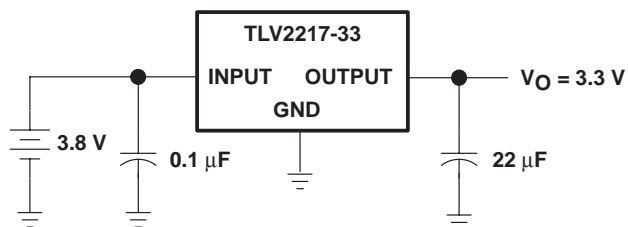

Figure 3

**PACKAGING INFORMATION**

Orderable Device	Status <sup>(1)</sup>	Package Type	Package Drawing	Pins	Package Qty	Eco Plan <sup>(2)</sup>	Lead/Ball Finish	MSL Peak Temp <sup>(3)</sup>	Samples (Requires Login)
TLV2217-18KCS	ACTIVE	TO-220	KCS	3	50	Pb-Free (RoHS)	CU SN	N / A for Pkg Type	<a href="#">Request Free Samples</a>
TLV2217-18KCE3	ACTIVE	TO-220	KCS	3	50	Pb-Free (RoHS)	CU SN	N / A for Pkg Type	<a href="#">Request Free Samples</a>
TLV2217-18KTPR	OBSOLETE	PFM	KTP	2		TBD	Call TI	Call TI	Samples Not Available
TLV2217-18KTPRG3	OBSOLETE	PFM	KTP	2		TBD	Call TI	Call TI	Samples Not Available
TLV2217-18KVURG3	ACTIVE	PFM	KVU	3	2500	Green (RoHS & no Sb/Br)	CU SN	Level-3-260C-168 HR	<a href="#">Request Free Samples</a>
TLV2217-25KC	OBSOLETE	TO-220	KC	3		TBD	Call TI	Call TI	Samples Not Available
TLV2217-25KCE3	OBSOLETE	TO-220	KC	3		TBD	Call TI	Call TI	Samples Not Available
TLV2217-25KCE3	ACTIVE	TO-220	KCS	3	50	Pb-Free (RoHS)	CU SN	N / A for Pkg Type	<a href="#">Request Free Samples</a>
TLV2217-25KTPR	OBSOLETE	PFM	KTP	2		TBD	Call TI	Call TI	Samples Not Available
TLV2217-25KTPRG3	OBSOLETE	PFM	KTP	2		TBD	Call TI	Call TI	Samples Not Available
TLV2217-25KVURG3	ACTIVE	PFM	KVU	3	1	Green (RoHS & no Sb/Br)	CU SN	Level-3-260C-168 HR	<a href="#">Request Free Samples</a>
TLV2217-25PW	ACTIVE	TSSOP	PW	20		TBD	Call TI	Call TI	<a href="#">Purchase Samples</a>
TLV2217-25PWE4	ACTIVE	TSSOP	PW	20		TBD	Call TI	Call TI	<a href="#">Purchase Samples</a>
TLV2217-25PWG4	ACTIVE	TSSOP	PW	20		TBD	Call TI	Call TI	<a href="#">Purchase Samples</a>
TLV2217-25PWR	ACTIVE	TSSOP	PW	20	2000	Green (RoHS & no Sb/Br)	CU NIPD	Level-1-260C-UNLIM	Contact TI Distributor or Sales Office
TLV2217-25PWRE4	ACTIVE	TSSOP	PW	20	2000	Green (RoHS & no Sb/Br)	CU NIPD	Level-1-260C-UNLIM	Contact TI Distributor or Sales Office
TLV2217-25PWRG4	ACTIVE	TSSOP	PW	20	2000	Green (RoHS & no Sb/Br)	CU NIPD	Level-1-260C-UNLIM	Contact TI Distributor or Sales Office
TLV2217-33KC	OBSOLETE	TO-220	KC	3		TBD	Call TI	Call TI	Samples Not Available
TLV2217-33KCE3	OBSOLETE	TO-220	KC	3		TBD	Call TI	Call TI	Samples Not Available
TLV2217-33KCE3	ACTIVE	TO-220	KCS	3	50	Pb-Free (RoHS)	CU SN	N / A for Pkg Type	<a href="#">Request Free Samples</a>
TLV2217-33KTPR	OBSOLETE	PFM	KTP	2		TBD	Call TI	Call TI	Samples Not Available
TLV2217-33KTPRG3	OBSOLETE	PFM	KTP	2		TBD	Call TI	Call TI	Samples Not Available
TLV2217-33KVURG3	ACTIVE	PFM	KVU	3	2500	Green (RoHS & no Sb/Br)	CU SN	Level-3-260C-168 HR	<a href="#">Request Free Samples</a>
TLV2217-33PWR	ACTIVE	TSSOP	PW	20	2000	Green (RoHS & no Sb/Br)	Call TI	Level-1-260C-UNLIM	Contact TI Distributor or Sales Office

Orderable Device	Status <sup>(1)</sup>	Package Type	Package Drawing	Pins	Package Qty	Eco Plan <sup>(2)</sup>	Lead/ Ball Finish	MSL Peak Temp <sup>(3)</sup>	Samples (Requires Login)
TLV2217-33PWRE4	ACTIVE	TSSOP	PW	20	2000	Green (RoHS & no Sb/Br)	Call TI	Level-1-260C-UNLIM	Contact TI Distributor or Sales Office
TLV2217-33PWRG4	ACTIVE	TSSOP	PW	20	2000	Green (RoHS & no Sb/Br)	Call TI	Level-1-260C-UNLIM	Contact TI Distributor or Sales Office

<sup>(1)</sup> The marketing status values are defined as follows:

**ACTIVE:** Product device recommended for new designs.

**LIFEBUY:** TI has announced that the device will be discontinued, and a lifetime-buy period is in effect.

**NRND:** Not recommended for new designs. Device is in production to support existing customers, but TI does not recommend using this part in a new design.

**PREVIEW:** Device has been announced but is not in production. Samples may or may not be available.

**OBSELETE:** TI has discontinued the production of the device.

<sup>(2)</sup> Eco Plan - The planned eco-friendly classification: Pb-Free (RoHS), Pb-Free (RoHS Exempt), or Green (RoHS & no Sb/Br) - please check <http://www.ti.com/productcontent> for the latest availability information and additional product content details.

**TBD:** The Pb-Free/Green conversion plan has not been defined.

**Pb-Free (RoHS):** TI's terms "Lead-Free" or "Pb-Free" mean semiconductor products that are compatible with the current RoHS requirements for all 6 substances, including the requirement that lead not exceed 0.1% by weight in homogeneous materials. Where designed to be soldered at high temperatures, TI Pb-Free products are suitable for use in specified lead-free processes.

**Pb-Free (RoHS Exempt):** This component has a RoHS exemption for either 1) lead-based flip-chip solder bumps used between the die and package, or 2) lead-based die adhesive used between the die and leadframe. The component is otherwise considered Pb-Free (RoHS compatible) as defined above.

**Green (RoHS & no Sb/Br):** TI defines "Green" to mean Pb-Free (RoHS compatible), and free of Bromine (Br) and Antimony (Sb) based flame retardants (Br or Sb do not exceed 0.1% by weight in homogeneous material)

<sup>(3)</sup> MSL, Peak Temp. -- The Moisture Sensitivity Level rating according to the JEDEC industry standard classifications, and peak solder temperature.

**Important Information and Disclaimer:** The information provided on this page represents TI's knowledge and belief as of the date that it is provided. TI bases its knowledge and belief on information provided by third parties, and makes no representation or warranty as to the accuracy of such information. Efforts are underway to better integrate information from third parties. TI has taken and continues to take reasonable steps to provide representative and accurate information but may not have conducted destructive testing or chemical analysis on incoming materials and chemicals. TI and TI suppliers consider certain information to be proprietary, and thus CAS numbers and other limited information may not be available for release.

In no event shall TI's liability arising out of such information exceed the total purchase price of the TI part(s) at issue in this document sold by TI to Customer on an annual basis.

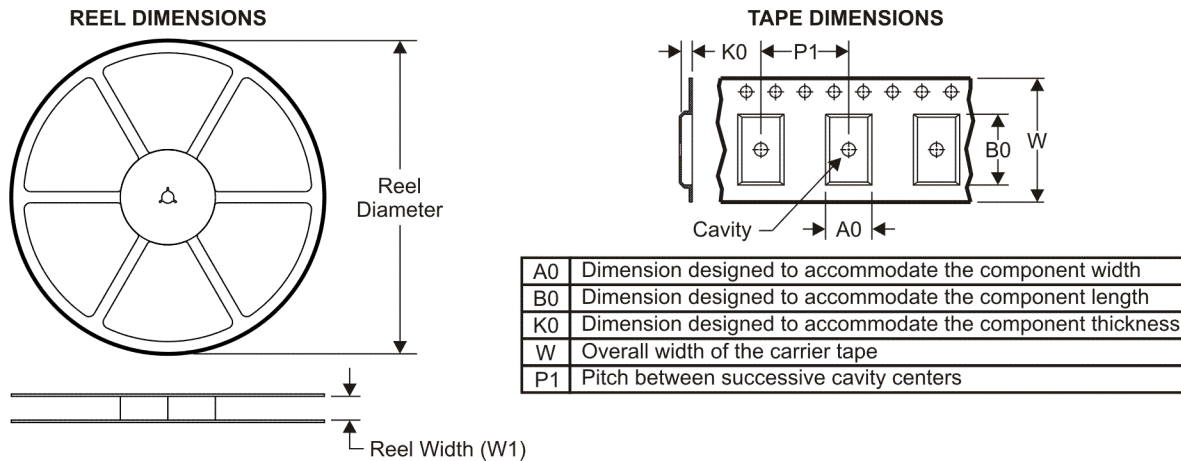
**TAPE AND REEL INFORMATION**

**QUADRANT ASSIGNMENTS FOR PIN 1 ORIENTATION IN TAPE**

\*All dimensions are nominal

Device	Package Type	Package Drawing	Pins	SPQ	Reel Diameter (mm)	Reel Width W1 (mm)	A0 (mm)	B0 (mm)	K0 (mm)	P1 (mm)	W (mm)	Pin1 Quadrant
TLV2217-18KVURG3	PFM	KVU	3	2500	330.0	16.4	6.9	10.5	2.7	8.0	16.0	Q2
TLV2217-25KVURG3	PFM	KVU	3	1	330.0	16.4	6.9	10.5	2.7	8.0	16.0	Q2
TLV2217-25PWR	TSSOP	PW	20	2000	330.0	16.4	6.95	7.1	1.6	8.0	16.0	Q1
TLV2217-33KVURG3	PFM	KVU	3	2500	330.0	16.4	6.9	10.5	2.7	8.0	16.0	Q2
TLV2217-33PWR	TSSOP	PW	20	2000	330.0	16.4	6.95	7.1	1.6	8.0	16.0	Q1



**TAPE AND REEL BOX DIMENSIONS**

\*All dimensions are nominal

Device	Package Type	Package Drawing	Pins	SPQ	Length (mm)	Width (mm)	Height (mm)
TLV2217-18KVURG3	PFM	KVU	3	2500	340.0	340.0	38.0
TLV2217-25KVURG3	PFM	KVU	3	1	340.0	340.0	38.0
TLV2217-25PWR	TSSOP	PW	20	2000	346.0	346.0	33.0
TLV2217-33KVURG3	PFM	KVU	3	2500	340.0	340.0	38.0
TLV2217-33PWR	TSSOP	PW	20	2000	346.0	346.0	33.0

KTP (R-PSFM-G2)

PowerFLEX™ PLASTIC FLANGE-MOUNT PACKAGE

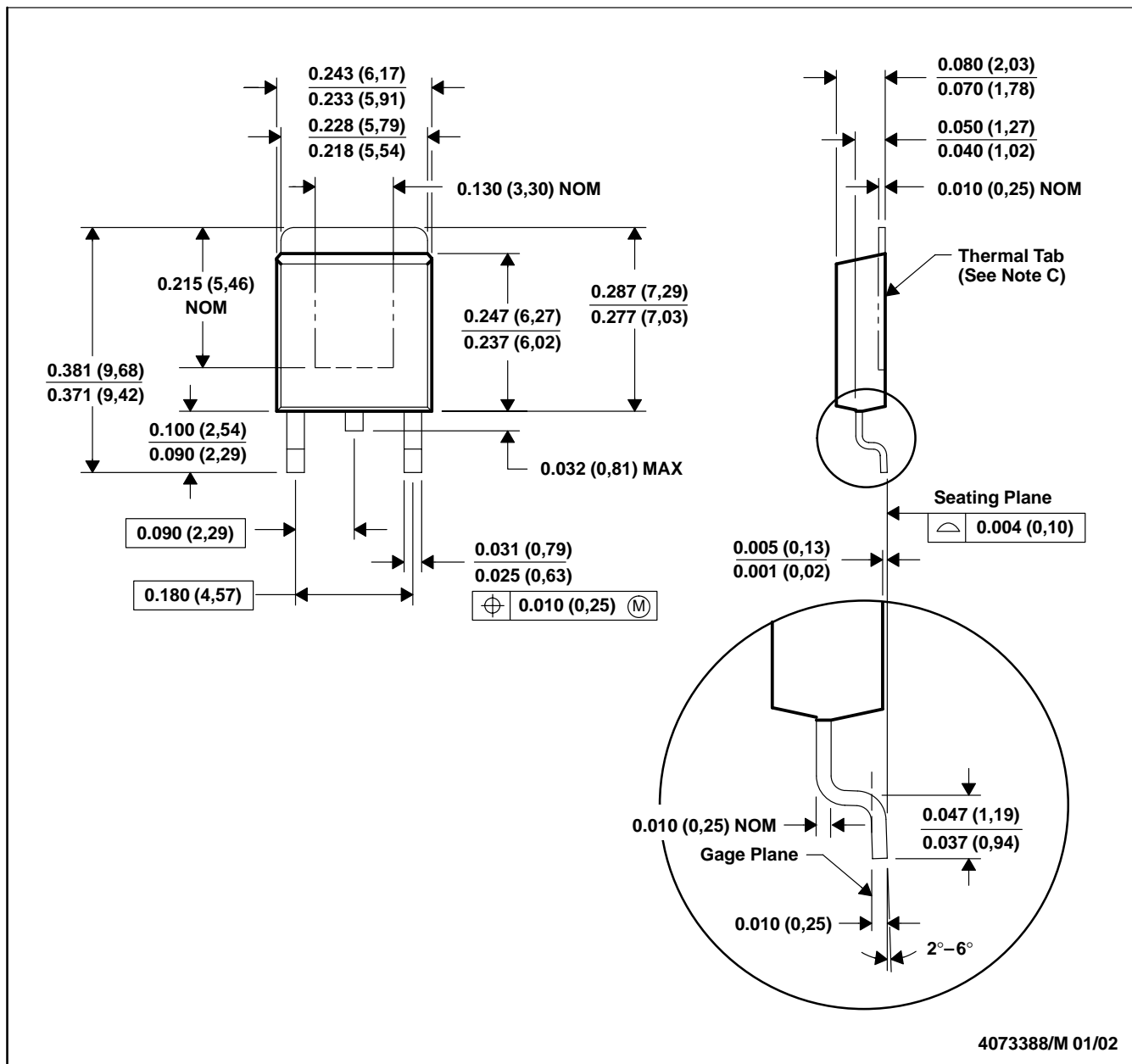

- NOTES: A. All linear dimensions are in inches (millimeters).  
 B. This drawing is subject to change without notice.  
 C. The center lead is in electrical contact with the thermal tab.  
 D. Dimensions do not include mold protrusions, not to exceed 0.006 (0,15).  
 E. Falls within JEDEC TO-252 variation AC.

PowerFLEX is a trademark of Texas Instruments.



KCS (R-PSFM-T3)

PLASTIC FLANGE-MOUNT PACKAGE

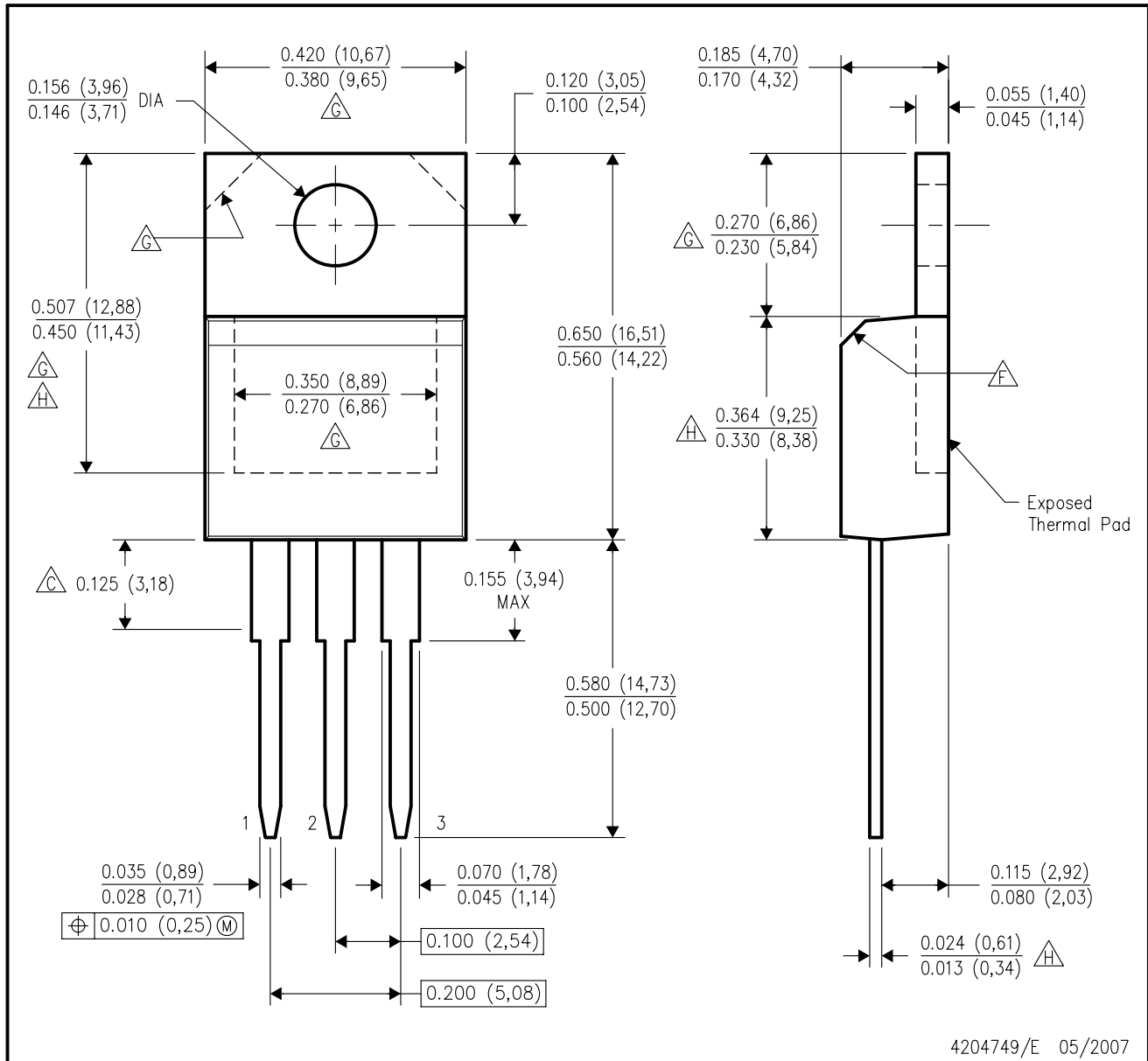



- NOTES:
- A. All linear dimensions are in inches (millimeters).
  - B. This drawing is subject to change without notice.
  - C. Lead dimensions are not controlled within this area.
  - D. All lead dimensions apply before solder dip.
  - E. The center lead is in electrical contact with the mounting tab.
  - F. The chamfer is optional.
  - G. Thermal pad contour optional within these dimensions.
  - H. Falls within JEDEC TO-220 variation AB, except minimum lead thickness, minimum exposed pad length, and maximum body length.

# MECHANICAL DATA

KVU (R-PSFM-G3)

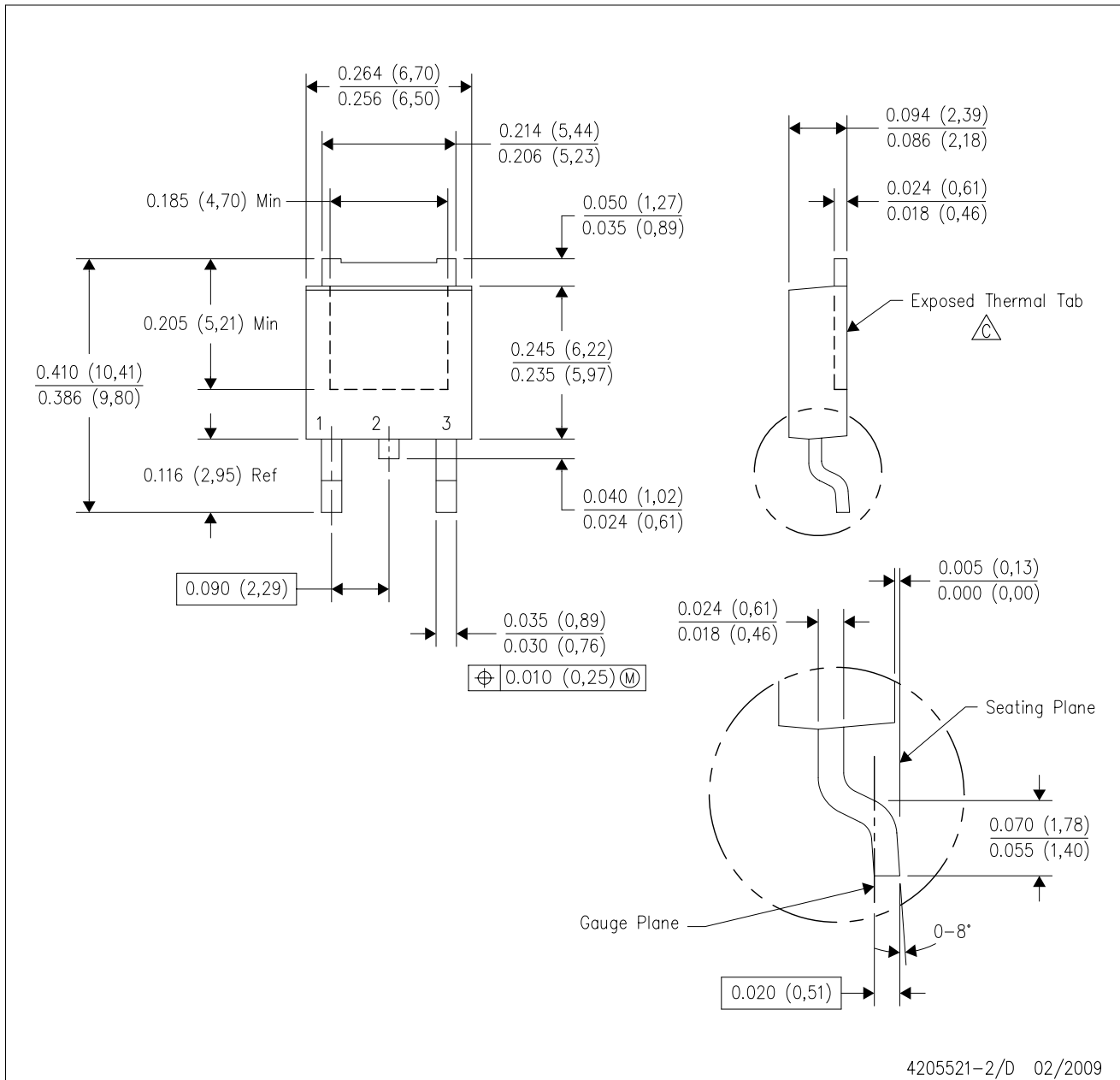
PLASTIC FLANGE-MOUNT PACKAGE



- NOTES:
- A. All linear dimensions are in inches (millimeters).
  - B. This drawing is subject to change without notice.
  -  The center lead is in electrical contact with the exposed thermal tab.
  - D. Body Dimensions do not include mold flash or protrusions. Mold flash and protrusion shall not exceed 0.006 (0,15) per side.
  - E. Falls within JEDEC TO-252 variation AA.

KC (R-PSFM-T3)

PLASTIC FLANGE-MOUNT PACKAGE

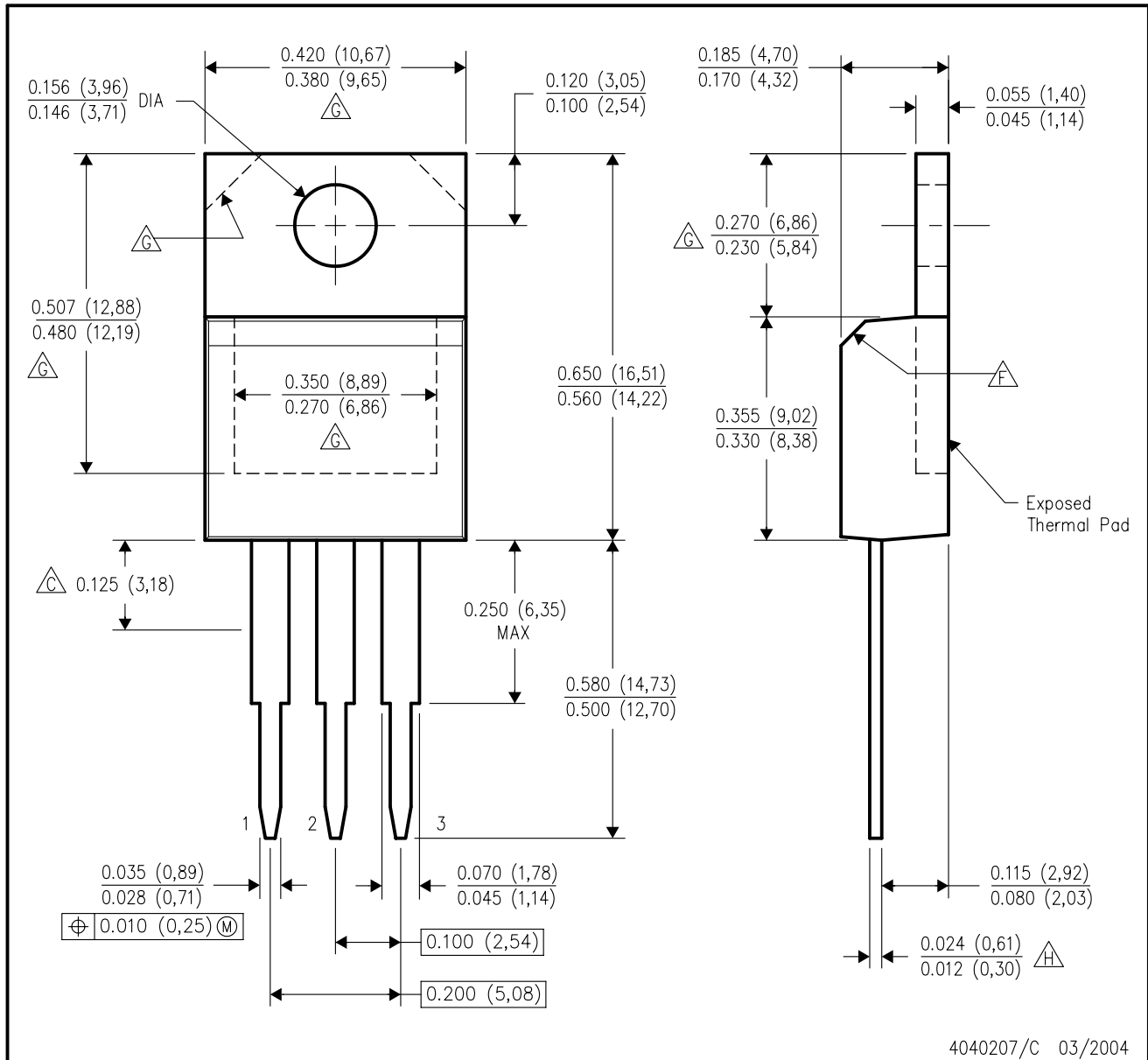

- NOTES:
- A. All linear dimensions are in inches (millimeters).
  - B. This drawing is subject to change without notice.
  - C. Lead dimensions are not controlled within this area.
  - D. All lead dimensions apply before solder dip.
  - E. The center lead is in electrical contact with the mounting tab.
  - F. The chamfer is optional.
  - G. Thermal pad contour optional within these dimensions.
  - H. Falls within JEDEC TO-220 variation AB, except minimum lead thickness.

PW (R-PDSO-G\*\*)

PLASTIC SMALL-OUTLINE PACKAGE

14 PINS SHOWN



4040064/F 01/97

- NOTES: A. All linear dimensions are in millimeters.  
 B. This drawing is subject to change without notice.  
 C. Body dimensions do not include mold flash or protrusion not to exceed 0,15.  
 D. Falls within JEDEC MO-153

## IMPORTANT NOTICE

Texas Instruments Incorporated and its subsidiaries (TI) reserve the right to make corrections, modifications, enhancements, improvements, and other changes to its products and services at any time and to discontinue any product or service without notice. Customers should obtain the latest relevant information before placing orders and should verify that such information is current and complete. All products are sold subject to TI's terms and conditions of sale supplied at the time of order acknowledgment.

TI warrants performance of its hardware products to the specifications applicable at the time of sale in accordance with TI's standard warranty. Testing and other quality control techniques are used to the extent TI deems necessary to support this warranty. Except where mandated by government requirements, testing of all parameters of each product is not necessarily performed.

TI assumes no liability for applications assistance or customer product design. Customers are responsible for their products and applications using TI components. To minimize the risks associated with customer products and applications, customers should provide adequate design and operating safeguards.

TI does not warrant or represent that any license, either express or implied, is granted under any TI patent right, copyright, mask work right, or other TI intellectual property right relating to any combination, machine, or process in which TI products or services are used. Information published by TI regarding third-party products or services does not constitute a license from TI to use such products or services or a warranty or endorsement thereof. Use of such information may require a license from a third party under the patents or other intellectual property of the third party, or a license from TI under the patents or other intellectual property of TI.

Reproduction of TI information in TI data books or data sheets is permissible only if reproduction is without alteration and is accompanied by all associated warranties, conditions, limitations, and notices. Reproduction of this information with alteration is an unfair and deceptive business practice. TI is not responsible or liable for such altered documentation. Information of third parties may be subject to additional restrictions.

Resale of TI products or services with statements different from or beyond the parameters stated by TI for that product or service voids all express and any implied warranties for the associated TI product or service and is an unfair and deceptive business practice. TI is not responsible or liable for any such statements.

TI products are not authorized for use in safety-critical applications (such as life support) where a failure of the TI product would reasonably be expected to cause severe personal injury or death, unless officers of the parties have executed an agreement specifically governing such use. Buyers represent that they have all necessary expertise in the safety and regulatory ramifications of their applications, and acknowledge and agree that they are solely responsible for all legal, regulatory and safety-related requirements concerning their products and any use of TI products in such safety-critical applications, notwithstanding any applications-related information or support that may be provided by TI. Further, Buyers must fully indemnify TI and its representatives against any damages arising out of the use of TI products in such safety-critical applications.

TI products are neither designed nor intended for use in military/aerospace applications or environments unless the TI products are specifically designated by TI as military-grade or "enhanced plastic." Only products designated by TI as military-grade meet military specifications. Buyers acknowledge and agree that any such use of TI products which TI has not designated as military-grade is solely at the Buyer's risk, and that they are solely responsible for compliance with all legal and regulatory requirements in connection with such use.

TI products are neither designed nor intended for use in automotive applications or environments unless the specific TI products are designated by TI as compliant with ISO/TS 16949 requirements. Buyers acknowledge and agree that, if they use any non-designated products in automotive applications, TI will not be responsible for any failure to meet such requirements.

Following are URLs where you can obtain information on other Texas Instruments products and application solutions:

<b>Products</b>		<b>Applications</b>	
Amplifiers	<a href="http://amplifier.ti.com">amplifier.ti.com</a>	Audio	<a href="http://www.ti.com/audio">www.ti.com/audio</a>
Data Converters	<a href="http://dataconverter.ti.com">dataconverter.ti.com</a>	Automotive	<a href="http://www.ti.com/automotive">www.ti.com/automotive</a>
DLP® Products	<a href="http://www.dlp.com">www.dlp.com</a>	Communications and Telecom	<a href="http://www.ti.com/communications">www.ti.com/communications</a>
DSP	<a href="http://dsp.ti.com">dsp.ti.com</a>	Computers and Peripherals	<a href="http://www.ti.com/computers">www.ti.com/computers</a>
Clocks and Timers	<a href="http://www.ti.com/clocks">www.ti.com/clocks</a>	Consumer Electronics	<a href="http://www.ti.com/consumer-apps">www.ti.com/consumer-apps</a>
Interface	<a href="http://interface.ti.com">interface.ti.com</a>	Energy	<a href="http://www.ti.com/energy">www.ti.com/energy</a>
Logic	<a href="http://logic.ti.com">logic.ti.com</a>	Industrial	<a href="http://www.ti.com/industrial">www.ti.com/industrial</a>
Power Mgmt	<a href="http://power.ti.com">power.ti.com</a>	Medical	<a href="http://www.ti.com/medical">www.ti.com/medical</a>
Microcontrollers	<a href="http://microcontroller.ti.com">microcontroller.ti.com</a>	Security	<a href="http://www.ti.com/security">www.ti.com/security</a>
RFID	<a href="http://www.ti-rfid.com">www.ti-rfid.com</a>	Space, Avionics & Defense	<a href="http://www.ti.com/space-avionics-defense">www.ti.com/space-avionics-defense</a>
RF/IF and ZigBee® Solutions	<a href="http://www.ti.com/lprf">www.ti.com/lprf</a>	Video and Imaging	<a href="http://www.ti.com/video">www.ti.com/video</a>
		Wireless	<a href="http://www.ti.com/wireless-apps">www.ti.com/wireless-apps</a>

Mailing Address: Texas Instruments, Post Office Box 655303, Dallas, Texas 75265  
Copyright © 2010, Texas Instruments Incorporated