

# Compact 690 VAC power line EMC/EMI filter



- High current 3-phase filter up to 2300 A
- Extremely compact and light weight design
- Minimum installation foot print
- Performance optimised for standard purpose applications
- FN 3310 HV series without Cy capacitors to ground
- FN 3311 HVIT versions for use in IT power networks



### Performance indicators

Attenuation performance



Rated current [A]



## Technical specifications

<b>Maximum continuous operating voltage</b>	3x 760/440 VAC for FN 3311 HV 3x 760 VAC for FN 3310 HV and FN 3311 HVIT
<b>Operating frequency</b>	DC to 60 Hz
<b>Rated currents</b>	250 to 2300 A @ 50°C
<b>High potential test voltage</b>	P → E 3.0 kVAC for 2 s (FN 3310 HV/FN 3311 HVIT 3.35 kVAC for 2 s) P → P 3.45 kVDC for 2 s
<b>Protection category</b>	IP 00
<b>Overload capability</b>	4x rated current at switch on, max. 8 sec 1.5x rated current for 1 minute, once per hour
<b>Temperature range (operation and storage)</b>	-40°C to +100°C
<b>Climatic category</b>	40/100/21 acc. to IEC 60068-1
<b>Terminals/Housing</b>	Ni plated cu bars/Metal
<b>Flammability corresponding to</b>	UL 94V-0
<b>Design corresponding to</b>	UL 1283, CSA 22.2 No. 8, IEC/EN 60939, EN 60721-3

### Approvals



The FN 3311 HV/FN 3310 HV product series of standard EMC/EMI filters are based on Schaffner's many years of expertise in filter design for all types of converter and inverter applications. Installed between the PV inverter and the power grid, the FN 3311HV and FN 3310HV AC filters are used to influence positively the conducted emissions on the grid side to help to comply with the required emission standards.

### Features and benefits

The FN 3311 HV/FN 3310 HV series are the most compact dedicated high current AC filters, not only suitable for PV applications, but being an optimum fit with most modern PV inverter topologies. In addition the filters can be configured in a very flexible way to fulfil custom specific application requirements.

All FN 3311 HV/FN 3310 HV come in unsymmetrical housings, which help to prevent inverse installation and wrong electrical connection. The AC filters FN 3311 HV/FN 3310 HV are key to meet the stringent international standards for electromagnetic compatibility and help to ensure a reliable and fault-free operation of the entire PV system.

### Typical applications

The FN 3311 HV/FN 3310 HV series are primarily designed for all kind of power line connected converter and inverter applications between 250 and 2'300 A. However, they are optimised for PV inverter and can potentially also be applied for general purpose motor drives applications.

### Typical electrical schematic FN 3311 HV

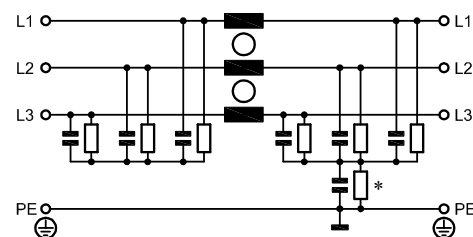

- \* - FN 3311 HVIT series without resistor to PE
- FN 3310 HV series without resistor and capacitor to PE

### Filter selection table

Filters */**		Rated current @ 50°C [A]	Typical inverter AC power rating*** [kVA]	Leakage current**** @ 760 VAC/50 Hz [mA]	Power loss @ 25°C/DC [W]	Weight [kg]
<b>FN 3311 HV with Cy caps</b>	<b>FN 3311 HVIT with Cy caps</b>					
FN 3311 HV-250-99-C18-R55	FN 3311 HVIT-250-99-C18-R5	250	140	0.09	18	2.7
FN 3311 HV-400-99-C18-R55	FN 3311 HVIT-400-99-C18-R5	400	220	0.09	30	3.3
FN 3311 HV-600-99-C18-R55	FN 3311 HVIT-600-99-C18-R5	600	330	0.09	33	4.5
FN 3311 HV-1000-99-C18-R55	FN 3311 HVIT-1000-99-C18-R5	1000	550	0.09	70	6.1
FN 3311 HV-1500-99-C18-R55	FN 3311 HVIT-1500-99-C18-R5	1500	830	0.09	133	11.0
FN 3311 HV-2300-99-C18-R55	FN 3311 HVIT-2300-99-C18-R5	2300	1250	0.09	201	18.0
<b>FN 3310 without Cy caps</b>						
FN 3310 HV-250-99-R5		250	140		18	2.7
FN 3310 HV-400-99-R5		400	220		30	3.3
FN 3310 HV-600-99-R5		600	330		33	4.5
FN 3310 HV-1000-99-R5		1000	550		70	6.1
FN 3310 HV-1500-99-R5		1500	830		133	11.0
FN 3310 HV-2300-99-R5		2300	1250		201	18.0

\* Filters with higher current ratings available upon request.

\*\* Filters with reduced Cy capacitance to ground for high asymmetrical currents and higher voltages available upon request.

\*\*\* Calculated at rated current, 690 VAC and cos phi = 0.8. The exact value depends upon the efficiency of the drive, the motor and the entire application.£

\*\*\*\* Leakage current according IEC 60939-1

### Typical filter attenuation curves

Per CISPR 17; A=50 Ω/50 Ω sym; B=50 Ω/50 Ω asym

FN 3311 HV-250...2300-99-C18-R5  
and  
FN 3311 HVIT-250...2300-99-C18-R55

FN 3310 HV-250...2300-99-R5

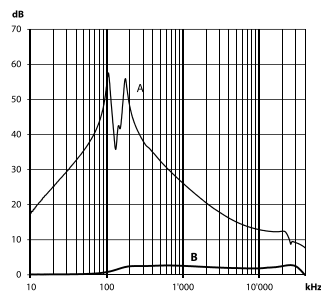
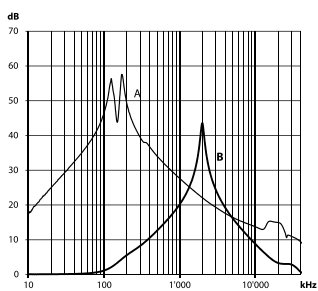

### Typical block schematic

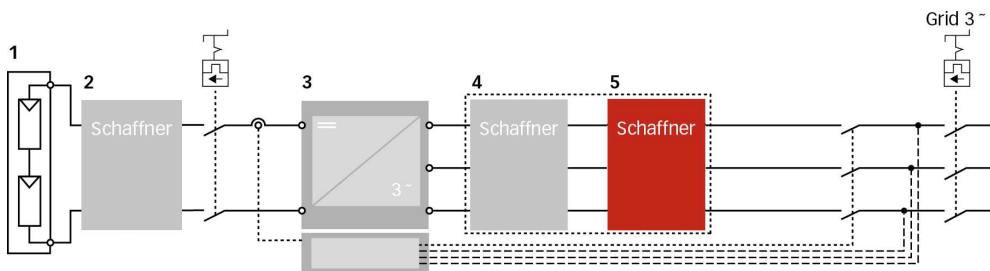

1 PV modules

2 Schaffner DC filter FN 22xx

3 Central Inverter

4 Schaffner magnetic components

5 Schaffner AC EMC/EMI filter FN 3xxx

Important note: depending on the grounding scheme of the solar power system, including the solar panel and the grid side transformer, the appropriate DC- and AC EMC/EMI filter version need to be selected. For support, please contact your local Schaffner sales office or partner.

## Mechanical data

250 to 2'300 A types

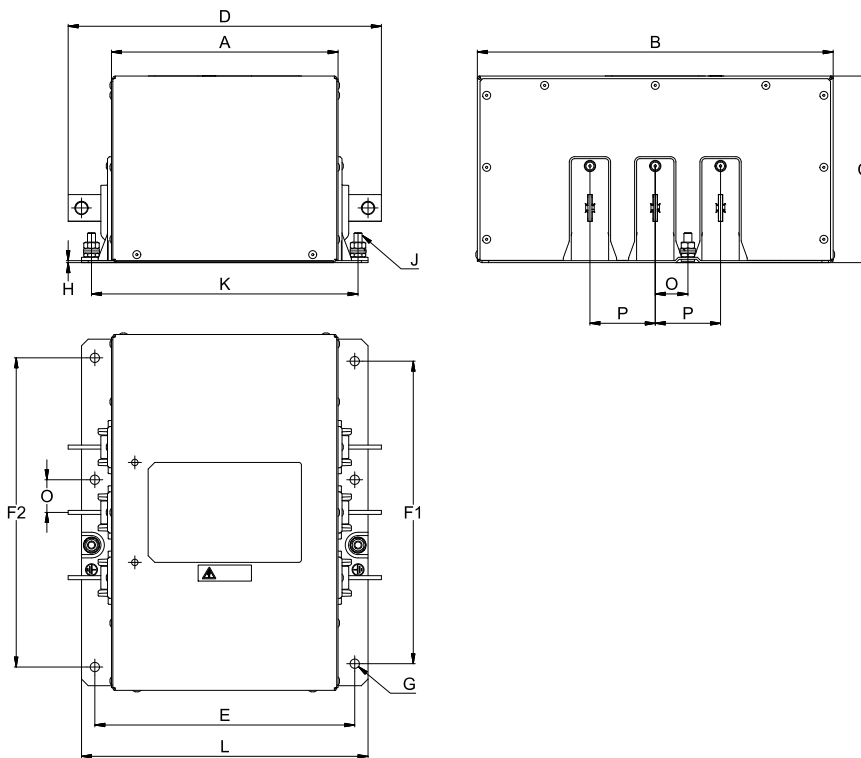

## Busbar connections

250 to 1'000 A types

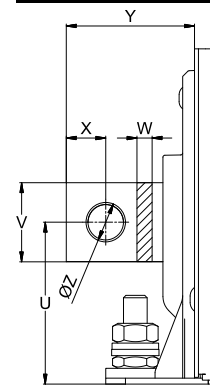

1'500 A types

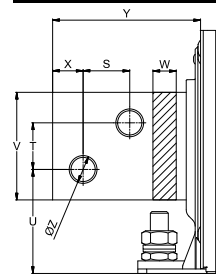

2'300 A types

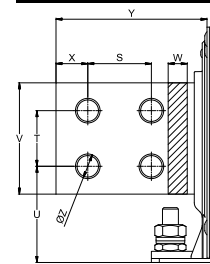

**Note:** all FN 3311 and FN 3310 provide unsymmetrical mounting hole patterns to prevent inverse filter installation in the field.

## Dimensions of FN 3311 HV and FN 3310 HV series

(the FN 3311 HMT versions have the same dimensions as the FN 3311 HV)

	250 A	400 A	600 A	1'000 A	1'500 A	2'300 A
<b>A</b>	170	175	190	190	195	220
<b>B</b>	267	280	290	290	310	320
<b>C</b>	140	140	140	140	150	165
<b>D</b>	235	250	265	305	360	410
<b>E</b>	195	205	220	220	240	265
<b>F1</b>	227	240	250	250	270	275
<b>F2</b>	232	245	255	255	275	280
<b>G</b>	Ø7 (6x)	Ø9 (6x)	Ø9 (6x)	Ø9 (6x)	Ø11 (6x)	Ø11 (6x)
<b>H</b>	1.5	2	2.5	2.5	2.5	2.5
<b>J</b>	M6 (2x)	M8 (2x)	M8 (2x)	M8 (2x)	M10 (2x)	M10 (2x)
<b>K</b>	200 (+/- 1)	210 (+/- 1)	225 (+/- 1)	225 (+/- 1)	241 (+/- 1)	266 (+/- 1)
<b>L</b>	215	230	245	245	265	290
<b>O</b>	24.5	27	29.5	29.5	34.8	40
<b>P</b>	49 (+/- 0.5)	54 (+/- 0.5)	59 (+/- 0.5)	59 (+/- 0.5)	69.5 (+/- 0.5)	80 (+/- 0.5)
<b>S</b>					26	40
<b>T</b>					26	35
<b>U</b>	41	46	50	53	58	60.5
<b>V</b>	20	25	25	40	60	70
<b>W</b>	3	4	8	8	10	15
<b>X</b>	10	12.5	12.5	20	17	20
<b>Y</b>	32.5	37.5	37.5	57.5	82.5	95
<b>Z</b>	Ø9	Ø11	Ø11	Ø13.5	Ø13.5	Ø13.5

All dimensions in mm; 1 inch = 25.4 mm

Tolerances according: ISO 2768-m/EN 22768-m, if not stated otherwise

Please see the brochure "Basics in EMC and Power Quality" on our website [www.schaffner.com](http://www.schaffner.com) to find more details on filter connectors.



## Headquarters, global innovation and development

### Switzerland

#### Schaffner Group

Nordstrasse 11  
4542 Luterbach  
T +41 32 681 66 26  
[info@schaffner.com](mailto:info@schaffner.com)  
[www.schaffner.com](http://www.schaffner.com)



## Sales and application centers

### China

#### Schaffner EMC Ltd. Shanghai

T20-3 C, No 565 Chuangye Road,  
Pudong district  
201201 Shanghai  
T +86 21 3813 9500  
[cschina@schaffner.com](mailto:cschina@schaffner.com)  
[www.schaffner.com.cn](http://www.schaffner.com.cn)

### Finland

#### Schaffner Oy

Sauvonrinne 19 H  
08500 Lohja  
T +358 50 468 7284  
[finlandsales@schaffner.com](mailto:finlandsales@schaffner.com)

### France

#### Schaffner EMC S.A.S.

16-20 Rue Louis Rameau  
95875 Bezons  
T +33 1 34 34 30 60  
F +33 1 39 47 02 28  
[francesales@schaffner.com](mailto:francesales@schaffner.com)

### Germany

#### Schaffner Deutschland GmbH

Schoemperlenstrasse 12B  
76185 Karlsruhe  
T +49 721 56910  
F +49 721 569110  
[germanysales@schaffner.com](mailto:germanysales@schaffner.com)

### India

#### Schaffner India Pvt. Ltd

REGUS WORLD TRADE CENTRE  
WTC, 22nd Floor Unit No 2238, Brigade  
Gateway Campus, 26/1, Dr. Rajkumar Road  
Malleswaram (W)  
560055 Bangalore  
T +91 80 67935355  
[indiasales@schaffner.com](mailto:indiasales@schaffner.com)

### Italy

#### Schaffner EMC S.r.l.

Via Ticino, 30  
20900 Monza (MB)  
T +39 039 21 41 070  
[italysales@schaffner.com](mailto:italysales@schaffner.com)

### Japan

#### Schaffner EMC K.K.

1-32-12, Kamiyama, Setagaya-ku  
7F Mitsui-seimei Sangenjaya Bldg.  
154-0011 Tokyo  
T +81 3 5712 3650  
F +81 3 5712 3651  
[japansales@schaffner.com](mailto:japansales@schaffner.com)  
[www.schaffner.jp](http://www.schaffner.jp)

### Singapore

#### Schaffner EMC Pte Ltd.

#05-09, Kg Ubi Ind. Estate  
408705 Singapore  
T +65 6377 3283  
F +65 6377 3281  
[singaporesales@schaffner.com](mailto:singaporesales@schaffner.com)

### Spain

#### Schaffner EMC España

Calle Caléndula 93, Miniparc III, Edificio E  
El Soto de Moraleja, Alcobendas  
28109 Madrid  
T +34 917 912 900  
F +34 917 912 901  
[spainsales@schaffner.com](mailto:spainsales@schaffner.com)

### Sweden

#### Schaffner EMC AB

Tegeluddsvägen 76, 2tr  
115 28 Stockholm  
T +46 8 5050 2425  
[swedensales@schaffner.com](mailto:swedensales@schaffner.com)  
[www.schaffner.com](http://www.schaffner.com)

### Switzerland

#### Schaffner EMV AG

Nordstrasse 11  
4542 Luterbach  
T +41 32 681 66 26  
[switzerlandsales@schaffner.com](mailto:switzerlandsales@schaffner.com)

### Taiwan R.O.C.

#### Schaffner EMV Ltd.

20 Floor-2, No 97, Section 1, XinTai 5th Road  
22175 XiZhi District New Taipei City 22175  
T +886 2 2697 5500  
F +886 2 2697 5533  
[taiwansales@schaffner.com](mailto:taiwansales@schaffner.com)  
[www.schaffner.com.tw](http://www.schaffner.com.tw)

### Thailand

#### Schaffner EMC Co. Ltd.

Northern Region Industrial Estate  
67 Moo 4 Tambon Ban Klang  
Amphur Muangng P.O. Box 14  
51000 Lamphun  
T +66 53 58 11 04  
F +66 53 58 10 19  
[thailandsales@schaffner.com](mailto:thailandsales@schaffner.com)

### United Kingdom

#### Schaffner Ltd.

5 Ashville Way, Molly Millars Lane  
Wokingham  
RG41 2PL Berkshire  
T +44 118 9770070  
F +44 118 9792969  
[uksales@schaffner.com](mailto:uksales@schaffner.com)

### USA

#### Schaffner EMC Inc.

52 Mayfield Avenue  
08837 Edison, New Jersey  
T +1 800 367 5566  
T +1 732 225 9533  
F +1 732 225 4789  
[usasales@schaffner.com](mailto:usasales@schaffner.com)  
[www.schaffnerusa.com](http://www.schaffnerusa.com)

#### Schaffner North America

6722 Thirlane Road  
24019 Roanoke, Virginia  
T +1 276 228 7943  
F +1 276 228 7953

#### Schaffner North America

823 Fairview Road  
24382 Wytheville, Virginia  
T +1 276 228 7943  
F +1 276 228 7258

To find your local partner within Schaffner's global network: [www.schaffner.com](http://www.schaffner.com)

© 2018 Schaffner Group

The content of this document has been carefully checked and understood. However, neither Schaffner nor its subsidiaries assume any liability whatsoever for any errors or inaccuracies of this document and the consequences thereof. Published specifications are subject to change without notice. Product suitability for any area of application must ultimately be determined by the customer. In all cases, products must never be operated outside their published specifications. Schaffner does not guarantee the availability of all published products. This disclaimer shall be governed by substantive Swiss law and resulting disputes shall be settled by the courts at the place of business of Schaffner Holding AG. Latest publications and a complete disclaimer can be downloaded from the Schaffner website. All trademarks recognized.

# Mouser Electronics

Authorized Distributor

Click to View Pricing, Inventory, Delivery & Lifecycle Information:

## Schaffner:

[FN3310HV-1000-99-R5](#) [FN3310HV-600-99-R5](#) [FN3311HV-400-99-C18-R55](#) [FN3311HVIT-1500-99-C18-R5](#)  
[FN3311HVIT-400-99-C18-R5](#) [FN3310HV-400-99-R5](#) [FN3311HVIT-600-99-C18-R5](#) [FN3311HV-1000-99-C18-R55](#)  
[FN3310HV-250-99-R5](#) [FN3311HVIT-250-99-C18-R5](#) [FN3311HVIT-1500-99-C21-R5](#) [FN3311HV-1500-99-C18-R55](#)  
[FN3311HVIT-2300-99-C18-R5](#) [FN3311HV-250-99-C18-R55](#) [FN3311HV-600-99-C18-R55](#) [FN3311HVIT-1000-99-C18-](#)  
[R5](#) [FN3311HV-2300-99-C18-R55](#) [FN3310HV-1500-99-R5](#) [FN3310HV-2300-99-R5](#)