

ZOE-30-ZOOM

Ø30 mm zoomable lens with infinitely adjustable beam from 13 to 42 degrees

SPECIFICATION:

Dimensions	Ø 31.6 mm
Height	20.3 mm
ROHS compliant	yes ⓘ



MATERIALS:

Component	Type	Material	Colour	Finish	Length
C17716_ZOE-30-ZOOM	Single lens	PMMA	clear		28.0
C17717_ZOE-30-ZOOM-SUB	Sublens	PC	clear		31.6

ORDERING INFORMATION:

Quantities for one set:

Single lens	1
Sublens	1

Component		Qty in box	MOQ	MPQ	Box weight (kg)
C17716_ZOE-30-ZOOM	Single lens	1560	104	104	12.1
» Box size: 480 x 280 x 300 mm					
C17717_ZOE-30-ZOOM-SUB	Sublens	1560	104	104	3.6
» Box size: 480 x 280 x 115 mm					

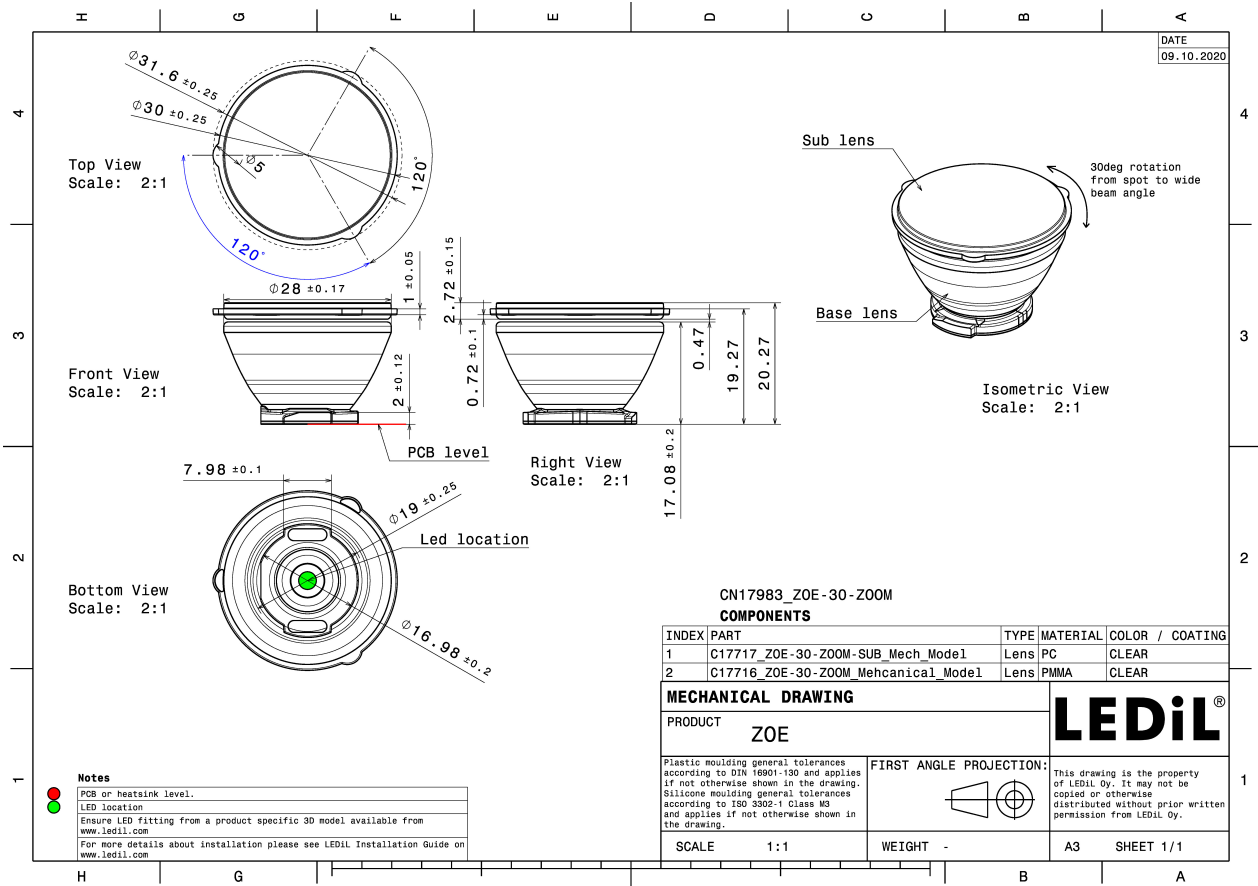

See also our general installation guide: www.ledil.com/installation_guide

OPTICAL RESULTS (MEASURED):



LED XHP50.3 HI
 FWHM / FWTM 16.0 + 43.0° / 34.0 + 67.0°
 Efficiency 76 %
 Peak intensity 5.9 cd/lm
 LEDs/each optic 1
 Light colour/type White
 Required components:

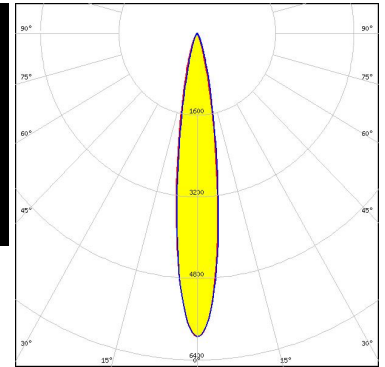

Light distribution files



LED XM-L3
 FWHM / FWTM 15.0 + 43.0° / 31.0 + 64.0°
 Efficiency 78 %
 Peak intensity 7.3 cd/lm
 LEDs/each optic 1
 Light colour/type White
 Required components:

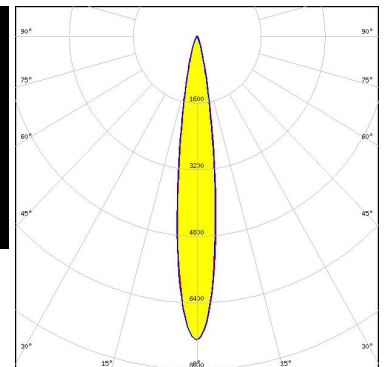

Light distribution files



LED XP-L2
 FWHM / FWTM 16.0 + 43.0° / 32.0 + 66.0°
 Efficiency 75 %
 Peak intensity 6.3 cd/lm
 LEDs/each optic 1
 Light colour/type White
 Required components:

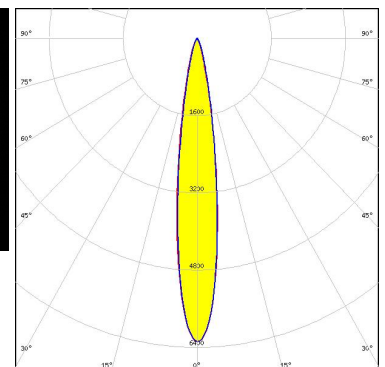

Light distribution files

OPTICAL RESULTS (MEASURED):



LED XP-P
 FWHM / FWTM 9.0 + 40.0° / 19.0 + 57.0°
 Efficiency 80 %
 Peak intensity 19 cd/lm
 LEDs/each optic 1
 Light colour/type White
 Required components:

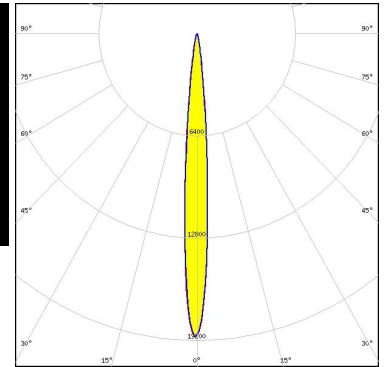

Light distribution files



LED LUXEON HL2X
 FWHM / FWTM 14.0 + 42.0° / 29.0 + 61.0°
 Efficiency 80 %
 Peak intensity 8.8 cd/lm
 LEDs/each optic 1
 Light colour/type White
 Required components:

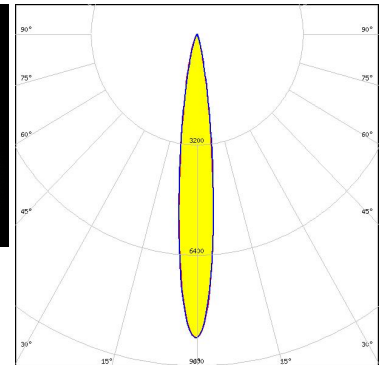
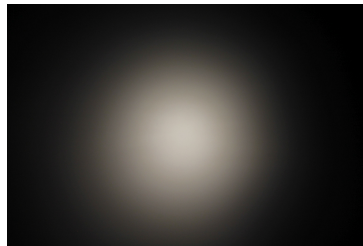

Light distribution files



LED LUXEON HL2Z
 FWHM / FWTM 13.0 + 41.0° / 29.0 + 61.0°
 Efficiency 78 %
 Peak intensity 8.6 cd/lm
 LEDs/each optic 1
 Light colour/type White
 Required components:

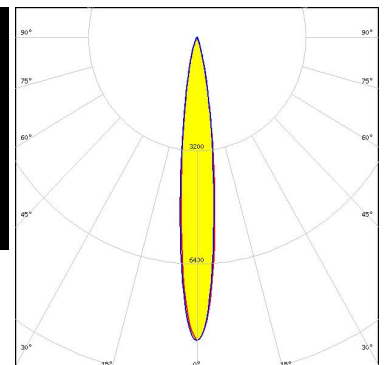

Light distribution files

OPTICAL RESULTS (MEASURED):



LED NVSW319B
FWHM / FWTM 14.0 + 43.0° / 30.0 + 64.0°
Efficiency 80 %
Peak intensity 8 cd/lm
LEDs/each optic 1
Light colour/type White
Required components:

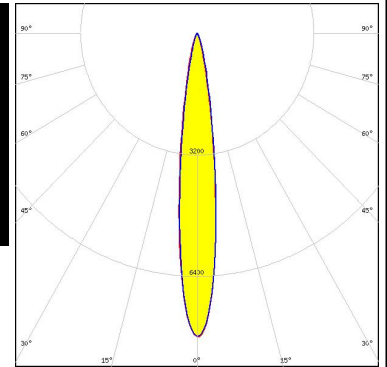
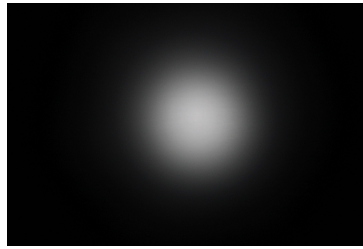

Light distribution files



LED NVSW519A
FWHM / FWTM 17.0 + 43.0° / 35.0 + 65.0°
Efficiency 68 %
Peak intensity 5 cd/lm
LEDs/each optic 1
Light colour/type White
Required components:

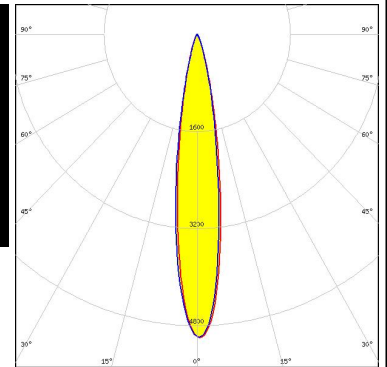

Light distribution files



LED NVSxE21A
FWHM / FWTM 14.0 + 41.0° / 29.0 + 63.0°
Efficiency 76 %
Peak intensity 8.1 cd/lm
LEDs/each optic 1
Light colour/type White
Required components:

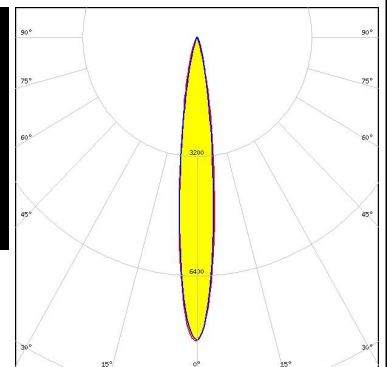

Light distribution files

OPTICAL RESULTS (MEASURED):

OSRAM
Opto Semiconductors

LED OSCONIQ P 3737 (3W version)
 FWHM / FWTM 14.0 + 42.0° / 30.0 + 63.0°
 Efficiency 78 %
 Peak intensity 7.9 cd/lm
 LEDs/each optic 1
 Light colour/type White
 Required components:

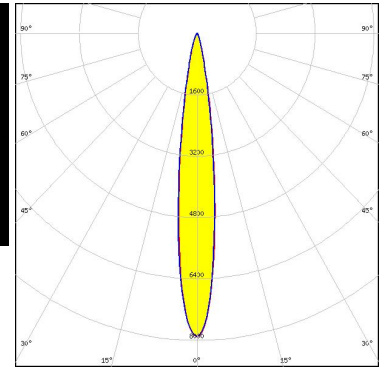

Light distribution files

OSRAM
Opto Semiconductors

LED OSLOM Square CSSRM2/CSSRM3
 FWHM / FWTM 12.0 + 41.0° / 24.0 + 60.0°
 Efficiency 78 %
 Peak intensity 11.8 cd/lm
 LEDs/each optic 1
 Light colour/type White
 Required components:

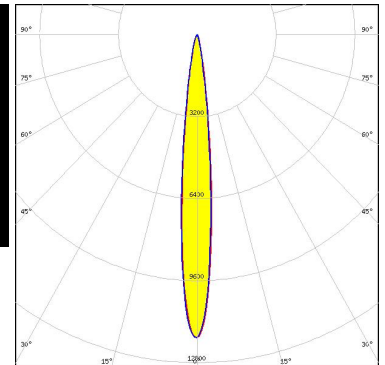

Light distribution files

OSRAM
Opto Semiconductors

LED OSLOM Square Flat
 FWHM / FWTM 10.0 + 41.0° / 23.0 + 61.0°
 Efficiency 75 %
 Peak intensity 12.2 cd/lm
 LEDs/each optic 1
 Light colour/type White
 Required components:

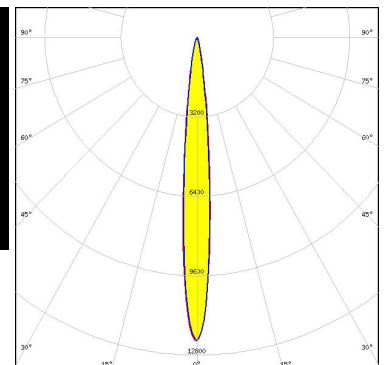

Light distribution files

OPTICAL RESULTS (SIMULATED):



LED XHP35 HD
FWHM / FWTM 18.0 + 40.0° / 37.0 + 67.0°
Efficiency 80 %
Peak intensity 5.5 cd/lm
LEDs/each optic 1
Light colour/type White
Required components:

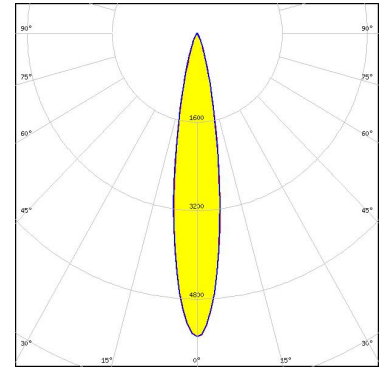

Light distribution files



LED XHP35.2 HI
FWHM / FWTM 16.0 + 38.0° / 31.0 + 62.0°
Efficiency 92 %
Peak intensity 8 cd/lm
LEDs/each optic 1
Light colour/type White
Required components:

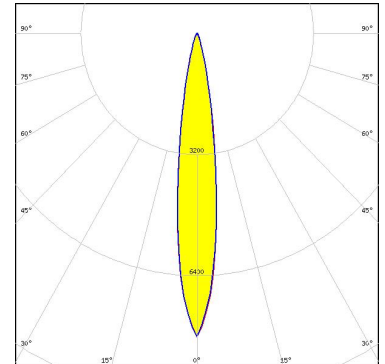

Light distribution files



LED XP-L HI
FWHM / FWTM 12.0 + 40.0° / 26.0 + 63.0°
Efficiency 84 %
Peak intensity 11.4 cd/lm
LEDs/each optic 1
Light colour/type White
Required components:

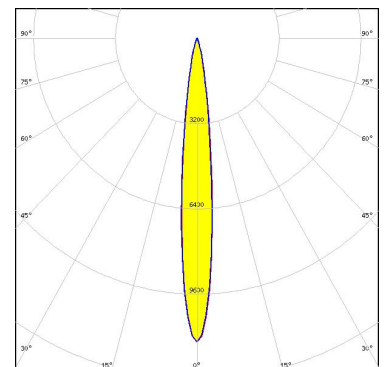

Light distribution files

OPTICAL RESULTS (SIMULATED):



LED SST-40
FWHM / FWTM 16.0 + 40.0° / 34.0 + 66.0°
Efficiency 90 %
Peak intensity 6.8 cd/lm
LEDs/each optic 1
Light colour/type White
Required components:

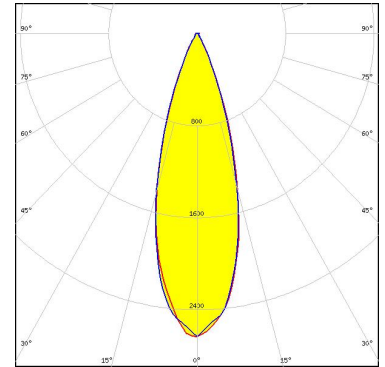

Light distribution files



LED NV4WB35AM
FWHM / FWTM 16.0 + 38.0° / 30.0 + 60.0°
Efficiency 92 %
Peak intensity 8.2 cd/lm
LEDs/each optic 1
Light colour/type White
Required components:

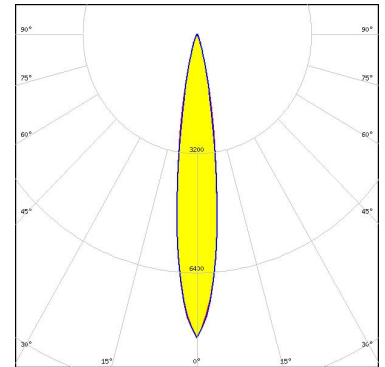

Light distribution files



LED OSOLON Square Flat
FWHM / FWTM 11.0 + 40.0° / 24.0 + 63.0°
Efficiency 79 %
Peak intensity 12.3 cd/lm
LEDs/each optic 1
Light colour/type White
Required components:

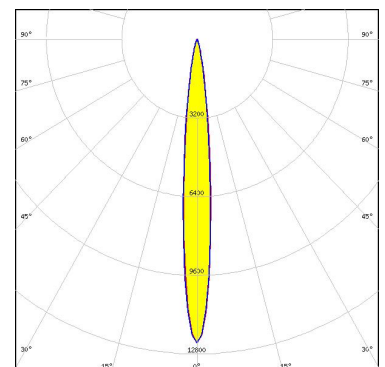

Light distribution files

GENERAL INFORMATION:

NOTE: The typical beam angle will be changed by different color, chip size and chip position tolerance. The typical total beam angle is the full angle measured where the luminous intensity is half of the peak value.

MATERIALS:

As part of our continuous research and improvement processes, and to ensure the best possible quality and availability of our products, LEDiL reserves the right to change material grades without notice.

PRODUCT DATA USER AGREEMENT AND DISCLAIMER:

The measured data in the provided downloadable LEDiL Product Datasheets and Mechanical 2D-Drawings is rounded and provided as reference for planning. LEDiL Oy's optical specifications have been verified by conducting performance testing of the products in accordance with the company's quality system. The reported data are averaged results of multiple measurements with typical variation. LEDiL Oy reserves the right to without prior notification make changes and improvements to its products.

LEDiL Oy assumes neither warranty, nor guarantee nor any other liability of any kind for the contents and correctness of the provided data. The provided data has been generated with highest diligence but the provided data may in reality not represent the complete possible variation range of all intrinsic parameters. Therefore, in certain cases a deviation from the provided data could occur.

LEDiL Oy reserves the right to undertake technical changes of its products without further notification which could lead to changes in the provided data. LEDiL Oy assumes no liability of any kind for the possible deviation from any provided data or any other damage resulting from the usage of the provided data.

The user agrees to this disclaimer and user agreement with the download or usage of the provided files.

LEDiL Oy

Joensuunkatu 13
FI-24240 SALO
Finland

LEDiL Inc.

228 West Page Street
Suite D
Sycamore IL 60178
USA

Ledil Optics Technology (Shenzhen) Co., Ltd.

405 , Block B
Casic Motor Building
Shenzhen 518057
P.R.CHINA

Local sales and technical support

[www.ledil.com/
where_to_buy](http://www.ledil.com/where_to_buy)

Shipping locations

Poznan, Poland
Hong Kong, China

Distribution Partners

[www.ledil.com/
where_to_buy](http://www.ledil.com/where_to_buy)