

THIS DOCUMENT IS THE PROPERTY OF
KEYSTONE ELECTRONICS CORP. AND
SHALL NOT BE REPRODUCED, DISTRIBUTED
OR USED AS A BASIS FOR MANUFACTURE
WITHOUT PRIOR WRITTEN PERMISSION
FROM KEYSTONE ELECTRONICS CORP.

ACTUAL SIZE

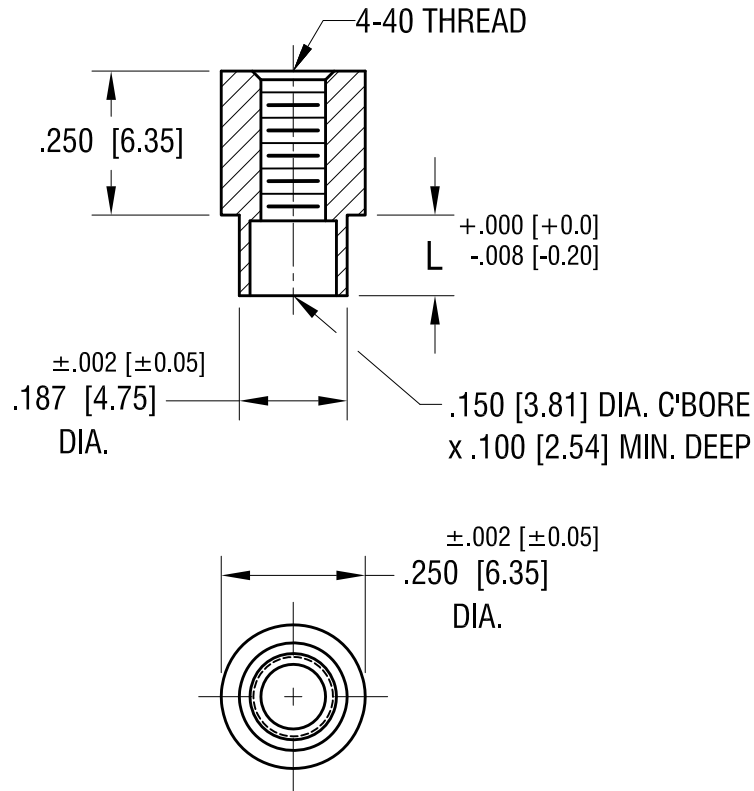

P/N 1650-2



PART NO.	'L' DIM.
1650-2	.109 [2.77]
1650-3	.140 [3.56]

KEYSTONE ELECTRONICS CORP.			
www.keyelco.com • NEW HYDE PARK NY 11040 • Tel (516)328-7500			
PART NAME			
SWAGE THREADED STANDOFF			
MATERIAL			
BRASS			
FINISH	DUCTILE NICKEL PLATE	DRN BY	BOONE
		DATE	5.13.02
		APP'D	LN
		SCALE	3X
TOLERANCES	INCH [MM]	CODE	DWG NO.
DECIMAL	± .005 [± 0.13]	C	1650-
ANGULAR	± 1°		
UNLESS OTHERWISE SPECIFIED			

11.22.21	CHANGE AS PER ECN 12-162	A
DATE	DESCRIPTION	REV.