

UL and CSA Recognized “ZNR” Transient/Surge Absorbers with Tabs

Type : **CK**

ZNR Transient/Surge Absorber with Tabs is a heavy duty type ZNR with very unique tab terminals which bring forth a higher reliability.

These tabs are used as electrical connecting terminals and also its mounting legs. This type of ZNR is meant for applications in power supplies or transient voltage surge suppressor units where large surge current or high surge energy absorption is required.

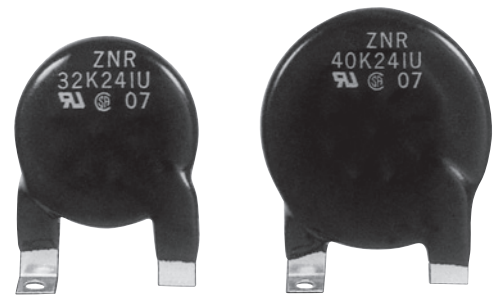

Features

- UL and CSA recognized components
- High energy handling capability (210 to 750 joules)
- Large withstanding peak current (25 to 30 kA, 8/20 μs, 1 time)
- Common terminals for electrical connection and mounting
- RoHS compliant

Recommended Applications

- Power suppliers for OA, FA, telecommunication or industrial equipment
- Power strips
- Transient voltage surge suppressor units

Note : Ask our factory for Product Specification before use.

■ As for Handling Precautions and Minimum Quantity / Packing Unit

Please see Related Information

Related Standards

Standard No.	UL1449	CSA C22.2 No.269.5
Title	Surge Protective Devices	Accessories and Parts for Electronic Products (Varistor for Across-The-Line use as transient protection on 120V ac nominal system)

- Each type designation is not registered by Part Number. Please contact us for further questions regarding type designation.

Explanation of Part Numbers

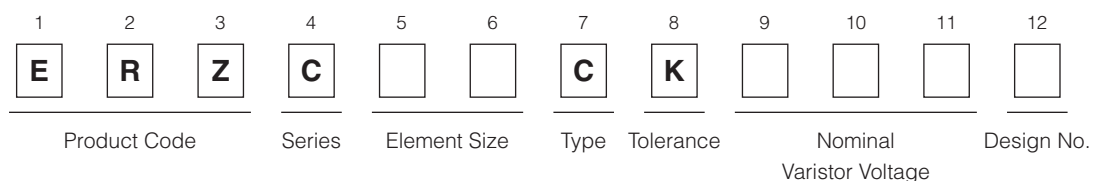

Panasonic “ZNR” Transient/Surge Absorbers (Type CK)

Ratings and Characteristics

- Operating Temperature Range : -40 to 85 °C
- Storage Temperature Range : -40 to 125 °C

Part No. (UL/CSA Recognized)	Type Designation	Varistor Voltage V_{1mA} (V)	Maximum Allowable Voltage		Maximum Clamping Voltage		Energy (2 ms, 1 time) (J)	Maximum Peak Current (8/20 μ s)	
			ACrms (V)	DC (V)	V_{XA} (V)	I_p (A)		1 time (kA)	2 times (kA)
ERZC32CK201W	32K201U	200 (185 to 225)	130	170	340	200	210	25	20
ERZC32CK241W	32K241U	240 (216 to 264)	150	200	395	200	240	25	20
ERZC32CK271W	32K271U	270 (247 to 303)	175	225	455	200	255	25	20
ERZC32CK361W	32K361U	360 (324 to 396)	230	300	595	200	325	25	20
ERZC32CK391W	32K391U	390 (351 to 429)	250	320	650	200	350	25	20
ERZC32CK431W	32K431U	430 (387 to 473)	275	350	710	200	400	25	20
ERZC32CK471W	32K471U	470 (423 to 517)	300	385	775	200	405	25	20
ERZC32CK511W	32K511U	510 (459 to 561)	320	415	845	200	405	25	20
ERZC32CK621W	32K621U	620 (558 to 682)	385	505	1025	200	415	25	20
ERZC32CK681W	32K681U	680 (612 to 748)	420	560	1120	200	450	25	20
ERZC32CK751W	32K751U	750 (645 to 825)	460	615	1240	200	500	25	20
ERZC32CK781W	32K781U	780 (702 to 858)	485	640	1290	200	520	25	20
ERZC32CK821W	32K821U	820 (738 to 902)	510	670	1355	200	545	25	20
ERZC32CK911W	32K911U	910 (819 to 1001)	550	745	1500	200	600	25	20
ERZC32CK951W	32K951U	950 (855 to 1045)	575	765	1570	200	600	25	20
ERZC40CK201W	40K201U	200 (185 to 225)	130	170	340	250	260	30	25
ERZC40CK241W	40K241U	240 (216 to 264)	150	200	395	250	300	30	25
ERZC40CK271W	40K271U	270 (247 to 303)	175	225	455	250	340	30	25
ERZC40CK361W	40K361U	360 (324 to 396)	230	300	595	250	405	30	25
ERZC40CK391W	40K391U	390 (351 to 429)	250	320	650	250	435	30	25
ERZC40CK431W	40K431U	430 (387 to 473)	275	350	710	250	500	30	25
ERZC40CK471W	40K471U	470 (423 to 517)	300	385	775	250	505	30	25
ERZC40CK511W	40K511U	510 (459 to 561)	320	415	845	250	505	30	25
ERZC40CK621W	40K621U	620 (558 to 682)	385	505	1025	250	515	30	25
ERZC40CK681W	40K681U	680 (612 to 748)	420	560	1120	250	560	30	25
ERZC40CK751W	40K751U	750 (645 to 825)	460	615	1240	250	625	30	25
ERZC40CK781W	40K781U	780 (702 to 858)	485	640	1290	250	650	30	25
ERZC40CK821W	40K821U	820 (738 to 902)	510	670	1355	250	680	30	25
ERZC40CK911W	40K911U	910 (819 to 1001)	550	745	1500	250	750	30	25
ERZC40CK951W	40K951U	950 (855 to 1045)	575	765	1570	250	750	30	25

Dimensions in mm (not to scale)

ZNR
Abbreviation of Part No.
Date code

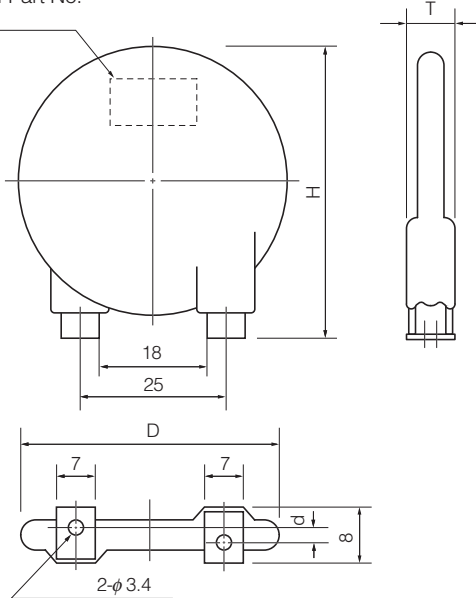

Part No. (UL/CSA Recognized)	Type Designation	D max.	H max.	T max.	d
ERZC32CK201W	32K201U	36	46	7.5	5.7±1.0
ERZC32CK241W	32K241U			7.5	5.4±1.0
ERZC32CK271W	32K271U			8.5	5.2±1.0
ERZC32CK361W	32K361U			9.0	4.6±1.0
ERZC32CK391W	32K391U			9.0	4.4±1.0
ERZC32CK431W	32K431U			9.0	4.1±1.0
ERZC32CK471W	32K471U			9.7	3.9±1.0
ERZC32CK511W	32K511U			9.7	4.5±1.0
ERZC32CK621W	32K621U			9.7	3.9±1.0
ERZC32CK681W	32K681U			9.7	3.6±1.0
ERZC32CK751W	32K751U			10.5	3.3±1.0
ERZC32CK781W	32K781U			10.5	3.1±1.0
ERZC32CK821W	32K821U			10.5	2.9±1.0
ERZC32CK911W	32K911U			11.5	2.5±1.0
ERZC32CK951W	32K951U			11.5	2.3±1.0
ERZC40CK201W	40K201U			44	55
ERZC40CK241W	40K241U	7.5	5.4±1.0		
ERZC40CK271W	40K271U	8.5	5.2±1.0		
ERZC40CK361W	40K361U	9.0	4.6±1.0		
ERZC40CK391W	40K391U	9.0	4.4±1.0		
ERZC40CK431W	40K431U	9.0	4.1±1.0		
ERZC40CK471W	40K471U	9.7	3.9±1.0		
ERZC40CK511W	40K511U	9.7	4.5±1.0		
ERZC40CK621W	40K621U	9.7	3.9±1.0		
ERZC40CK681W	40K681U	9.7	3.6±1.0		
ERZC40CK751W	40K751U	10.5	3.3±1.0		
ERZC40CK781W	40K781U	10.5	3.1±1.0		
ERZC40CK821W	40K821U	10.5	2.9±1.0		
ERZC40CK911W	40K911U	11.5	2.5±1.0		
ERZC40CK951W	40K951U	11.5	2.3±1.0		

Typical Characteristics

Voltage vs. Current (ERZC32CK201W to ERZC32CK951W)

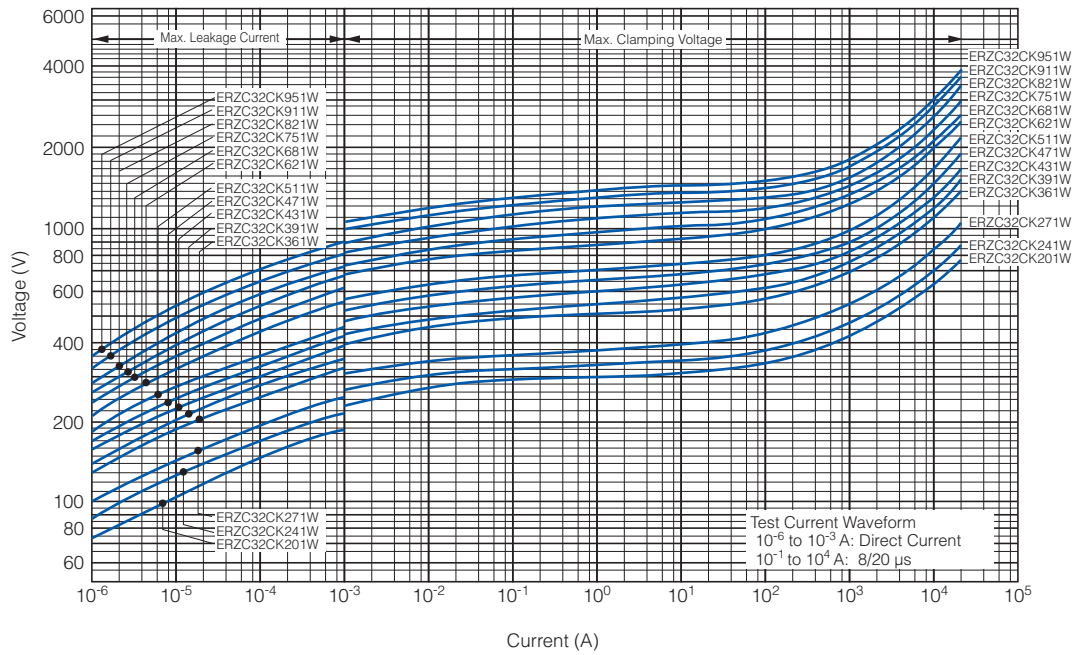

(ERZC40CK201W to ERZC40CK951W)

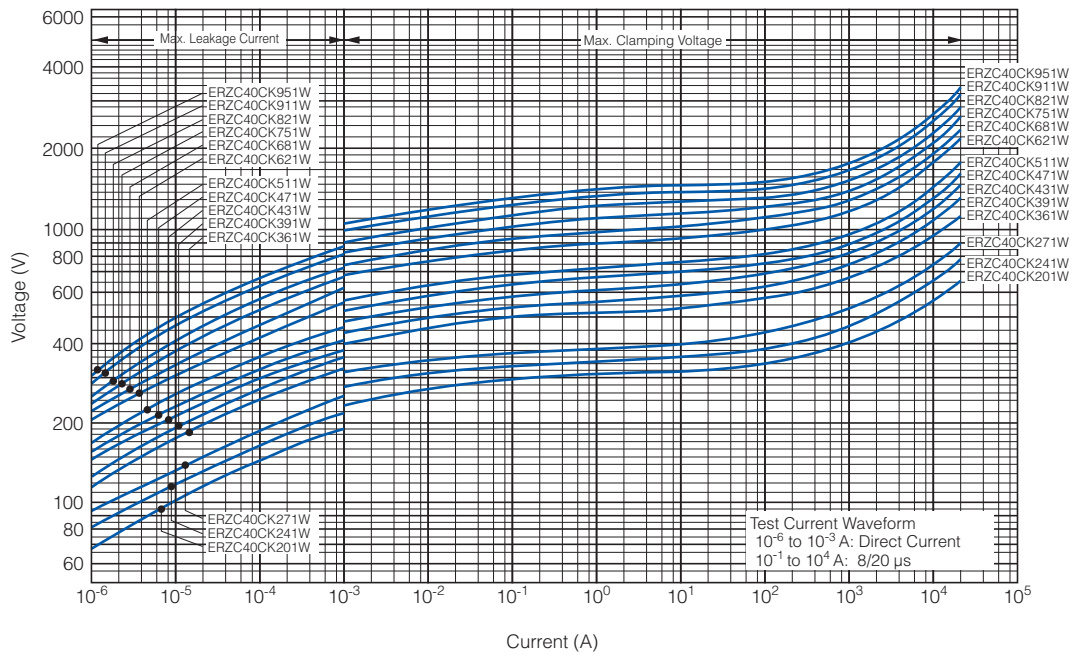

UL, CSA Recognized Components and The A.C. Rated Voltage

Part No. (UL/CSA Recognized)	Maximum Allowable Voltage		Rated Voltage (Vrms)	
	ACrms (V)	DC (V)	UL1449	CSA C22.2 No.269.5
ERZC32CK201W	130	170	118	118
ERZC32CK241W	150	200	136	136
ERZC32CK271W	175	225	159	159
ERZC32CK361W	230	300	209	209
ERZC32CK391W	250	320	227	227
ERZC32CK431W	275	350	250	250
ERZC32CK471W	300	385	272	272
ERZC32CK511W	320	415	291	291
ERZC32CK621W	385	505	350	350
ERZC32CK681W	420	560	381	381
ERZC32CK751W	460	615	418	418
ERZC32CK781W	485	640	440	440
ERZC32CK821W	510	670	463	463
ERZC32CK911W	550	745	500	500
ERZC32CK951W	575	765	522	522
ERZC40CK201W	130	170	118	118
ERZC40CK241W	150	200	136	136
ERZC40CK271W	175	225	159	159
ERZC40CK361W	230	300	209	209
ERZC40CK391W	250	320	227	227
ERZC40CK431W	275	350	250	250
ERZC40CK471W	300	385	272	272
ERZC40CK511W	320	415	291	291
ERZC40CK621W	385	505	350	350
ERZC40CK681W	420	560	381	381
ERZC40CK751W	460	615	418	418
ERZC40CK781W	485	640	440	440
ERZC40CK821W	510	670	463	463
ERZC40CK911W	550	745	500	500
ERZC40CK951W	575	765	522	522

Panasonic “ZNR” Transient/Surge Absorbers (Type CK)

Performance Characteristics (Type CK)

Characteristics		Test Methods/Description	Specifications															
Standard Test Condition		Electrical characteristics shall be measured at following conditions (Temperature: 5 to 35 °C, Humidity: Max. 85 %).	—															
Electrical	Varistor Voltage	The voltage between two terminals with the specified measuring current 1mA DC applied is called V_i or V_{1mA} . The measurement shall be made as fast as possible to avoid heat affection.	To meet the specified value.															
	Maximum Allowable Voltage	The maximum sinusoidal wave voltage (rms) or the maximum DC voltage that can be applied continuously.																
	Clamping Voltage	The maximum voltage between two terminals with the specified standard impulse current (8/20 μ s).																
	Rated Power	The maximum power that can be applied within the specified ambient temperature.																
	Energy	The maximum energy within the varistor voltage change of ± 10 % when one impulse of 2 ms is applied.																
	Maximum Peak Current	2 times		The maximum current within the varistor voltage change of ± 10 % with the standard impulse current (8/20 μ s) applied two times with an interval of 5 minutes.														
1 time		The maximum current within the varistor voltage change of ± 10 % with the standard impulse current (8/20 μ s) applied one time.																
Mechanical	Robustness of Terminations (Tensile)	After gradually applying the force of 19.6 N (2 kgf) and keeping the unit fixed for ten seconds, the terminal shall be visually examined for any damage.	No remarkable damage															
	Vibration	After repeatedly applying a single harmonic vibration (amplitude: 0.35 mm): double amplitude: 0.7mm with 1 minute vibration frequency cycles (10 Hz to 55 Hz to 10 Hz) to each of three perpendicular directions for 2 hours. Thereafter, the unit shall be visually examined.	No remarkable damage															
	Solderability	After dipping the terminal to a depth of approximately 3 mm from the body in a soldering bath of 230 ± 5 °C for 5.0 ± 0.5 seconds, the terminal shall be visually examined.	Approximately 95 % of the terminals shall be covered with new solder uniformly.															
	Resistance to Soldering Heat	The terminal shall be dipped into a soldering bath having a temperature of 350 ± 10 °C to a point 4.0 ± 0.8 mm from the body of the unit and then be held there for 3.0 ± 0.5 seconds. The change of V_c and mechanical damage shall be examined.	$\Delta V_{1mA}/V_{1mA} \leq \pm 5$ % No remarkable damage															
Environmental	Dry Heat/ High Temperature Storage	The specimen shall be subjected to 125 ± 2 °C for 500 hours in a thermostatic bath without load and then stored at room temperature and humidity for one to two hours. Thereafter, the change of V_c shall be measured.	$\Delta V_{1mA}/V_{1mA} \leq \pm 5$ %															
	Damp Heat/ Humidity (Steady State)	The specimen shall be subjected to 40 ± 2 °C, 90 to 95 %RH for 1000 hours without load and then stored at room temperature and humidity for one to two hours. Thereafter, the change of V_c shall be measured.																
	Temperature Cycle	The temperature cycle shown below shall be repeated five times and then stored at room temperature and humidity for one to two hours. The change of V_c and mechanical damage shall be examined. <table border="1" data-bbox="587 1780 1043 1926"> <thead> <tr> <th>Step</th> <th>Temperature (°C)</th> <th>Period (minutes)</th> </tr> </thead> <tbody> <tr> <td>1</td> <td>-25 ± 3</td> <td>30^{+3}_0</td> </tr> <tr> <td>2</td> <td>Room Temp.</td> <td>3 max.</td> </tr> <tr> <td>3</td> <td>85 ± 2</td> <td>30^{+3}_0</td> </tr> <tr> <td>4</td> <td>Room Temp.</td> <td>3 max.</td> </tr> </tbody> </table>	Step	Temperature (°C)	Period (minutes)	1	-25 ± 3	30^{+3}_0	2	Room Temp.	3 max.	3	85 ± 2	30^{+3}_0	4	Room Temp.	3 max.	$\Delta V_{1mA}/V_{1mA} \leq \pm 5$ % No remarkable damage
	Step	Temperature (°C)	Period (minutes)															
1	-25 ± 3	30^{+3}_0																
2	Room Temp.	3 max.																
3	85 ± 2	30^{+3}_0																
4	Room Temp.	3 max.																
Dry Heat Load/ High Temperature Load	After being continuously applied the Maximum Allowable Voltage at 85 ± 2 °C for 500 hours, the specimen shall be stored at room temperature and humidity for one to two hours. Thereafter, the change of V_c shall be measured.	$\Delta V_{1mA}/V_{1mA} \leq \pm 10$ %																

Guidelines and precautions regarding the technical information and use of our products described in this online catalog.

- If you want to use our products described in this online catalog for applications requiring special qualities or reliability, or for applications where the failure or malfunction of the products may directly jeopardize human life or potentially cause personal injury (e.g. aircraft and aerospace equipment, traffic and transportation equipment, combustion equipment, medical equipment, accident prevention, anti-crime equipment, and/or safety equipment), it is necessary to verify whether the specifications of our products fit to such applications. Please ensure that you will ask and check with our inquiry desk as to whether the specifications of our products fit to such applications use before you use our products.
- The quality and performance of our products as described in this online catalog only apply to our products when used in isolation. Therefore, please ensure you evaluate and verify our products under the specific circumstances in which our products are assembled in your own products and in which our products will actually be used.
- If you use our products in equipment that requires a high degree of reliability, regardless of the application, it is recommended that you set up protection circuits and redundancy circuits in order to ensure safety of your equipment.
- The products and product specifications described in this online catalog are subject to change for improvement without prior notice. Therefore, please be sure to request and confirm the latest product specifications which explain the specifications of our products in detail, before you finalize the design of your applications, purchase, or use our products.
- The technical information in this online catalog provides examples of our products' typical operations and application circuits. We do not guarantee the non-infringement of third party's intellectual property rights and we do not grant any license, right, or interest in our intellectual property.
- If any of our products, product specifications and/or technical information in this online catalog is to be exported or provided to non-residents, the laws and regulations of the exporting country, especially with regard to security and export control, shall be observed.

<Regarding the Certificate of Compliance with the EU RoHS Directive/REACH Regulations>

- The switchover date for compliance with the RoHS Directive/REACH Regulations varies depending on the part number or series of our products.
- When you use the inventory of our products for which it is unclear whether those products are compliant with the RoHS Directive/REACH Regulation, please select "Sales Inquiry" in the website inquiry form and contact us.

We do not take any responsibility for the use of our products outside the scope of the specifications, descriptions, guidelines and precautions described in this online catalog.

"ZNR" Transient/Surge Absorbers, Type E
 "ZNR" Transient/Surge Absorbers, Type CK, SC

Handling Precautions

Safety Precautions

In case that a ZNR Surge Absorber (hereafter referred to as the ZNR, or product name) is used, if an abnormality takes place because of peripheral conditions of the ZNR(material, environments, power source conditions, circuit conditions, etc. in equipment design), fire, electric shock, burn, or product failure may be occur. The precautions for this product are described below, understand the content thoroughly before usage. For more questions, contact us.

If there's any uncertainty/doubt/products safety items, please contact us. When a dogma shall be occurred about safety for this products, be sure to inform us rapidly, operate your technical examination.

1. Operating Conditions precautions to be strictly observed

1.1 Confirmation of performance ratings

Use the ZNR within its rated range of performance such as the Max. allowable voltage, withstanding surge current, withstanding energy, impulse life(surge life), average pulse power, and operating temperature range. If used outside the range, the ZNR can be degrade and have element fracture, which may result in smoking and ignition.

1.2 To avoid accidents due to unexpected phenomena, take the following measures

1) Across-the-line use

When the ZNR is used across a line, put a current fuse in series with the ZNR (Refer to Table 1).

2) Use between line to ground

(1) If the case that the ZNR is used between a line to the ground, the short-circuit of the ZNR may not blow the current fuse because of grounding resistance, which may cause smoking and ignition of the ZNR's exterior resin.

As the measure against it, install an earth leakage breaker on the power supply side of the ZNR position. If no earth leakage breaker is installed, use a thermal fuse together with a current fuse in series. (Refer to Table 1.)

(2) If the case that the ZNR is used between a live part to metal case, an electric shock may develop at a shortcircuit of the ZNR ; hence, ground the metal case to the ground or keep it from the human body.

3) In the event of fracture of the ZNR, its pieces may scatter ; hence, put the case or cover of the set product in place.

4) Do not install the ZNR near combustible substances(polyvinyl chloride wires, resin moldings, etc.).

If it is difficult to do, install a nonflammable cover.

1.3 The live part shall be equipped with a protective cover for preventing electric shock.

1.4 If ZNR is shorted out and happen smoke or ignition, please cut provided current to ZNR immediately.

● Recommendation fuse

Series	ERZC20EK□□□	ERZC32□K□□□	ERZVS34C□□□	ERZC40CK□□□
Current Fuse (Line - Line)	10 A max.	20 A max.	20 A max.	20 A max.
Thermal. Fuse (Line - Ground)	100 to 120 °C 5 A	100 to 120 °C 10 A	100 to 120 °C 10 A	100 to 120 °C 10 A

◆ Fuses shall use rated voltages appropriate for circuits.

◆ Finally, confirm that the secondary disaster does not occur even if the ZNR mounted on equipment breaks.

◆ Set a thermal fuse to get high thermal conductivity with ZNR.

2. Application notes

2.1 Pay attention to the following items to avoid the shortened life and failure of the ZNR

1) Circuit conditions

(1) Select a ZNR of which the maximum voltage including fluctuations in source voltage allows for the maximum permissible circuit voltage.

- (2) In cases that surges are intermittently applied at short intervals (for example, in the case that the voltage of the noise simulator test is impressed), do not cause them to exceed the ZNR's rated pulse power.
- (3) Select a ZNR recommended in Table 1.
 - ① Across-the-Line Use

Because the primary line voltage temporarily rises due to load unbalance of separately wired loads, short circuit between the live line and the neutral line or LC resonance at switching for a capacitate load, ZNR with * are recommended for AC100V or AC120V applications.
 - ② Line to ground Use
 - When DC500V insulation resistance test of the circuits employing ZNR is conducted, the ZNR shall be removed after getting approval from the customer, or the ZNR ** with the Maximum Allowable voltage exceeding to the test voltage shall be applied.
 - When AC1000V dielectric with standing test is conducted, ZNR shall be removed after getting approval from the customer according to the relevant regulations, or the ZNR *** with the Maximum Allowable voltage exceeding to the test voltage shall be applied.
- 2) Operating environments
 - (1) The ZNR is designed and manufactured for application in general purpose electronic devices. The ZNR shall not be exposed to the weather, except for usage inside unit.
 - (2) Do not use the ZNR in places exposed to temperatures beyond the operating temperature range, such as places exposed to sunlight and vicinities of heating equipment.
 - (3) Do not use the ZNR in places exposed to high temperatures and high humidity, such as places exposed directly to rain, wind, dew condensation, and vapor.
 - (4) Do not use the ZNR in dusty and salinity environment and atmospheres polluted by corrosive gases, in liquids such as water, oil, chemical, organic solvent.
- 3) Processing conditions
 - (1) Do not wash the ZNR by such solvents(thinner, acetone, etc.) as its exterior resin deteriorates.
 - (2) Do not apply a strong vibration or shock (by falling, etc.) to the ZNR, cracking to its exterior resin and element may occur.
 - (3) When coating the ZNR with resin(including molding), do not use such resin.
 - (4) Do not bend the ZNR lead wires at the position close to its ZNR exterior resin, or apply external force to the position.
 - (5) When soldering the ZNR lead wires, follow the recommended condition and do not melt the solder and insulating materials constituting the ZNR.
 - (6) Keep the wiring of the ZNR as short and straight as possible.
- 4) Long-term storage
 - (1) Do not store the ZNR under high temperature and high humidity. Store it indoor environment at a temperature up to 40 °C and at humidity below 75 %RH, and use it within two years. Before using the ZNR that has been stored for a long period(two years or longer), confirm the solderability.
 - (2) Avoid atmospheres full of corrosive gases (hydrogen sulfide, sulfurous acid, chlorine, ammonia, etc.).
 - (3) Avoid direct sunlight and dew condensation.

2.2 The recommended fuse position is shown in Table.1, "Example of ZNR application", however, if the load current of protected equipment is larger than that of the above recommended fuse rated current, install a current fuse at the position shown below.

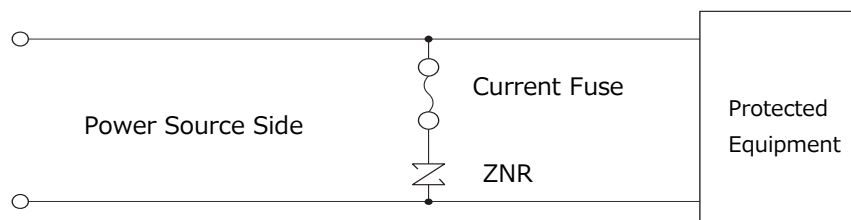

3. Notices

- 3.1 In cases that the ZNR is used in equipment (aerospace equipment, medical equipment, etc.) requiring extremely high reliability, ask us for selection of part No., and protection coordination, etc. in advance.
- 3.2 There is possibility that the ZNR will unexpectedly smoke or ignite because of abnormal rise of the circuit voltage and invasion of excessive surge. To prevent that accident from spreading over the equipment and not to expand the damage, use multiplex protection such as the adoption of frame-retardant materials for housing parts and structural parts.
- 3.3. We don't bear any responsibility for product malfunction or abnormal conditions which caused by using beyond the descriptions in this product specification.
- 3.4 Package marking includes the product number, quantity, and country of origin. As a rule, country of origin should be indicated in English.

4. Applicable laws and regulations , others

- 4.1 This product not been manufactured with any ozone depleting chemical controlled under the Montreal Protocol.
- 4.1 Specified brominated flame retardants (including PBB (polybromobiphenyl) and PBDE (polybromodiphenyl ether)) are not intentionally used in the components of this product.
- 4.3 This product comply with RoHS(Restriction of the use of certain Hazardous Substance in electrical and electronic equipment) (DIRECTIVE 2011/65/EU and 2015/863/EU).
- 4.4 All the materials used in this part are registered material under the Law Concerning the Examination and Regulation of Manufacture, etc. of Chemical Substance.
- 4.5 If you need the notice by letter of "A preliminary judgement on the Laws of Japan foreign exchange and Foreign Trade Control", be sure to let us know.
- 4.6 These products are not dangerous goods on the transportation as identified by UN(United nations) numbers or UN classification.

5. Others

- 5.1 As to the disposal of ZNR, check the method of disposal in each country or origin where the ZNR are incorporated in your products to be used.
- 5.2 The technical information in this specification provides example of our products' typical operations and application circuit. We do not guarantee the non-infringement of third party's intellectual property rights and we do not grant any license, right or interest in our intellectual property.

Table 1 Example of ZNR application

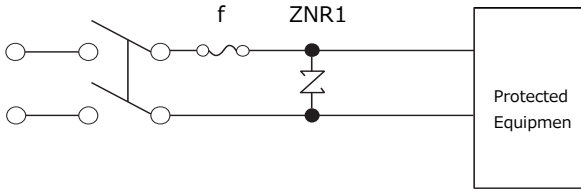
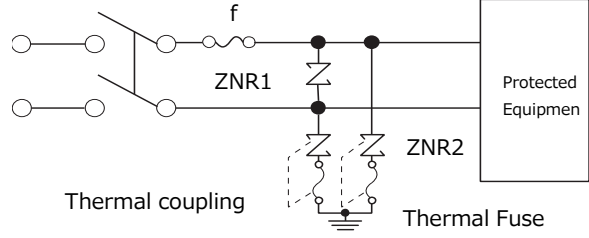
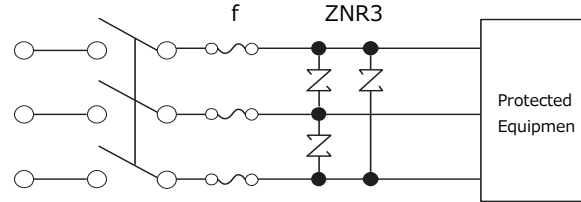
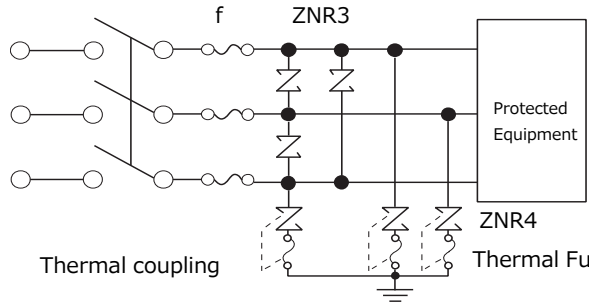
	Across-the-Line/Line to Line Protection			Line to Line and Line to Ground Protection			
	Connections example	DC/AC Single-phase			DC/AC Single-phase		
							
f : fuse			f : fuse				
AC 3-phase			AC 3-phase				
							
f : fuse			f : fuse				
Selection Examples	Across the Line Use/Line to Line			Line to Ground Use			
	ZNR	Nominal Line Voltage	Part Number of ZNR Type E, CK, SC	ZNR	Nominal Line Voltage	Part Number of ZNR Type E, CK, SC	
	ZNR 1 ZNR 3	AC 100 V	ERZC□□EK ERZC□□CK ERZVS34C	201 241 271	ZNR 2 ZNR 4	AC 100 V ~ AC 220 V	471 511 821 and more **
		AC 120 V		241 271*			
	AC 200 V ~ AC 220 V		471		AC 240 V	511 821 and more **	
	AC 240 V		511				

Mouser Electronics

Authorized Distributor

Click to View Pricing, Inventory, Delivery & Lifecycle Information:

Panasonic:

[ERZ-C32CK201B](#) [ERZ-C32CK271W](#) [ERZ-C32CK431B](#) [ERZ-C32CK621W](#) [ERZ-C32CK681B](#) [ERZ-C32CK821B](#)
[ERZ-C40CK241B](#) [ERZ-C40CK361B](#) [ERZ-C40CK391B](#) [ERZ-C40CK431B](#) [ERZ-C40CK621B](#) [ERZ-C40CK681B](#) [ERZ-](#)
[C40CK821B](#) [ERZ-C32CK201W](#) [ERZ-C32CK681W](#) [ERZ-C32CK821W](#) [ERZ-C40CK751W](#) [ERZ-C32CK241W](#) [ERZ-](#)
[C40CK621W](#) [ERZ-C32CK621B](#) [ERZ-C40CK911W](#) [ERZ-C40CK681W](#) [ERZ-C32CK781W](#) [ERZ-C40CK241W](#) [ERZ-](#)
[C32CK391W](#) [ERZ-C40CK201W](#) [ERZ-C32CK431W](#) [ERZ-C32CK471W](#) [ERZ-C32CK751W](#) [ERZ-C40CK511W](#) [ERZ-](#)
[C40CK821W](#) [ERZ-C40CK271W](#) [ERZ-C40CK951W](#) [ERZ-C32CK951W](#) [ERZ-C32CK361W](#) [ERZ-C40CK431W](#) [ERZ-](#)
[C40CK361W](#) [ERZ-C40CK781W](#) [ERZ-C40CK391W](#) [ERZ-C32CK911W](#) [ERZ-C40CK471W](#) [ERZ-C32CK511W](#)