

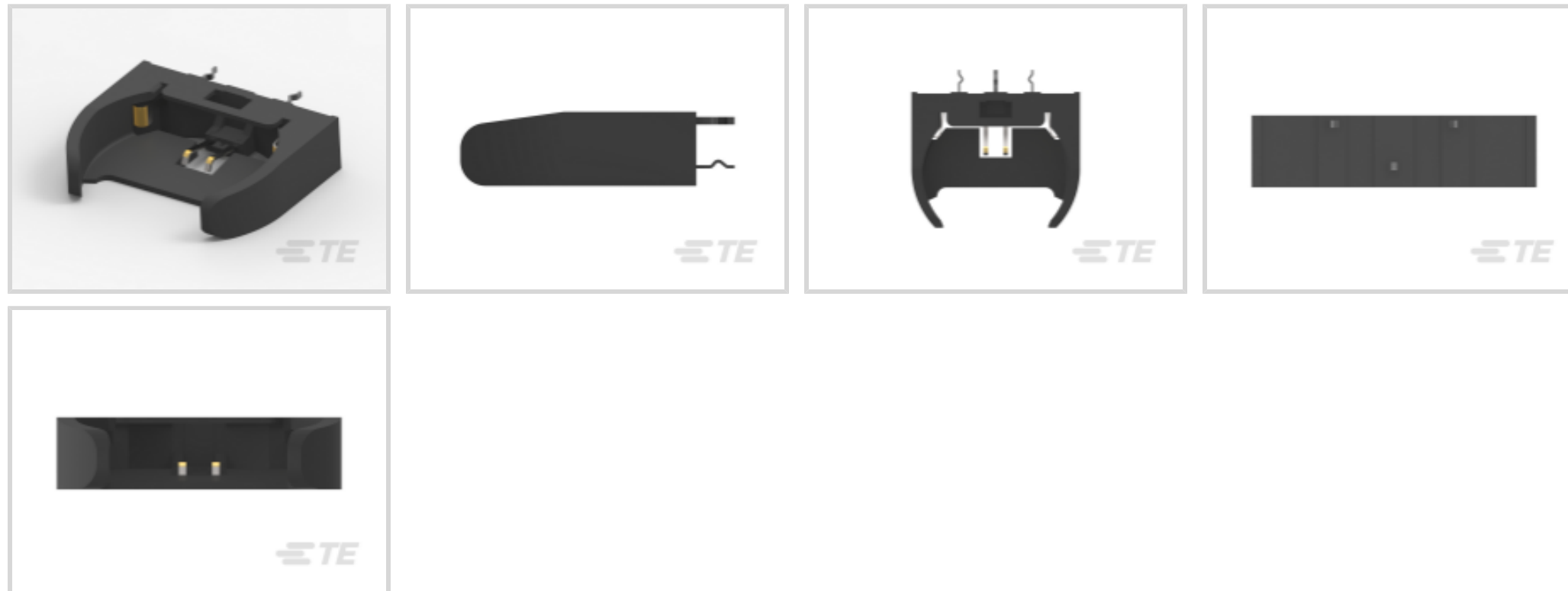

Connectors > PCB Connectors > Battery Connectors & Holders > Battery Holders



Battery Compatibility: **CR2032**
 Number of Positions: **2**
 PCB Mount Orientation: **Vertical**
 Contact Mating Area Plating Material: **Gold**
 PCB Mount Alignment: **Without**

Features

Product Type Features

Connector System	Board-to-Board
Connector & Contact Terminates To	Printed Circuit Board

Configuration Features

Number of Positions	2
PCB Mount Orientation	Vertical

Body Features

Battery Holder Material	Glass Filled Nylon 66
Battery Holder Type	Coin Cell
Primary Product Color	Black
Battery Compatibility	CR2032

Contact Features

Contact Underplating Material	Nickel
Contact Mating Area Plating Material	Gold
Contact Current Rating (Max)	7 A

Mechanical Attachment



Connector Mounting Type	Board Mount
-------------------------	-------------

PCB Mount Alignment	Without
---------------------	---------

Dimensions

Compatible Battery Dimensions	23 x 18.49 x 21 mm [.906 x .728 x .827 in]
-------------------------------	--------------------------------------------

Usage Conditions

Operating Temperature Range	-55 – 105 °C [-67 – 221 °F]
-----------------------------	-----------------------------

Operation/Application

Circuit Application	Signal
---------------------	--------

Packaging Features

Packaging Quantity	80
--------------------	----

Packaging Method	Box & Tray
------------------	------------

Product Compliance

[For compliance documentation, visit the product page on TE.com>](#)

EU RoHS Directive 2011/65/EU	Compliant
------------------------------	-----------

EU ELV Directive 2000/53/EC	Compliant
-----------------------------	-----------

China RoHS 2 Directive MIIT Order No 32, 2016	No Restricted Materials Above Threshold
-----------------------------------------------	-----------------------------------------

EU REACH Regulation (EC) No. 1907/2006	Current ECHA Candidate List: JUNE 2024 (241) Candidate List Declared Against: JAN 2024 (240) Does not contain REACH SVHC
----------------------------------------	--------------------------------------------------------------------------------------------------------------------------------

Halogen Content	Not Low Halogen - contains Br or Cl > 900 ppm.
-----------------	------------------------------------------------

Solder Process Capability	Wave solder capable to 265°C
---------------------------	------------------------------

Product Compliance Disclaimer

This information is provided based on reasonable inquiry of our suppliers and represents our current actual knowledge based on the information they provided. This information is subject to change. The part numbers that TE has identified as EU RoHS compliant have a maximum concentration of 0.1% by weight in homogenous materials for lead, hexavalent chromium, mercury, PBB, PBDE, DBP, BBP, DEHP, DIBP, and 0.01% for cadmium, or qualify for an exemption to these limits as defined in the Annexes of Directive 2011/65/EU (RoHS2). Finished electrical and electronic equipment products will be CE marked as required by Directive 2011/65/EU. Components may not be CE marked. Additionally, the part numbers that TE has identified as EU ELV compliant have a maximum concentration of 0.1% by weight in homogenous materials for lead, hexavalent chromium, and mercury, and 0.01% for cadmium, or qualify for an exemption to these limits as defined in the Annexes of Directive 2000/53/EC (ELV). Regarding the REACH Regulation, the information TE provides on SVHC in articles for this part number is based on the latest European Chemicals Agency (ECHA) 'Guidance on requirements for substances in articles' posted at this URL: <https://echa.europa.eu/guidance-documents/guidance-on-reach>

Compatible Parts



TE Part # 2-1775485-1
Battery Holder, 3.6mm, BLK, low profile



TE Part # 1775485-3
BATTERY HOLDER, 3.6MM, HIGH STANDOFF



TE Part # 6339488-1
VERTICAL BATTERY CONNECTOR ASSY



TE Part # 1-1775485-1
Battery Holder, 3.2mm, BLK, low profile



TE Part # 1775485-4
Battery Holder, 3.6mm, BLK, low profile



TE Part # 2-1775485-2
Battery Holder, 3.6mm, BLU, low profile

Customers Also Bought



TE Part #5084618-2
0.8FH,R13H.5,060,30/Sn,TR,SC



TE Part #5-146252-7
14 MODII HDR DRST B/A .100 LF

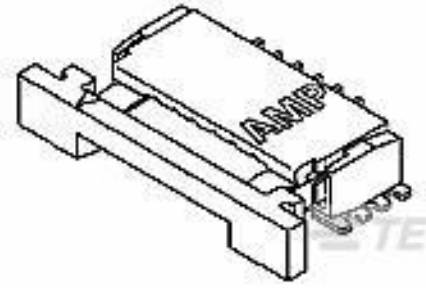

TE Part #2-84952-5
1MM FPC HORZ.BOTTOM CONT. ASSY 25P



TE Part #5-2337939-8
PCIE GEN4 CON,SMT,164POS,30u", MYLAR,HT

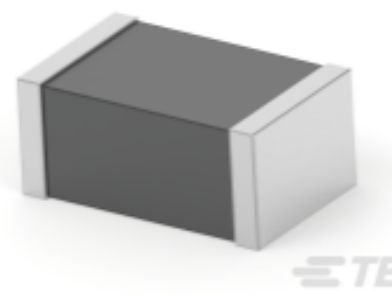

TE Part #2176487-2
BMC 0805 60R 25% A Med C



TE Part #1-2176611-3
EP 2W (SS) 3R3 5%



TE Part #2383435-1
HD CE VERTICAL PF :2X3HP-2X2LP-2X12S



TE Part #2-2199155-1
DDR4 DIMM 288 Pin SMT type

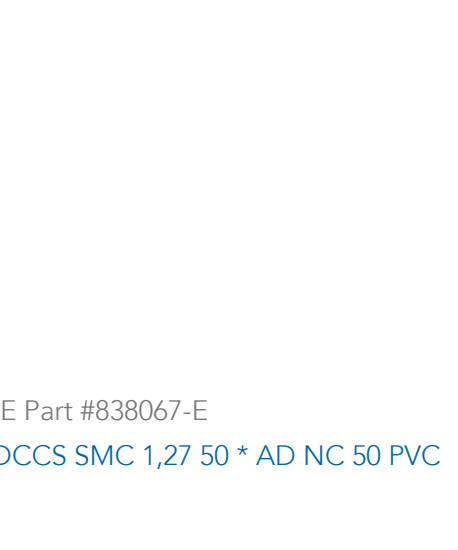

TE Part #838067-E
IDCCS SMC 1,27 50 * AD NC 50 PVC



Documents

Product Drawings

[Battery Holder, 3.6mm, BLK,low profile](#)

English

CAD Files

[3D PDF](#)

3D

Customer View Model

[ENG_CVM_CVM_1775485-1_A.2d_dxf.zip](#)

English

Customer View Model

[ENG_CVM_CVM_1775485-1_A.3d_igs.zip](#)

English

Customer View Model

[ENG_CVM_CVM_1775485-1_A.3d_stp.zip](#)

English

By downloading the CAD file I accept and agree to the [Terms and Conditions](#) of use.

Datasheets & Catalog Pages

[POWER_CONNECTORS_CATALOG_SEC09_LAPTOPS_PORTABLES](#)

English

[2_PIECE_POWER_CONNECTORS_qrg_4-1773458-1](#)

English

Product Specifications

[Application Specification](#)

English