

TINA-RS

~13° spot beam optimized for CREE XP-E.
Assembly with holder and installation tape.

SPECIFICATION:

Dimensions	Ø 16.1 mm
Height	9.7 mm
Fastening	tape
ROHS compliant	yes ⓘ



MATERIALS:

Component	Type	Material	Colour	Finish	Length (mm)
TINA-XP-RS	Single lens	PMMA	clear		
TINA-XP-H-TAPE-WHT	Holder	PC	white		
TINA-TAPE3	Tape	Acrylic foam	black		

ORDERING INFORMATION:

Component	Qty in box	MOQ	MPQ	Box weight (kg)
FA10887_TINA-RS » Box size: 470 x 240 x 105 mm	2016	288	144	4.0

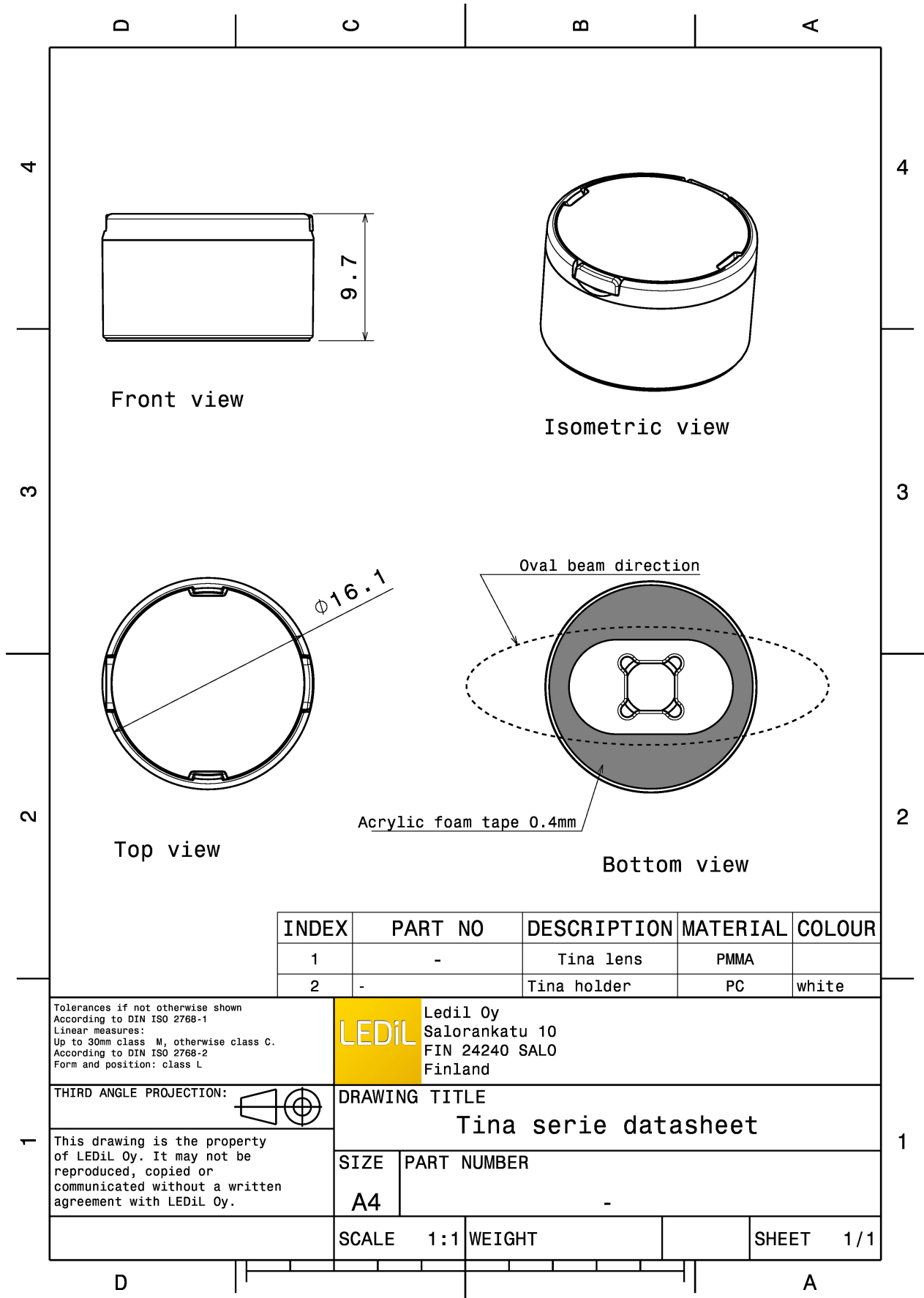

See also our general installation guide: www.ledil.com/installation_guide

OPTICAL RESULTS (MEASURED):



LED XP-E
FWHM / FWTM 10.0° / 19.0°
Efficiency 93 %
Peak intensity 18.3 cd/lm
LEDs/each optic 1
Light colour/type White
Required components:

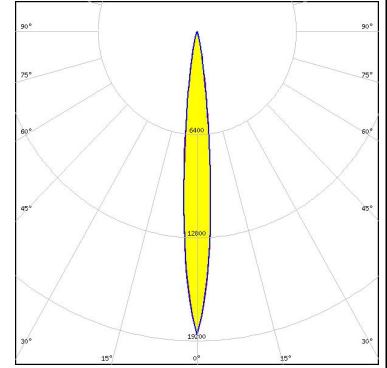

Light distribution files



LED XP-G
FWHM / FWTM 15.0° / 31.0°
Efficiency 94 %
Peak intensity 11.1 cd/lm
LEDs/each optic 1
Light colour/type White
Required components:

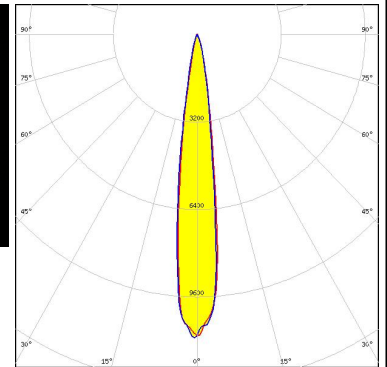

Light distribution files

OPTICAL RESULTS (SIMULATED):



LED XD16
FWHM / FWTM 12.0° / 24.0°
Efficiency 92 %
Peak intensity 13.2 cd/lm
LEDs/each optic 1
Light colour/type White
Required components:

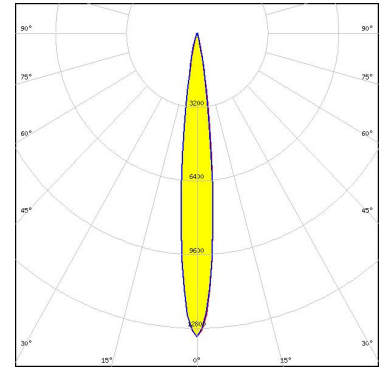

Light distribution files



LED LUXEON CZ
FWHM / FWTM 9.0° / 20.0°
Efficiency 94 %
Peak intensity 26.3 cd/lm
LEDs/each optic 1
Light colour/type Red
Required components:

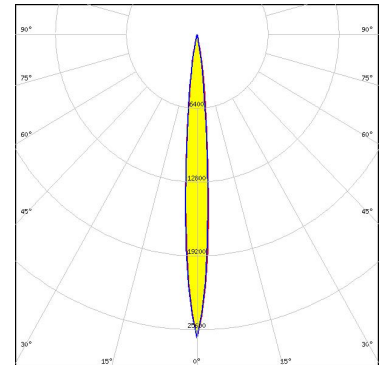

Light distribution files



LED NVSxx19B/NVSxx19C
FWHM / FWTM 18.0° / 32.0°
Efficiency 88 %
Peak intensity 7.4 cd/lm
LEDs/each optic 1
Light colour/type White
Required components:

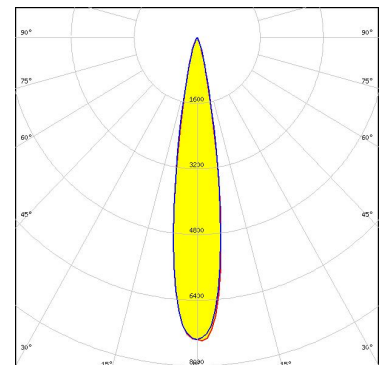

Light distribution files

OPTICAL RESULTS (SIMULATED):

OSRAM
Opto Semiconductors

LED OSLON Pure 1414
 FWHM / FWTM 24.0° / 43.0°
 Efficiency 95 %
 Peak intensity 4.1 cd/lm
 LEDs/each optic 4
 Light colour/type White
 Required components:

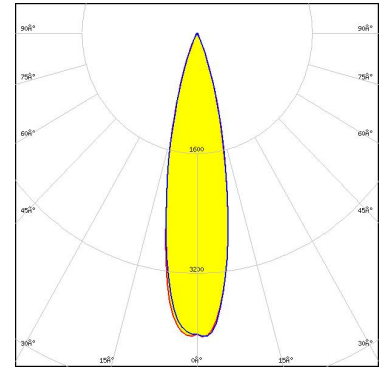

Light distribution files

OSRAM
Opto Semiconductors

LED OSLON Square CSSRM2/CSSRM3
 FWHM / FWTM 16.0° / 29.0°
 Efficiency 95 %
 Peak intensity 9.7 cd/lm
 LEDs/each optic 1
 Light colour/type White
 Required components:

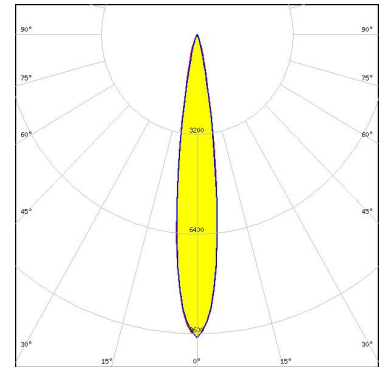

Light distribution files

SEMI
SEOUL SEMICONDUCTOR

LED Z5
 FWHM / FWTM 11.0°
 Efficiency %
 LEDs/each optic 1
 Light colour/type White
 Required components:

Light distribution files

OPTICAL RESULTS (SIMULATED):

 SEOL SEMICONDUCTOR	
LED	Z5M1/Z5M2
FWHM / FWTM	14.0° / 28.0°
Efficiency	94 %
Peak intensity	10.8 cd/m
LEDs/each optic	1
Light colour/type	White
Required components:	

Light distribution files

GENERAL INFORMATION:

NOTE: The typical beam angle will be changed by different color, chip size and chip position tolerance. The typical total beam angle is the full angle measured where the luminous intensity is half of the peak value.

MATERIALS:

As part of our continuous research and improvement processes, and to ensure the best possible quality and availability of our products, LEDiL reserves the right to change material grades without notice.

PRODUCT DATA USER AGREEMENT AND DISCLAIMER:

The measured data in the provided downloadable LEDiL Product Datasheets and Mechanical 2D-Drawings is rounded and provided as reference for planning. LEDiL Oy's optical specifications have been verified by conducting performance testing of the products in accordance with the company's quality system. The reported data are averaged results of multiple measurements with typical variation. LEDiL Oy reserves the right to without prior notification make changes and improvements to its products.

LEDiL Oy assumes neither warranty, nor guarantee nor any other liability of any kind for the contents and correctness of the provided data. The provided data has been generated with highest diligence but the provided data may in reality not represent the complete possible variation range of all intrinsic parameters. Therefore, in certain cases a deviation from the provided data could occur.

LEDiL Oy reserves the right to undertake technical changes of its products without further notification which could lead to changes in the provided data. LEDiL Oy assumes no liability of any kind for the possible deviation from any provided data or any other damage resulting from the usage of the provided data.

The user agrees to this disclaimer and user agreement with the download or usage of the provided files.

LEDiL Oy

Joensuunkatu 13
FI-24240 SALO
Finland

LEDiL Inc.

228 West Page Street
Suite D
Sycamore IL 60178
USA

Ledil Optics Technology (Shenzhen) Co., Ltd.

405 , Block B
Casic Motor Building
Shenzhen 518057
P.R.CHINA

Local sales and technical support

[www.ledil.com/
where_to_buy](http://www.ledil.com/where_to_buy)

Shipping locations

Poznan, Poland
Hong Kong, China

Distribution Partners

[www.ledil.com/
where_to_buy](http://www.ledil.com/where_to_buy)