



SIGN	DATE	DESCRIPTION	APPROVER
△	06/15'11	Add "cULus" Safety Approval logo	Aaron
△	06/15'11	The mark 5.08 is added	Aaron

*THIS IS CAD DRAWING, DO NOT REVISE MANUALLY!!!*

Material:

- Item a Terminal(Up housing): Thermoplastic (UL94V-0)
- Item b Terminal(Down housing): Thermoplastic (UL94V-0)
- Item c Terminal(Lever): Thermoplastic (UL94V-0)
- Item d Spring clamp: Stainless steel
- Item e Female contact: PhBz Tin Plated.
- Item f Terminal(Left latch): Thermoplastic (UL94V-0)
- Item g Terminal(Right latch): Thermoplastic (UL94V-0)

Electrical: cULus

- Voltage rating: 300 V
- Current rating: 12 A
- Wire range:
- Solid wire(AWG): 14-24
- Stranded wire(AWG): 14-24
- Wire strip length: 11-12 mm
- Withstanding Voltage: 1.6 KV
- Operating temperature: -40°C to +115°C
- Safety Approval: 
- Critical dimension: 

**KD xx 5 0 x 2 xxxx G**

- No. OF POLES
  - 02: 2 POLES
  - 03: 3 POLES
  - ...
  - 24: 24 POLES
- COLOR
  - 0 Black (RAL9005)
  - 2 Red (RAL3001/D)
  - 3 Orange(RAL2011/P)
  - 4 Yellow(RAL1018/A)
  - 5 Green(RAL6018/T)
  - 6 Blue (RAL5015/A)
  - 8 Grey(RAL7035/D)
  - 9 White(RAL1102)
  - C Green(RAL6018/U)
- G: Pb-40000ppm
- 0000: "@" Logo (Standard)
- 000A: "ANYTEK" Mark
- Any special item by customer request. please contact sales department.

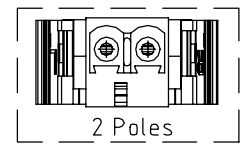
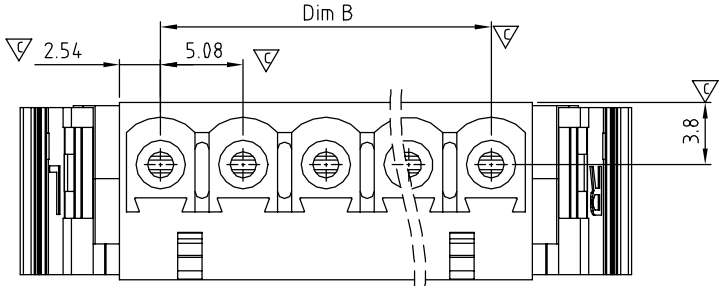
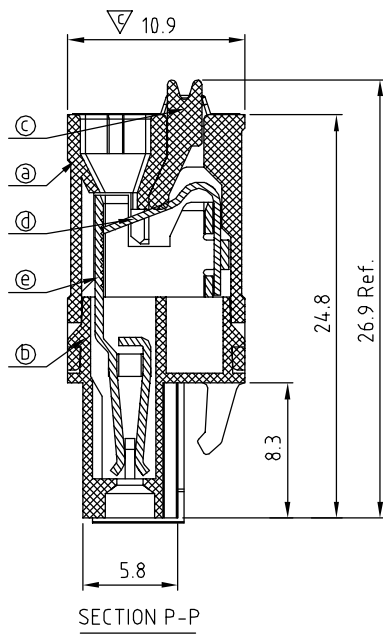
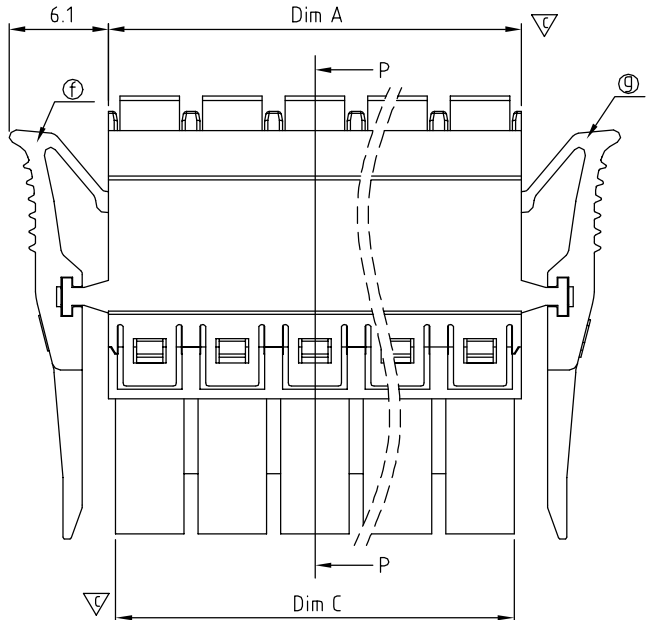
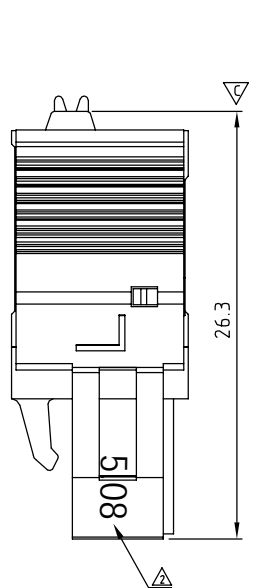
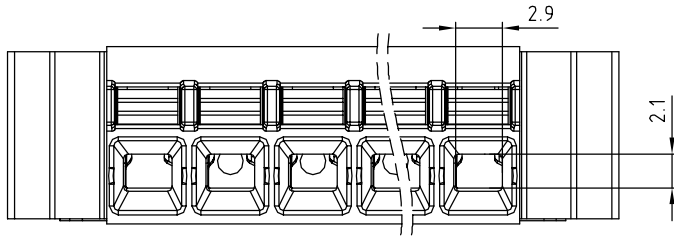

Dimension

DIM A	N×5.08
DIM B	(N-1)×5.08
DIM C	(N-1)×5.08+4.20

N=Number of poles

	TOL			
	2p-6p	7p-12p	13p-18p	19p-24p
Dim A	±0.15	±0.25	±0.35	±0.40
Dim B	±0.15	±0.25	±0.35	±0.40

<h1>ANYTEK</h1>		<h2>CUSTOMER COPY</h2>	
ALL RIGHTS RESERVED. REPRODUCTION OR ISSUE TO THIRD PARTIES IN ANY FORM WHATSOEVER IS NOT PERMITTED WITHOUT WRITTEN AUTHORITY FROM THE PROPRIETOR. PROPERTY OF ANYTEK TECHNOLOGY CO., LTD			
TITLE	KD 5.08mm With latch Series (2P-24P)		
PART NO.	KDxx50x2xxxxG	DWG NO.	8KD0202
APPROVED	CHECKED	DESIGNED	DRAWN
		Aaron 2011.06.15	Jacke 2009.08.26
SHEET: 01/01		Tolerance	
UNIT: mm		X. ±0.50	
SCALE: NONE		X.X ±0.30	
REV.: C		X.XX ±0.10	
		X° ±1°	

# Mouser Electronics

Authorized Distributor

Click to View Pricing, Inventory, Delivery & Lifecycle Information:

## Amphenol:

[KD0250520000G](#) [KD0350520000G](#) [KD0450520000G](#) [KD0550520000G](#) [KD0650520000G](#) [KD0750520000G](#)  
[KD0850520000G](#) [KD0950520000G](#) [KD1050520000G](#) [KD1150520000G](#) [KD1250520000G](#) [KD1350520000G](#)  
[KD1450520000G](#) [KD1550520000G](#) [KD1650520000G](#) [KD1750520000G](#) [KD1850520000G](#) [KD1950520000G](#)  
[KD2050520000G](#) [KD2150520000G](#) [KD2250520000G](#) [KD2350520000G](#) [KD2450520000G](#)