

*Enhanced Universal Platform  
System-on-Chip Processor*

# EDB9315A

Engineering Development Board

## *Technical Reference Manual*

---

## CORPORATE HEADQUARTERS

Cirrus Logic, Inc.  
2901 Via Fortuna  
Austin, Texas 78746  
United States  
Phone: (512) 851-4000  
Phone: (800) 888-5016

## INTERNATIONAL OFFICES

### ASIA PACIFIC

Cirrus Logic Intl. Ltd.  
20F, Ocean Building  
80 Shanghai Street  
Kowloon, Hong Kong  
China  
Phone: (852) 2376-0801  
Phone: (852) 2314-9920  
Fax: (852) 2375-1202

### JAPAN

Cirrus Logic K.K.  
Aioi Sonpo, Building 6F  
5-6 Niban-cho  
Chiyoda-ku  
Tokyo, 102-0084  
Japan  
Phone: +81 (3) 5226-7390  
Fax: +81 (3) 5226-7677

### EUROPE

Cirrus Logic (UK) Ltd.  
Park House, Mere Park, Dedmere Road  
Marlow, Bucks, SL7 1FJ, England  
Phone ++49 89 818 974 65  
Switchboard +44 1628 891300  
Fax +44 1628 891988

---

## Table of Contents

<b>CORPORATE HEADQUARTERS</b> .....	<b>2</b>
<b>INTERNATIONAL OFFICES</b> .....	<b>2</b>
ASIA PACIFIC .....	2
JAPAN .....	2
EUROPE .....	2
<b>1. EDB9315A Kit Contents</b> .....	<b>5</b>
<b>2. Introducing the EDB9315A Engineering Development Board</b> .....	<b>6</b>
2.1 Identifying What's on the Board .....	6
<b>3. Getting Started</b> .....	<b>8</b>
3.1 Before you Begin... ..	8
3.2 Attaching Cables .....	8
3.3 Before Applying Power... ..	8
<b>4. EDB9315A Circuit Description</b> .....	<b>10</b>
4.1 Circuit Operation .....	11
Circuit Description, Schematic Page 1 .....	11
Circuit Description, Schematic Page 2 .....	11
Circuit Description, Schematic Page 3 .....	11
Circuit Description, Schematic Page 4 .....	11
Circuit Description, Schematic Page 5 .....	12
Circuit Description, Schematic Page 6 .....	12
Circuit Description, Schematic Page 7 .....	12
Circuit Description, Schematic Page 8 .....	12
Circuit Description, Schematic Page 9 .....	13
Circuit Description, Schematic Page 10 .....	13
Circuit Description, Schematic Page 11 .....	13
Circuit Description, Schematic Page 12 .....	13
Circuit Description, Schematic Page 13 .....	13
Circuit Description, Schematic Page 14 .....	14
<b>5. Software</b> .....	<b>15</b>
5.1 Overview .....	15
5.2 Download Utility .....	15
<b>6. Developer's User Forum</b> .....	<b>16</b>
<b>7. Other Useful Information</b> .....	<b>17</b>
Web Sites .....	17
Processor Information .....	17
Application Notes .....	17
Board Information .....	17
Code Information .....	17
<b>Appendix A. Schematics</b> .....	<b>18</b>
<b>Appendix B. Programming Linux Images into Flash from a Windows® PC</b> .....	<b>33</b>
Materials and Equipment Needed .....	33
Downloading Files .....	34
Windows PC Ethernet Setup .....	34
TFTP Server Setup (Setup may vary depending on TFTP server used) .....	35
<b>HyperTerminal Setup</b> .....	<b>37</b>
Board Programming Setup .....	38
Programming Software into the Board .....	38
<b>Revision History</b> .....	<b>44</b>

## List of Figures

Figure 1. EDB9315A Board.....	5
Figure 2. EDB9315A Top View .....	7
Figure 3. Block Diagram.....	10
Figure 4. Schematic Page 1 - Block Diagram .....	19
Figure 5. Schematic Page 2 - Processor & Memory .....	20
Figure 6. Schematic Page 3 - Peripherals .....	21
Figure 7. Schematic Page 4 - UARTs & USB .....	22
Figure 8. Schematic Page 5 - mP Power .....	23
Figure 9. Schematic Page 6 - SDRAM & Flash .....	24
Figure 10. Schematic Page 7 - JTAG & CFG .....	25
Figure 11. Schematic Page 8 - Ethernet .....	26
Figure 12. Schematic Page 9 - Expansion Connector .....	27
Figure 13. Schematic Page 10 - IDE.....	28
Figure 14. Schematic Page 11 - VGA & LCD .....	29
Figure 15. Schematic Page 12 - USB2.0 Slave .....	30
Figure 16. Schematic Page 13 - Audio .....	31
Figure 17. Schematic Page 14 - Power Supply .....	32

## 1. EDB9315A Kit Contents

Each EDB9315A kit comes with the following:

- EDB9315A Development Board
- Null Modem Serial Cable
- Power Supply: +12V, 5A, 110V/220V with AC Power Cord
- Quick Start Guide
- Registration Card
- (2) IDC10-to-DB9 Cables
- IDE Ribbon Cable
- HDD Power Cable
- 3.5"-to-2.5" Notebook HDD Adapter
- 4x1 Header to HDD Power Connector Adapter
- IAR™ Evaluation CD
- Quick Start Guide
- Board Registration Card
- Trial Software Download Information Card

All documentation, schematics, software, utilities, and related information is available from the download section of the Cirrus Logic ARM Developer's web site, <http://arm.cirrus.com>.

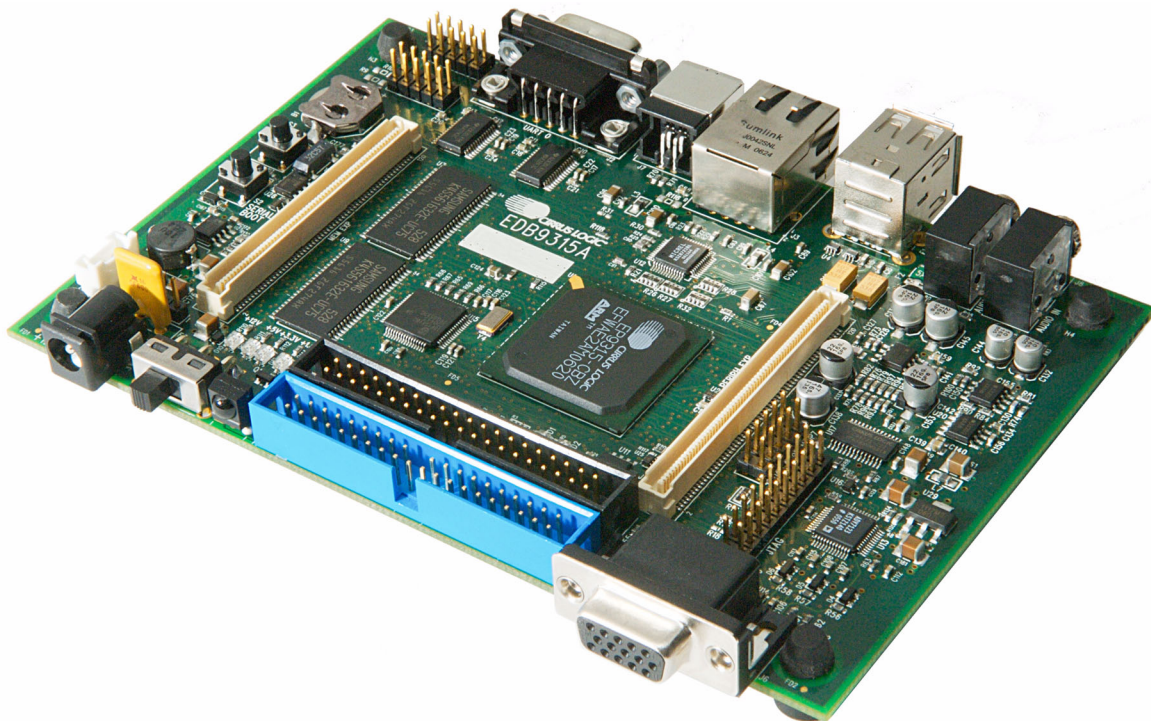

Figure 1. EDB9315A Board

---

## 2. Introducing the EDB9315A Engineering Development Board

This document will describe the features and basic operation of the EDB9315A board developed by Cirrus Logic. Detailed information regarding the operation and programming of the EP9315 device are covered by the EP9315 datasheet and User's Guide on the Cirrus Logic web site.

The EDB9315A is a convenient and easy-to-operate evaluation platform. It has been designed to provide the majority of the EP9315 functions on a small 6" x 4" base board. These features include:

- EP9315 Processor Running at 200MHz
- 64MByte SDRAM
- 16MByte NOR Flash Memory
- Two USB 2.0 Full-speed Host Ports
- USB 2.0 High-speed Device Interface
- Audio Out
- Audio In
- Three UARTs
- 10/100 Ethernet Interface
- VGA
- IDE
- JTAG
- Consumer IR (CIR)
- Expansion Connectors
- LCD Interface with Touch Screen Support

Note: The EDB9315A kit does not include a LCD screen. The LCD interface is pin-compatible with previous Cirrus Logic development boards.

Not all features of the EP9315 are on the base board. Two high-density connectors have been provided to allow for daughter card expansion. The full memory bus is connected to one of the connectors and any peripherals not on the development board are attached to the other connector. In addition, some features such as Ethernet MII interface have been brought out to the peripheral connector as well.

### 2.1 Identifying What's on the Board

Figure 2 shows the top side of the EDB9315A. The accompanying legend identifies the main components of the board.

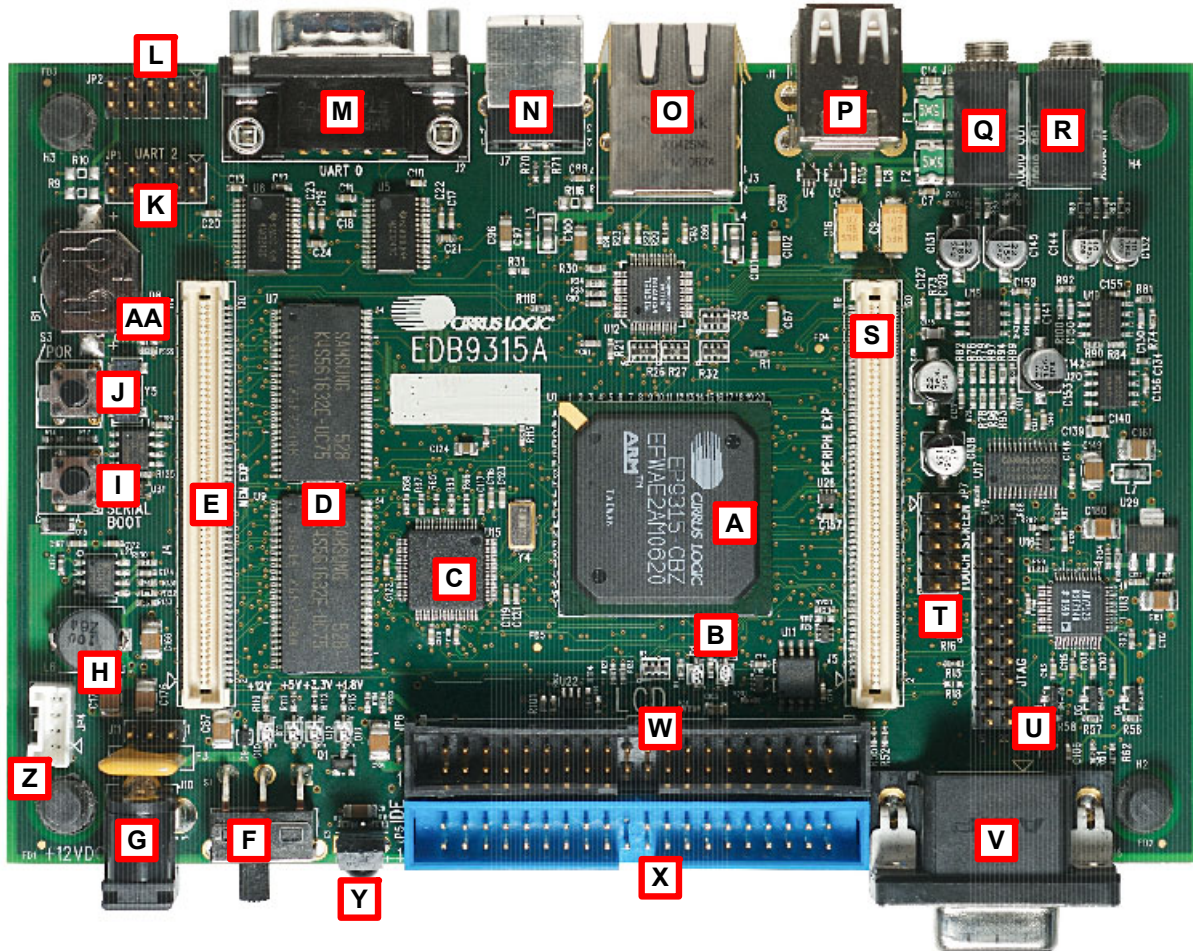

**Figure 2. EDB9315A Top View**

- |   |  |
|---|--|
| A. EP9315 processor                               | N. USB Device Connector                |
| B. Processor Status LEDs - one Red and one Green  | O. Ethernet Connector                  |
| C. USB 2.0 High-speed Device IC (ISP1581)         | P. Dual, Stacked USB Host Connector    |
| D. SDRAM - 2 16-bit devices                       | Q. Audio Out Connector                 |
| E. Memory Bus Expansion Connector                 | R. Audio In Connector                  |
| F. Main Power Switch, S1                          | S. Peripheral Bus Expansion Connector  |
| G. 12V Power Connector                            | T. Touch Screen Connector              |
| H. 3.3V Voltage Regulator - switching, 3A         | U. JTAG Connector                      |
| I. Serial Boot Pushbutton - labeled "SERIAL BOOT" | V. VGA Connector - DB15, female        |
| J. Reset Pushbutton - labeled "/POR"              | W. LCD Connector                       |
| K. UART2 Header - 5x2                             | X. IDE Connector                       |
| L. UART1 Header - 5x2                             | Y. Commercial IR                       |
| M. UART0, DB9 Male                                | Z. IDE Power Connector, +12V, +5V, GND |
|   | AA. RTC and Battery Backup             |

One item not listed above is the Flash device. It is located on the bottom side of the board, under item C. There are no jumpers on the board. The only "jumper" is the serial boot pushbutton. This button is used when the developer wants to use the Cirrus Logic download utility to put new code into Flash memory.

## 3. Getting Started

### 3.1 Before you Begin...

The developer will find it useful to have some additional hardware not provided in the EDB9315A kit. Items such as a USB mouse, USB keyboard, VGA monitor and cable, and a set of powered speakers can make using the EDB9315A and the software installed on the board more enjoyable.



**Caution: Make sure you are in a static-free environment and are following proper procedures for handling ESD-sensitive electronic equipment.**

### 3.2 Attaching Cables

Before attaching cables to the board make sure you know where pin 1 for each of the connectors is located. Most connectors are keyed. However, some connectors use 2 x n headers, allowing the cable to be plugged in backwards. Prime examples of this are the Touch Screen and JTAG connectors.

There is silkscreen on the PCB identifying each connector and its pin 1 location. Make sure to pay attention to the markings on the PCB for the pin 1 location. The pin 1 identifier is marked by either a number or a triangle.

### 3.3 Before Applying Power...

In order to use the EDB9315A the user must first connect the peripherals to the EDB9315A as described in the following procedure.

1. Place the EDB9315A on a static free surface.
2. Make sure power switch S1 is in the OFF position.
3. Connect the 12V power supply provided to the board at J10.
4. Connect null modem serial cable provided in the kit from DB9 connector J2 to a serial port on a PC or notebook (if so equipped).
5. Connect a VGA monitor to DB15 connector J6.
6. Launch a terminal program, such as minicom or HyperTerminal. Configure the PC com port for: 38400 baud, 8 data bits, no parity, 1 stop bit, no flow control for WinCE and 57600 baud for Linux.
7. Connect the board to a network that has internet access (optional)
8. Connect a USB mouse and keyboard.
9. Turn power switch S1 to the ON position and the board will boot and shortly display the WinCE 5.0 or



---

the Qt/Opie desktop on the VGA monitor, depending which OS you have programmed into the board. The EDB9315A comes with WinCE 5.0 installed.

**NOTE:** The WinCE 5.0 binary is not provided on the support web site. If you erase the image on the board, you will have to download the BSP provided by Cirrus Logic and compile it using Platform Builder.

Due to changes in distribution policy, the Microsoft trial CD/DVD that was formerly included in the kit is no longer available. Please refer to the card in the kit that describes how to download the Microsoft trial software from the Microsoft web site.

## 4. EDB9315A Circuit Description

This chapter makes reference to the schematics in Appendix A and discusses the main circuit functionality of each schematic page. A detailed block diagram of the EDB9315A Engineering Development Board is shown below.

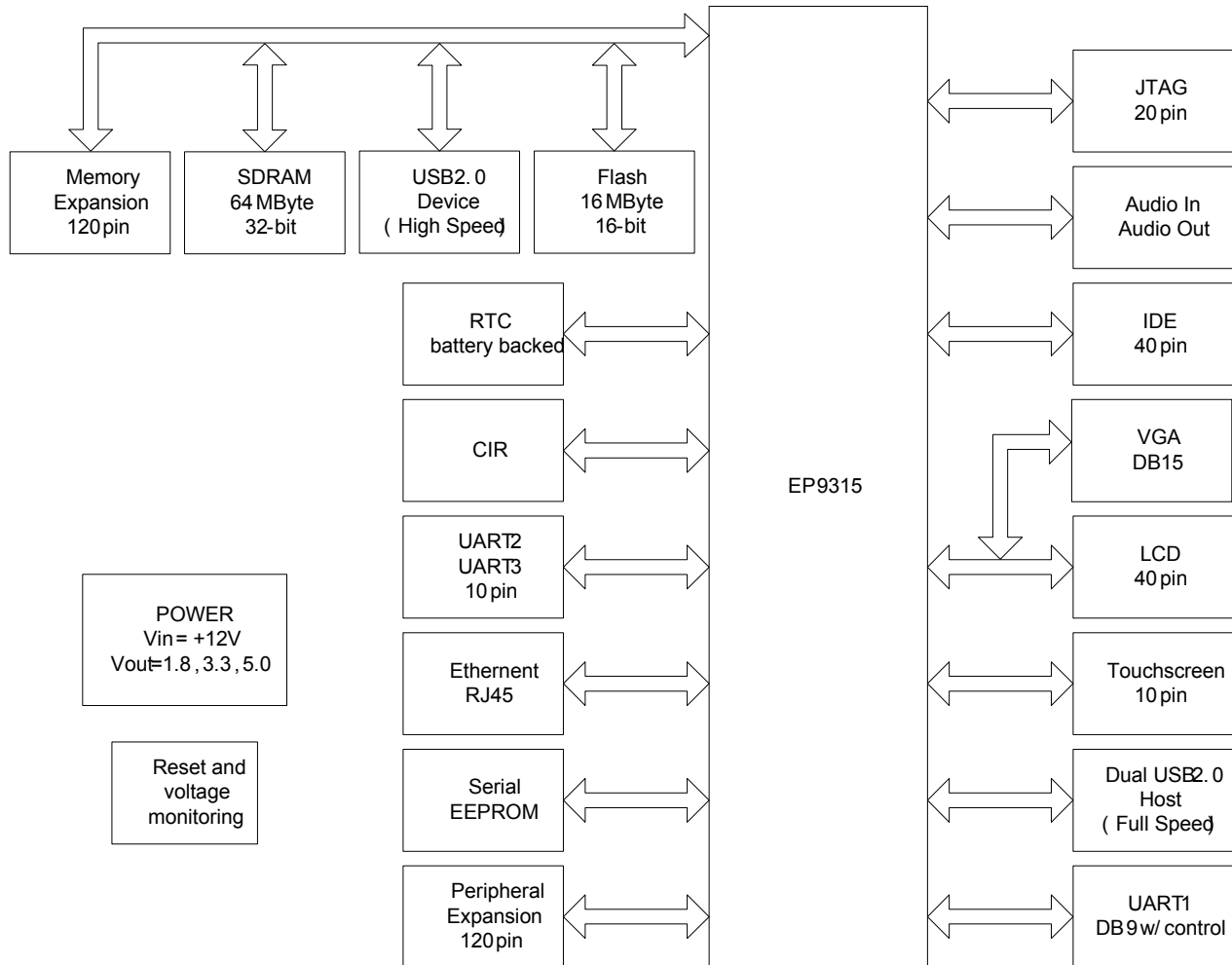

**Figure 3. Block Diagram**

Detailed information regarding the EP9315 processor and interfaces can be found at [www.cirrus.com](http://www.cirrus.com). The details of this device will not be discussed in this document. Refer to the EP9315 datasheet, User's Guide, and other information on the web site for more information.

## 4.1 Circuit Operation

The major circuit operation for each page of the schematic will be discussed.

Note: Refer to <http://arm.cirrus.com> for the latest board schematics. Look under the download link at the top of the page.

### Page 1

Block diagram and revision history.

### Page 2

There are two main clock inputs to the EP9315 device. One is the 14.7456 MHz crystal oscillator and the other is the 32.768 kHz real time clock (RTC).

The 14.7456 MHz clock can be generated from a crystal circuit as shown in the schematics, or optionally from a 14.7456 MHz oscillator. If a 14.7456 MHz oscillator is used, then only the XTALI pin is driven and the drive level of the clock must be 3.3 V.

The RTC clock may be generated by the circuit shown in the schematics, or optionally an RTC oscillator. Due to the cost of RTC oscillators, the circuit shown in the schematics is used. An external oscillator is made by using an unbuffered '04 inverter. It is very important to use an unbuffered inverter in this application. Using a buffered inverter may make the circuit oscillate in the ~MHz range or not start at all. Refer to application note AN265.

The two LEDs connected to the EP9315 device are used to indicate processor health during boot and general status of the board.

The reset output, RSTON (active-low signal) is buffered by U25. There is a resistor option for the RSTON signal to be either driven by this buffer or bypassed. If the reset signal is not going to be buffered, U25 must be removed and R117 installed. By default, RSTON is buffered.

### Page 3

This block shows the peripheral connections from the EP9315 processor.

### Page 4

Main items on this page are the USB 2.0 Full-speed Host, USB power, UART, and Commercial IR (CIR) circuits.

The USB Host circuits are connected directly from the EP9315 to U3 and U4 and then on to the stacked USB connector, J1. U3 and U4 provide termination for the USB signals and ESD protection. Note that only two of the three USB ports are routed to USB connectors, the remaining USB port is routed to the Peripheral Expansion header. Power for the USB Host ports comes from the +5V switching regulator and is protected with poly fuses rated for 0.5 A each.

The board has all three UARTs brought out. The main UART interface, UART0, is connected to a standard male DB9 connector and provides for full modem control. The other two UART interfaces are connected to 5x2 headers. There is an option for installing zero-ohm resistors if the developer needs to provide +5V power to an external device. The pinout of the headers matches common IDC10-to-DB9 cables. Two such cables are included with the kit. All UART signals are level shifted from TTL to RS-232.

The CIR uses an enhanced GPIO (EGPIO) line to communicate to the EP9315 device.

---

## Page 5

This is the power section for the EP9315 device. The ADC and PLL supplies are filtered. There is no reason to filter the 3.3 and the 1.8V power rails.

## Page 6

The SDRAM interface is comprised of two 16-bit SDRAM devices to form a 32-bit SDRAM bus. The SDRAM is connected to /SDCS0 and is located at physical memory address 0xC000\_0000. Single 32-bit SDRAM devices may be used as well.

The Flash interface is made from a single 16-bit device. It uses a "multi-cell" Flash device. The Flash device is connected to /CS6 and is located at physical memory address 0x6000\_0000. The reference design uses only one Flash device. However, the EP9315 can be designed with a 32-bit Flash interface as well. The Flash device installed is a 128 Mbit, 16 Mbyte, device.

The serial EEPROM is a 4 Mbit device and may be used for serial "SPI Boot" or for storing the Ethernet MAC address. SPI Boot is not used as the default boot method but may be used by the developer if it fits his/her application. Details about SPI Boot are in the EP9315 User's Guide. The serial EEPROM is accessed only if the EGPIO7 line is configured to the proper level. The SPI™ frame signal and the EGPIO7 "enable" signal are OR'ed to create the enable for the serial EEPROM device. EGPIO7 must be low in order to communicate to the serial EEPROM. Other devices on the SPI bus must be enabled in a similar manner but not enabled simultaneously.

Note: EGPIO7 should be pulled low instead of pulled high. If SPI Boot is desired, remove R201 and pull down EGPIO7.

## Page 7

The JTAG interface is connected to a 2x10 header, JP3. This connector is wired for the Multi-ICE debugger.

There are 10 signals that determine how the EP9315 will boot and operate. They are all shown on this page except for BOOT1. BOOT1 is connected to GND. BOOT1 is used for factory testing only. The other nine signals are either pulled up or down external to the EP9315 device. The boot configuration shown sets the EP9315 device to perform an Internal Async boot from a 16-bit-wide memory.

The "Serial Boot" pushbutton, S2, is used to configure the board to perform a serial boot. A serial boot is used to program the Flash device with the Cirrus Logic download utility. Instead of using jumpers, a pushbutton is used. Simply hold the pushbutton down while pressing and releasing the reset pushbutton, S3. Continue to hold S2 until the red LED turns off. Once the red LED is off, release S2.

The ISL1208 is connected to the EP9315 to provide an external, battery backed RTC clock. This device has 2 bytes of battery backed SRAM. The battery is a common lithium coin cell and easily removable if desired.

## Page 8

The Micrel KS8721BI PHY is used to provide the 10/100 Mbit Ethernet interface. The PHY is attached to the EP9315 device MII interface. The PHY also connects to RJ45 connector, J3. The Ethernet connector has integrated magnetics and status LEDs. The Micrel PHY requires external power filtering of the 2.5V supply it produces.

---

**Page 9**

The two connectors provide a daughter card interface for making custom circuits. J4 is the Memory Expansion connector and J5 is the Peripheral Expansion connector.

The entire memory bus is connected to J5. It is recommended that the bus signals be buffered if adding additional memory. However if a CPLD or FPGA is attached there is no reason to buffer. Use proper engineering practices when using the high-speed memory bus with daughter cards.

The Peripheral Expansion bus has the signals for features not implemented on the EDB9315A board and for commonly used signals.

**Page 10**

The IDE interface is connected from the EP9315 device to the IDE connector, JP5, through series termination resistors. These pins are 5V tolerant.

A hard disk drive (HDD) and/or CD-ROM can be connected to the board with the IDE cable provided. Simply plug the blue end of the IDE cable into the blue IDE connector, JP5. Power for the drive(s) is provided by plugging the IDE power cable (included) into the IDE power connector, JP4.

If using a notebook HDD, please use the included 3.5"-to-2.5" IDE power adapter.

**Page 11**

Two video interfaces are provided. The main video interface is VGA. An LCD interface is also provided however there is no LCD screen included with the development kit. The LCD interface is pin compatible with previous Cirrus Logic ARM9 development boards. A 4-wire touch screen interface is also included and is pin compatible with previous Cirrus Logic ARM9 development boards.

**Page 12**

An external USB 2.0 High-speed Peripheral device is provided. The USB device allows a Host to see the board as a Mass Storage device. The USB interface chip is connected to the lower 16-bits of the memory bus.

**Page 13**

Audio is supported by a Cirrus Logic CS4271 device. Two-channel audio out and line-level audio in is supported. The audio device communicates to the EP9315 through the I<sup>2</sup>S interface and audio clocks are generated by the EP9315. The audio in is line level, it is not a microphone-level input. Like the serial EEPROM, the CS4271 is controlled by the SPI frame signal and EGPIO6. EGPIO6 must be low in order to communicate to the CS4271 device. As mentioned before, only one SPI™ device can be enabled at a time.

---

## Page 14

Power and reset circuits are shown on this page. Most of the changes made to this revision of the EDB9315A board were made in this section. The most important change made is that the board is now powered from a +12V power supply instead of the former +5V supply.

The board has two connectors for input power. J10 is the standard power connector and is where the power supply provided in the kit attaches. However, a 3x1 header, J11 is also available to supply power to the board.

The 3.3V power rail is generated from a 3A, adjustable, switching regulator, U27. The 5V power rail is generated from an identical 3A switching regulator, U28. The 5V supply requires a diode, D7. The 3.3V supply does not require this diode.

The 1.8V power rail is generated from an 800mA linear regulator. Both the 3.3V and 1.8V power rails are monitored by U22 and it will issue a reset if either supply falls below the threshold voltage.

The reset pushbutton can connect directly to the voltage monitor reset input or to a supplementary reset-detect circuit. Refer to AN258 for more information. This circuit is implemented by U24 and some passive devices. In general, this circuit is not required with EP9315 Rev E2 devices and may be removed if desired. It is installed by default. If removed, R109 needs to be installed if the use of the reset pushbutton is desired.

---

## 5. Software

### 5.1 Overview

The software programmed into the Flash on the EDB9315A development board is WinCE® 5.0. Linux® 2.6.8.1, from Cirrus Logic, running Qt/Opie is also available for the EDB9315A board

The WinCE 5.0 image programmed into Flash by the factory is not available from Cirrus Logic directly. This image can not be provided to users due to distribution and royalty reasons. If the developer decides to overwrite the factory WinCE 5.0 Flash image with Linux or some other software, and then later desires to put the WinCE 5.0 image back into Flash, they must obtain the WinCE 5.0 BSP from their Cirrus Logic FAE and build the image themselves using the trial version of Platform Builder™ or with a version of Platform Builder they have purchased. Only WinCE 5.0 supports the EDB9315A board. Cirrus Logic technical support for WinCE 4.2 is not available.

Cirrus Logic provides complete source for its Linux 2.6 offering. The Cirrus Logic release images for the EDB9315A are also provided for those who do not want to build the toolchain and environment or want a quick way to load Linux onto the board. If, however, you wish to implement functionality other than that provided in the release package images, you must download the gcc toolchain from the Cirrus Logic User's Development Forum, under the download link at the top of the page <http://arm.cirrus.com/files/tools> . The other method is to download the buildroot package from the same location and let it download and build all the appropriate packages and toolchain.

Note: Linux development should be done on a Linux PC, not under Windows. Cirrus Logic uses Debian as the default build environment. Red Hat® and other versions of Linux may be used as well, but Cirrus Logic Linux 2.6. development is done under Debian.

### 5.2 Download Utility

The download utility provides the user with a tool for programming the flash memory on the EDB9315A Development Board with a binary image. Two versions of the download executable are provided: one supporting a PC running Windows/DOS, and one supporting a PC running Linux. The following procedure will allow in-circuit programming of the flash memory via the EP9315 processor:

1. Connect null-modem serial cable to the DB9 connector on the board and to the PC.
2. Run the download utility; make sure all terminal windows are "Disconnected" Assuming the download utility is located in same directory as the binary image...
  - a. For Windows: download binary\_image\_filename.bin
  - b. For Linux: download binary\_image\_filename.bin
3. "Waiting for board to wake up..." message is displayed on the PC.
4. Press and hold down pushbutton S2 "SERIAL BOOT"
5. Press and then release pushbutton S3 "/POR"
6. Wait for the red LED to go off then release pushbutton S2.
7. Messages will be displayed regarding erasing, then programming the flash.
8. "Successfully programmed binary\_image\_filename.bin" message displayed upon programming completion.
9. Press pushbutton S3 to reboot the board with the new code image.

## 6. Developer's User Forum

Many references have been made to the Cirrus Logic Developers User's Forum in this document.

The Cirrus Logic Developers User's Forum is a company-sponsored site and moderated by Cirrus Logic employees. However, it is not the technical help line for the Cirrus Logic ARM® product line. It is intended to be a place where developers can share ideas and ask questions from others.

Developers should become familiar with the Developer's User Forum and the files provided under the download link. Both software and hardware files are provided for Cirrus Logic offerings. Refer to Chapter 7 for useful information related to the Cirrus Logic ARM products.



---

## 7. Other Useful Information

### Web Sites

- Cirrus Logic main web site: [www.cirrus.com](http://www.cirrus.com)
- Developer's Web Site: [arm.cirrus.com](http://arm.cirrus.com)
- Registration Web Site: [www.cirrus.com/boardreg](http://www.cirrus.com/boardreg)

### Processor Information

The following information is located on the [www.cirrus.com](http://www.cirrus.com) web site.

- EP9315 Datasheet
- EP9315 User's Guide
- EP9315 Errata

### Application Notes

The following information is located on the [www.cirrus.com](http://www.cirrus.com) web site.

- AN273, *"EP93xx Silicon Rev E Design Guidelines"*
- AN265, *"EP93xx RTC Oscillator Circuit"*
- AN258, *"EP93xx Power-up and Reset Lockup Workaround"*

### Board Information

The following information is located on the [arm.cirrus.com](http://arm.cirrus.com) web site.

- EDB9315A Technical Reference Manual
- Schematics
- BOM
- Artwork and PCB stackup

### Code Information

The following information is located on the [arm.cirrus.com](http://arm.cirrus.com) web site.

- Linux 2.6
- Board utilities
- Tools

Contact a Cirrus Logic FAE for information regarding the following.

- WinCE 5.0 BSP

The documents listed above are updated periodically and may be more up to date than the information in this document. Check with the web sites for the latest updates.

## Appendix A. Schematics

The schematics for the EDB9315A Development Board are located on the Cirrus Logic Developer's Forum website ( [arm.cirrus.com](http://arm.cirrus.com) ). The schematics are provided in Adobe's portable document format (PDF) and PADS™ format. OrCAD™ versions of the schematics are not available.

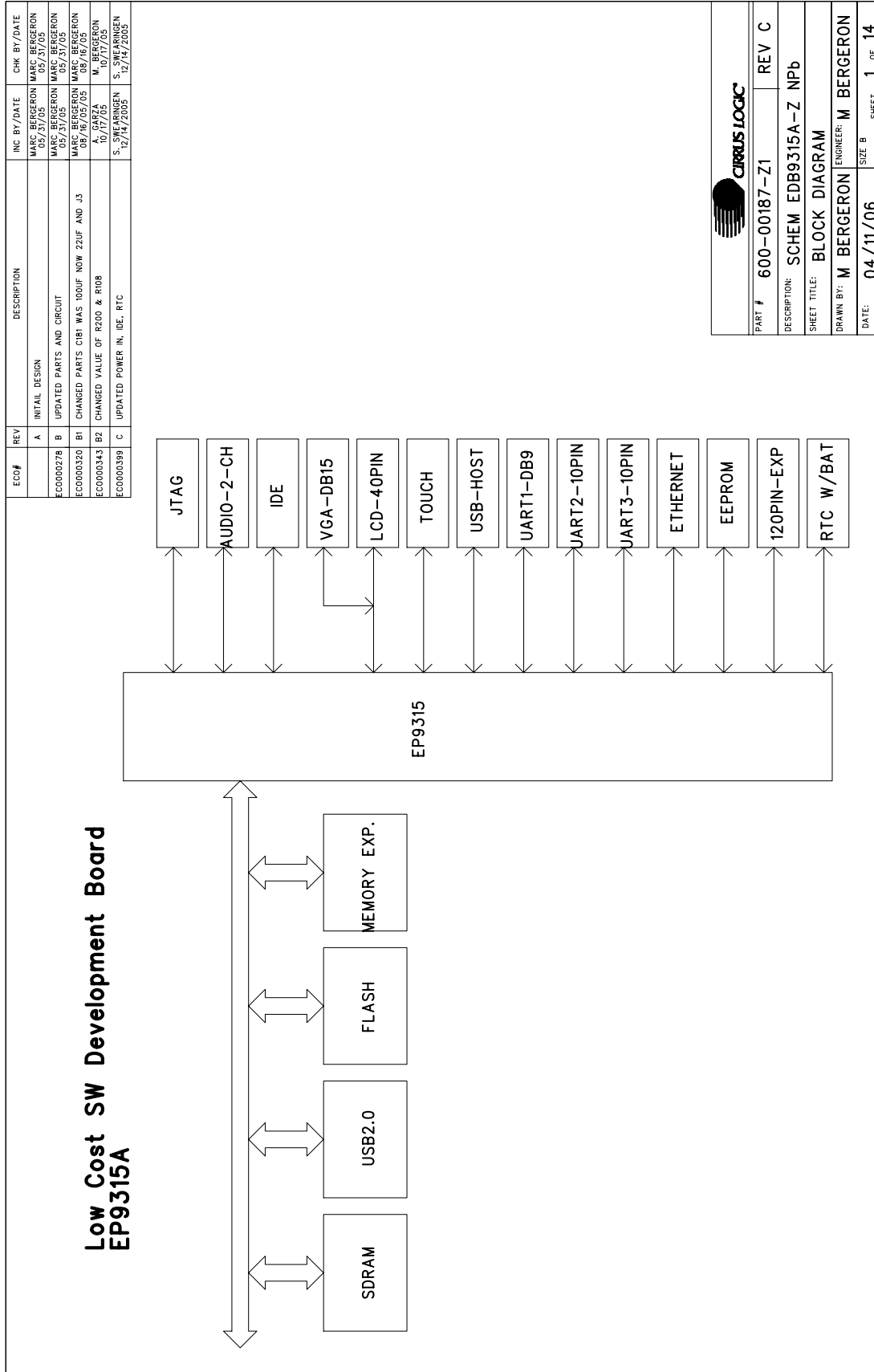
**Figure 4. Schematic Page 1 - Block Diagram**

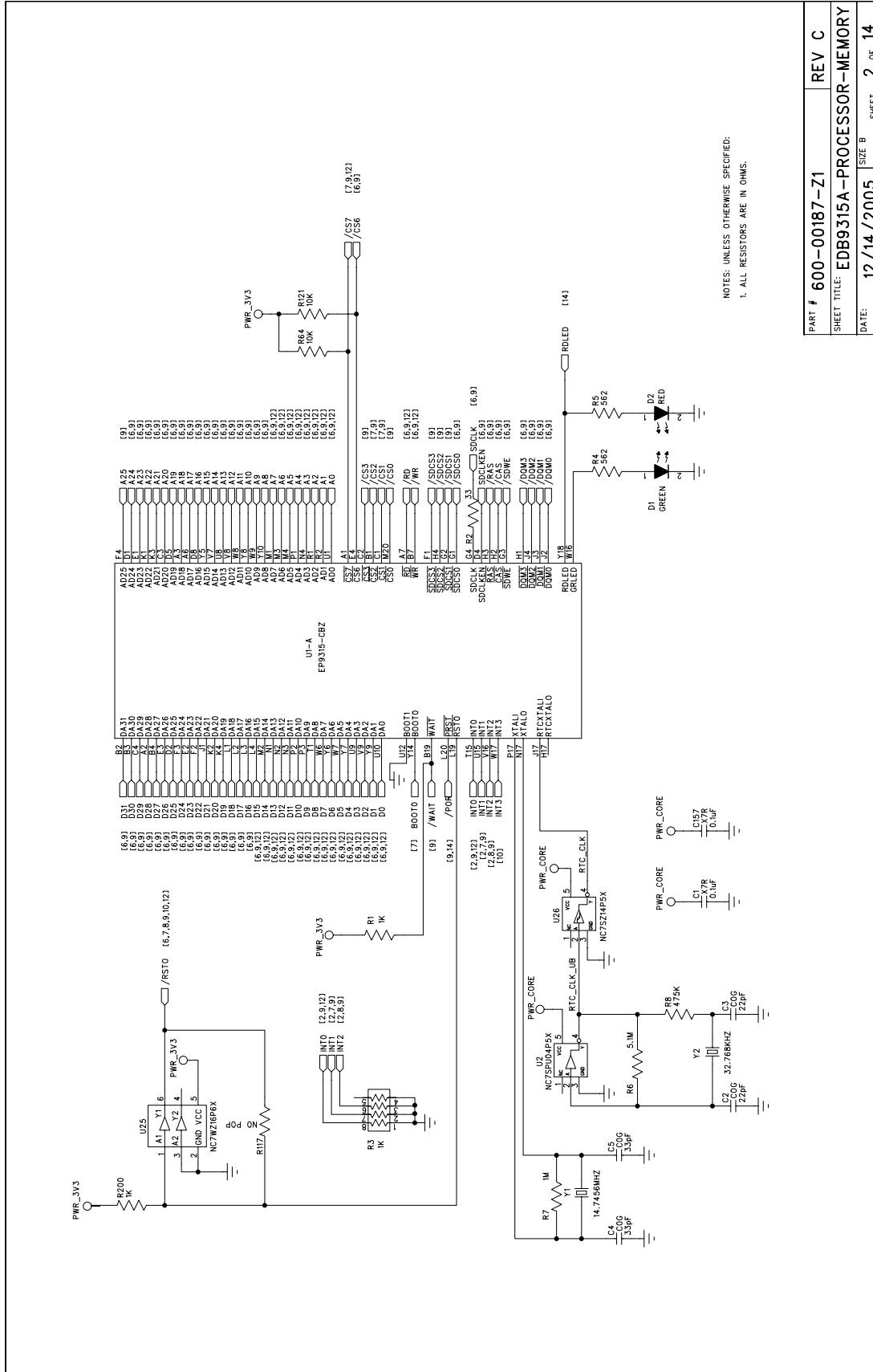

PART #	600-00187-Z1	REV	C
SHEET TITLE:	EDB9315A-PROCESSOR-MEMORY		
DATE:	12/14/2005	SIZE	B
		SHEET	2 OF 14

Figure 5. Schematic Page 2 - Processor & Memory



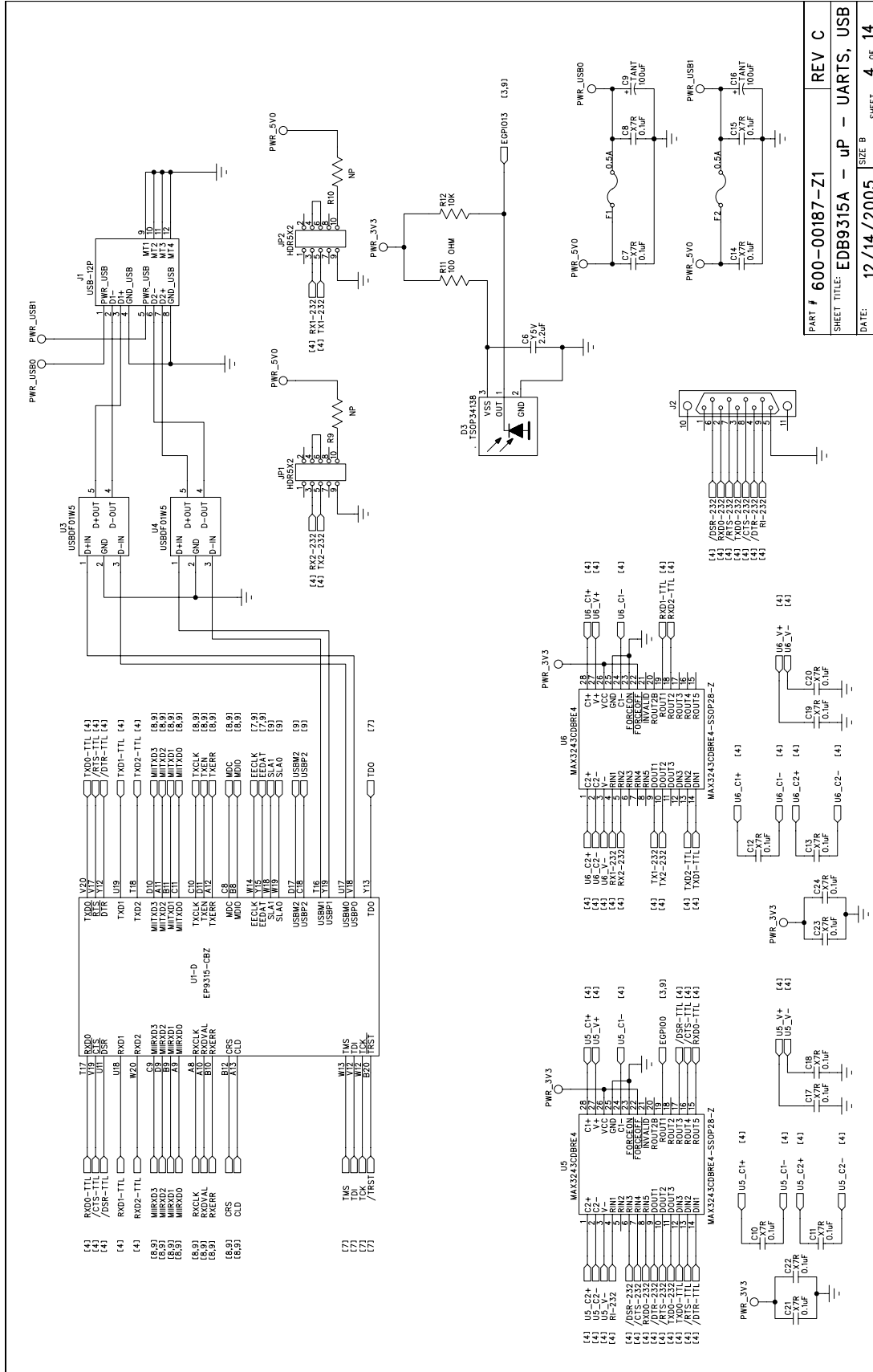
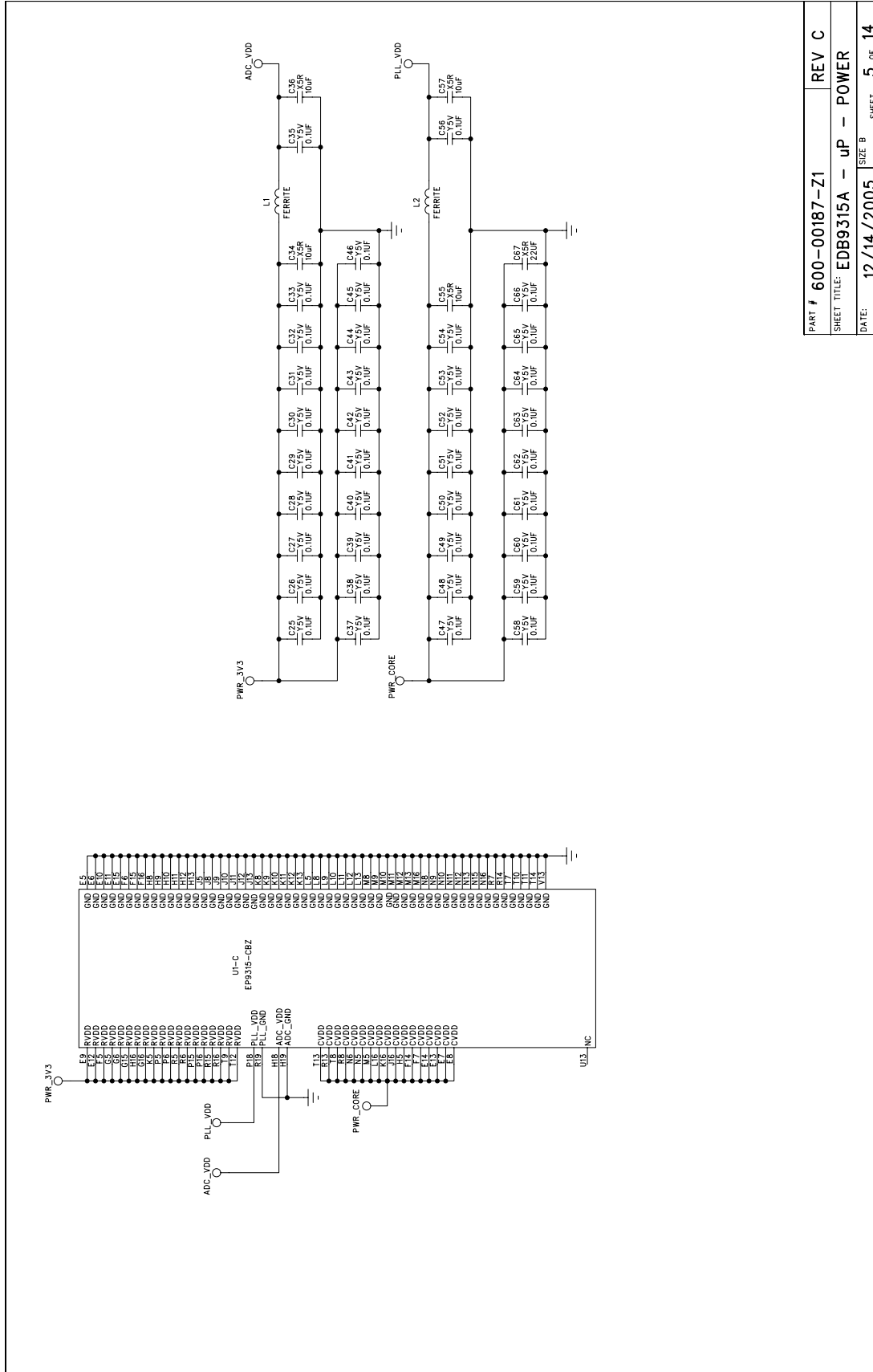
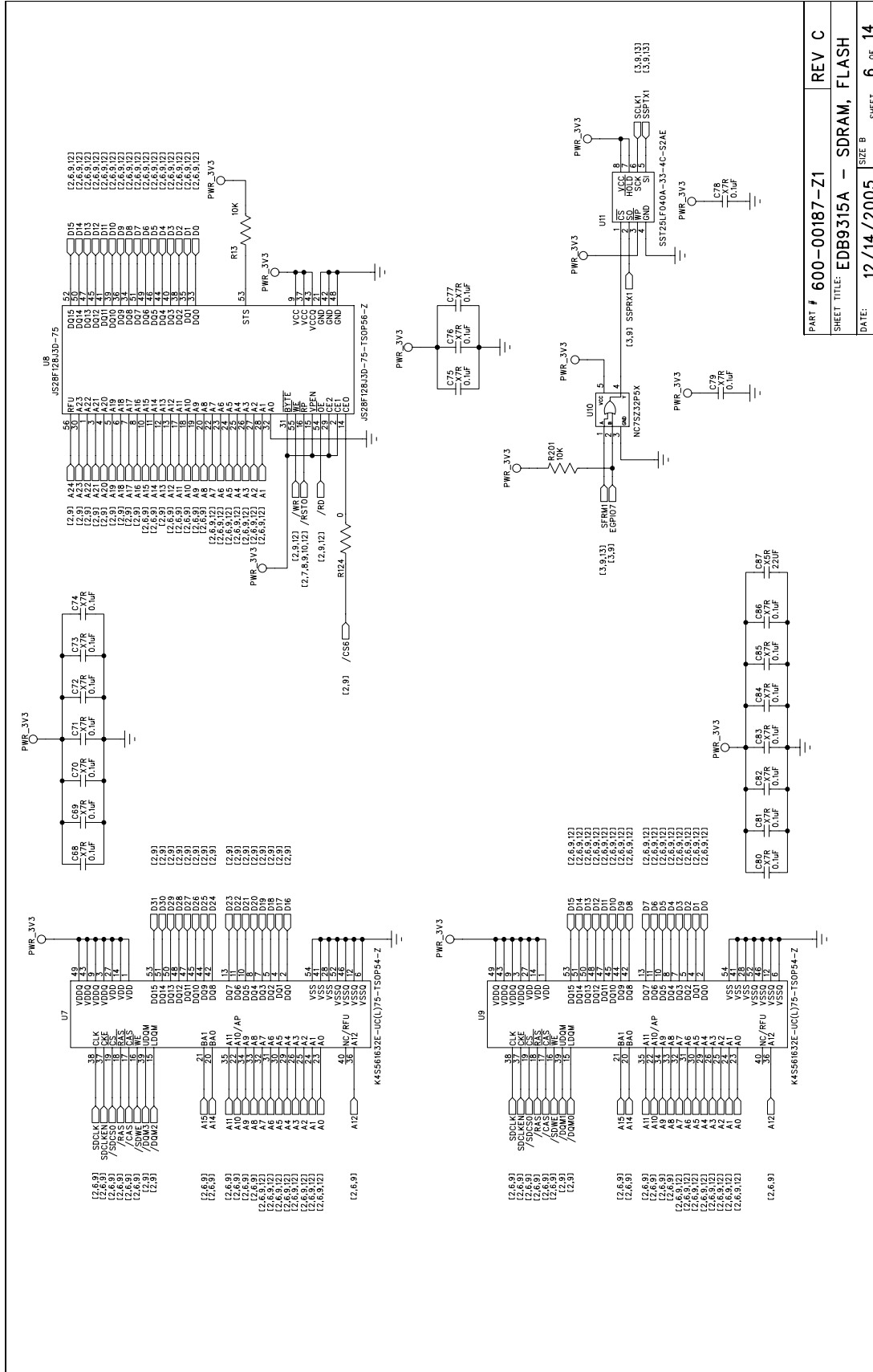

Figure 7. Schematic Page 4 - UARTs & USB



PART #	600-00187-Z1	REV	C
SHEET TITLE:	EDB9315A - uP - POWER		
DATE:	12/14/2005	SIZE	B
		SHEET	5 OF 14

**Figure 8. Schematic Page 5 -  $\mu$ P Power**



PART #	600-00187-Z1	REV C
SHEET TITLE:	EDB9315A - SDRAM, FLASH	
DATE:	12/14/2005	SHEET 6 OF 14

Figure 9. Schematic Page 6 - SDRAM & Flash



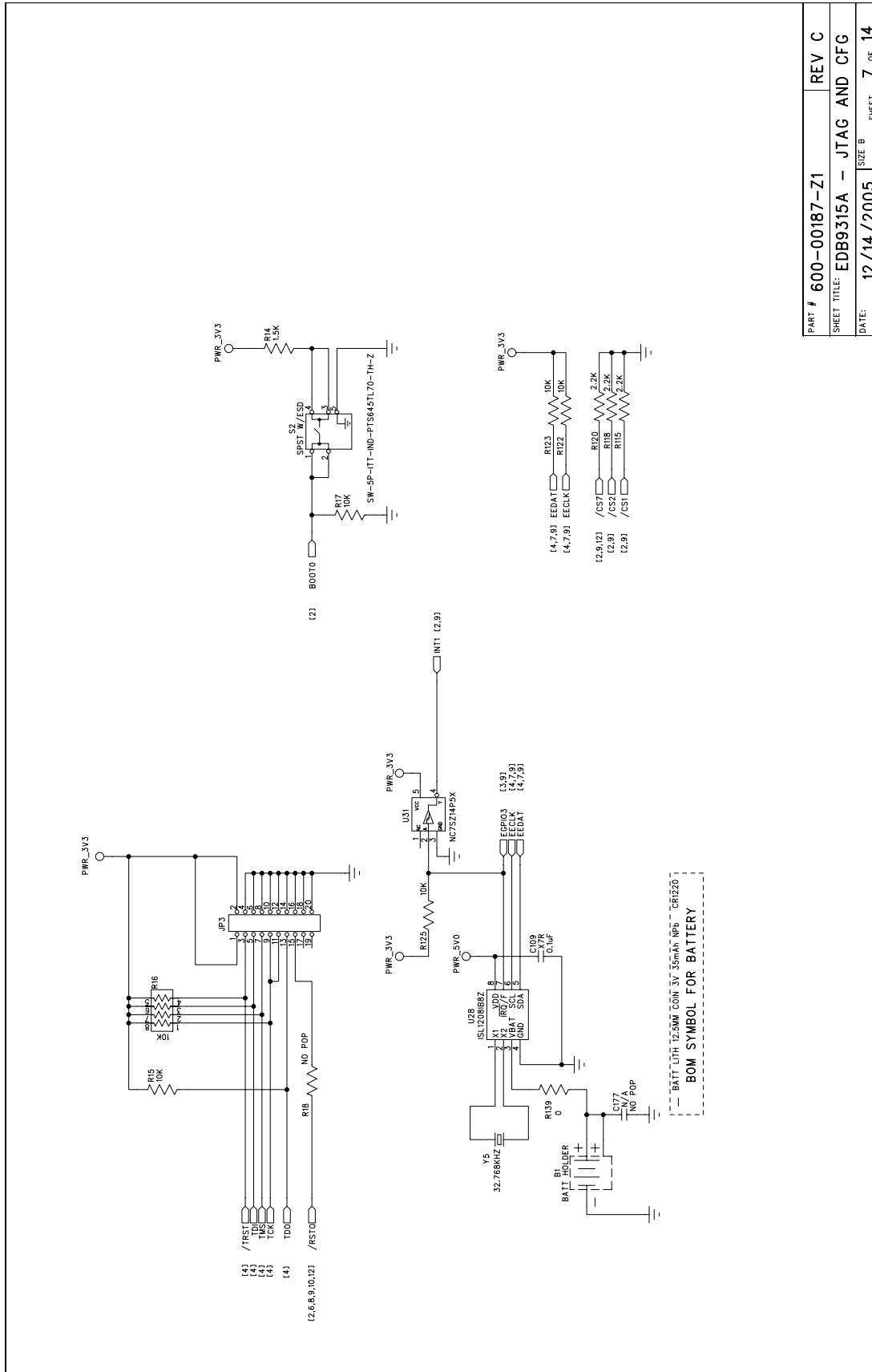

PART #	600-00187-Z1	REV	C
SHEET TITLE:	EDB9315A - JTAG AND CFG		
DATE:	12/14/2005	SIZE B	SHEET 7 OF 14

**Figure 10. Schematic Page 7 - JTAG & CFG**

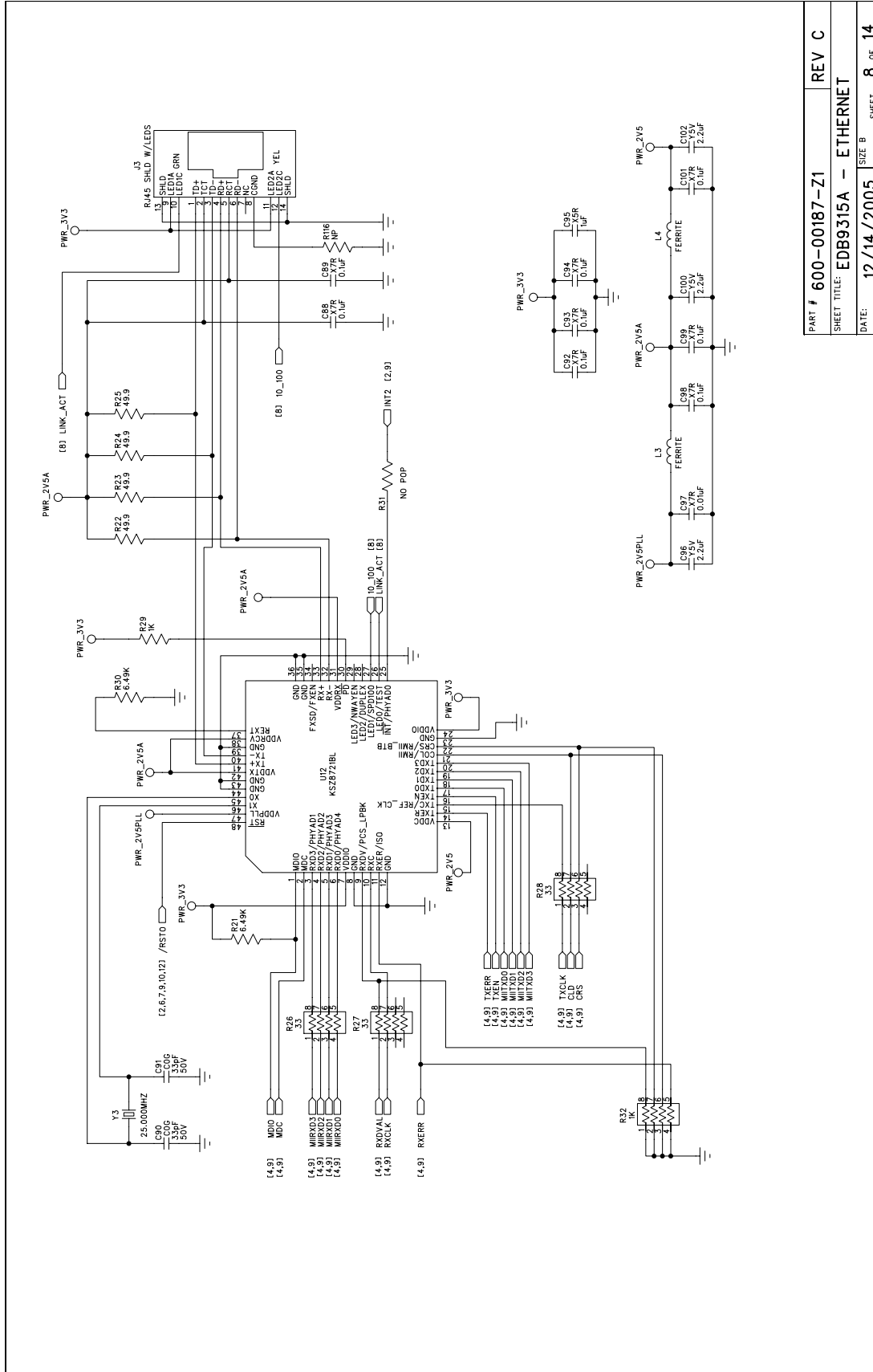

PART #	600-00187-Z1	REV	C
SHEET TITLE:	EDB9315A - ETHERNET		
DATE:	12/14/2005	SIZE	B
		SHEET	8 OF 14

Figure 11. Schematic Page 8 - Ethernet

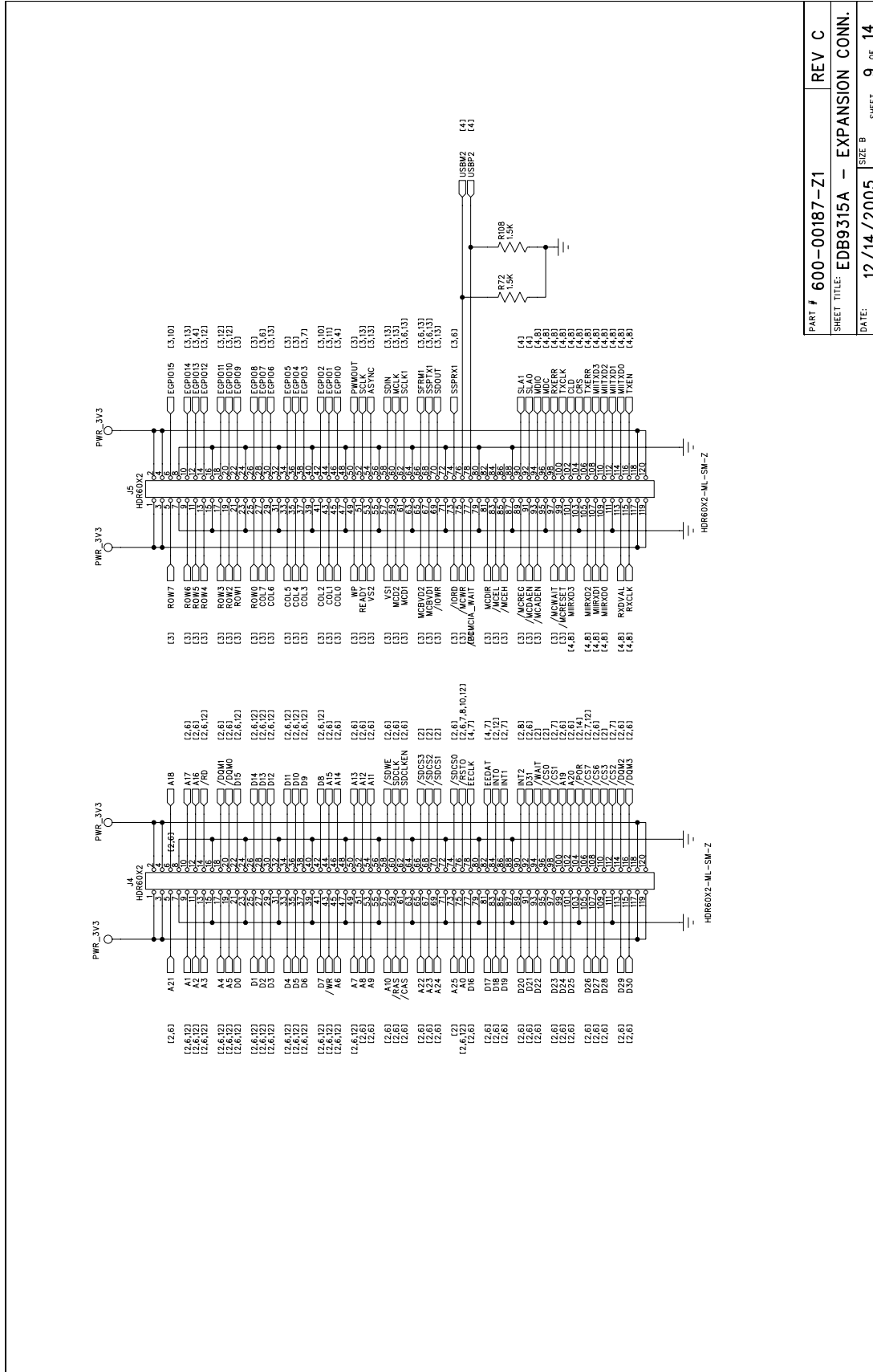

PART # 600-00187-Z1	REV C
SHEET TITLE: EDB9315A - EXPANSION CONN.	
DATE: 12/14/2005	SIZE B SHEET 9 OF 14

**Figure 12. Schematic Page 9 - Expansion Connector**

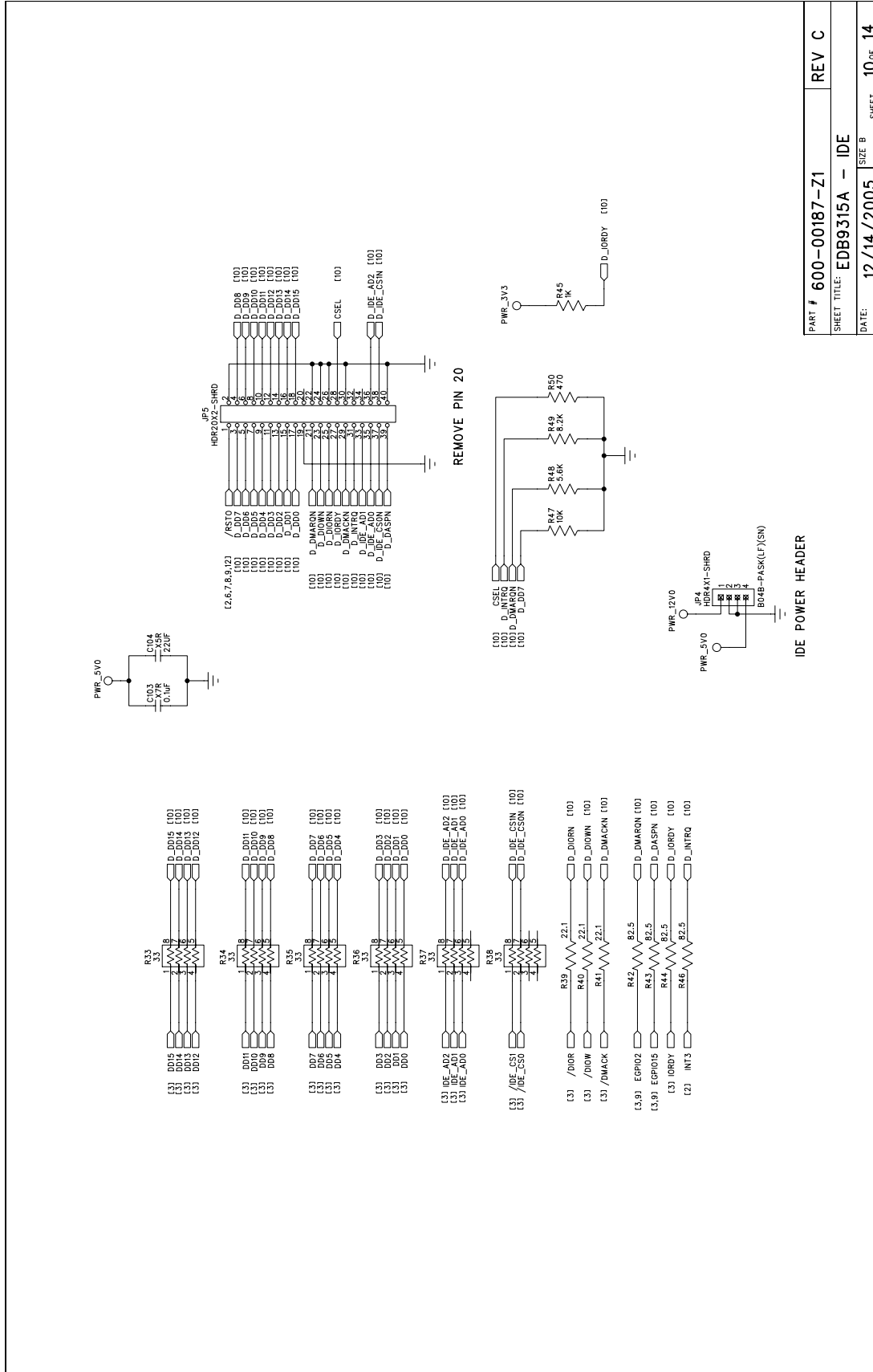

PART #	600-00187-Z1	REV C
SHEET TITLE:	EDB9315A - IDE	
DATE:	12/14/2005	SIZE B SHEET 10 OF 14

Figure 13. Schematic Page 10 - IDE

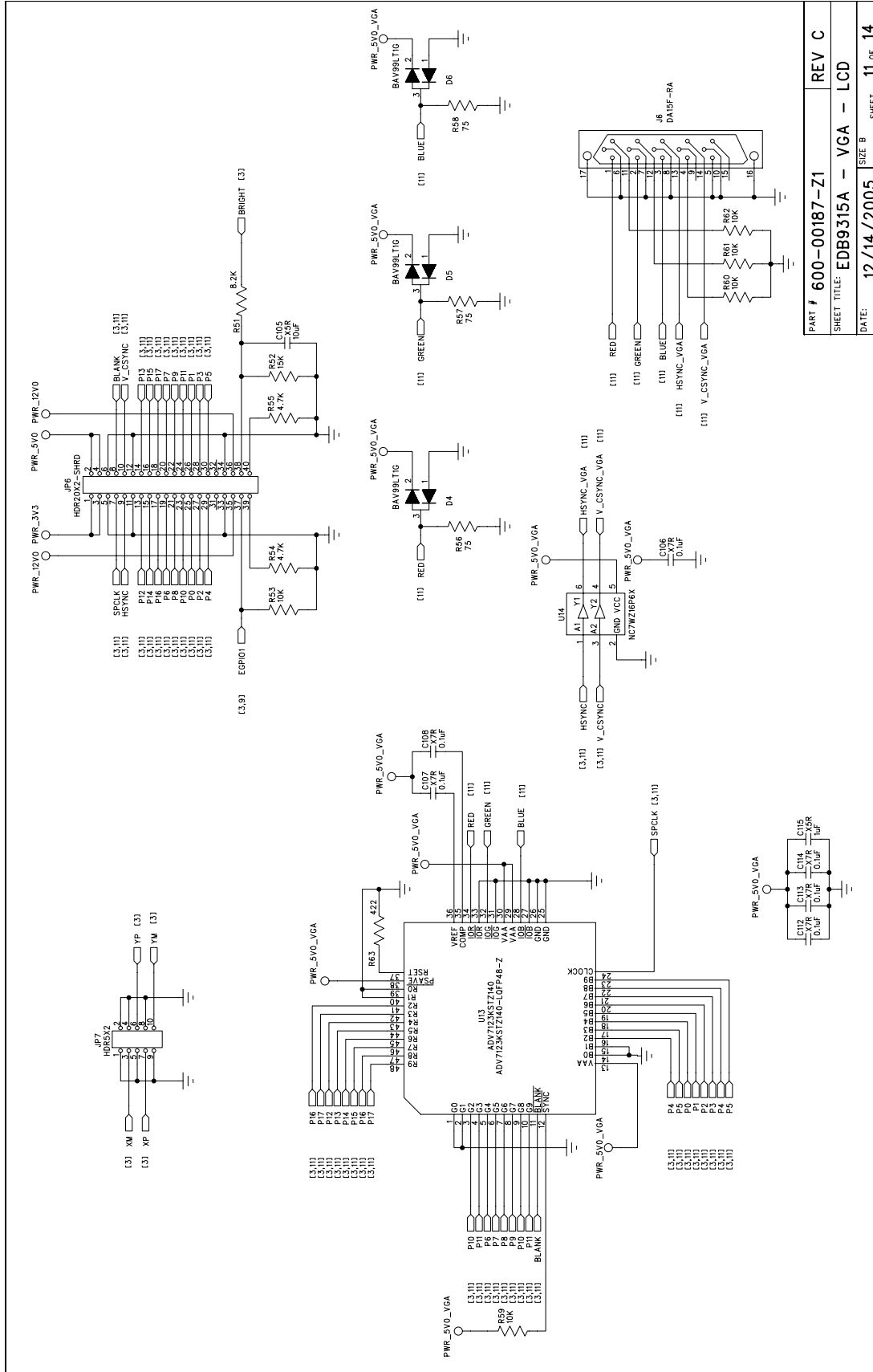
**Figure 14. Schematic Page 11 - VGA & LCD**

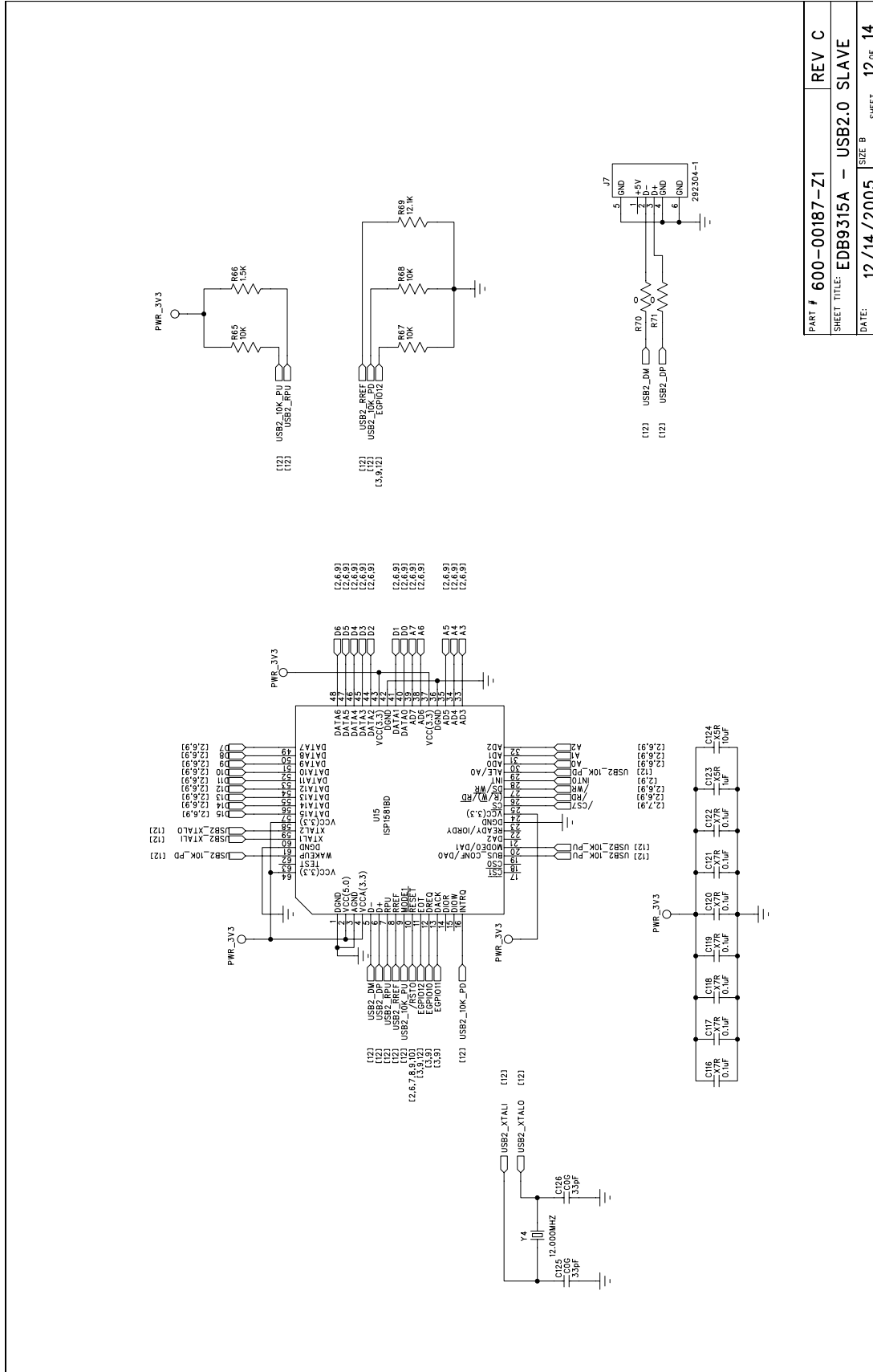

PART # 600-00187-21	REV C
SHEET TITLE: EDB9315A - USB2.0 SLAVE	
DATE: 12/14/2005	SIZE B SHEET 12 OF 14

Figure 15. Schematic Page 12 - USB2.0 Slave

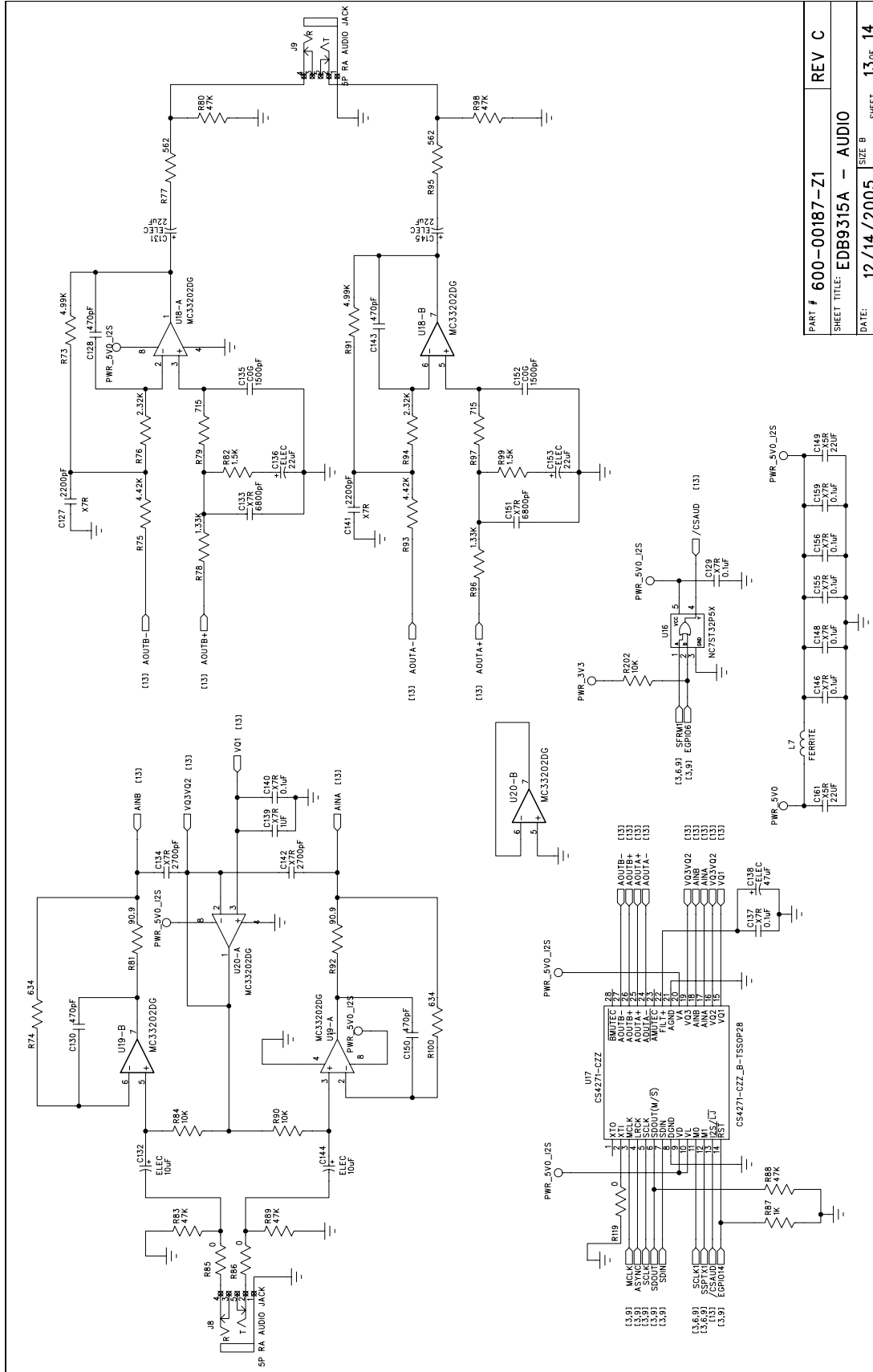

PART #	600-00187-Z1	REV	C
SHEET TITLE:	EDB9315A - AUDIO		
DATE:	12/14/2005	SIZE	B
		SHEET	13 OF 14

Figure 16. Schematic Page 13 - Audio

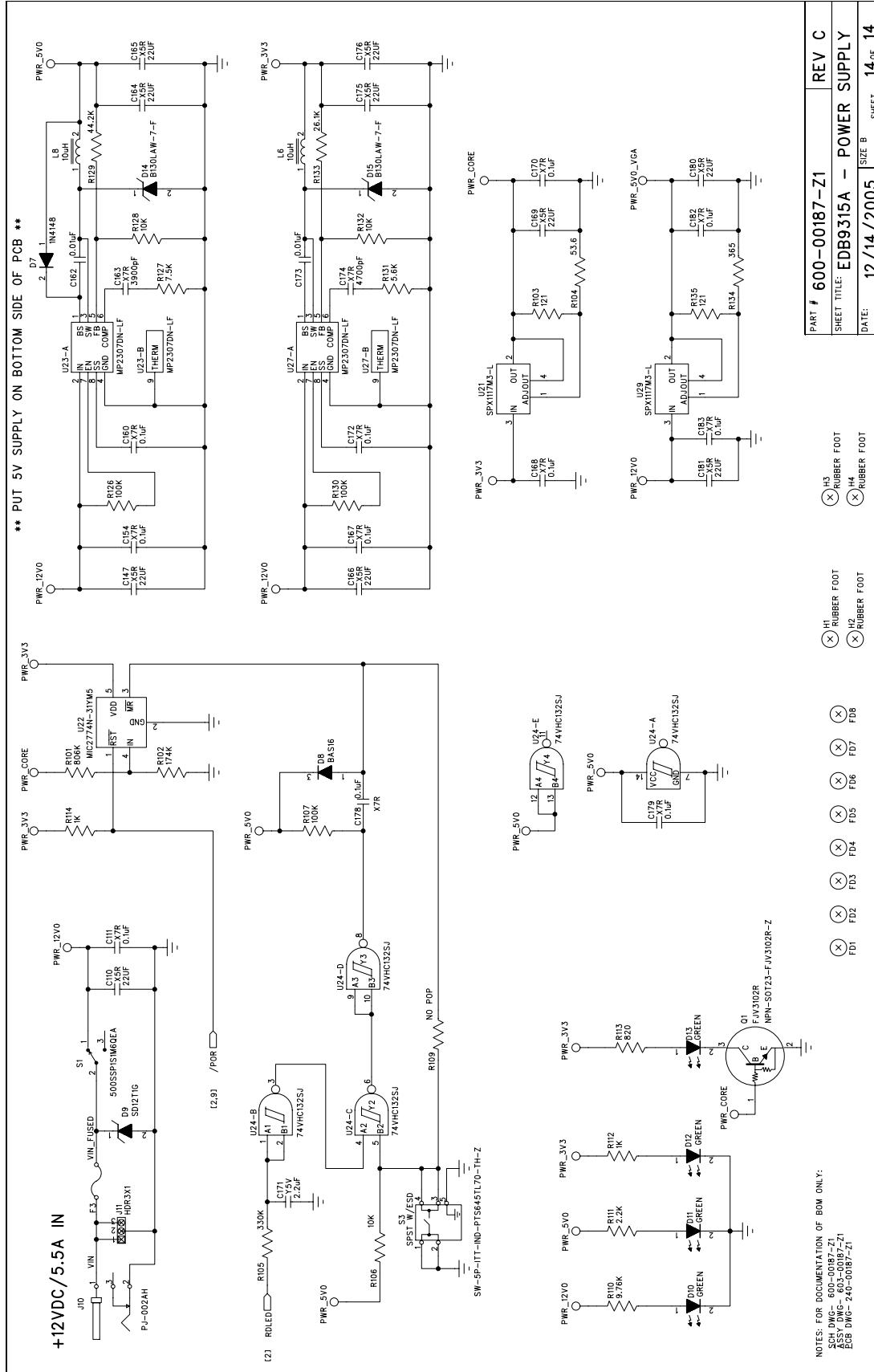

Figure 17. Schematic Page 14 - Power Supply



---

## Appendix B. Programming Linux Images into Flash from a Windows® PC

For those people who want to program Linux images onto the board but do not have a Linux PC.

### Materials and Equipment Needed

A. +12V, 5 amp power supply, provided with kit

B. Computer

- Must be running Windows® 2000 or Windows® XP with SP2 installed on a Pentium® III or better with at least 256M RAM.
- Must have at least one (1) serial port with DB9 connector.
- Must have at least one (1) Ethernet 10/100 port with RJ45 connector.
- Must have HyperTerminal software (comes with Windows 2000/XP).
- Must be able to connect to the Internet and download files from web site.
- Monitor, keyboard and mouse.

C. Cables

- One DB9 Null Model cable with female to female connectors, provided with kit
- One Ethernet cross-over cable, not provided with kit

D. Software

Linux images are provided by Cirrus Logic. The Linux files are on the <http://arm.cirrus.com> website. Click on the download link at the top of the page.

The files are in various directories and depend on the kernel version, build revision and board type you need.

<http://arm.cirrus.com/files/linux/releases/linux-2.6/1.0.4/edb9315A> has the image files:

*redboot.bin*, *zImage* and *ramdisk.gz*

Look for the version you are interested in and download the pre-built images.

Go to <http://arm.cirrus.com/files/tools> to get the Windows download utility called, *download.zip*.

E. PC Software

- TFTP software

F. Hardware

- VGA monitor for the EDB9315A board

*Note: The instructions and screen shots in this Appendix make reference to the SolarWinds 6.0 TFTP server program. This program is not provided by Cirrus Logic. Other TFTP server programs may work equally well but will need to be verified by the developer.*

## Downloading Files

1. Make a directory called "TFTPROOT" on C:\
2. Use a computer that has an Internet connection and download the files specified in "D. Software" to the directory made in step 1.
3. Disconnect the Ethernet cable if using Wired Ethernet. Plug in the Ethernet cross-over cable into the computer's Ethernet port.

## Windows PC Ethernet Setup

1. Go to *Control Panel*, click on *Network Connections*. Click on the Ethernet port icon representing the RJ45 port on the computer. In the scroll box, go to the end and double click on the item called *Internet Protocol (TCP/IP)*.
2. Under the *General* tab, enable *Use the following IP address* and configure per the picture below. When done, click on *OK* and then *OK* again for changes to take effect.

*Note:* The IP address can be any address you chose, just make sure it matches the IP address you use in the fconfig step below.

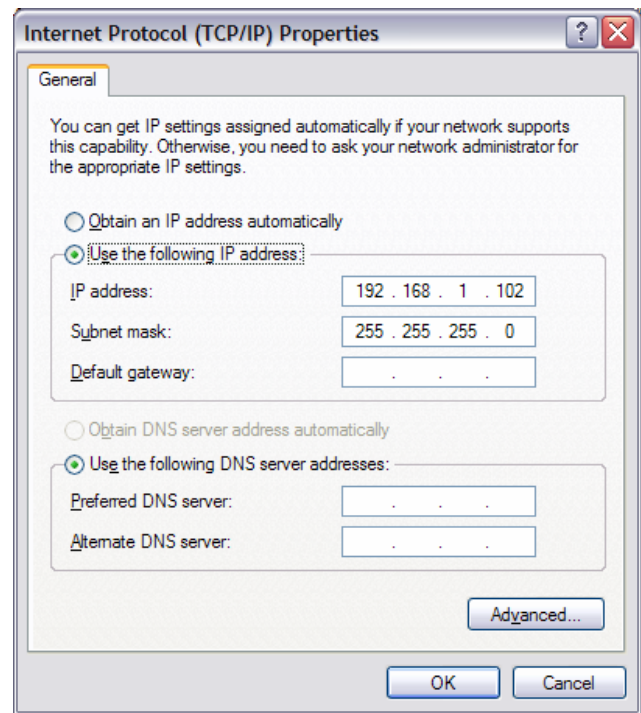
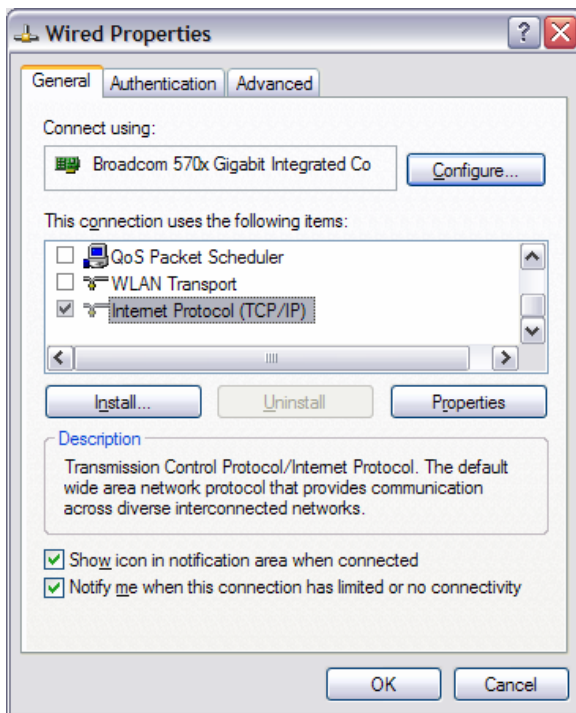

## TFTP Server Setup (Setup may vary depending on TFTP server used)

1. Install the TFTP Server program on the Windows PC and select the default configuration.
2. You may have to disable the firewall if using Windows XP.



3. Once the program is installed, run the TFTP Server program.
4. Configure the TFTP Root directory to point to `C:\TFTPROOT`.
5. Select the Security Tab and make sure the Client access is *Transmit and Receive files*. See the pictures below.

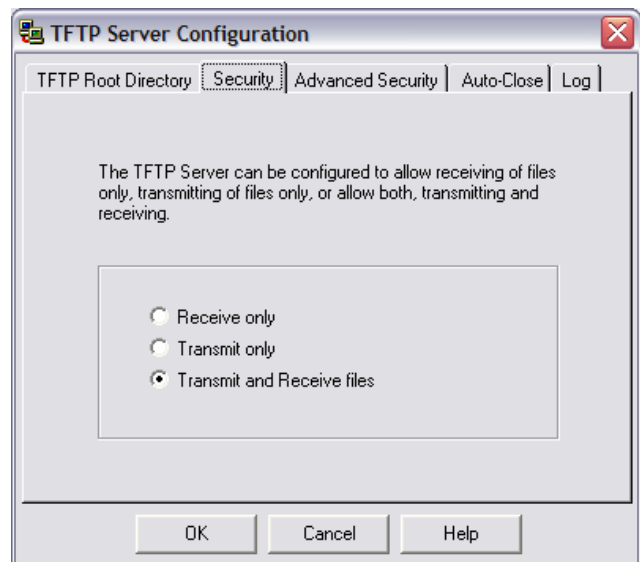
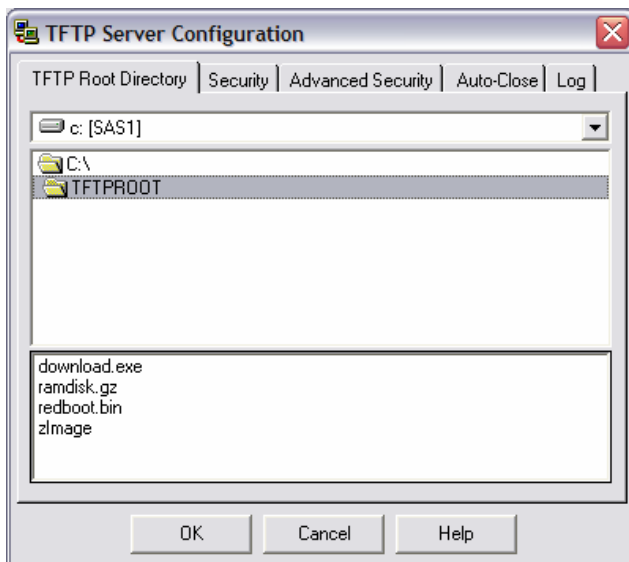

6. Verify that the Auto-Close setting is set to "Never".

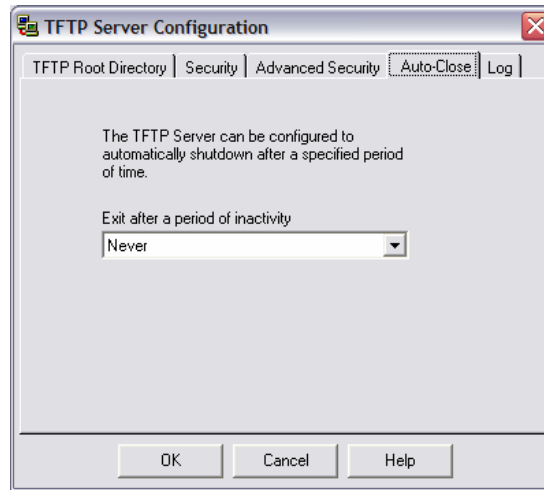

7. When complete, click the OK button. You should see a screen like the picture below. Note that the directory is located in the status bar at the bottom left. Additionally, the IP address the TFTP Server is "listening" to is located in the lower right.

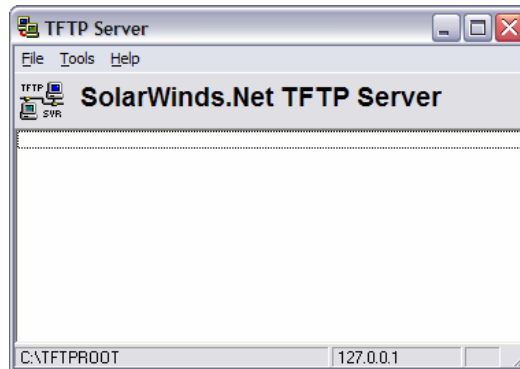

*Note: Note: You may get an IP address of 127.0.0.1 because the EDB9315A board does not have the boot loader code programmed yet. This is ok. Simply quit the TFTP server program. Instructions on when to start the program will be given during the board programming section. If an IP address other than the one above appears, the Ethernet port is connected to something and should be removed.*

## HyperTerminal Setup

Run the HyperTerminal program and configure to use COM1 and to run at 57600 baud, 8 data bits, no parity, one (1) stop bit (8-N-1) and NO hardware control flow. It should look like the picture below when complete. Note you have to "Disconnect" in order to make configuration changes. Click "Call" once the configuration is complete.

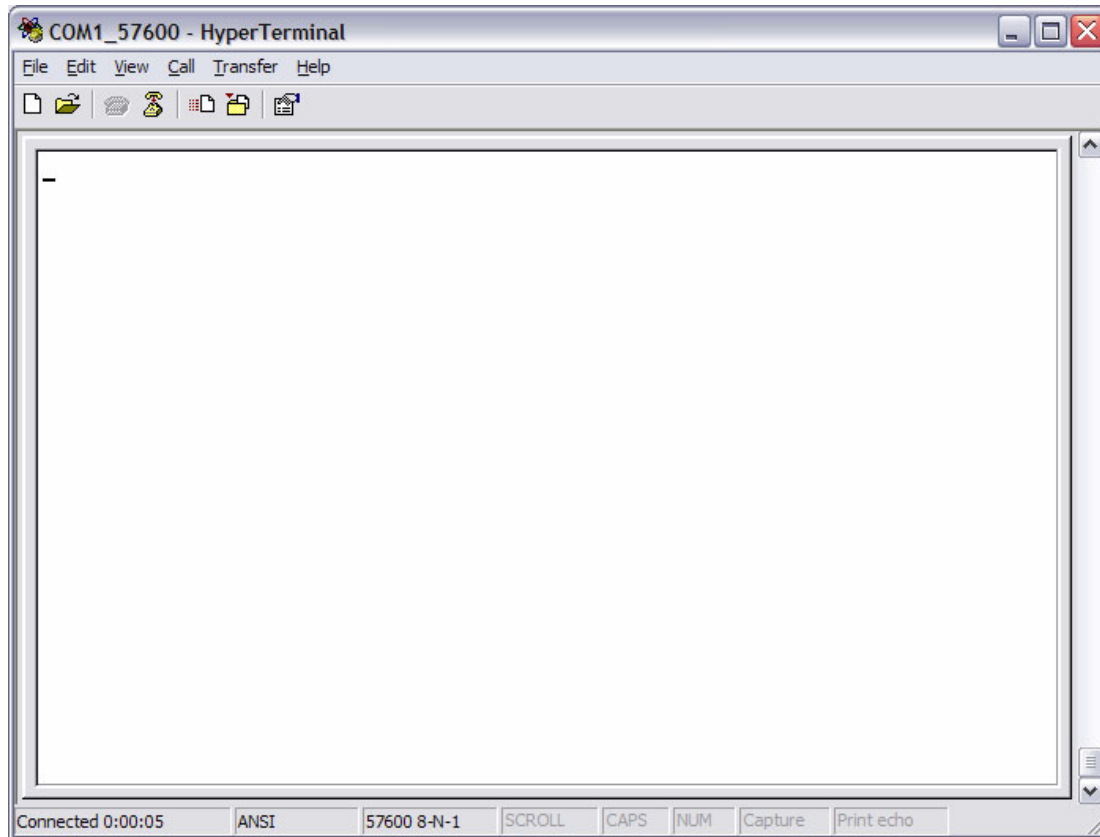

## Board Programming Setup

1. At this point, the RJ45 Ethernet port on the Windows PC is configured, HyperTerminal is running, the TFTP server is running, the Cirrus Logic software has been downloaded to the C:\TFTPBOOT directory and the board is powered up.
2. Connect one end of the Null Modem cable to J2.
3. Connect the other end of the Null Modem cable to the COM1 port on the Windows 2000/XP computer.
4. Connect the other end of the Ethernet cross-over cable to J3. A green LED in the J3 Ethernet connector should light up.
5. Turn on the VGA monitor and plug the VGA monitor cable into DB15 connector J6.
6. Open a "Command Prompt" window so DOS commands can be issued.
7. Go to the C:\TFTPBOOT directory by typing "cd\tftpboot"
8. Click the "Disconnect" button in HyperTerminal to disable serial communication. HyperTerminal has to be disconnected whenever the download.exe program is executed.

## Programming Software into the Board

1. From the Command Prompt, type the following command: *download redboot.bin*.

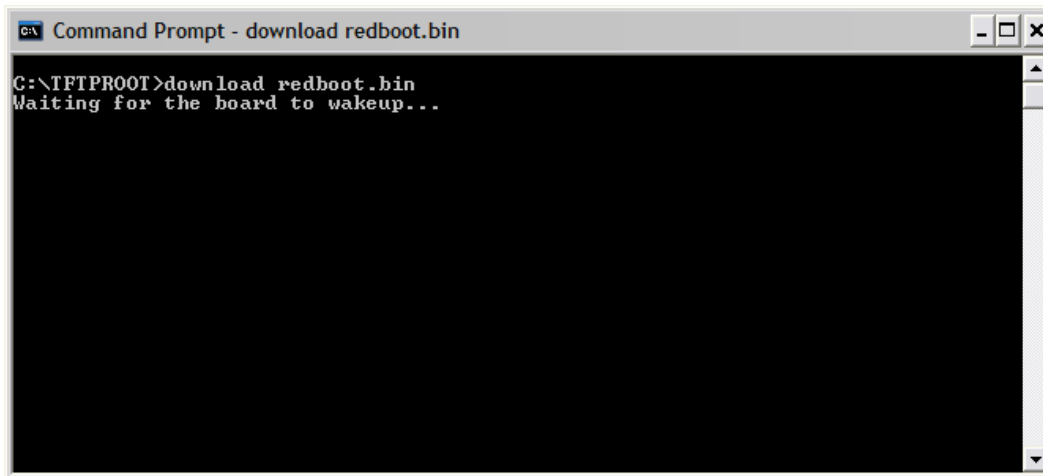

```
Command Prompt - download redboot.bin
C:\TFTPBOOT>download redboot.bin
Waiting for the board to wakeup...
```

2. At this point, the download program is waiting for the user to press AND hold down pushbutton S2 *SERIAL BOOT*. While holding down S2, press and release pushbutton S3 */POR*. Keep holding down S2 until red LED, D2 (next to the flashing green LED) is no longer illuminated. Afterwards, release S2. You should then see the following in the Command Prompt window.

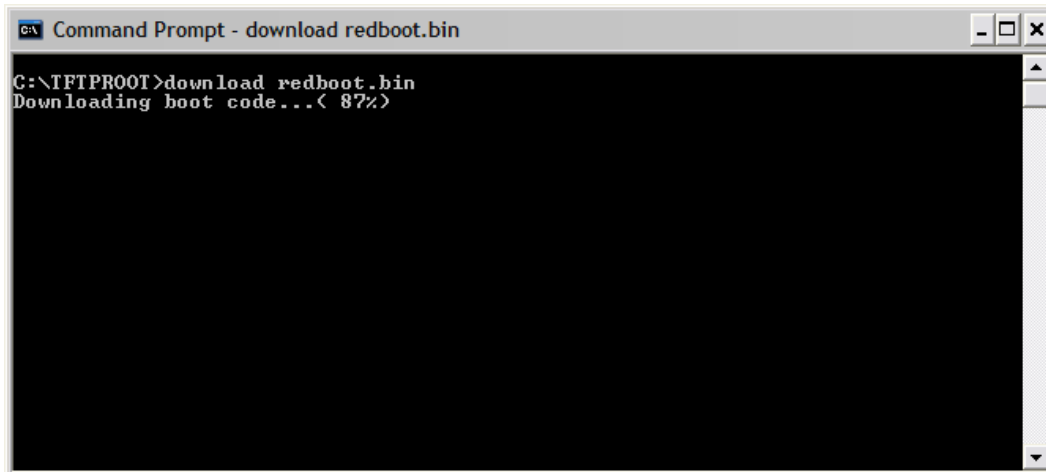

```
Command Prompt - download redboot.bin
C:\TFTPBOOT>download redboot.bin
Downloading boot code...< 87%>
```

*download.exe* Downloading the Code

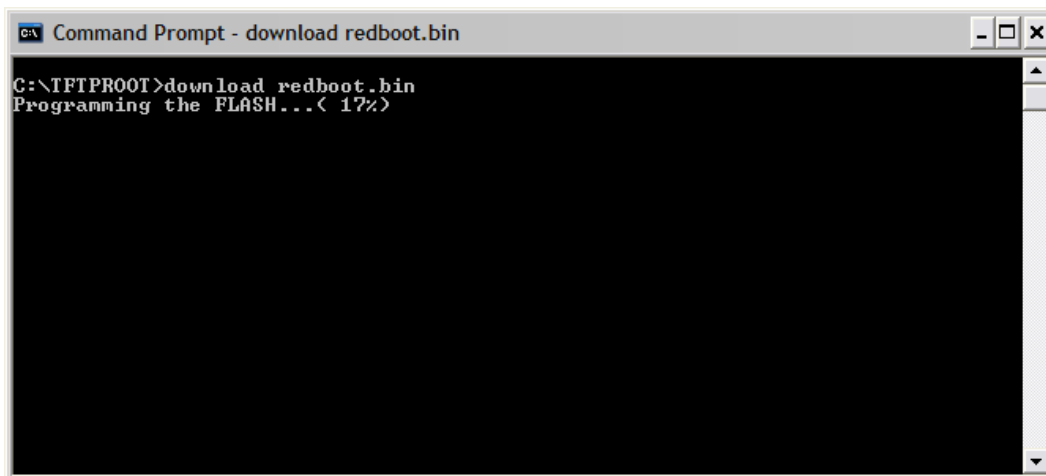

```
Command Prompt - download redboot.bin
C:\TFTPBOOT>download redboot.bin
Programming the FLASH...< 17%>
```

*download.exe* Erasing then Programming the Flash Memory

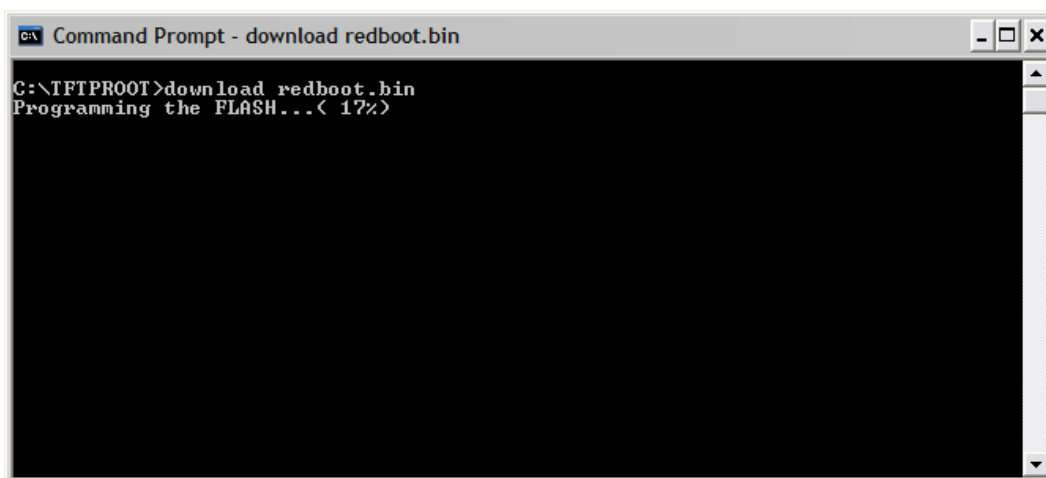

```
Command Prompt - download redboot.bin
C:\TFTPBOOT>download redboot.bin
Programming the FLASH...< 17%>
```

*download.exe* Successfully Programming *redboot.bin*

3. Redboot.bin has been programmed into Flash memory. Go to HyperTerminal and re-establish serial communication to the board by pressing the *Call* button.
4. Press and release pushbutton S3, */POR*. The board will reboot and eventually display information in the HyperTerminal window.

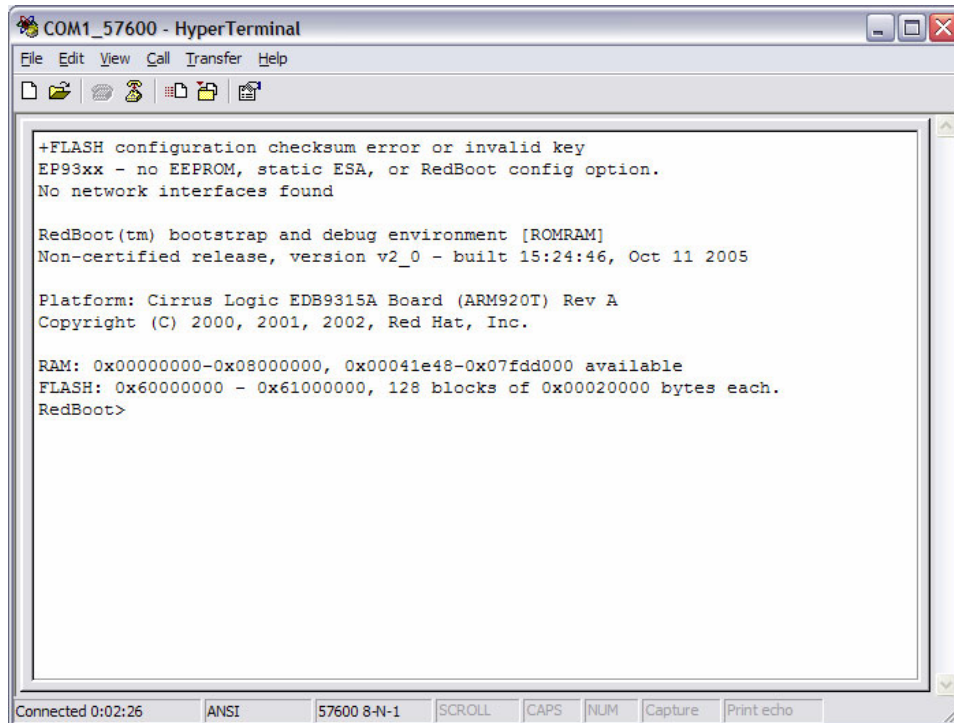

```
COM1_57600 - HyperTerminal
File Edit View Call Transfer Help
+FLASH configuration checksum error or invalid key
EP93xx - no EEPROM, static ESA, or RedBoot config option.
No network interfaces found

RedBoot(tm) bootstrap and debug environment [ROMRAM]
Non-certified release, version v2_0 - built 15:24:46, Oct 11 2005

Platform: Cirrus Logic EDB9315A Board (ARM920I) Rev A
Copyright (C) 2000, 2001, 2002, Red Hat, Inc.

RAM: 0x00000000-0x08000000, 0x00041e48-0x07fdd000 available
FLASH: 0x60000000 - 0x61000000, 128 blocks of 0x00020000 bytes each.
RedBoot>
```

*Note:* The initial error about configuration checksum error is expected for a brand new board or a board where the Flash device has been completely erased. This happens because the Flash memory has not been initialized for redboot yet.

*Note:* Linux is case sensitive, pay close attention to the commands that follow.

*Note:* Steps 5-9 are for new boards only or when putting Linux on the board for the first time or for boards where the Flash device has been completely erased. If you have already configured the board, proceed to step 10.

5. Initialize Flash memory by typing "fis init -f" at the RedBoot> prompt.
6. The next step is to configure the board so it can communicate via Ethernet. Type "fconfig" in the HyperTerminal window and set all parameters like the picture below.

*Note:* You may have to hit the Backspace key to change some parameters and then type in the new parameter.



7. The MAC address label on the top of the board has a hexadecimal number on it. It has the following format: AB1234567890. When programming the MAC address, use the following format: 0xAB:0x12:0x34:0x56:0x78:0x90. This is an example MAC address.

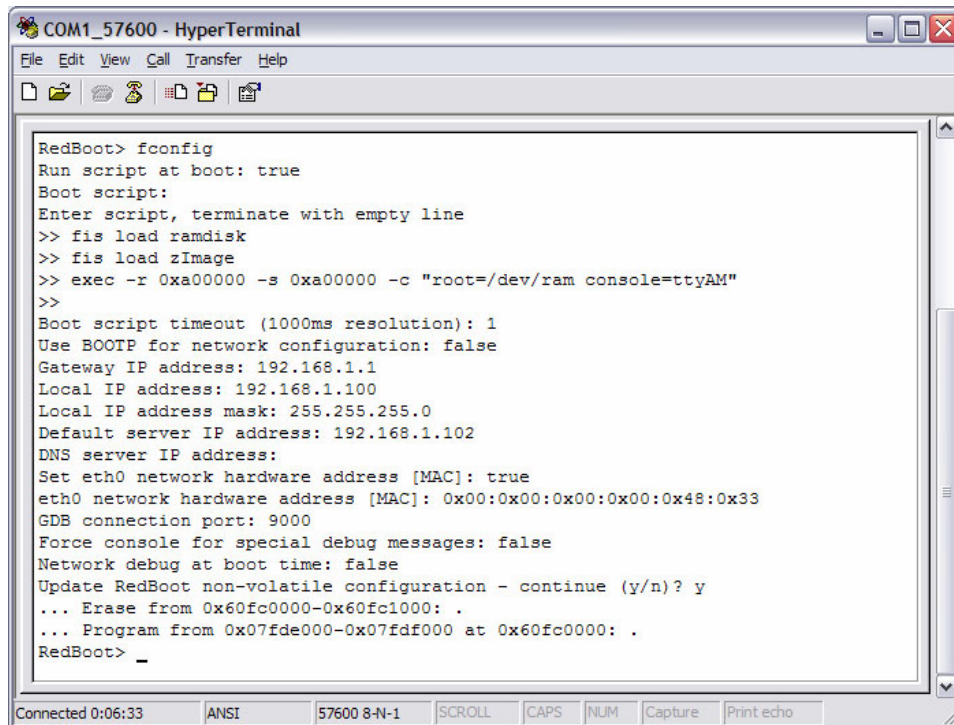

```

COM1_57600 - HyperTerminal
File Edit View Call Transfer Help
[Icons]
RedBoot> fconfig
Run script at boot: true
Boot script:
Enter script, terminate with empty line
>> fis load ramdisk
>> fis load zImage
>> exec -r 0xa00000 -s 0xa00000 -c "root=/dev/ram console=ttyAM"
>>
Boot script timeout (1000ms resolution): 1
Use BOOTP for network configuration: false
Gateway IP address: 192.168.1.1
Local IP address: 192.168.1.100
Local IP address mask: 255.255.255.0
Default server IP address: 192.168.1.102
DNS server IP address:
Set eth0 network hardware address [MAC]: true
eth0 network hardware address [MAC]: 0x00:0x00:0x00:0x48:0x33
GDB connection port: 9000
Force console for special debug messages: false
Network debug at boot time: false
Update RedBoot non-volatile configuration - continue (y/n)? y
... Erase from 0x60fc0000-0x60fc1000: .
... Program from 0x07fde000-0x07fdf000 at 0x60fc0000: .
RedBoot> _
Connected 0:06:33  ANSI  57600 8-N-1  SCROLL  CAPS  NUM  Capture  Print echo
  
```

8. Remember, assign a unique MAC address to each board.
9. Press and release pushbutton S3 "/POR" for the changes to take effect. You should see the following.

*Note: It will say "No image 'image\_name' found". That is ok for now. We have not downloaded and programmed those images into Flash yet*

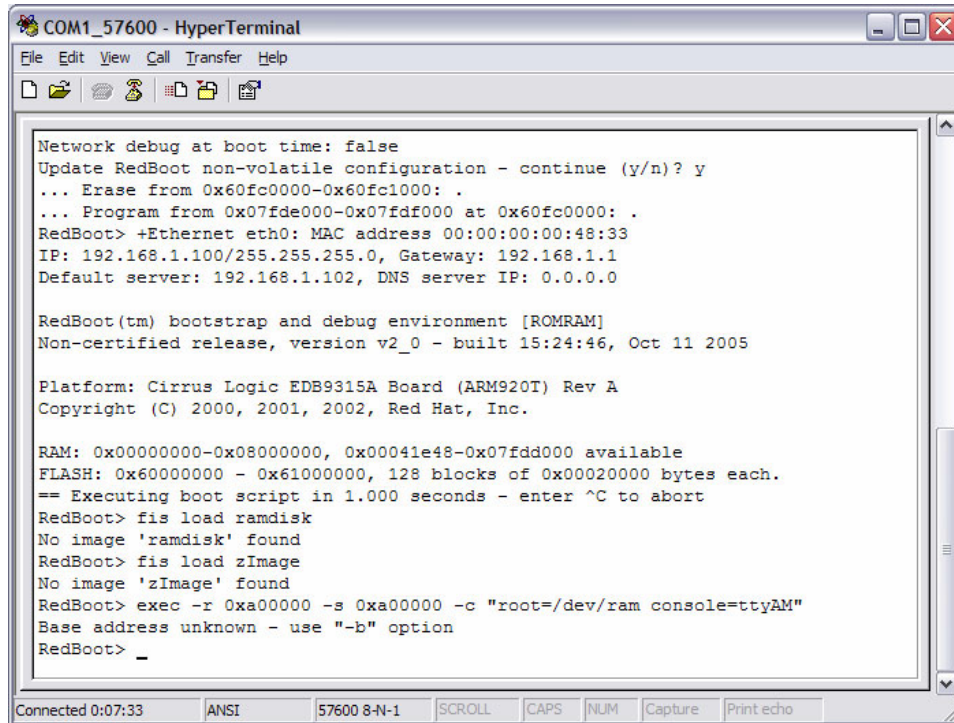

```
COM1_57600 - HyperTerminal
File Edit View Call Transfer Help
Network debug at boot time: false
Update RedBoot non-volatile configuration - continue (y/n)? y
... Erase from 0x60fc0000-0x60fc1000: .
... Program from 0x07fde000-0x07fdf000 at 0x60fc0000: .
RedBoot> +Ethernet eth0: MAC address 00:00:00:00:48:33
IP: 192.168.1.100/255.255.255.0, Gateway: 192.168.1.1
Default server: 192.168.1.102, DNS server IP: 0.0.0.0

RedBoot(tm) bootstrap and debug environment [ROMRAM]
Non-certified release, version v2_0 - built 15:24:46, Oct 11 2005

Platform: Cirrus Logic EDB9315A Board (ARM920T) Rev A
Copyright (C) 2000, 2001, 2002, Red Hat, Inc.

RAM: 0x00000000-0x08000000, 0x00041e48-0x07fdd000 available
FLASH: 0x60000000 - 0x61000000, 128 blocks of 0x00020000 bytes each.
== Executing boot script in 1.000 seconds - enter ^C to abort
RedBoot> fis load ramdisk
No image 'ramdisk' found
RedBoot> fis load zImage
No image 'zImage' found
RedBoot> exec -r 0xa00000 -s 0xa00000 -c "root=/dev/ram console=ttyAM"
Base address unknown - use "-b" option
RedBoot> _

Connected 0:07:33  ANSI  57600 8-N-1  SCROLL  CAPS  NUM  Capture  Print echo
```

10. Execute the following command: `load -v -r -b 0xa00000 ramdisk.gz`
11. You will see a spinning character in the bottom left hand side of the window. Wait until the `RedBoot>` prompt returns.
12. Next type: `fis create -b 0xa00000 -l 0xa00000 ramdisk`
13. This command will program the `ramdisk.gz` file into a Flash partition called `ramdisk`. Wait until the `RedBoot>` prompt returns.
14. Execute the following command: `load -v -r -b 0x80000 zImage`
15. You will see a spinning character in the bottom left hand side of the window. Wait until the `RedBoot>` prompt returns.
16. Next type: `fis create -b 0x80000 -l 0x140000 zImage`
17. This command will program the `zImage` file into a Flash partition called `zImage`. Wait until the `RedBoot>` prompt returns.
18. The software has now been programmed into Flash.

*Note: The image sizes may increase as new features are added. In that case, some of the values in the load and fis create commands may change. The size can be determined from the reported status after the load. Simply subtract the end address from the start address. It is acceptable to make the partition larger than the exact image file size.*

Once the board has been programmed, reset the board and wait for it to boot up. You will see the following (or similar) screen on the display..



## Revision History

Revision	Date	Changes
DB1	DEC 2005	First release.
DB2	AUG 2006	Updated for Rev C PCB. Reference designator S2 changed to S1 (power switch). Rev C board is identified by the revision level printed next to the serial number on the backside of the PCB under the UART0 connector, J2.
DB3	AUG 2006	Corrected schematic page numbering - schematic page 9.

---

## Contacting Cirrus Logic Support

For all product questions and inquiries contact a Cirrus Logic Sales Representative. To find the one nearest to you go to [www.cirrus.com](http://www.cirrus.com).

---

### IMPORTANT NOTICE

Cirrus Logic, Inc. and its subsidiaries ("Cirrus") believe that the information contained in this document is accurate and reliable. However, the information is subject to change without notice and is provided "AS IS" without warranty of any kind (express or implied). Customers are advised to obtain the latest version of relevant information to verify, before placing orders, that information being relied on is current and complete. All products are sold subject to the terms and conditions of sale supplied at the time of order acknowledgment, including those pertaining to warranty, indemnification, and limitation of liability. No responsibility is assumed by Cirrus for the use of this information, including use of this information as the basis for manufacture or sale of any items, or for infringement of patents or other rights of third parties. This document is the property of Cirrus and by furnishing this information, Cirrus grants no license, express or implied under any patents, mask work rights, copyrights, trademarks, trade secrets or other intellectual property rights. Cirrus owns the copyrights associated with the information contained herein and gives consent for copies to be made of the information only for use within your organization with respect to Cirrus integrated circuits or other products of Cirrus. This consent does not extend to other copying such as copying for general distribution, advertising or promotional purposes, or for creating any work for resale.

CERTAIN APPLICATIONS USING SEMICONDUCTOR PRODUCTS MAY INVOLVE POTENTIAL RISKS OF DEATH, PERSONAL INJURY, OR SEVERE PROPERTY OR ENVIRONMENTAL DAMAGE ("CRITICAL APPLICATIONS"). CIRRUS PRODUCTS ARE NOT DESIGNED, AUTHORIZED OR WARRANTED FOR USE IN AIRCRAFT SYSTEMS, MILITARY APPLICATIONS, PRODUCTS SURGICALLY IMPLANTED INTO THE BODY, AUTOMOTIVE SAFETY OR SECURITY DEVICES, LIFE SUPPORT PRODUCTS OR OTHER CRITICAL APPLICATIONS. INCLUSION OF CIRRUS PRODUCTS IN SUCH APPLICATIONS IS UNDERSTOOD TO BE FULLY AT THE CUSTOMER'S RISK AND CIRRUS DISCLAIMS AND MAKES NO WARRANTY, EXPRESS, STATUTORY OR IMPLIED, INCLUDING THE IMPLIED WARRANTIES OF MERCHANTABILITY AND FITNESS FOR PARTICULAR PURPOSE, WITH REGARD TO ANY CIRRUS PRODUCT THAT IS USED IN SUCH A MANNER. IF THE CUSTOMER OR CUSTOMER'S CUSTOMER USES OR PERMITS THE USE OF CIRRUS PRODUCTS IN CRITICAL APPLICATIONS, CUSTOMER AGREES, BY SUCH USE, TO FULLY INDEMNIFY CIRRUS, ITS OFFICERS, DIRECTORS, EMPLOYEES, DISTRIBUTORS AND OTHER AGENTS FROM ANY AND ALL LIABILITY, INCLUDING ATTORNEYS' FEES AND COSTS, THAT MAY RESULT FROM OR ARISE IN CONNECTION WITH THESE USES.

Cirrus Logic, Cirrus, and the Cirrus Logic logo designs are trademarks of Cirrus Logic, Inc. All other brand and product names in this document may be trademarks or service marks of their respective owners.

ARM, ARM9, RealView, and Multi-ICE are trademarks or registered trademarks of ARM Limited.

IAR is a trademark of IAR Syatem.

Windows, Windows XP, Windows 2000, and WinCE are registered trademarks of Microsoft Corporation.

Platform Builder is a trademark of Microsoft Corporation.

SPI is a trademark of Motorola, Inc..

Linux is a registered trademark of Linus Torvalds.

Red Hat is a registered trademark of Red Hat, Inc.

PADS is a trademark of Mentor Graphics Corporation.

OrCAD is a trademark of Cadence Design Systems, Inc.

Pentium is a registered trademark of Intel Corporation.