

# RF Power LDMOS Transistors

## N-Channel Enhancement-Mode Lateral MOSFETs

These 56 W RF power LDMOS transistors are designed for cellular base station applications requiring very wide instantaneous bandwidth capability covering the frequency range of 716 to 960 MHz.

### 900 MHz

- Typical Single-Carrier W-CDMA Performance:  $V_{DD} = 28$  Vdc,  $I_{DQ} = 1400$  mA,  $P_{out} = 56$  W Avg., Input Signal PAR = 9.9 dB @ 0.01% Probability on CCDF.

Frequency	$G_{ps}$ (dB)	$\eta_D$ (%)	Output PAR (dB)	ACPR (dBc)	IRL (dB)
920 MHz	19.2	34.0	6.9	-35.7	-25
940 MHz	19.3	35.1	7.0	-36.0	-20
960 MHz	19.2	36.5	6.8	-34.8	-13

### 700 MHz

- Typical Single-Carrier W-CDMA Performance:  $V_{DD} = 28$  Vdc,  $I_{DQ} = 1400$  mA,  $P_{out} = 56$  W Avg., Input Signal PAR = 9.9 dB @ 0.01% Probability on CCDF.

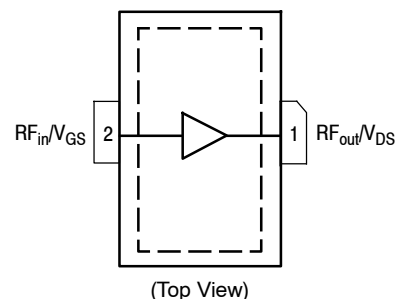
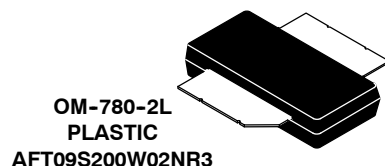
Frequency	$G_{ps}$ (dB)	$\eta_D$ (%)	Output PAR (dB)	ACPR (dBc)	IRL (dB)
716 MHz	22.7	37.5	6.9	-34.7	-18
722 MHz	22.6	37.2	6.9	-34.6	-19
728 MHz	22.5	36.9	6.9	-34.6	-18

### Features

- Designed for Wide Instantaneous Bandwidth Applications
- Greater Negative Gate-Source Voltage Range for Improved Class C Operation
- Able to Withstand Extremely High Output VSWR and Broadband Operating Conditions
- Optimized for Doherty Applications
- In Tape and Reel. R3 Suffix = 250 Units, 32 mm Tape Width, 13-inch Reel.

**AFT09S200W02NR3**  
**AFT09S200W02GNR3**

**716–960 MHz, 56 W AVG., 28 V**  
**AIRFAST RF POWER LDMOS**  
**TRANSISTORS**



Note: Exposed backside of the package is the source terminal for the transistor.

**Figure 1. Pin Connections**

**Table 1. Maximum Ratings**

Rating	Symbol	Value	Unit
Drain-Source Voltage	$V_{DSS}$	-0.5, +70	Vdc
Gate-Source Voltage	$V_{GS}$	-6.0, +10	Vdc
Operating Voltage	$V_{DD}$	32, +0	Vdc
Storage Temperature Range	$T_{stg}$	-65 to +150	°C
Case Operating Temperature Range	$T_C$	-40 to +125	°C
Operating Junction Temperature Range (1,2)	$T_J$	-40 to +225	°C

**Table 2. Thermal Characteristics**

Characteristic	Symbol	Value (2,3)	Unit
Thermal Resistance, Junction to Case Case Temperature 80°C, 56 W CW, 28 Vdc, $I_{DQ} = 1400$ mA, 940 MHz	$R_{\theta JC}$	0.35	°C/W

**Table 3. ESD Protection Characteristics**

Test Methodology	Class
Human Body Model (per JESD22-A114)	2
Machine Model (per EIA/JESD22-A115)	B
Charge Device Model (per JESD22-C101)	IV

**Table 4. Moisture Sensitivity Level**

Test Methodology	Rating	Package Peak Temperature	Unit
Per JESD22-A113, IPC/JEDEC J-STD-020	3	260	°C

**Table 5. Electrical Characteristics** ( $T_A = 25^\circ\text{C}$  unless otherwise noted)

Characteristic	Symbol	Min	Typ	Max	Unit
----------------	--------	-----	-----	-----	------

**Off Characteristics**

Zero Gate Voltage Drain Leakage Current ( $V_{DS} = 70$ Vdc, $V_{GS} = 0$ Vdc)	$I_{DSS}$	—	—	10	$\mu\text{Adc}$
Zero Gate Voltage Drain Leakage Current ( $V_{DS} = 28$ Vdc, $V_{GS} = 0$ Vdc)	$I_{DSS}$	—	—	5	$\mu\text{Adc}$
Gate-Source Leakage Current ( $V_{GS} = 5$ Vdc, $V_{DS} = 0$ Vdc)	$I_{GSS}$	—	—	1	$\mu\text{Adc}$

**On Characteristics**

Gate Threshold Voltage ( $V_{DS} = 10$ Vdc, $I_D = 729$ $\mu\text{Adc}$ )	$V_{GS(th)}$	1.0	1.5	2.0	Vdc
Gate Quiescent Voltage ( $V_{DS} = 28$ Vdc, $I_D = 1400$ mA)	$V_{GS(Q)}$	—	2.15	—	Vdc
Fixture Gate Quiescent Voltage <sup>(4)</sup> ( $V_{DD} = 28$ Vdc, $I_D = 1400$ mA, Measured in Functional Test)	$V_{GG(Q)}$	3.2	4.3	5.2	Vdc
Drain-Source On-Voltage ( $V_{GS} = 10$ Vdc, $I_D = 4.1$ Adc)	$V_{DS(on)}$	0.1	0.2	0.3	Vdc

1. Continuous use at maximum temperature will affect MTTF.
2. MTTF calculator available at <http://www.freescale.com/rf>. Select Software & Tools/Development Tools/Calculators to access MTTF calculators by product.
3. Refer to AN1955, *Thermal Measurement Methodology of RF Power Amplifiers*. Go to <http://www.freescale.com/rf>. Select Documentation/Application Notes - AN1955.
4.  $V_{GG} = 2.0 \times V_{GS(Q)}$ . Parameter measured on Freescale Test Fixture, due to resistor divider network on the board. Refer to Test Fixture Layout.

(continued)

**Table 5. Electrical Characteristics** ( $T_A = 25^\circ\text{C}$  unless otherwise noted) (continued)

Characteristic	Symbol	Min	Typ	Max	Unit
<b>Functional Tests</b> (1,2) (In Freescale Test Fixture, 50 ohm system) $V_{DD} = 28\text{ Vdc}$ , $I_{DQ} = 1400\text{ mA}$ , $P_{out} = 56\text{ W Avg.}$ , $f = 960\text{ MHz}$ , Single-Carrier W-CDMA, IQ Magnitude Clipping, Input Signal PAR = 9.9 dB @ 0.01% Probability on CCDF. ACPR measured in 3.84 MHz Channel Bandwidth @ $\pm 5\text{ MHz}$ Offset.					
Power Gain	$G_{ps}$	18.5	19.2	21.5	dB
Drain Efficiency	$\eta_D$	32.5	36.5	—	%
Output Peak-to-Average Ratio @ 0.01% Probability on CCDF	PAR	6.5	6.8	—	dB
Adjacent Channel Power Ratio	ACPR	—	-34.8	-33.5	dBc
Input Return Loss	IRL	—	-13	-9	dB

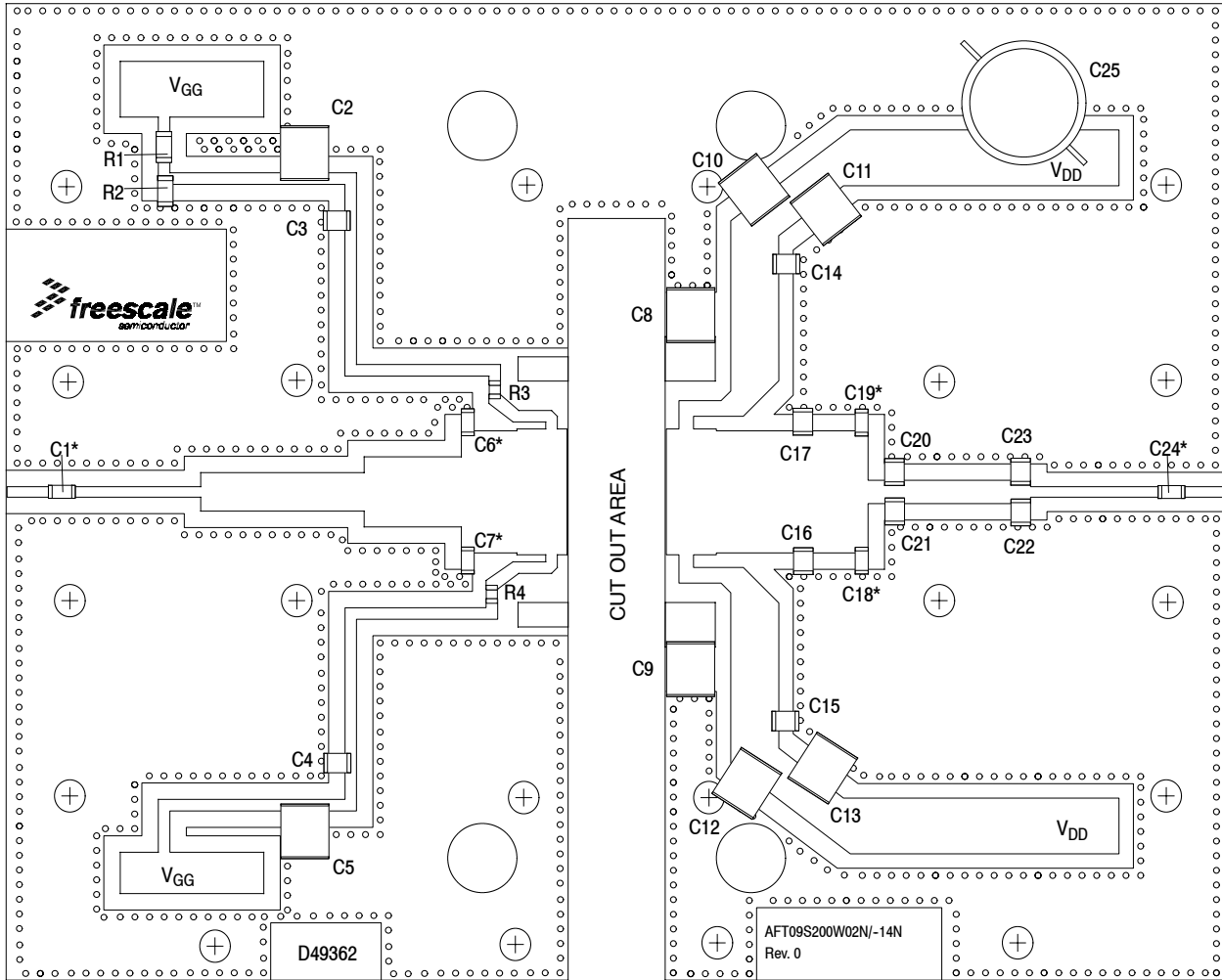
**Load Mismatch** (In Freescale Test Fixture, 50 ohm system)  $I_{DQ} = 1400\text{ mA}$ ,  $f = 940\text{ MHz}$ 

VSWR 10:1 at 32 Vdc, 260 W CW Output Power (3 dB Input Overdrive from 180 W CW Rated Power)	No Device Degradation
--	-----------------------

**Typical Performance** (In Freescale Test Fixture, 50 ohm system)  $V_{DD} = 28\text{ Vdc}$ ,  $I_{DQ} = 1400\text{ mA}$ , 920–960 MHz Bandwidth

$P_{out}$ @ 1 dB Compression Point, CW	P1dB	—	200	—	W
AM/PM (Maximum value measured at the P3dB compression point across the 920–960 MHz frequency range)	$\Phi$	—	-11.5	—	°
VBW Resonance Point (IMD Third Order Intermodulation Inflection Point)	$VBW_{res}$	—	140	—	MHz
Gain Flatness in 40 MHz Bandwidth @ $P_{out} = 56\text{ W Avg.}$	$G_F$	—	0.1	—	dB
Gain Variation over Temperature ( $-30^\circ\text{C}$ to $+85^\circ\text{C}$ )	$\Delta G$	—	0.018	—	dB/°C
Output Power Variation over Temperature ( $-30^\circ\text{C}$ to $+85^\circ\text{C}$ )	$\Delta P1dB$	—	0.004	—	dB/°C

- Part internally matched both on input and output.
- Measurement made with device in straight lead configuration before any lead forming operation is applied. Lead forming is used for gull wing (GN) parts.



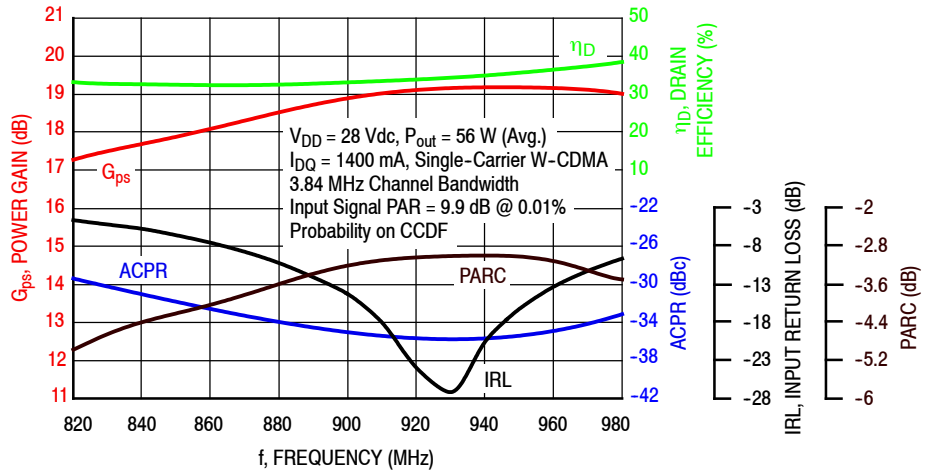
\*C1, C6, C7, C18, C19 and C24 are mounted vertically.

**Figure 2. AFT09S200W02NR3 Test Circuit Component Layout — 920–960 MHz**

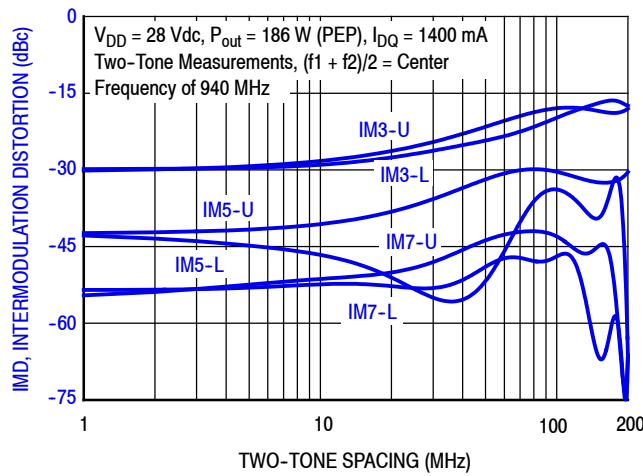
**Table 6. AFT09S200W02NR3 Test Circuit Component Designations and Values — 920–960 MHz**

Part	Description	Part Number	Manufacturer
C1, C3, C4, C14, C15, C24	47 pF Chip Capacitors	ATC100B470JT500XT	ATC
C2, C5, C8, C9, C10, C11, C12, C13	10 $\mu$ F Chip Capacitors	C5750X7S2A106M230KB	TDK
C6, C7	2.7 pF Chip Capacitors	ATC100B2R7BT500XT	ATC
C16, C17	5.6 pF Chip Capacitors	ATC100B5R6CT500XT	ATC
C18, C19	2.0 pF Chip Capacitors	ATC100B2R0BT500XT	ATC
C20, C21	1.0 pF Chip Capacitors	ATC100B1R0BT500XT	ATC
C22, C23	0.3 pF Chip Capacitors	ATC100B0R3BT500XT	ATC
C25	220 $\mu$ F, 100 V Electrolytic Capacitor	EEV-FK2A221M	Panasonic-ECG
R1, R2	1000 $\Omega$ , 1/4 W Chip Resistors	CRCW12061K00FKEA	Vishay
R3, R4	10 $\Omega$ , 1/8 W Chip Resistors	RK73H2ATTD10R0F	KOA Speer
PCB	Rogers RO4350B, 0.020", $\epsilon_r = 3.66$	D49362	MTL

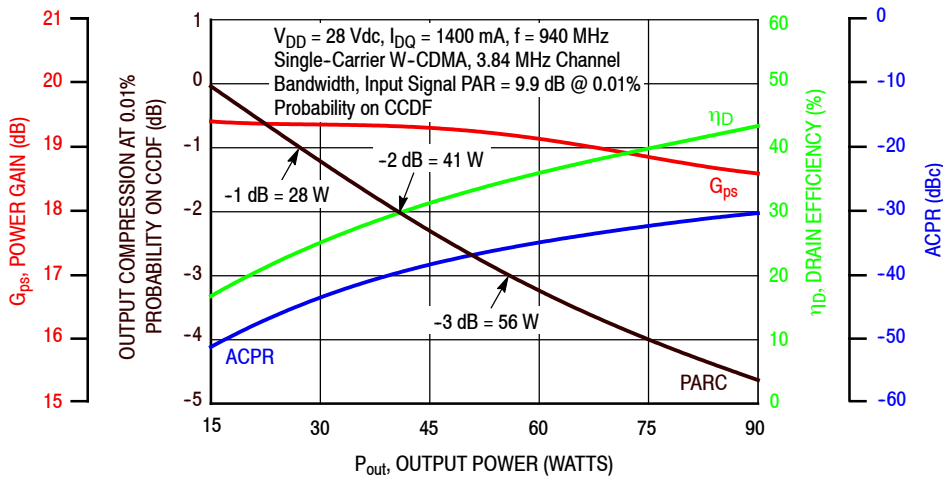
### TYPICAL CHARACTERISTICS — 920–960 MHz



**Figure 3. Single-Carrier Output Peak-to-Average Ratio Compression (PARC) Broadband Performance @  $P_{out} = 56$  Watts Avg.**

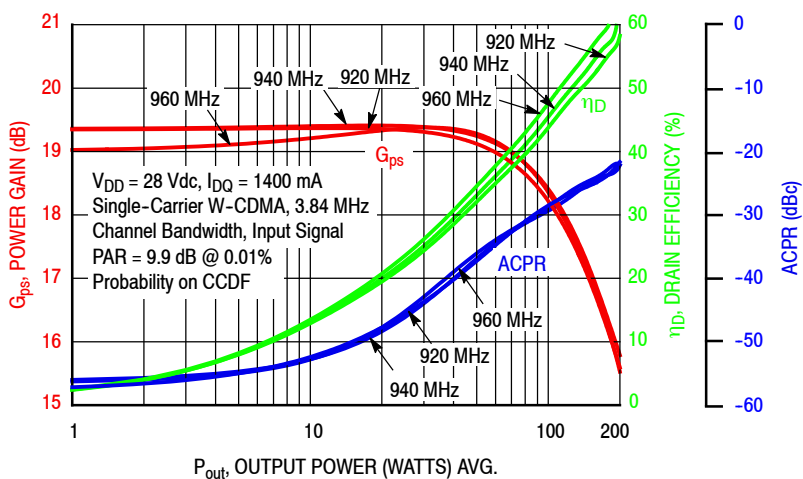


**Figure 4. Intermodulation Distortion Products versus Two-Tone Spacing**

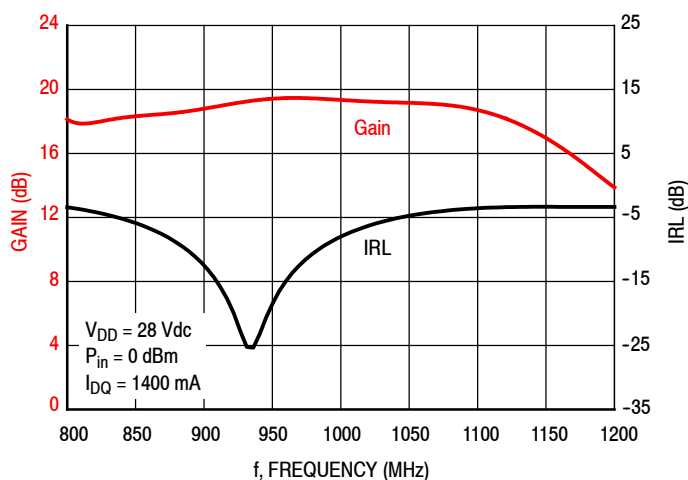


**Figure 5. Output Peak-to-Average Ratio Compression (PARC) versus Output Power**

### TYPICAL CHARACTERISTICS — 920–960 MHz



**Figure 6. Single-Carrier W-CDMA Power Gain, Drain Efficiency and ACPR versus Output Power**



**Figure 7. Broadband Frequency Response**

$V_{DD} = 28 \text{ Vdc}$ ,  $I_{DQ} = 1484 \text{ mA}$ , Pulsed CW, 10  $\mu\text{sec(ON)}$ , 10% Duty Cycle

f (MHz)	$Z_{\text{source}} (\Omega)$	$Z_{\text{in}} (\Omega)$	Max Output Power					
			P1dB					
			$Z_{\text{load}}^{(1)} (\Omega)$	Gain (dB)	(dBm)	(W)	$\eta_D$ (%)	AM/PM (°)
920	1.94 - j4.69	2.09 + j4.54	0.625 - j0.97	17.7	54.0	253	51.4	-6
940	2.29 - j5.04	2.41 + j4.89	0.611 - j1.00	17.4	53.9	245	49.2	-6
960	2.98 - j5.40	2.82 + j5.25	0.653 - j1.12	17.2	53.8	239	49.0	-6

f (MHz)	$Z_{\text{source}} (\Omega)$	$Z_{\text{in}} (\Omega)$	Max Output Power					
			P3dB					
			$Z_{\text{load}}^{(2)} (\Omega)$	Gain (dB)	(dBm)	(W)	$\eta_D$ (%)	AM/PM (°)
920	1.94 - j4.69	2.09 + j4.64	0.566 - j1.00	15.3	55.2	333	53.8	-9
940	2.29 - j5.04	2.43 + j4.99	0.564 - j1.06	15.0	55.1	325	52.5	-9
960	2.98 - j5.40	2.83 + j5.37	0.578 - j1.11	14.8	55.0	318	52.0	-8

(1) Load impedance for optimum P1dB power.

(2) Load impedance for optimum P3dB power.

$Z_{\text{source}}$  = Measured impedance presented to the input of the device at the package reference plane.

$Z_{\text{in}}$  = Impedance as measured from gate contact to ground.

$Z_{\text{load}}$  = Measured impedance presented to the output of the device at the package reference plane.

**Figure 8. Load Pull Performance — Maximum Power Tuning**

$V_{DD} = 28 \text{ Vdc}$ ,  $I_{DQ} = 1484 \text{ mA}$ , Pulsed CW, 10  $\mu\text{sec(ON)}$ , 10% Duty Cycle

f (MHz)	$Z_{\text{source}} (\Omega)$	$Z_{\text{in}} (\Omega)$	Max Drain Efficiency					
			P1dB					
			$Z_{\text{load}}^{(1)} (\Omega)$	Gain (dB)	(dBm)	(W)	$\eta_D$ (%)	AM/PM (°)
920	1.94 - j4.69	2.10 + j4.65	1.36 - j0.05	21.1	51.6	144	65.6	-12
940	2.29 - j5.04	2.45 + j4.99	1.33 - j0.14	20.8	51.6	145	63.6	-11
960	2.98 - j5.40	2.87 + j5.33	1.30 - j0.35	20.2	51.9	154	62.5	-10

f (MHz)	$Z_{\text{source}} (\Omega)$	$Z_{\text{in}} (\Omega)$	Max Drain Efficiency					
			P3dB					
			$Z_{\text{load}}^{(2)} (\Omega)$	Gain (dB)	(dBm)	(W)	$\eta_D$ (%)	AM/PM (°)
920	1.94 - j4.69	2.12 + j4.72	1.34 - j0.18	18.9	52.8	191	68.6	-17
940	2.29 - j5.04	2.47 + j5.10	1.30 - j0.13	18.8	52.5	179	67.1	-17
960	2.98 - j5.40	2.89 + j5.44	1.27 - j0.35	18.2	52.8	191	65.6	-15

(1) Load impedance for optimum P1dB efficiency.

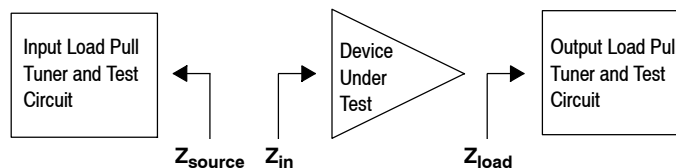
(2) Load impedance for optimum P3dB efficiency.

$Z_{\text{source}}$  = Measured impedance presented to the input of the device at the package reference plane.

$Z_{\text{in}}$  = Impedance as measured from gate contact to ground.

$Z_{\text{load}}$  = Measured impedance presented to the output of the device at the package reference plane.

**Figure 9. Load Pull Performance — Maximum Drain Efficiency Tuning**



### P1dB - TYPICAL LOAD PULL CONTOURS — 940 MHz

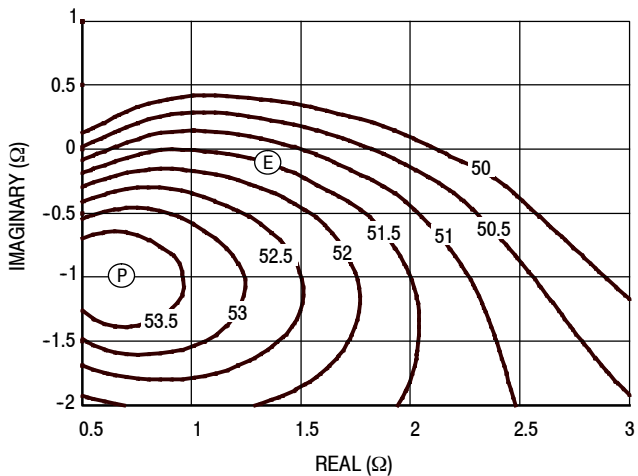


Figure 10. P1dB Load Pull Output Power Contours (dBm)

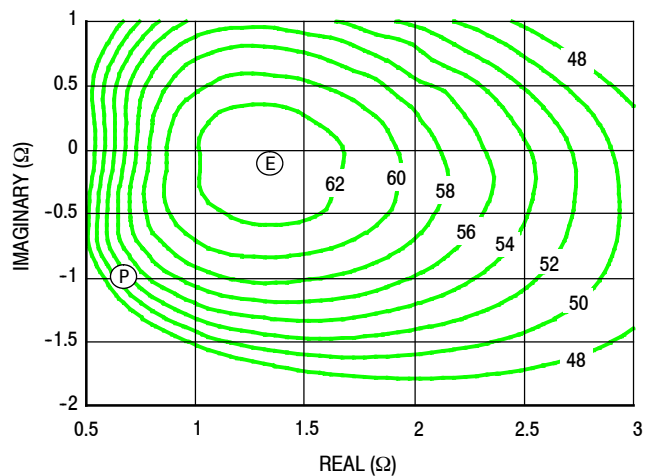


Figure 11. P1dB Load Pull Efficiency Contours (%)

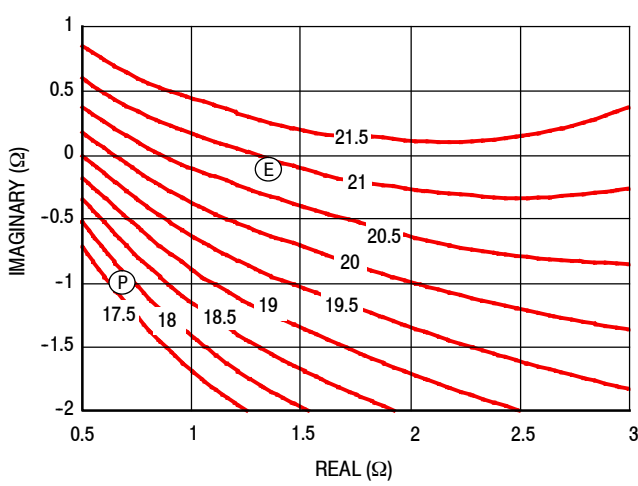


Figure 12. P1dB Load Pull Gain Contours (dB)

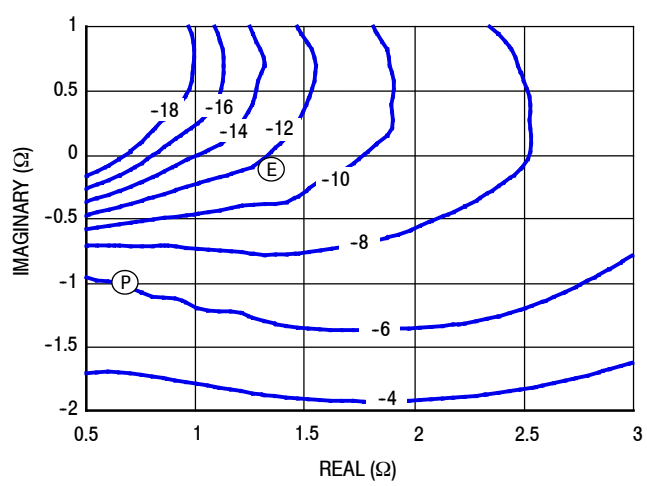


Figure 13. P1dB Load Pull AM/PM Contours (°)

**NOTE:** (P) = Maximum Output Power  
 (E) = Maximum Drain Efficiency

- Gain
- Drain Efficiency
- Linearity
- Output Power



### P3dB - TYPICAL LOAD PULL CONTOURS — 940 MHz

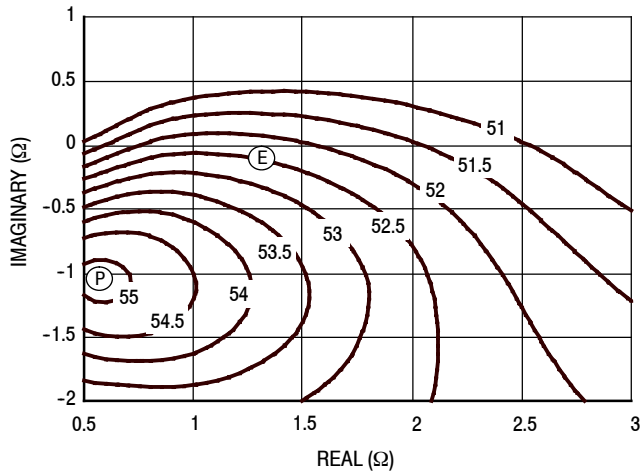


Figure 14. P3dB Load Pull Output Power Contours (dBm)

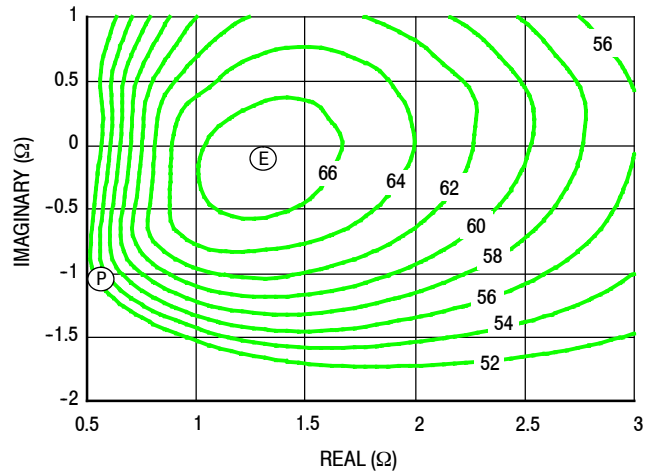


Figure 15. P3dB Load Pull Efficiency Contours (%)

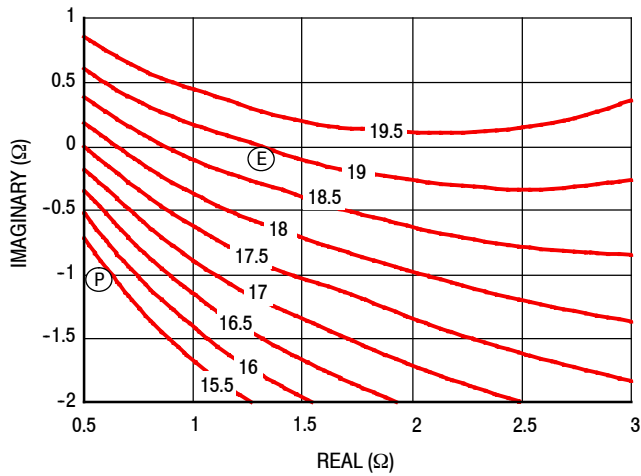


Figure 16. P3dB Load Pull Gain Contours (dB)

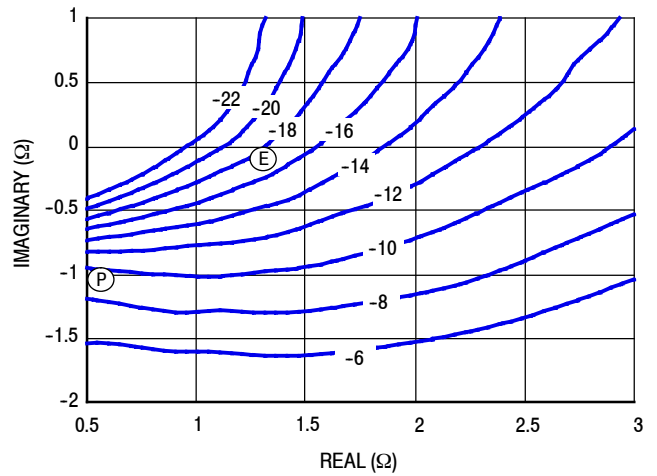
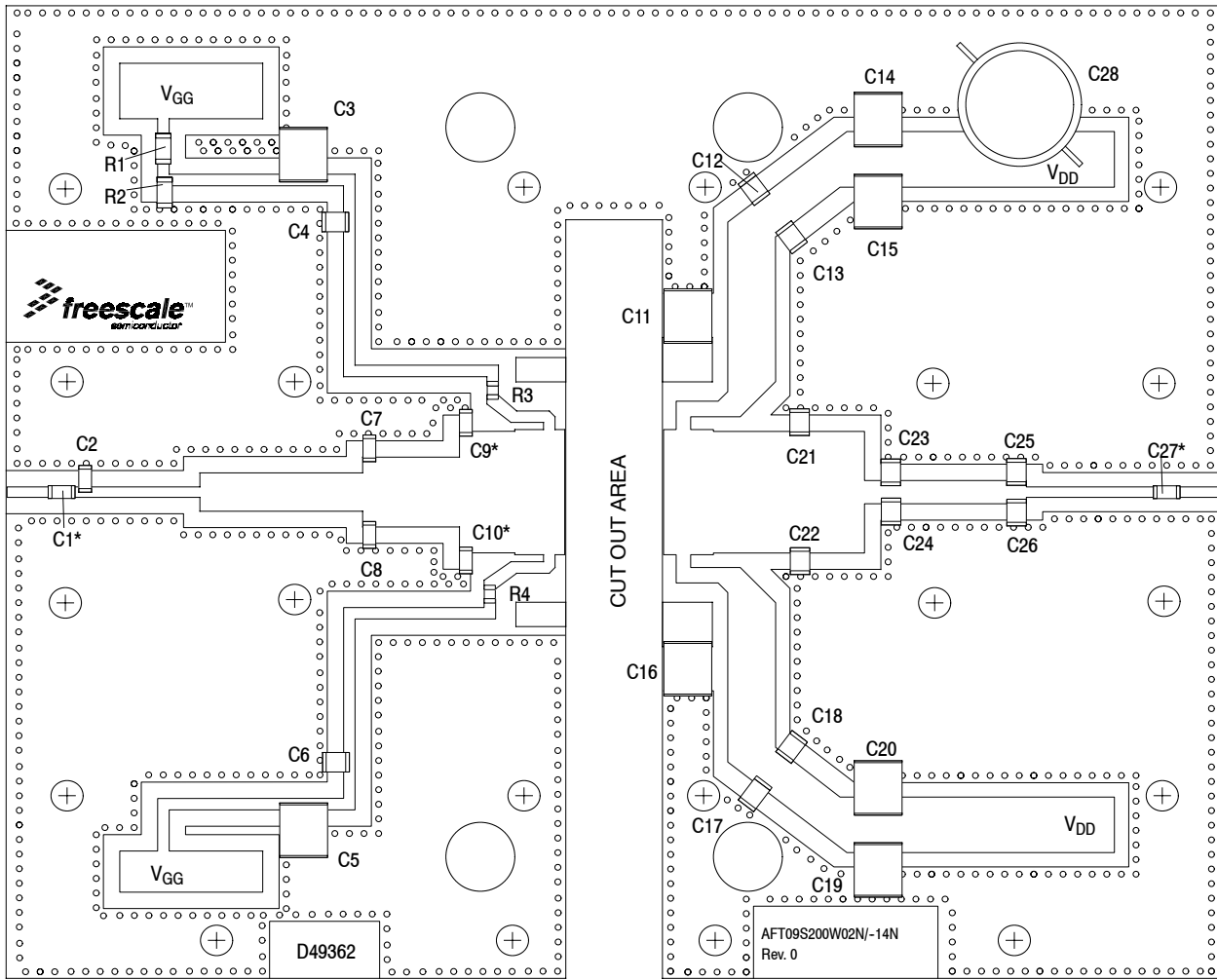


Figure 17. P3dB Load Pull AM/PM Contours (°)

**NOTE:** (P) = Maximum Output Power  
(E) = Maximum Drain Efficiency

- Gain
- Drain Efficiency
- Linearity
- Output Power

## ALTERNATIVE CHARACTERIZATION — 716–728 MHz



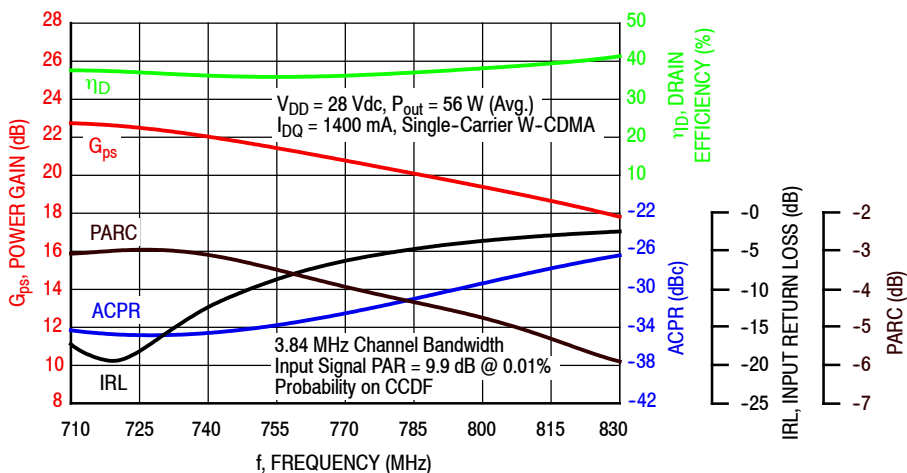
\*C1, C9, C10, and C27 are mounted vertically.

**Figure 18. AFT09S200W02NR3 Test Circuit Component Layout — 716–728 MHz**

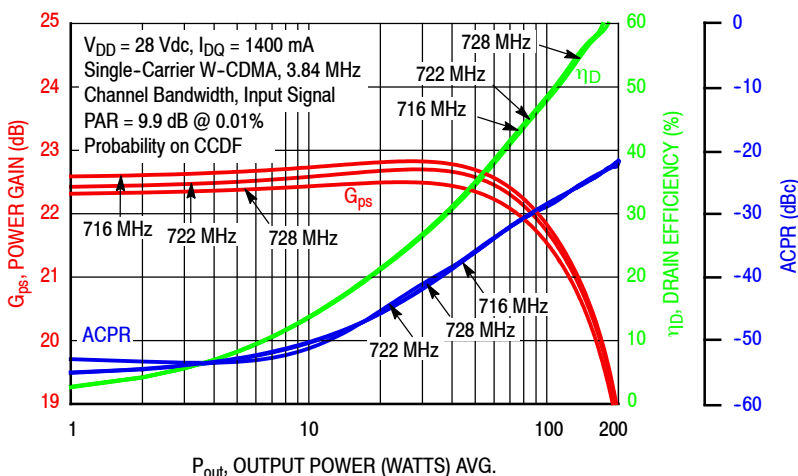
**Table 7. AFT09S200W02NR3 Test Circuit Component Designations and Values — 716–728 MHz**

Part	Description	Part Number	Manufacturer
C1, C4, C6, C12, C13, C17, C18, C27	68 pF Chip Capacitors	ATC100B680JT500XT	ATC
C2	1.1 pF Chip Capacitor	ATC100B1R1BT500XT	ATC
C3, C5, C11, C14, C15, C16, C19, C20	15 $\mu$ F Chip Capacitors	C5750X7S2A156M250KB	TDK
C7, C8, C21, C22	5.1 pF Chip Capacitors	ATC100B5R1CT500XT	ATC
C9, C10	9.1 pF Chip Capacitors	ATC100B9R1CT500XT	ATC
C23, C24	6.8 pF Chip Capacitors	ATC100B6R8CT500XT	ATC
C25, C26	1.7 pF Chip Capacitors	ATC100B1R7BT500XT	ATC
C28	220 $\mu$ F, 100 V Electrolytic Capacitor	EEV-FK2A221M	Panasonic-ECG
R1, R2	1000 $\Omega$ , 1/4 W Chip Resistors	CRCW12061K00FKEA	Vishay
R3, R4	10 $\Omega$ , 1/8 W Chip Resistors	RK73H2ATTD10R0F	KOA Speer
PCB	Rogers RO4350B, 0.020", $\epsilon_r = 3.66$	D49362	MTL

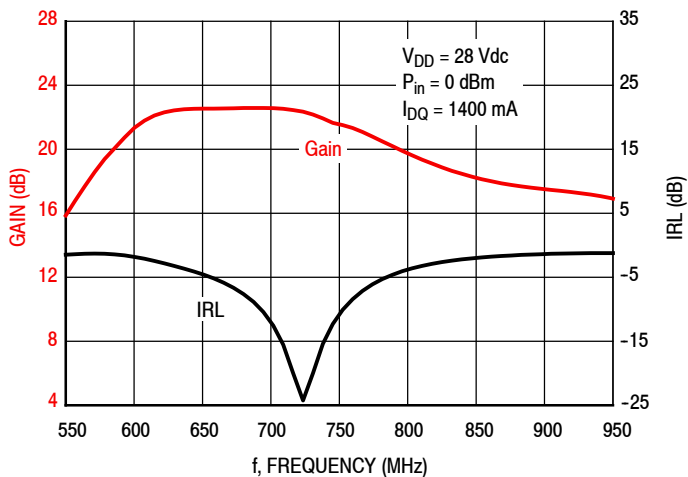
### ALTERNATIVE CHARACTERIZATION—716–728 MHz



**Figure 19. Single-Carrier Output Peak-to-Average Ratio Compression (PARC) Broadband Performance @  $P_{out} = 56$  Watts Avg.**

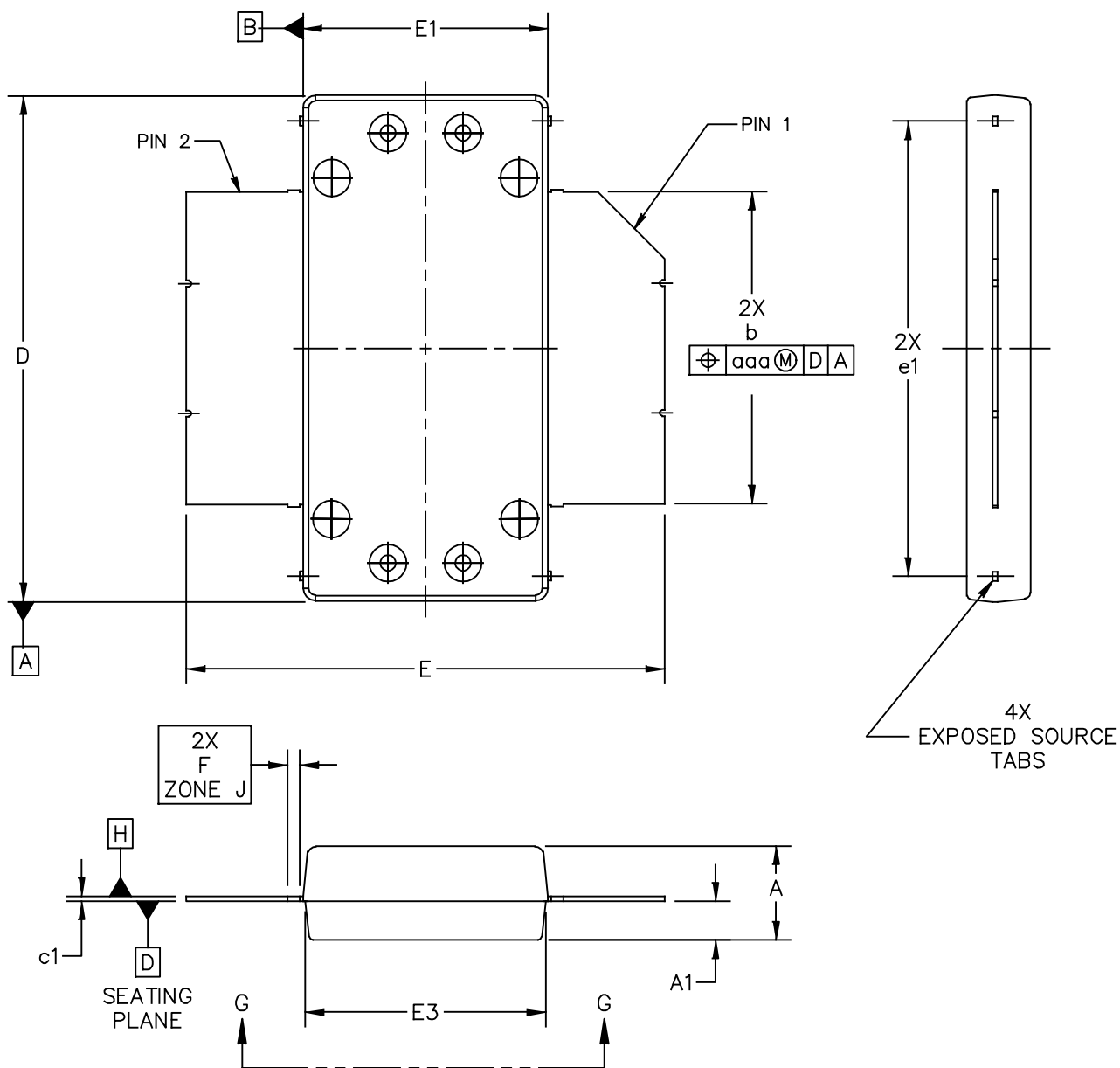


**Figure 20. Single-Carrier W-CDMA Power Gain, Drain Efficiency and ACPR versus Output Power**

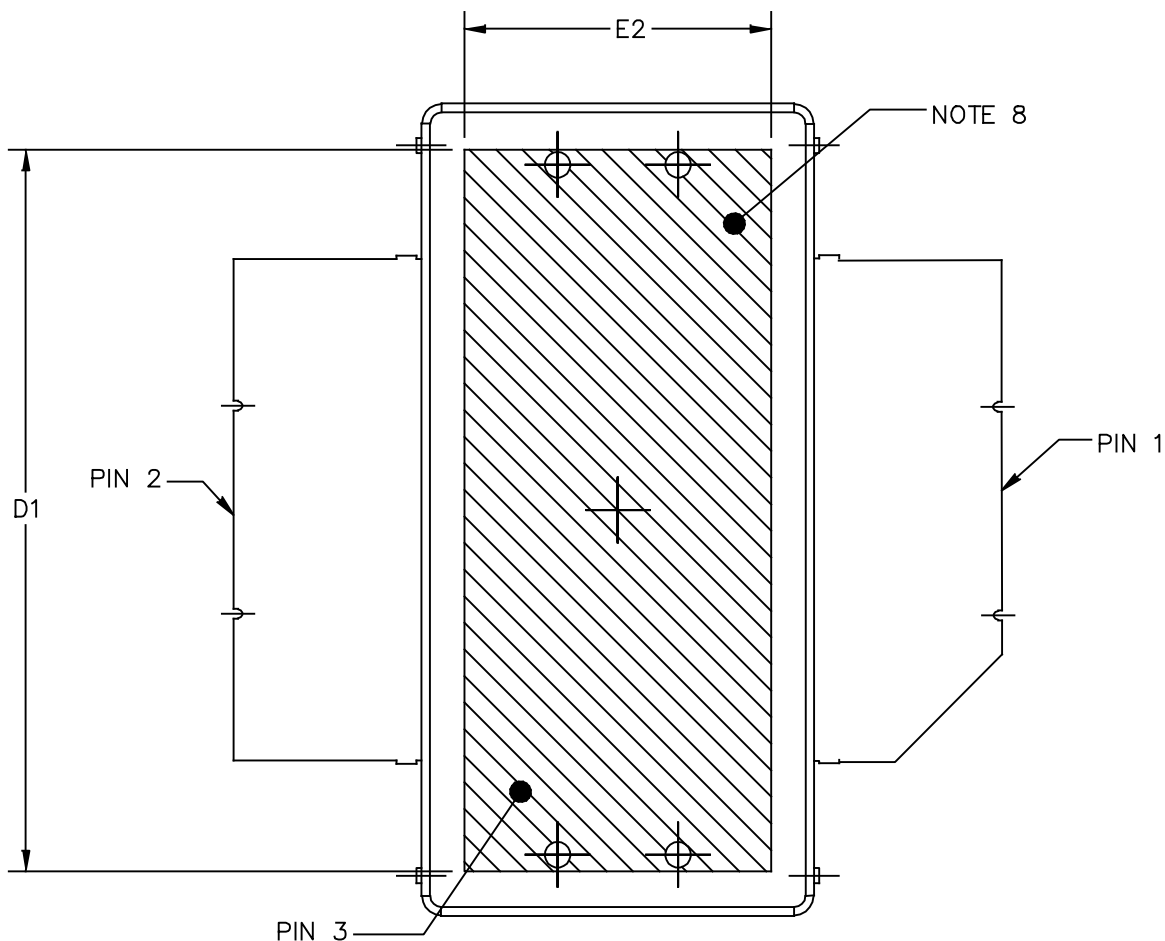


**Figure 21. Broadband Frequency Response**

### PACKAGE DIMENSIONS



© FREESCALE SEMICONDUCTOR, INC. ALL RIGHTS RESERVED.	MECHANICAL OUTLINE	PRINT VERSION NOT TO SCALE
TITLE: <b>OM780-2 STRAIGHT LEAD</b>	DOCUMENT NO: 98ASA10831D	REV: B
	CASE NUMBER: 2021-03	22 OCT 2009
	STANDARD: NON-JEDEC	



BOTTOM VIEW  
VIEW G-G

© FREESCALE SEMICONDUCTOR, INC. ALL RIGHTS RESERVED.	MECHANICAL OUTLINE	PRINT VERSION NOT TO SCALE	
TITLE: OM780-2 STRAIGHT LEAD	DOCUMENT NO: 98ASA10831D	REV: B	
	CASE NUMBER: 2021-03	22 OCT 2009	
	STANDARD: NON-JEDEC		

NOTES:

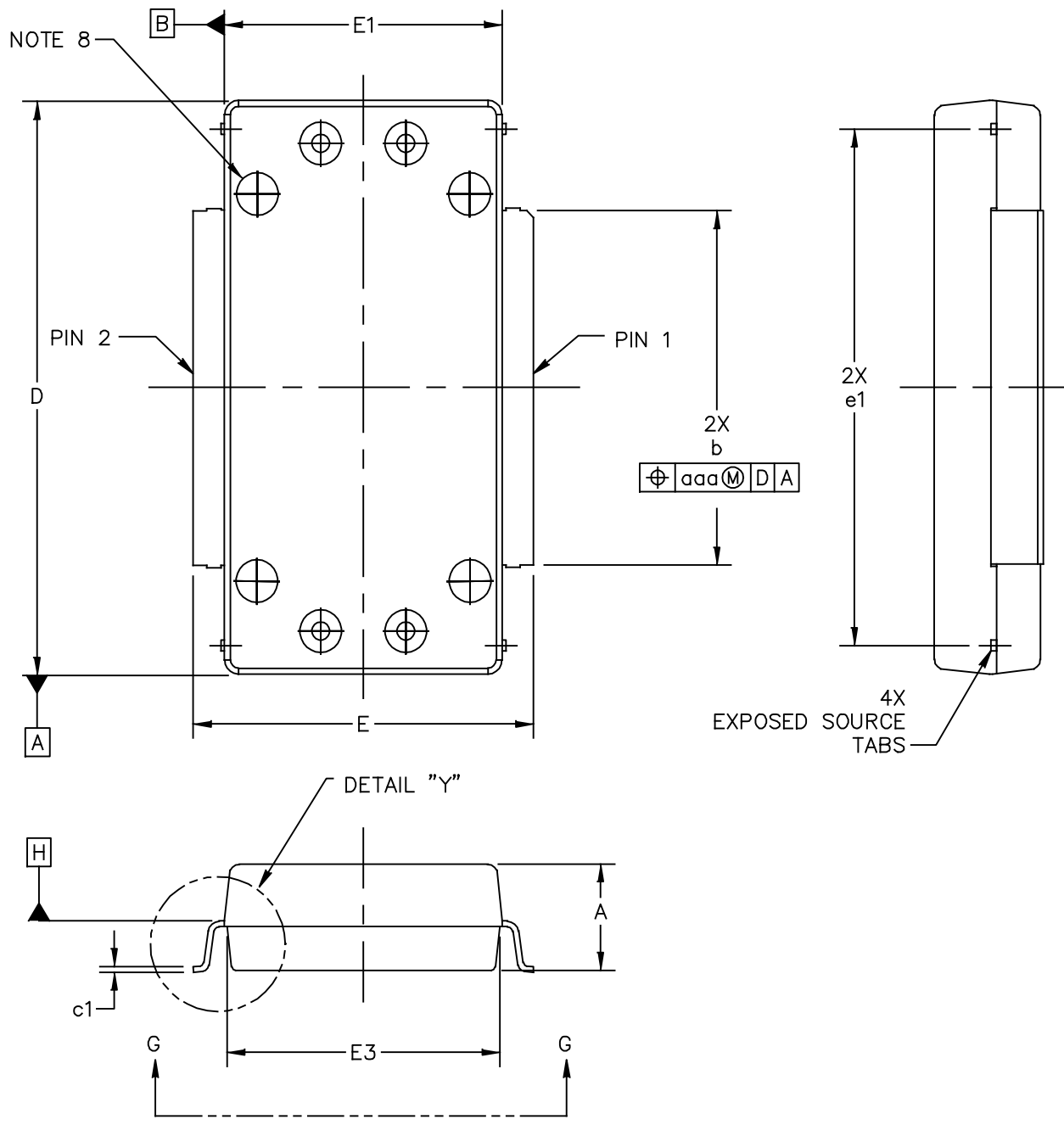
1. CONTROLLING DIMENSION: INCH
2. INTERPRET DIMENSIONS AND TOLERANCES PER ASME Y14.5M-1994.
3. DATUM PLANE -H- IS LOCATED AT TOP OF LEAD AND IS COINCIDENT WITH THE LEAD WHERE THE LEAD EXITS THE PLASTIC BODY AT THE TOP OF THE PARTING LINE.
4. DIMENSIONS "D" AND "E1" DO NOT INCLUDE MOLD PROTRUSION. ALLOWABLE PROTRUSION IS .006 PER SIDE. DIMENSIONS "D AND "E1" DO INCLUDE MOLD MISMATCH AND ARE DETERMINED AT DATUM PLANE -H-.
5. DIMENSION b DOES NOT INCLUDE DAMBAR PROTRUSION. ALLOWABLE DAMBAR PROTRUSION SHALL BE .005 TOTAL IN EXCESS OF THE b DIMENSION AT MAXIMUM MATERIAL CONDITION.
6. DATUMS -A- AND -B- TO BE DETERMINED AT DATUM PLANE -H-.
7. DIMENSION A1 APPLIES WITHIN ZONE "J" ONLY
8. HATCHING REPRESENTS THE EXPOSED AREA OF THE HEAT SLUG. THE DIMENSIONS D1 AND E2 REPRESENT THE VALUES BETWEEN THE TWO OPPOSITE POINTS ALONG THE EDGES OF EXPOSED AREA OF HEAT SLUG.

STYLE 1:

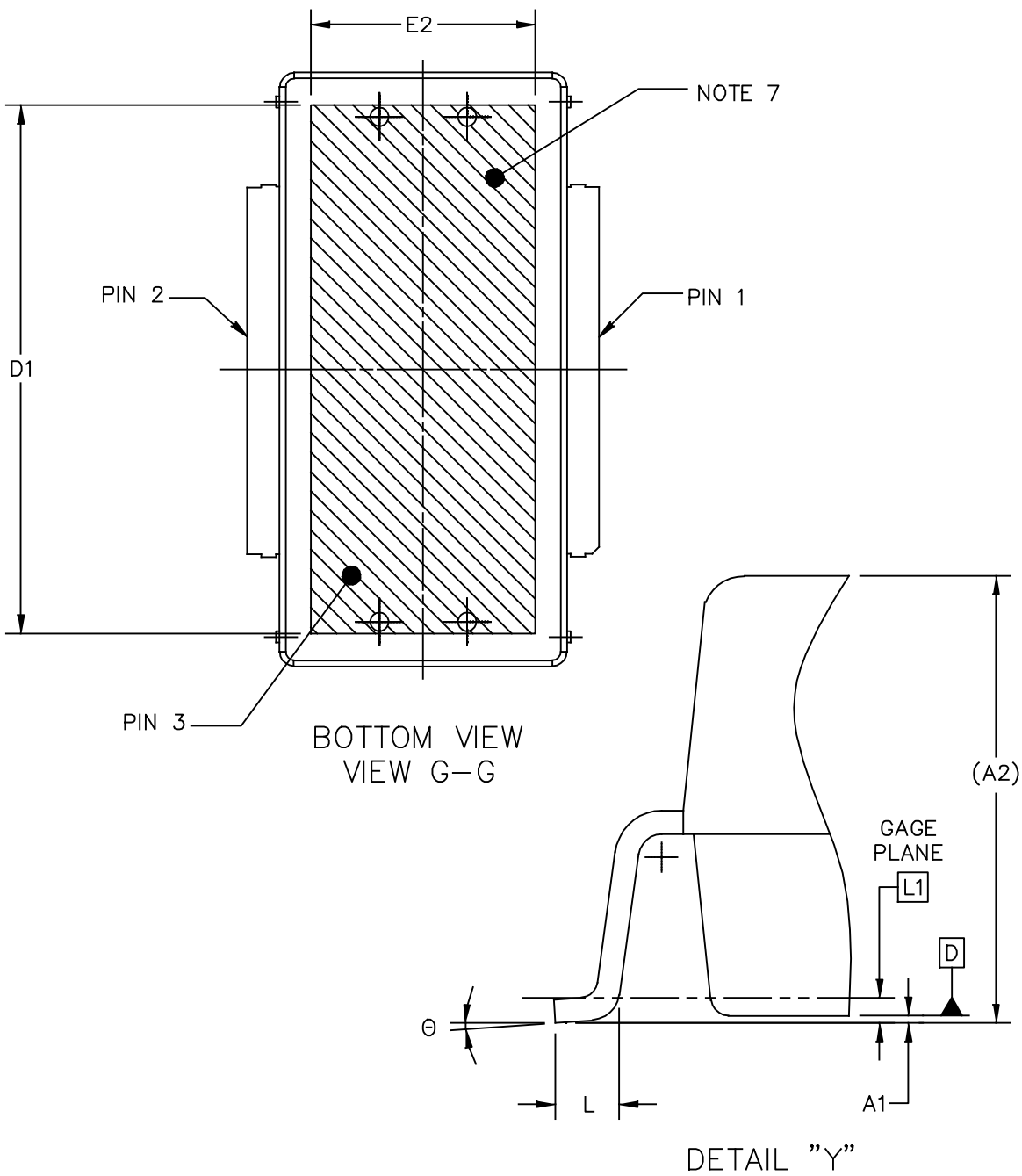
- PIN 1 - DRAIN
- PIN 2 - GATE
- PIN 3 - SOURCE

DIM	INCH		MILLIMETER		DIM	INCH		MILLIMETER	
	MIN	MAX	MIN	MAX		MIN	MAX	MIN	MAX
A	0.148	.152	3.76	3.86	b	.497	.503	12.62	12.78
A1	.059	.065	1.50	1.65	c1	.007	.011	0.18	0.28
D	.808	.812	20.52	20.62	e1	.721	.729	18.31	18.52
D1	.720	----	18.29	----					
E	.762	.770	19.36	19.56	aaa	.004		0.10	
E1	.390	.394	9.91	10.01					
E2	.306	----	7.77	----					
E3	.383	.387	9.73	9.83					
F	.025 BSC		0.635 BSC						

© FREESCALE SEMICONDUCTOR, INC. ALL RIGHTS RESERVED.		MECHANICAL OUTLINE	PRINT VERSION NOT TO SCALE
TITLE:  OM780-2 STRAIGHT LEAD	DOCUMENT NO: 98ASA10831D		REV: B
	CASE NUMBER: 2021-03		22 OCT 2009
	STANDARD: NON-JEDEC		



© FREESCALE SEMICONDUCTOR, INC. ALL RIGHTS RESERVED.	MECHANICAL OUTLINE	PRINT VERSION NOT TO SCALE	
TITLE:  OM-780-2 GULL	DOCUMENT NO: 98ASA00442D	REV: 0	
	CASE NUMBER: 2267-01	14 DEC 2011	
	STANDARD: NON-JEDEC		



© FREESCALE SEMICONDUCTOR, INC. ALL RIGHTS RESERVED.	MECHANICAL OUTLINE	PRINT VERSION NOT TO SCALE	
TITLE:  OM-780-2 GULL	DOCUMENT NO: 98ASA00442D	REV: 0	
	CASE NUMBER: 2267-01	14 DEC 2011	
	STANDARD: NON-JEDEC		



NOTES:

1. CONTROLLING DIMENSION: INCH
2. INTERPRET DIMENSIONS AND TOLERANCES PER ASME Y14.5M-1994.
3. DATUM PLANE H IS LOCATED AT TOP OF LEAD AND IS COINCIDENT WITH THE LEAD WHERE THE LEAD EXITS THE PLASTIC BODY AT THE TOP OF THE PARTING LINE.
4. DIMENSIONS D AND E1 DO NOT INCLUDE MOLD PROTRUSION. ALLOWABLE PROTRUSION IS .006 INCH (0.15 MM) PER SIDE. DIMENSIONS D AND E1 DO INCLUDE MOLD MISMATCH AND ARE DETERMINED AT DATUM PLANE H.
5. DIMENSION b DOES NOT INCLUDE DAMBAR PROTRUSION. ALLOWABLE DAMBAR PROTRUSION SHALL BE .005 INCH (0.13 MM) TOTAL IN EXCESS OF THE b DIMENSION AT MAXIMUM MATERIAL CONDITION.
6. DATUM A AND B TO BE DETERMINED AT DATUM PLANE H.
7. HATCHING REPRESENT THE EXPOSED AREA OF THE HEAT SLUG.THE DIMENSIONS D1 AND E2 REPRESENT THE VALUES BETWEEN THE TWO OPPOSITE POINTS ALONG THE EDGES OF EXPOSED AREA OF HEAT SLUG.
8. DIMPLED HOLE REPRESENTS INPUT SIDE.
9. DIMENSION A1 IS MEASURED WITH REFERENCE TO DATUM D. THE POSITIVE VALUE IMPLIES THAT THE BOTTOM OF THE PACKAGE IS HIGHER THAN THE BOTTOM OF THE LEAD.

DIM	INCH		MILLIMETER		DIM	INCH		MILLIMETER	
	MIN	MAX	MIN	MAX		MIN	MAX	MIN	MAX
A	.148	.152	3.76	3.86	b	.497	.503	12.62	12.78
A1	-.003	.003	-0.08	0.08	c1	.007	.011	0.18	0.28
A2	(.150)		(3.81)		θ	0°	8°	0°	8°
D	.808	.812	20.52	20.62	e1	.721	.729	18.31	18.52
D1	.720	----	18.29	----	aaa	.004		0.10	
E	.472	.480	11.99	12.19					
E1	.390	.394	9.91	10.01					
E2	.306	----	7.77	----					
E3	.383	.387	9.73	9.83					
L	.018	.024	0.46	0.61					
L1	.01 BSC		0.25 BSC						
© FREESCALE SEMICONDUCTOR, INC. ALL RIGHTS RESERVED.			MECHANICAL OUTLINE			PRINT VERSION NOT TO SCALE			
TITLE:  OM-780-2 GULL					DOCUMENT NO: 98ASA00442D			REV: 0	
					CASE NUMBER: 2267-01			14 DEC 2011	
					STANDARD: NON-JEDEC				

## PRODUCT DOCUMENTATION, SOFTWARE AND TOOLS

Refer to the following documents, software and tools to aid your design process.

### Application Notes

- AN1907: Solder Reflow Attach Method for High Power RF Devices in Plastic Packages
- AN1955: Thermal Measurement Methodology of RF Power Amplifiers
- AN3789: Clamping of High Power RF Transistors and RFICs in Over-Molded Plastic Packages

### Engineering Bulletins

- EB212: Using Data Sheet Impedances for RF LDMOS Devices

### Software

- Electromigration MTTF Calculator
- RF High Power Model
- .s2p File

### Development Tools

- Printed Circuit Boards

For Software and Tools, do a Part Number search at <http://www.freescale.com>, and select the “Part Number” link. Go to the Software & Tools tab on the part’s Product Summary page to download the respective tool.

## REVISION HISTORY

The following table summarizes revisions to this document.

Revision	Date	Description
0	Apr. 2014	• Initial Release of Data Sheet

### ***How to Reach Us:***

**Home Page:**  
[freescale.com](http://freescale.com)

**Web Support:**  
[freescale.com/support](http://freescale.com/support)

Information in this document is provided solely to enable system and software implementers to use Freescale products. There are no express or implied copyright licenses granted hereunder to design or fabricate any integrated circuits based on the information in this document.

Freescale reserves the right to make changes without further notice to any products herein. Freescale makes no warranty, representation, or guarantee regarding the suitability of its products for any particular purpose, nor does Freescale assume any liability arising out of the application or use of any product or circuit, and specifically disclaims any and all liability, including without limitation consequential or incidental damages. "Typical" parameters that may be provided in Freescale data sheets and/or specifications can and do vary in different applications, and actual performance may vary over time. All operating parameters, including "typicals," must be validated for each customer application by customer's technical experts. Freescale does not convey any license under its patent rights nor the rights of others. Freescale sells products pursuant to standard terms and conditions of sale, which can be found at the following address: [freescale.com/SalesTermsandConditions](http://freescale.com/SalesTermsandConditions).

Freescale and the Freescale logo are trademarks of Freescale Semiconductor, Inc., Reg. U.S. Pat. & Tm. Off. Airfast is a trademark of Freescale Semiconductor, Inc. All other product or service names are the property of their respective owners.  
© 2014 Freescale Semiconductor, Inc.

# Mouser Electronics

Authorized Distributor

Click to View Pricing, Inventory, Delivery & Lifecycle Information:

[NXP:](#)

[AFT09S200W02NR3](#) [AFT09S200W02GNR3](#)