

SMA and SMARt Multimode Connectors

Technical description

- Available for 50/125, 62.5/125, 100/140, 200/230um fibers and custom drill hole sizes
- Maximum buffer diameter : 2.46mm
- Crimp ferrule inner diameter: 4.42mm
- Typical insertion loss ranging from: <0.8dB to <2.0dB (dependant on the fiber size)
- Full range of adapters available supplied with half length and full length alignment sleeves to accommodate both 905 and 906 type connectors

Features

The SMA and SMARt connector is widely spread in industrial and medical networks requirements. The Amphenol Socapex SMA and SMARt is intermateable with the NFC93-813



905 Series SMARt Ceramic connector



906 Series SMARt Ceramic connector

Part Number	Use With Fiber Sizes (µm)	Max Buffer Diameter (mm)	Crimp ferrule Inner Diameter (mm)	Typical insertion Loss (db)	Crimp cavity	Ferrule inner Diameter (µm)
905-400-5002	100/140	2,46	4,42	<0,3	A	142 +2/-0
905-400-5007	100/140	2,46	4,42	<0,8	A	144 +2/-0
905-405-5002	50/125 62,5/125	2,46	4,42	<0,6	A	126 +2/-0
905-405-5007	50/125 62,5/125	2,46	4,42	<0,8	A	128 +2/-0
906-500-5002	100/140	2,46	4,42	<0,3	A	142 +2/-0
906-500-5007	100/140	2,46	4,42	<0,4	A	144 +2/-0
906-505-5002	50/125 62,5/125	2,46	4,42	<0,4	A	126 +2/-0
906-505-5007	50/125 62,5/125	2,46	4,42	<0,5	A	128 +2/-0

SMA and SMARt Multimode Connectors

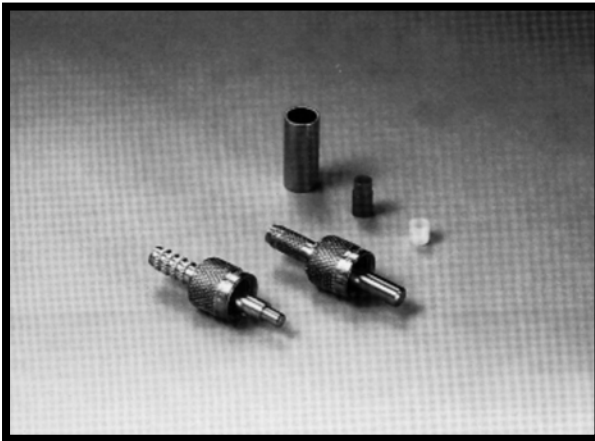







905/906-150 Series
Stainless Steel SMA Connectors

906-122 Series
Stainless Steel SMA Connectors

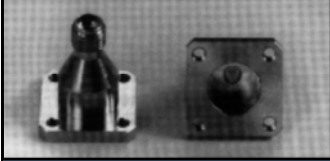
Part Number	Use With Fiber Sizes (µm)	Max Buffer Diameter (mm)	Crimp ferrule Inner Diameter (mm)	Typical insertion Loss (db)	Crimp cavity	Ferrule inner Diameter (µm)
905-150-5001	50/125 62,5/125	2,46	4,42	<2,0	A	128 + 10/-0
905-150-5002	100/140	2,46	4,42	<2,0	A	144 + 10/-0
905-150-5003	200/230	2,46	4,42	<2,0	A	231 + 10/-0
905-150-5004	400/430	2,46	4,42	<2,0	A	436 + 10/-0
905-150-5005	600/630	2,46	4,42	<2,0	A	641 + 10/-0
906-122-5000	100/140	2,46	2,92 + 4,44 4,42	<0,8	A + C	144 + 10/-0
906-122-5004	100/140	2,46	2,92 + 4,44 4,42	<1,0	A + C	128 + 10/-0

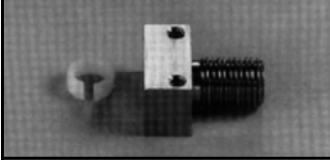
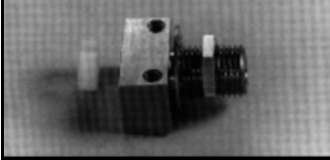
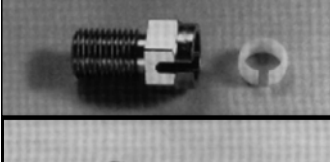
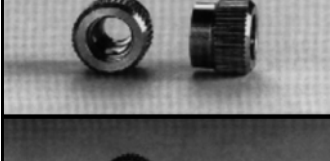
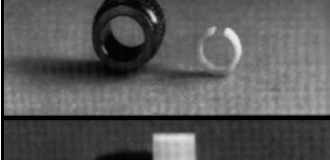
Adapters	Part Number	Description
	905-120-5000	905/906 Adapter - bulkhead feedthru, d-hole mount, jack-jack, nut and washer
	905-120-5003	905/906 Adapter - in-line, jack jack, 2 nuts and 2 washers
	905-120-5004	905/906 Half Length Adapter - nut and washer
	905-120-5008	905/906 Adapter - Environmentally-sealed, bulkhead feedthru, d-hole mount, jack jack, nut and washer
	905-120-5016	905/906 SMARt Adapter - bulkhead feedthru, d-hole mount, jack jack, nut and washer

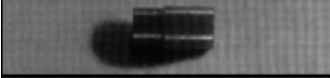
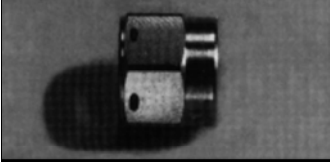
SMA and SMARt Multimode Connectors

Receptacle & Accessories	Part Number	Description
	905-117-5000	905/906 Receptacle - Flange Mount, TO-5, can or insert
	905-118-5000	905/906 Receptacle- screw mount, TO-5, can or insert
	905-138-5001	905/906 Receptacle-screw mount, TO-18, TO-46, or SE 4352 can, key-way, can alignment sleeve
	905-138-5002	905/906 Receptacle-screw mount, bulhead mount, TO-18, TO-46, or SE 4352 can, key-way, can alignment sleeve, nut and washer
	905-145-5000	905/906 Receptacle- bulhead mount, TO-18, TO 46, or SE 4352 can, key-way, nut and locker washer, can alignment sleeve
	905-5008-1	Receptacle Insert-converts TO-5 receptacle to 0.190" D
	905-5008-2	Receptacle Insert-converts TO-5 receptacle to 0.196" D
	906-101-3002	Alignment sleeve-full length- mates 906 to active device receptacle or converts 906 to 905
	906-101-3003	Alignment sleeve-full length, preferential hold, mates 905 to 906
	905-5111	905/906 coupling nut-safety wire hole, hex
	905-163	Dust Cap-905/906 adapters and receptacles

SMA and SMART Multimode Connectors

Line Drawings (dimensions in inch and mm)

905 SMART Connector

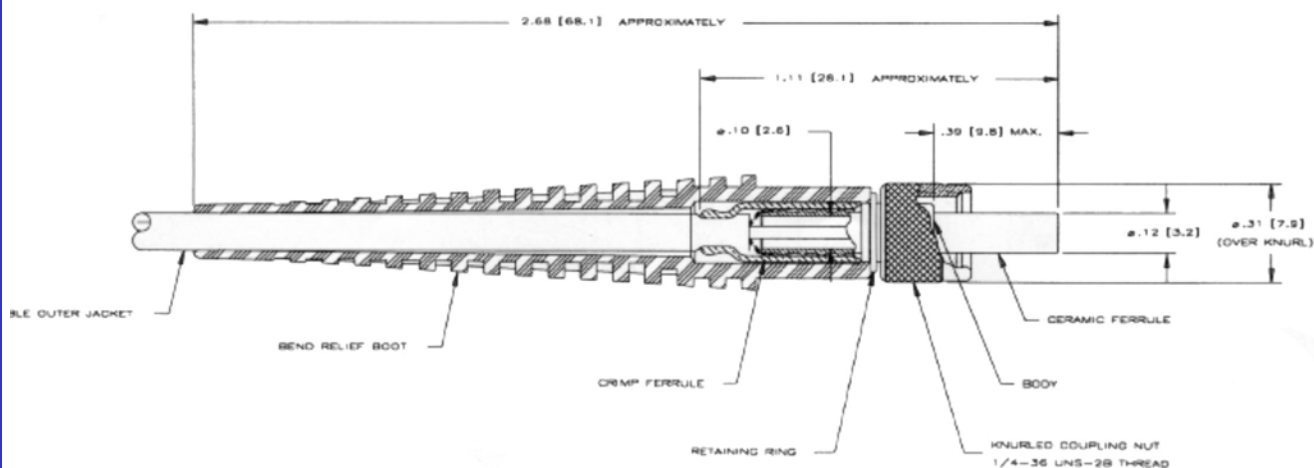

906 SMART Connector

