

ANGELETTE-S-B

~10° spot beam compatible with BJB and B+W connectors

SPECIFICATION:

Dimensions	Ø 110.0 mm
Height	57.3 mm
Fastening	socket
ROHS compliant	yes ⓘ

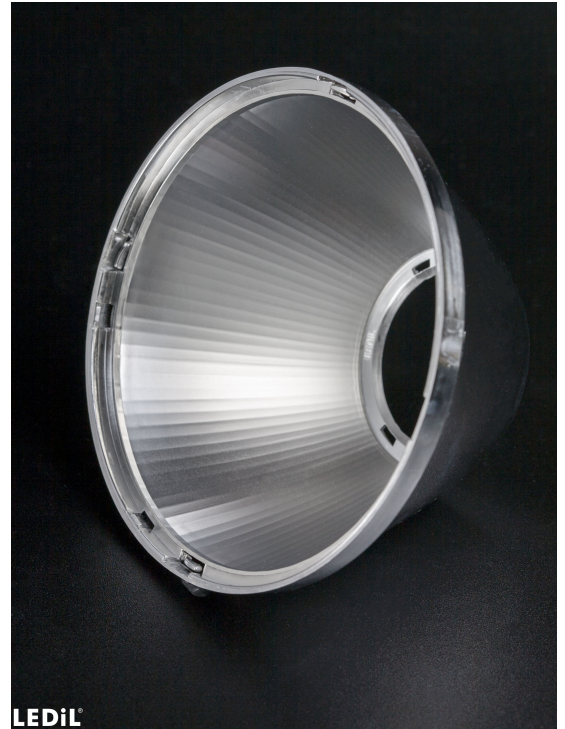

MATERIALS:

Component	Type	Material	Colour	Finish	Coating
ANGELETTE-S-B	Reflector	PC	metal		

ORDERING INFORMATION:

Component	Qty in box	MOQ	MPQ	Box weight (kg)
F14616_ANGELETTE-S-B » Box size: 398 x 298 x 265 mm	180	90	45	7.4

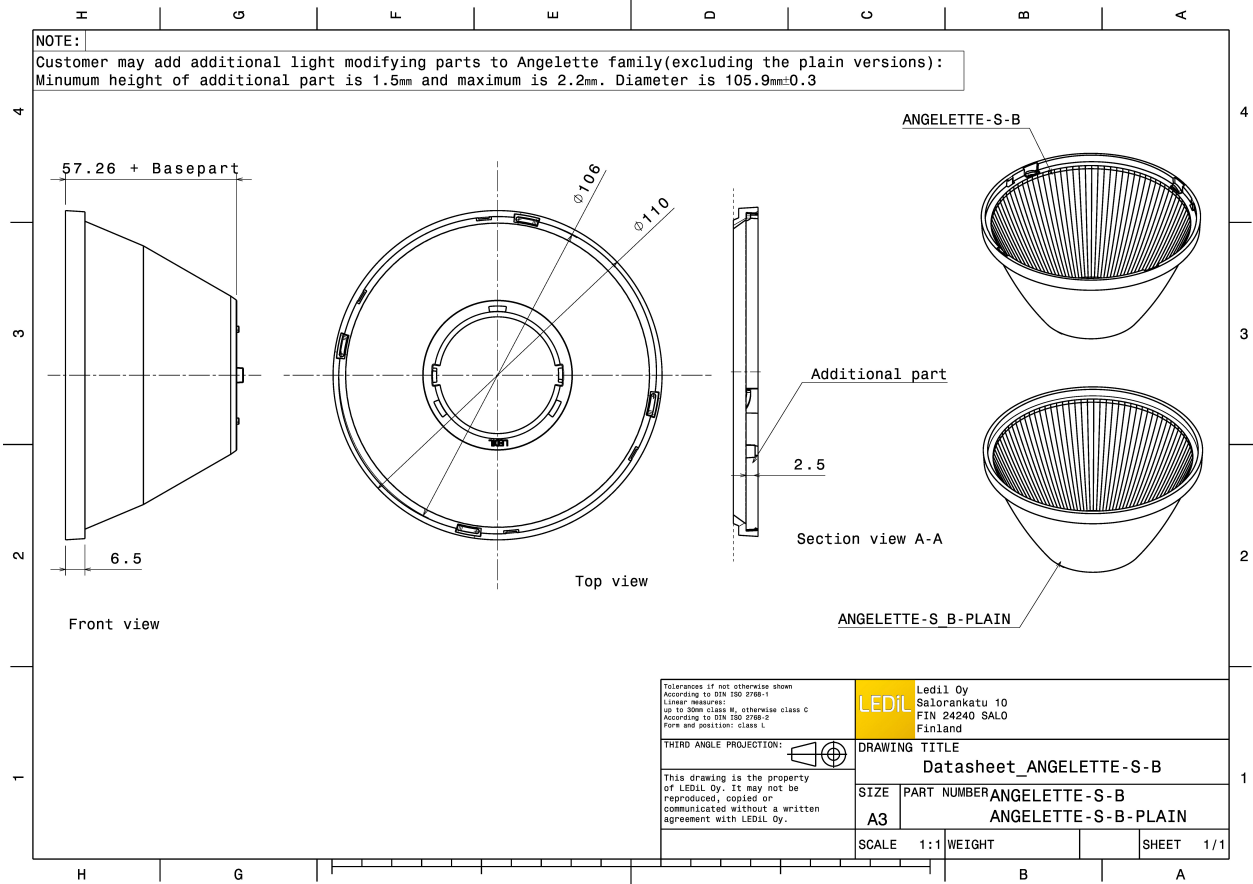

See also our general installation guide: www.ledil.com/installation_guide

OPTICAL RESULTS (MEASURED):

bridgelux

LED V15 Gen6
 FWHM / FWTM 13.0° / 26.0°
 Efficiency 91 %
 Peak intensity 7.4 cd/lm
 LEDs/each optic 1
 Light colour/type White
 Required components:
 BJB: 47.319.2224

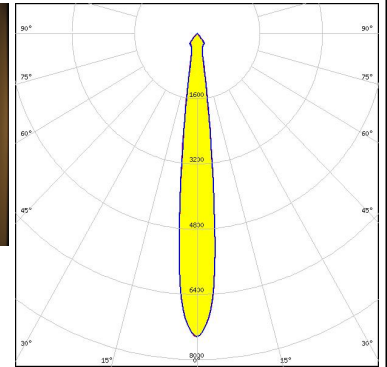

Light distribution files

bridgelux

LED V18 Gen6
 FWHM / FWTM 15.0° / 31.0°
 Efficiency 91 %
 Peak intensity 6 cd/lm
 LEDs/each optic 1
 Light colour/type White
 Required components:
 BJB: 47.319.2274

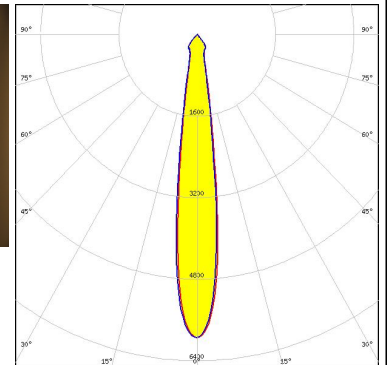

Light distribution files

bridgelux

LED V18 Gen7
 FWHM / FWTM 15.0° / 33.0°
 Efficiency 91 %
 Peak intensity 5.5 cd/lm
 LEDs/each optic 1
 Light colour/type White
 Required components:
 BJB: 47.319.2350

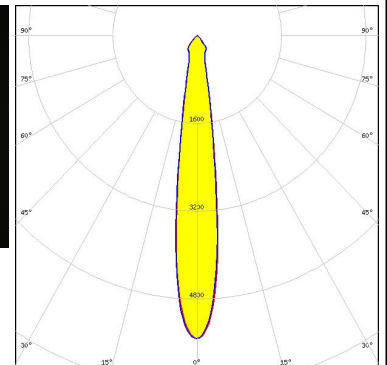
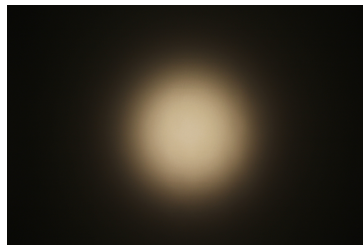

Light distribution files

OPTICAL RESULTS (MEASURED):



LED V22 Gen6
FWHM / FWTM 18.0° / 42.0°
Efficiency 89 %
Peak intensity 4.3 cd/lm
LEDs/each optic 1
Light colour/type White
Required components:
A.A.G. STUCCHI: 8102-G2

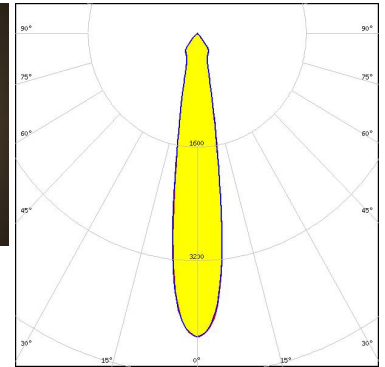

Light distribution files

CITIZEN

LED CLL03x/CLU03x
FWHM / FWTM 14.0° / 36.0°
Efficiency 85 %
Peak intensity 5.2 cd/lm
LEDs/each optic 1
Light colour/type White
Required components:
F13671_ANGE-RZ-LENS
A.A.G. STUCCHI: 8101-G2

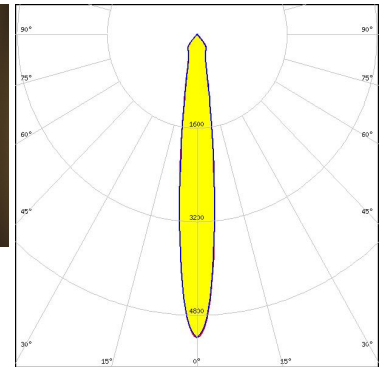

Light distribution files

CITIZEN

LED CLL03x/CLU03x
FWHM / FWTM 12.0° / 25.0°
Efficiency 91 %
Peak intensity 8.4 cd/lm
LEDs/each optic 1
Light colour/type White
Required components:
BJB: 47.319.2021

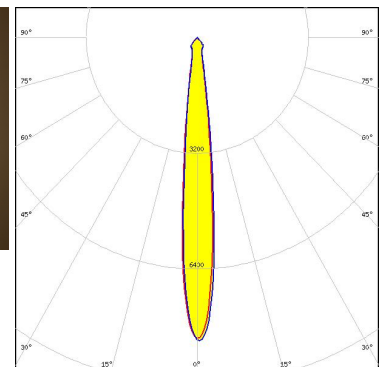

Light distribution files

OPTICAL RESULTS (MEASURED):

CITIZEN

LED CLL03x/CLU03x
 FWHM / FWTM 13.0° / 29.0°
 Efficiency 88 %
 Peak intensity 6.4 cd/lm
 LEDs/each optic 1
 Light colour/type White
 Required components:
 F15412_ANGELETTE-DL
 BJB: 47.319.2021

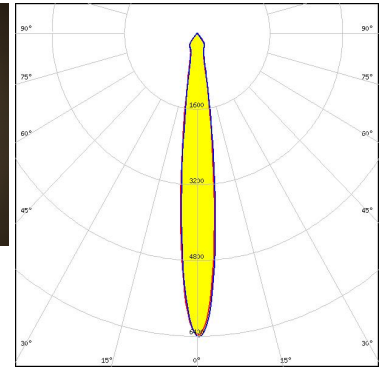

Light distribution files

CITIZEN

LED CLL03x/CLU03x
 FWHM / FWTM 12.0° / 25.0°
 Efficiency 90 %
 Peak intensity 8.1 cd/lm
 LEDs/each optic 1
 Light colour/type White
 Required components:
 A.A.G. STUCCHI: 8101-G2

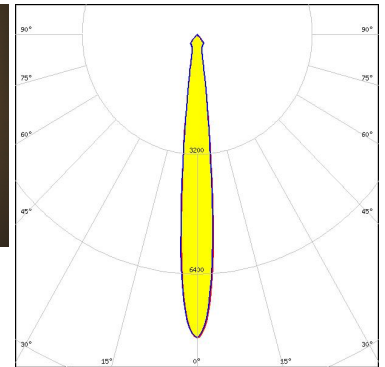

Light distribution files

CITIZEN

LED CLL03x/CLU03x
 FWHM / FWTM 12.0° / 25.0°
 Efficiency 88 %
 Peak intensity 7.8 cd/lm
 LEDs/each optic 1
 Light colour/type White
 Required components:
 F15176_ANGELETTE-LENS
 BJB: 47.319.2021

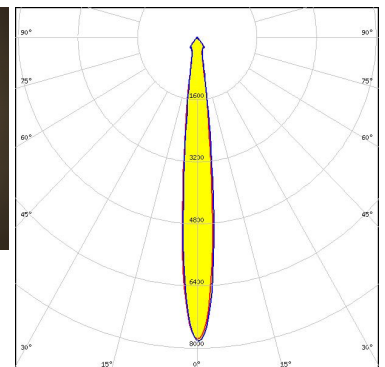

Light distribution files

OPTICAL RESULTS (MEASURED):



LED CXA/B 1816 & CXA/B 1820 & CXA 1850
 FWHM / FWTM 10.0° / 21.0°
 Efficiency 91 %
 Peak intensity 10.7 cd/lm
 LEDs/each optic 1
 Light colour/type White
 Required components:
 A.A.G. STUCCHI: 8403/G2

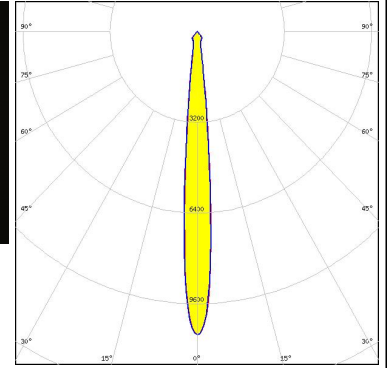
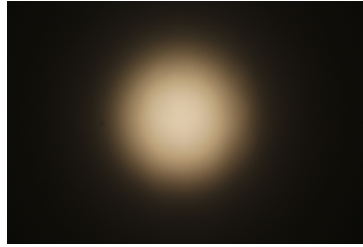

Light distribution files



LED CXA/B 25xx
 FWHM / FWTM 14.0° / 31.0°
 Efficiency 90 %
 Peak intensity 5.9 cd/lm
 LEDs/each optic 1
 Light colour/type White
 Required components:
 A.A.G. STUCCHI: 8401-G2

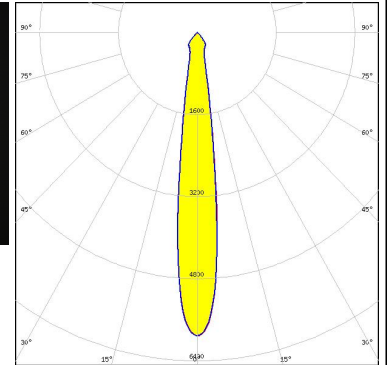
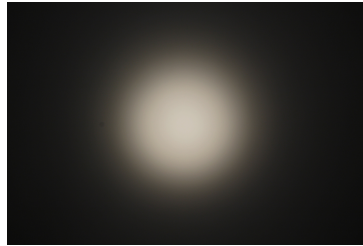

Light distribution files



LED LUXEON CoB 1208
 FWHM / FWTM 12.0° / 26.0°
 Efficiency 91 %
 Peak intensity 7.8 cd/lm
 LEDs/each optic 1
 Light colour/type White
 Required components:
 A.A.G. STUCCHI: 8301-G2

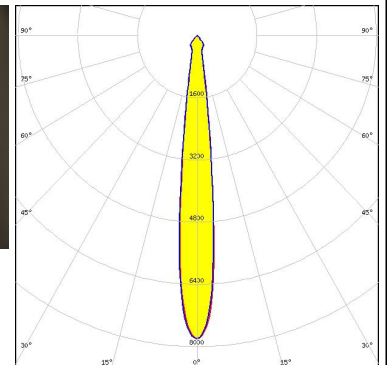

Light distribution files

OPTICAL RESULTS (MEASURED):



LED LUXEON CoB 1208
FWHM / FWTM 14.0° / 33.0°
Efficiency 87 %
Peak intensity 5.7 cd/lm
LEDs/each optic 1
Light colour/type White
Required components:
F13671_ANGE-RZ-LENS
A.A.G. STUCCHI: 8301-G2

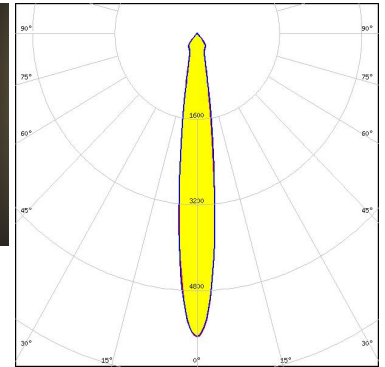

Light distribution files



LED Fortimo SLM L19 CoB
FWHM / FWTM 17.0° / 48.0°
Efficiency 90 %
Peak intensity 4.1 cd/lm
LEDs/each optic 1
Light colour/type White
Required components:
BJB: 47.319.2030

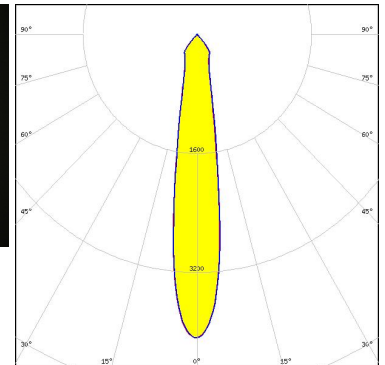
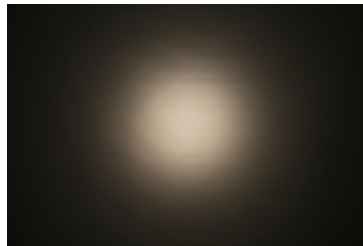

Light distribution files



LED Fortimo SLM L19 CoB
FWHM / FWTM 18.0° / 58.0°
Efficiency 86 %
Peak intensity 3.4 cd/lm
LEDs/each optic 1
Light colour/type White
Required components:
F13671_ANGE-RZ-LENS
BJB: 47.319.2030

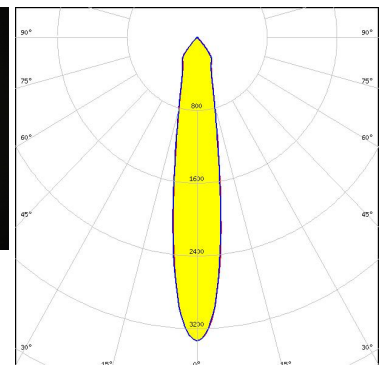
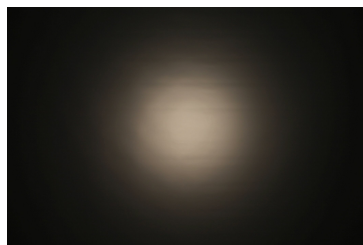

Light distribution files

OPTICAL RESULTS (MEASURED):

PHILIPS

LED Fortimo SLM L23 CoB
FWHM / FWTM 22.0° / 72.0°
Efficiency 85 %
Peak intensity 2.7 cd/lm
LEDs/each optic 1
Light colour/type White
Required components:
F13671_ANGE-RZ-LENS
BJB: 47.319.2030

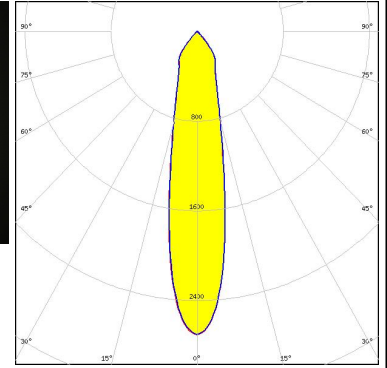

Light distribution files

PHILIPS

LED Fortimo SLM L23 CoB
FWHM / FWTM 20.0° / 64.0°
Efficiency 90 %
Peak intensity 3.3 cd/lm
LEDs/each optic 1
Light colour/type White
Required components:
BJB: 47.319.2030

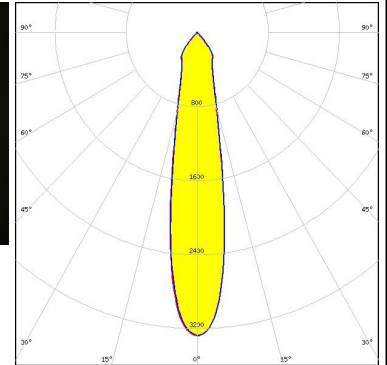

Light distribution files

SAMSUNG

LED LC016D / LC019D / LC026D / LC033D
FWHM / FWTM 14.0° / 33.0°
Efficiency 88 %
Peak intensity 5.7 cd/lm
LEDs/each optic 1
Light colour/type White
Required components:
F13671_ANGE-RZ-LENS
BJB: 47.319.2021

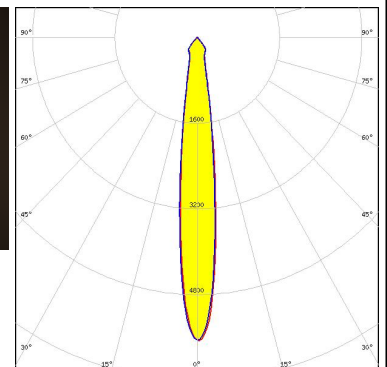
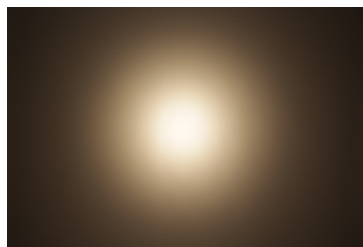

Light distribution files

OPTICAL RESULTS (MEASURED):

SAMSUNG

LED LC016D / LC019D / LC026D / LC033D
FWHM / FWTM 12.0° / 26.0°
Efficiency 91 %
Peak intensity 7.7 cd/lm
LEDs/each optic 1
Light colour/type White
Required components:
A.A.G. STUCCHI: 8101-G2

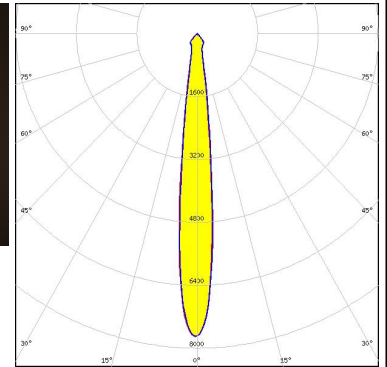

Light distribution files

SAMSUNG

LED LC016D / LC019D / LC026D / LC033D
FWHM / FWTM 14.0° / 33.0°
Efficiency 88 %
Peak intensity 5.7 cd/lm
LEDs/each optic 1
Light colour/type White
Required components:
F13671_ANGE-RZ-LENS
A.A.G. STUCCHI: 8101-G2

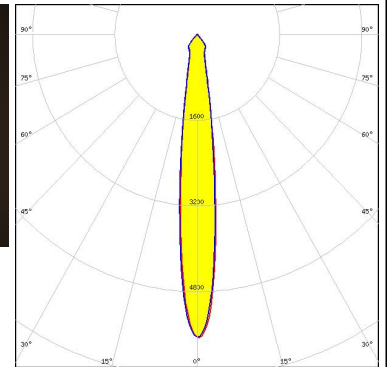

Light distribution files

SAMSUNG

LED LC016D / LC019D / LC026D / LC033D
FWHM / FWTM 12.0° / 26.0°
Efficiency 91 %
Peak intensity 7.7 cd/lm
LEDs/each optic 1
Light colour/type White
Required components:
BJB: 47.319.2021

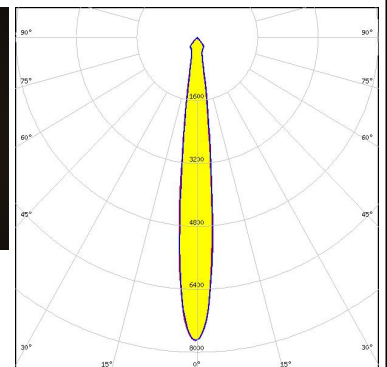

Light distribution files

OPTICAL RESULTS (MEASURED):

TRIDONIC

LED SLE G7 LES15
FWHM / FWTM 12.0° / 26.0°
Efficiency 91 %
Peak intensity 7.7 cd/lm
LEDs/each optic 1
Light colour/type White
Required components:
BJB: 47.319.2021

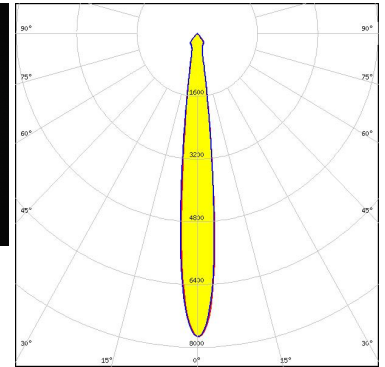
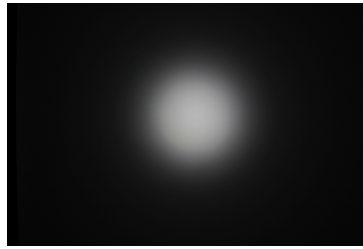

Light distribution files

TRIDONIC

LED SLE G7 LES17 H
FWHM / FWTM 14.0° / 32.0°
Efficiency 89 %
Peak intensity 5.9 cd/lm
LEDs/each optic 1
Light colour/type White
Required components:

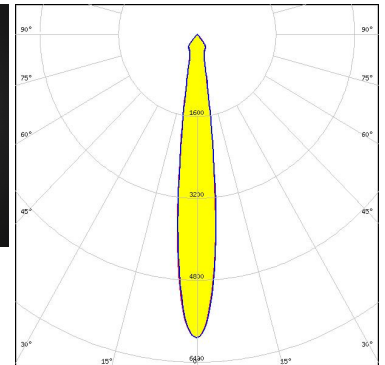

Light distribution files

TRIDONIC

LED SLE G7 LES21 H
FWHM / FWTM 18.0° / 42.0°
Efficiency 89 %
Peak intensity 4.3 cd/lm
LEDs/each optic 1
Light colour/type White
Required components:

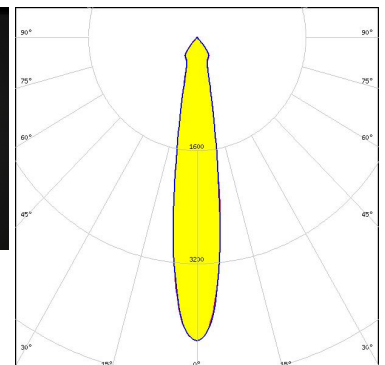

Light distribution files

OPTICAL RESULTS (MEASURED):

XICATO

LED XOB 14.5 mm
FWHM / FWTM 11.0° / 24.0°
Efficiency 92 %
Peak intensity 8.3 cd/lm
LEDs/each optic 1
Light colour/type White
Required components:
BJB: 47.319.2021

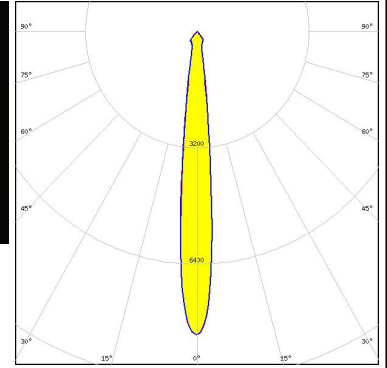

Light distribution files

OPTICAL RESULTS (SIMULATED):

CITIZEN

LED CLL03x/CLU03x
FWHM / FWTM 12.0° / 22.0°
Efficiency 90 %
Peak intensity 10.4 cd/lm
LEDs/each optic 1
Light colour/type White
Required components:

BJB: 47.319.2021

Light distribution files

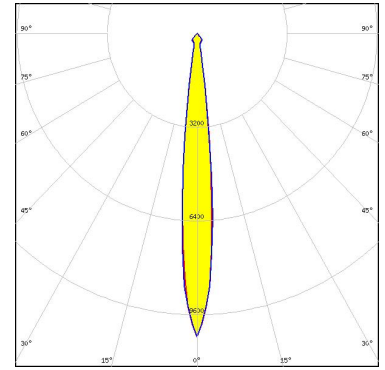

CITIZEN

LED CLL04x/CLU04x
FWHM / FWTM 17.0° / 37.0°
Efficiency 89 %
Peak intensity 4.9 cd/lm
LEDs/each optic 1
Light colour/type White
Required components:

BJB: 47.319.2030

Light distribution files

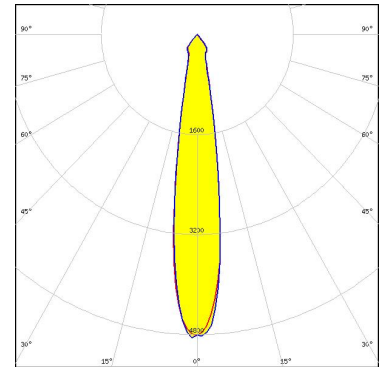

LUMILEDS

LED LUXEON CoB 1208
FWHM / FWTM 12.0° / 22.0°
Efficiency 89 %
Peak intensity 9.3 cd/lm
LEDs/each optic 1
Light colour/type White
Required components:

F15412_ANGELETTE-DL

A.A.G. STUCCHI: 8301-G2

Light distribution files

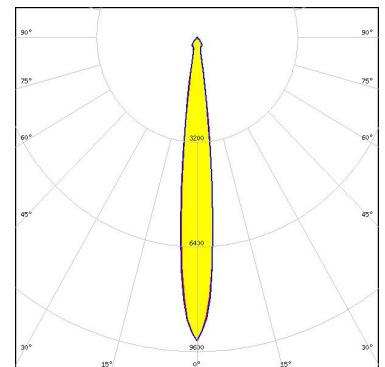

OPTICAL RESULTS (SIMULATED):

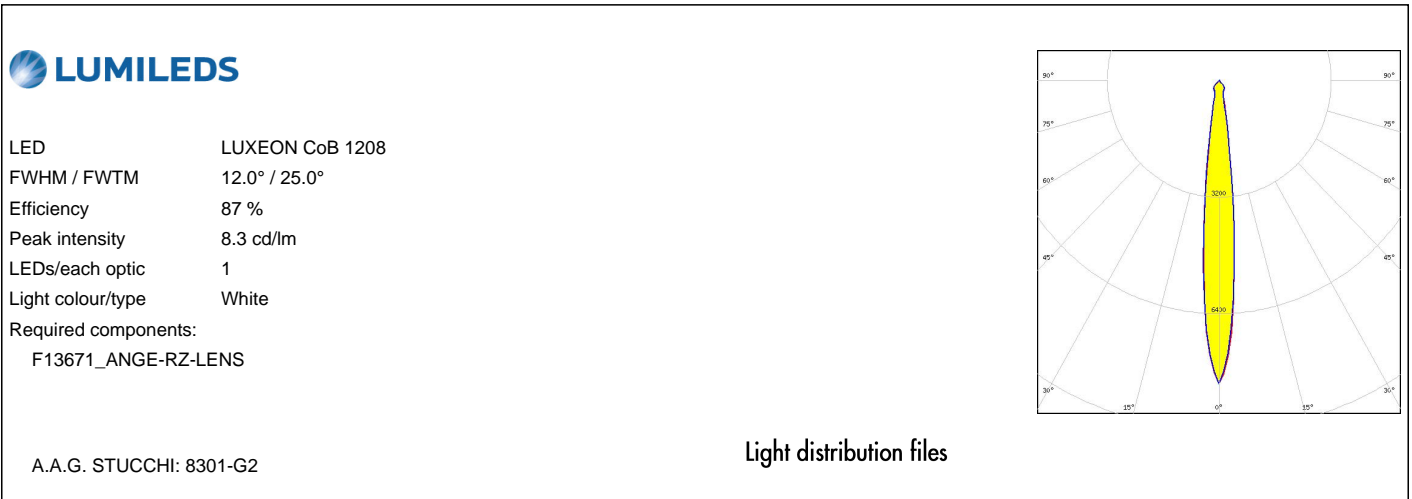

GENERAL INFORMATION:

NOTE: The typical beam angle will be changed by different color, chip size and chip position tolerance. The typical total beam angle is the full angle measured where the luminous intensity is half of the peak value.

Due to use of high power COB's with this product, special attention to proper thermal design is highly recommended. LEDiL has no liability for direct, indirect or consecutive damages arising from the LEDiL products being used outside of the recommended temperature range.

MATERIALS:

As part of our continuous research and improvement processes, and to ensure the best possible quality and availability of our products, LEDiL reserves the right to change material grades without notice.

PRODUCT DATA USER AGREEMENT AND DISCLAIMER:

The measured data in the provided downloadable LEDiL Product Datasheets and Mechanical 2D-Drawings is rounded and provided as reference for planning. LEDiL Oy's optical specifications have been verified by conducting performance testing of the products in accordance with the company's quality system. The reported data are averaged results of multiple measurements with typical variation. LEDiL Oy reserves the right to without prior notification make changes and improvements to its products.

LEDiL Oy assumes neither warranty, nor guarantee nor any other liability of any kind for the contents and correctness of the provided data. The provided data has been generated with highest diligence but the provided data may in reality not represent the complete possible variation range of all intrinsic parameters. Therefore, in certain cases a deviation from the provided data could occur.

LEDiL Oy reserves the right to undertake technical changes of its products without further notification which could lead to changes in the provided data. LEDiL Oy assumes no liability of any kind for the possible deviation from any provided data or any other damage resulting from the usage of the provided data.

The user agrees to this disclaimer and user agreement with the download or usage of the provided files.

LEDiL Oy

Joensuunkatu 13
FI-24240 SALO
Finland

LEDiL Inc.

228 West Page Street
Suite D
Sycamore IL 60178
USA

Ledil Optics Technology (Shenzhen) Co., Ltd.

405 , Block B
Casic Motor Building
Shenzhen 518057
P.R.CHINA

Local sales and technical support

[www.ledil.com/
where_to_buy](http://www.ledil.com/where_to_buy)

Shipping locations

Poznan, Poland
Hong Kong, China

Distribution Partners

[www.ledil.com/
where_to_buy](http://www.ledil.com/where_to_buy)