

03 KFR

Circular connectors with threaded joint M16 acc. to IEC 61076-2-106, IP40/IP68



Chassis socket acc. to IEC 61076-2-106, IP40, with threaded joint, for printed circuit boards, for front mounting

03 KFR

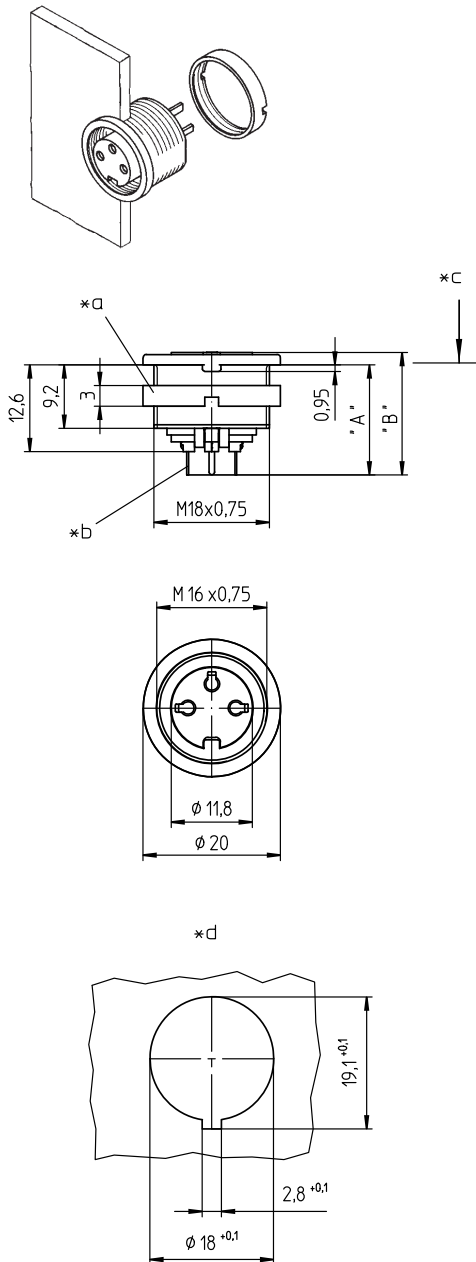

Environmental conditions

Temperature range -40 °C/+85 °C

Materials

Insulating body PA GF, V-0 according to UL94
 Contact bush CuZn, silver-plated and flash gold-plated, tin-plated in solder area (3-8 poles)
 CuZn, pre-nickel and gold-plated, tin-plated in solder area (12 poles)
 Housing Zn diecast, pre-copper and nickel-plated
 Ring screw CuZn, nickel-plated

Mechanical data

Insertion force/contact ≤ 5.0 N¹
 Withdrawal force/contact ≥ 1.2 N (3-8 poles)
 ≥ 0.9 N (12 poles)¹
 Tightening torque connector 1-3 Nm
 Tightening torque nut 1-3 Nm
 Protection class IP40²

¹ measured with a polished steel pin, nominal thickness 1.5 mm (1.0 mm with 12 poles)
² according to IEC DIN EN 60529, only in locked condition with an appropriate counterpart

Electrical data (at T_{amb} 20 °C)

Contact resistance ≤ 5 mΩ
 Rated current 5 A (T_{amb} 40 °C, 3-8 poles)
 3 A (T_{amb} 40 °C, 12 poles)
 Rated voltage with pollution degree 1:
 300 V (versions 30, 40, 50/6, 60, 70)
 100 V (versions 50, 71, 80, 81)
 160 V (Polbild 120)
 with pollution degree 2:
 250 V (versions 30, 40)
 32 V (versions 50, 71, 80, 81)
 160 V (versions 50/6, 60, 70, 120)
 Rated impulse voltage 1500 V (versions 30, 40, 50/6, 60, 70, 120)
 500 V (versions 50, 71, 80, 81)
 Material group II (IEC)/I (UL) (400 ≤ CTI < 600)
 Overvoltage category I
 Insulation resistance > 100 MΩ

Pin configurations, solder side view



03-a
KFR 30

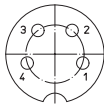

04-a
KFR 40

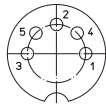

05-b
KFR 50

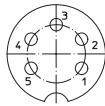

05-a
KFR 50/6

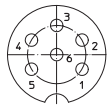

06-a
KFR 60

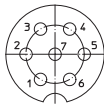

07-a
KFR 70

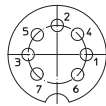

07-b
KFR 71



KFR 80

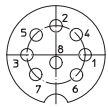







08-a
KFR 81









12-a
KFR 120

Associated products

Counterparts

- | | | |
|--|--|--|
|  SV |  SV ... C |  SV ...-8 |
|  SV ...-8 C |  SV ...-8 C |  WSV |
|  WSV ... C | | |

Accessories

- | | | |
|--|--|--|
|  0381 |  038199 |  0382 |
|  0384 |  0385 |  038799 |

Harnessing equipment

-  ZMS 20

03 KFR

Printed circuit board layout, solder side view

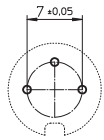

03-a
KFR 30

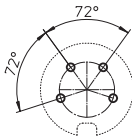

04-a
KFR 40

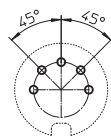

05-b
KFR 50

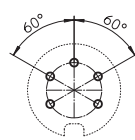

05-a
KFR 50/6

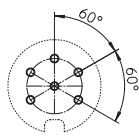

06-a
KFR 60

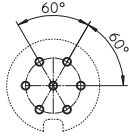

07-a
KFR 70

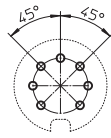

07-b
KFR 71

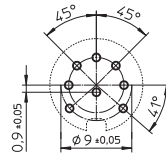

KFR 80

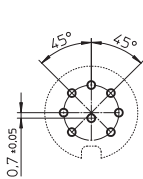

08-a
KFR 81

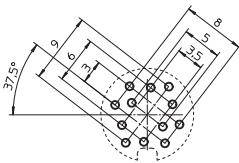

12-a
KFR 120

- *a nut enclosed separately
- *b for bore hole of printed circuit board
Ø 1.0 mm (KFR 30–81)
Ø 0.7 mm (KFR 120)
- *c mounting direction
- *d port in mounting plate

03

KFR

Designation	Pole Number	PU (Pieces)	MDQ (Pieces)	Dimensions	
				A (mm)	B (mm)
KFR 30	3	50	100	16.0	17.8
KFR 40	4	50	100	16.0	17.8
KFR 50	5	50	100	16.0	17.8
KFR 50/6	5	50	100	16.0	17.8
KFR 60	6	50	100	16.0	17.8
KFR 70	7	50	100	16.0	17.8
KFR 71	7	50	100	16.0	17.8
KFR 80	8	50	100	16.0	17.8
KFR 81	8	50	100	16.0	17.8
KFR 120	12	50	100	15.6	17.1

Packaging:

in a cardboard box