

76×20 mm

San Ace B76 9BD type 



General Specifications

- Material Frame: Plastic (Flammability: UL 94V-0), Impeller: Plastic (Flammability: UL 94V-0)
- Expected life See the table below. (L10 life: 90% survival rate for continuous operation in free air at 60°C, rated voltage)
- Motor protection function Locked rotor burnout protection, Reverse polarity protection
For details, please refer to p. 529.
- Dielectric strength 50/60 Hz, 500 VAC, for 1 minute (between lead wire conductors and frame)
- Insulation resistance 10 MΩ or more with a 500 VDC megger (between lead wire conductors and frame)
- Sound pressure level (SPL) At 1 m away from the air inlet
- Storage temperature -30 to +70°C (Non-condensing)
- Lead wire ⊕Red ⊖Black (Sensor) Yellow
- Mass 58 g

Specifications

The models listed below **have pulse sensors**.

Model no.	Rated voltage [V]	Operating voltage range [V]	Rated current [A]	Rated input [W]	Rated speed [min ⁻¹]	Max. airflow [m ³ /min] [CFM]	Max. static pressure [Pa] [inchH ₂ O]	SPL [dB (A)]	Operating temperature [°C]	Expected life [h]
9BD12SC6-1	12	5 to 13.8	0.28	3.36	4500	0.29 10.2	300 1.2	43	-20 to +70	40000/60°C (70000/40°C)
9BD12HC6-1		5.5 to 13.8	0.21	2.52	4200	0.27 9.5	230 0.92	41		
9BD12FC6-1			0.18	2.16	3900	0.25 8.8	200 0.8	39		
9BD24SC6-1	24	10 to 27.6	0.14	3.36	4500	0.29 10.2	300 1.2	43		
9BD24HC6-1			0.12	2.88	4200	0.27 9.5	230 0.92	41		
9BD24FC6-1			0.1	2.4	3900	0.25 8.8	200 0.8	39		

Other sensor specifications are available as options. Refer to the index (p. 547).

Airflow - Static Pressure Characteristics

9BD12SC6-1 With pulse sensor

Operating voltage range

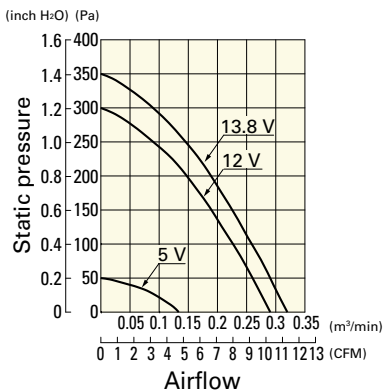

9BD12HC6-1 With pulse sensor

Operating voltage range

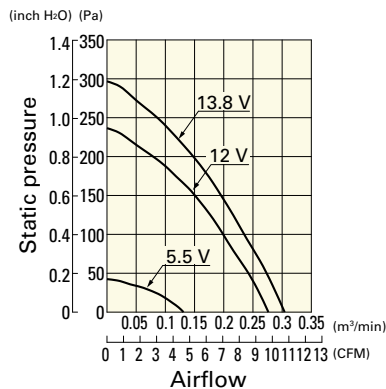

9BD12FC6-1 With pulse sensor

Operating voltage range

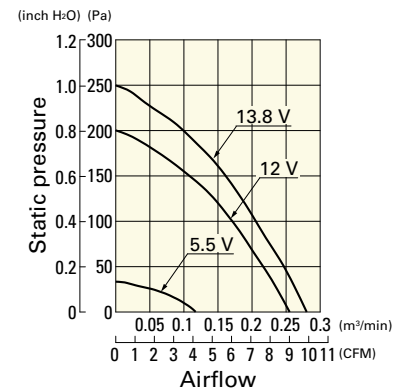

Airflow - Static Pressure Characteristics

9BD24SC6-1 With pulse sensor

Operating voltage range

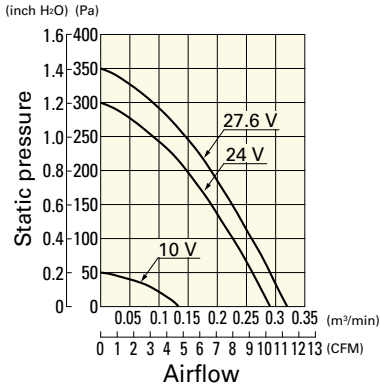

9BD24HC6-1 With pulse sensor

Operating voltage range

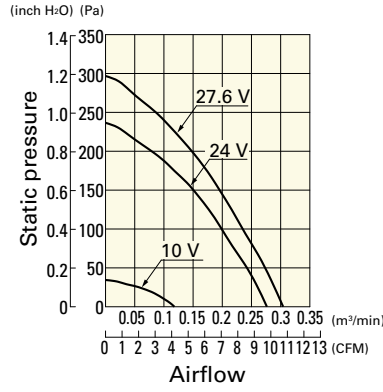

9BD24FC6-1 With pulse sensor

Operating voltage range

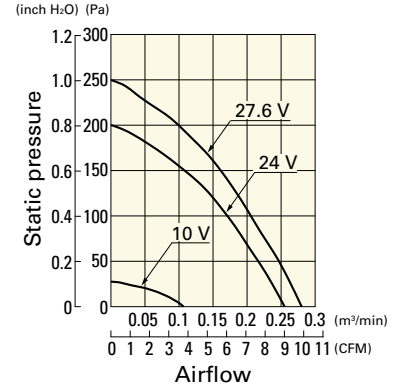

Dimensions (unit: mm)

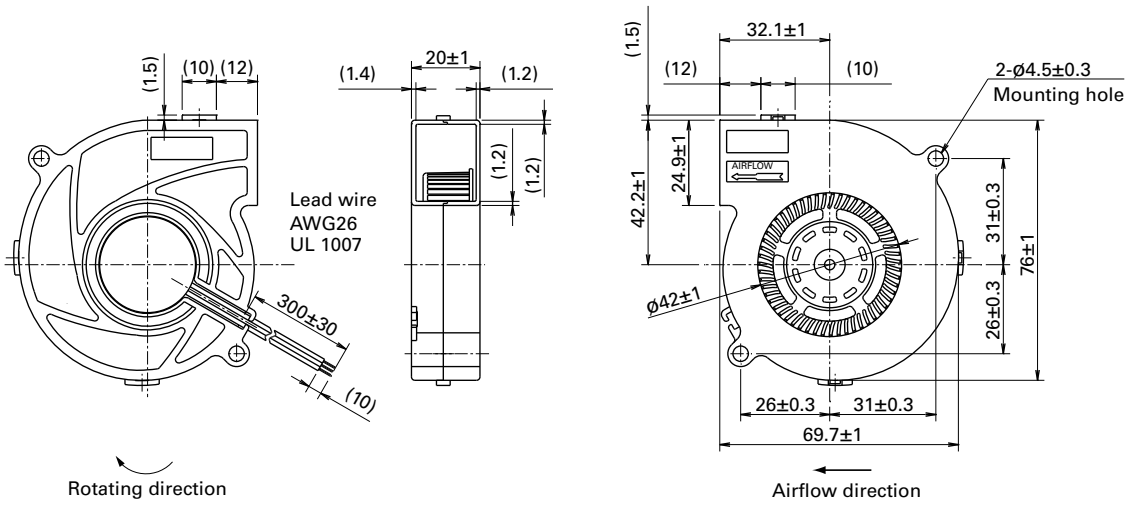

Blower 76 mm DC

Mouser Electronics

Authorized Distributor

Click to View Pricing, Inventory, Delivery & Lifecycle Information:

Sanyo Denki:

[9BD12SC6-1](#) [9BD12FC6-1](#) [9BD12HC6-1](#) [9BD24HC6-1](#) [9BD24FC6-1](#) [9BD24SC6-1](#) [9BD12FA6-1](#) [9BD12HA6-1](#)
[9BD12SA6-1](#) [9BD24FA6-1](#) [9BD24HA6-1](#) [9BD12P6S01](#) [9BD24P6S06](#) [9BD24SA6-1](#) [9BD24SD6-1](#)