



Wireless 5V Pressure Meters

General Description

The ALTA wireless pressure sensor measures pressure from a 5 volt pressure transducer and transmits the pressure measurement to iMonnit. This solution combines a standard pressure transducer interfaced to a Monnit ALTA wireless radio.

- Measure pressure with 50 or 300 PSIG transducers (others available upon request).
- Measure non-caustic liquid or vapor pressures.
- Pressure transducer is NEMA 4X (IP66), CE rated.

Principle of Operation

By connecting the ALTA wireless pressure sensor to a pressurized gas, liquid or vapor supply line, it can measure the pressure within the line and send data to the iMonnit Online Sensor Monitoring and Notification System. The data is stored in the online system and can be reviewed and exported as a data sheet or graph. User customization allows you to set notifications and alerts from the system so you can know immediately if pressure is above or below an optimal range.

Example Interfacing

- Compressors/Compressed Air Lines
- Water Supply Lines
- Pumping Systems
- Irrigations System Pressure
- Industrial Process Monitoring
- Trash Compaction Equipment

Features of Monnit ALTA Sensors

- Wireless range of 1,000+ feet through 12-14 walls.*
- Frequency Hopping Spread Spectrum (FHSS).
- Improved interference immunity.
- Improved power management for longer battery life.** (10+ years on AA batteries)
- Encrypt-RF™ Security (Diffie-Hellman Key Exchange + AES-128 CBC for sensor data messages).
- Onboard data memory / storage (up to 512 readings per sensor).
 - 10 min heartbeats = 3.5 days
 - 2 hour heartbeats = 42 days
- Over-the-air updates (future proof).
- Free iMonnit basic online wireless sensor monitoring and notification system to configure sensors, view data and set alerts via SMS text and email.

* Actual range may vary depending on environment.

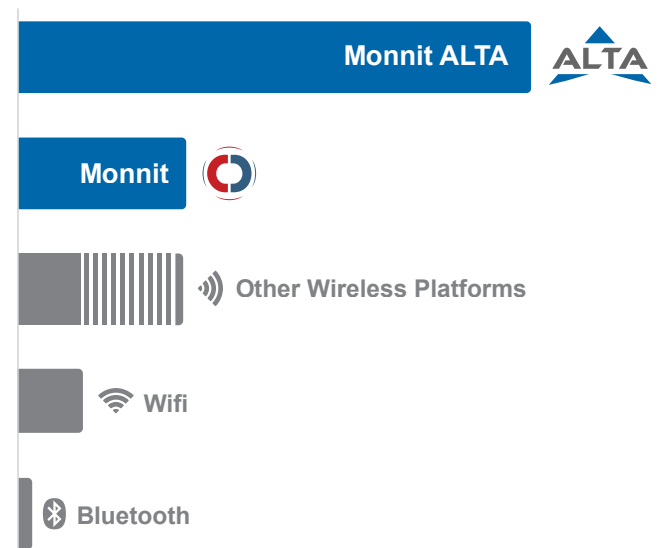

** Battery life is determined by sensor reporting frequency and other variables. Other power options are also available.

Wireless Range Comparison

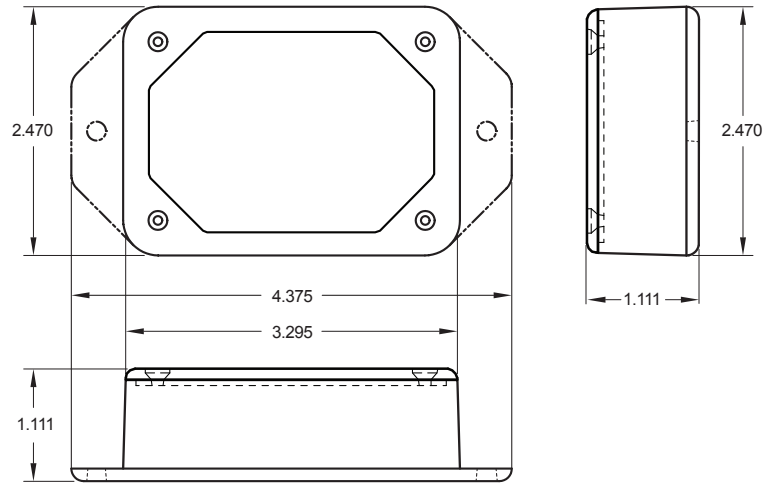



ALTA Commercial AA Wireless Pressure Meter - Technical Specifications

Supply Voltage	2.0 - 3.8 VDC (3.0 - 3.8 VDC Using Power Supply) *
Current Consumption	0.2 μ A (Sleep Mode) 0.7 μ A (RTC Sleep) 570 μ A (MCU Idle) 2.5 mA (MCU Active) 5.5 mA (Radio RX Mode) 22.6 mA (Radio TX Mode)
Operating Temperature Range (Board Circuitry and Batteries)	-18°C to 55°C (0°F to 130°F) using alkaline -40°C to 85°C (-40°F to 185°F) using lithium **
Optimal Battery Temperature Range (AA)	+10°C to +50°C (+50°F to +122°F)
Integrated Memory	Up to 512 sensor messages
Wireless Range	1,000+ ft. non-line-of-sight
Security	Encrypt-RF™ (256-bit key exchange and AES-128 CTR)
Weight	10.3 Ounces
Certifications	   Industry Canada 900 MHz product; FCC ID: ZTL- G2SC1 and IC: 9794A-G2SC1. 868 and 433 MHz product tested and found to comply with: EN 300 220-2 V3.1.1 (2017-02), EN 300 220-2 V3.1.1 (2017-02) and EN 60950.

* Hardware cannot withstand negative voltage. Please take care when connecting a power device.

** At temperatures above 100°C, it is possible for the board circuitry to lose programmed memory.

Power Options



The standard version of this sensor is powered by two replaceable 1.5 V AA sized batteries (included with purchase).

This sensor is also available with a line power option. The line powered version of this sensor has a barrel power connector allowing it to be powered by a standard 3.0 - 3.6 V power supply. The line powered version also uses two standard 1.5 V AA batteries as backup for un-interrupted operation in the event of line power outage.

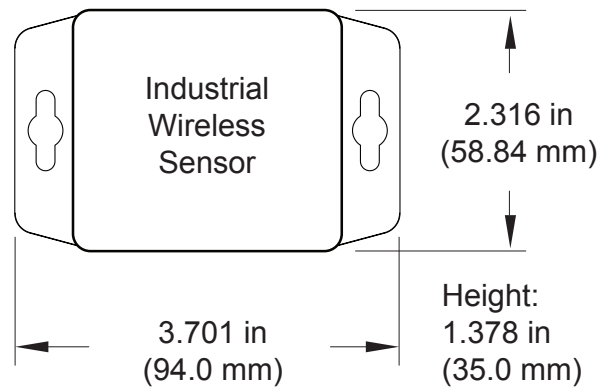
Power options must be selected at time of purchase, as the internal hardware of the sensor must be changed to support the selected power requirements.



ALTA Industrial Wireless Pressure Meter - Technical Specifications

Supply Voltage	2.0 - 3.8 VDC (3.0 - 3.8 VDC Using Power Supply) *	
Current Consumption	0.2 μ A (Sleep Mode) 0.7 μ A (RTC Sleep) 570 μ A (MCU Idle) 2.5 mA (MCU Active) 5.5 mA (Radio RX Mode) 22.6 mA (Radio TX Mode)	
Operating Temperature Range (Board Circuitry and Battery)	-40°C to +85°C (-40°F to +185°F) **	
Included Battery	Max Temperature Range:	-40° to +85°C (-40° to +185°F)
	Capacity:	1800 mAh
Optional Solar Feature	Solar Panel:	5VDC / 30mA (53mm x 30mm)
	Charging Temperature Range:	0° to 45°C (32° to 113°F)
	Max Temperature Range:	-20° to 60°C (-4° to 140°F)
	Included Rechargeable Battery:	600 mAh / >2000 Charge Cycles (80% of initial capacity)
Integrated Memory	Up to 512 sensor messages	
Wireless Range	1,000+ ft. non-line-of-sight	
Security	Encrypt-RF™ (256-bit key exchange and AES-128 CTR)	
Weight	13.3 Ounces	
Enclosure Rating	NEMA 1, 2, 4, 4x, 12 and 13 rated, sealed and weather proof	
UL Rating	UL Listed to UL508-4x specifications (File E194432)	
Certifications	   Industry Canada	900 MHz product; FCC ID: ZTL- G2SC1 and IC: 9794A-G2SC1. 868 and 433 MHz product tested and found to comply with: EN 300 220-2 V3.1.1 (2017-02), EN 300 220-2 V3.1.1 (2017-02) and EN 60950.

* Hardware cannot withstand negative voltage. Please take care when connecting a power device.

** At temperatures above 100°C, it is possible for the board circuitry to lose programmed memory.

Pressure Transducer Specifications	
Operating Temperature	0 to 175°F (-18 to 79°C).
Thermal Effect on Reading	±0.02% FS/°F. (includes zero and span).
Media	Gas, Liquid or Vapor
Response Time	300 msec.
Stability	1.0% FS/year (Typ.).
Wire Length	1 Meter
Accuracy	1.0% FS; 0.5% RSS; (Includes linearity, hysteresis, and repeatability)
Process Connection	¼" NPT-Male Standard
Pressure Transducer(s)	50 or 300 PSIG (Others available upon request)
5V Transducer Interface Board Specifications	
Max Voltage Output	5.5 V
Typical Voltage Output	5.0 V
Max Voltage Input	0 - 15 V
Voltage Measurement Range	0 - 5.2 V ***
Voltage Measurement Resolution	~0.5 mV
Voltage Measurement Accuracy	± (2% of reading + 1.5 mV)
Input Impedance	13 kOhm
Combined Specifications	
Pressure Measurement Accuracy	± (2% of reading + 1.05% FS)
User Calibrated Pressure Accuracy	± (0.5% of reading + 0.5% FS) ****

*** The sensor is capable of measuring above 5 volts but may not meet the specified accuracy above this value.

**** For best results first zero the sensor then calibrate at greater than 20% maximum pressure of the transducer.

Commercial Grade Sensors:

Monnit commercial grade sensors are designed for applications in ordinary environments (normal room temperature, humidity and atmospheric pressure). Do not use these sensors under the following conditions as these factors can deteriorate the product characteristics and cause failures and burn-out. (Corrosive gas or deoxidizing gas - chlorine gas, hydrogen sulfide gas, ammonia gas, sulfuric acid gas, nitric oxides gas, etc.). Volatile or flammable gas. Dusty conditions. Under low or high pressure. Wet or excessively humid locations. Places with salt water, oils chemical liquids or organic solvents. Where there are excessively strong vibrations. Other places where similar hazardous conditions exist.)

Use these product within the specified temperature range. Higher temperature may cause deterioration of the characteristics or the material quality.

Industrial Grade Sensors - Type 1, 2, 4, 4X, 12 and 13 NEMA Rated Enclosure:

Monnit's Industrial sensors are enclosed in reliable, weatherproof NEMA rated enclosures. Our NEMA rated enclosures are constructed for both indoor or outdoor use and protect the sensor circuitry against the ingress of solid foreign objects like dust as well as the damaging effects of water (rain, sleet, snow, splashing water, and hose directed water).

- Safe from falling dirt.
- Protects against wind blown dust.
- Protects against rain, sleet, snow, splashing water, and hose directed water
- Increased level of corrosion resistance
- Will remain undamaged by ice formation on the enclosure



Monnit Corporation
3400 South West Temple
Salt Lake City, UT 84115
801-561-5555
www.monnit.com

For more information about our products or to place an order, please contact our sales department at 801-561-5555. Visit us on the web at www.monnit.com.

Mouser Electronics

Authorized Distributor

Click to View Pricing, Inventory, Delivery & Lifecycle Information:

Monnit:

[MNS2-9-IN-PS-050](#) [MNS2-9-IN-PS-050-SOL](#) [MNS2-9-IN-PS-300](#) [MNS2-9-IN-PS-300-SOL](#) [MNS2-9-W2-PS-050](#)
[MNS2-9-W2-PS-300](#) [MNS2-8-IN-PS-050](#) [MNS2-8-IN-PS-050-SOL](#) [MNS2-8-IN-PS-300](#) [MNS2-8-IN-PS-300-SOL](#)
[MNS2-8-W2-PS-050](#) [MNS2-8-W2-PS-300](#) [MNS2-4-IN-PS-050](#) [MNS2-4-IN-PS-050-SOL](#) [MNS2-4-IN-PS-300](#) [MNS2-4-W2-PS-050](#) [MNS2-4-W2-PS-300](#) [MNS2-4-IN-PS-300-SOL](#)