

S3ABF~S3MBF

Rev.D May.-2019

描述 / Descriptions

表面贴装整流二极管，反向电压：50V~1000V，正向电流：3.0A，薄型 SMBF 封装。

Surface Mount General Purpose Silicon Rectifiers, Reverse Voltage: 50 to 1000V, Forward

Current: 3.0A, SMBF thin package.

特征 / Features

玻璃钝化芯片，无铅符合欧盟 RoHS 指令 2011/65/EU，适用于表面贴装。无卤产品。

Glass Passivated Chip Junction, Lead free in comply with EU R0HS 2011/65/EU directives, For surface mounted applications. Halogen free product.

用途 / Applications

一般用途。

General purpose.

内部等效电路 / Equivalent Circuit



引脚排列 / Pinning

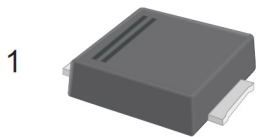

2

PIN	DESCRIPTION
1	Cathode
2	Anode

The recommended mounting pad size

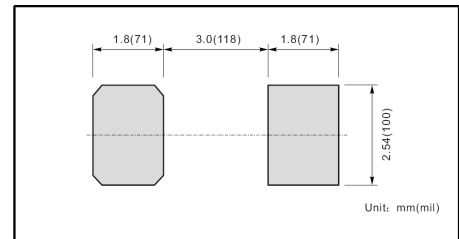

印章代码 / Marking

见印章说明。See Marking Instructions.

极限参数 / Absolute Maximum Ratings(Ta=25°C)

参数 Parameter	符号 Symbol	数值 Rating							单位 Unit
		S3ABF	S3BBF	S3DBF	S3GBF	S3JBF	S3KBF	S3MBF	
Maximum Repetitive Peak Reverse Voltage	V_{RRM}	50	100	200	400	600	800	1000	V
Maximum RMS voltage	V_{RMS}	35	70	140	280	420	560	700	V
Maximum DC Blocking Voltage	V_{DC}	50	100	200	400	600	800	1000	V
Maximum Average Forward Rectified Current at $T_a=115^\circ\text{C}$	$I_{F(AV)}$	3.0							A
Peak Forward Surge Current 8.3 ms Single Half Sine Wave Superimposed on Rated Load (JEDEC Method)	I_{FSM}	100							A
Typical Junction Capacitance ¹⁾	C_j	35							pF
Typical Thermal Resistance ²⁾	$R_{\theta JA}$	45							°C/W
	$R_{\theta JC}$	15							
Operating and Storage Temperature Range	T_j, T_{stg}	-55~+150							°C

Note:

1) Measured at 1MHz and applied reverse voltage of 4V D.C

2) P.C.B. mounted with 2.0" X 2.0" (5 X 5 cm) copper pad areas.

电性能参数 / Electrical Characteristics(Ta=25°C)

参数 Parameter	符号 Symbol	测试条件 Test Conditions	数值 Rating	单位 Unit
Maximum Forward Voltage	V_F	$I_F=3.0A$	1.1	V
Maximum DC Reverse Current at Rated DC Blocking Voltage	I_R	$T_a=25^\circ\text{C}$	5.0	μA
		$T_a=125^\circ\text{C}$	150	μA

电参数曲线图 / Electrical Characteristic Curve

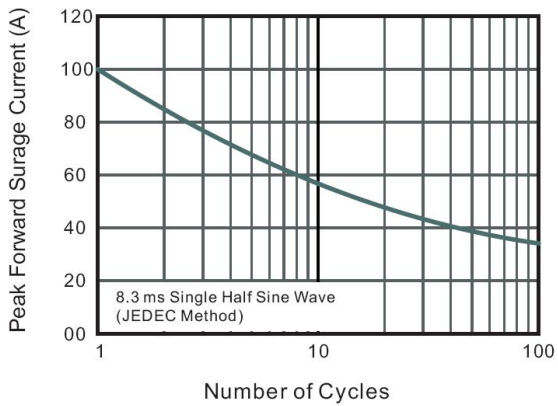
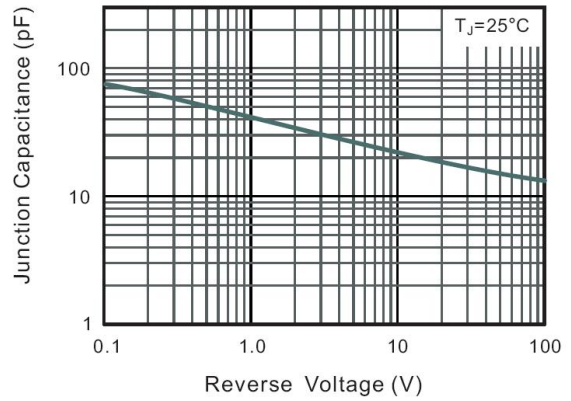
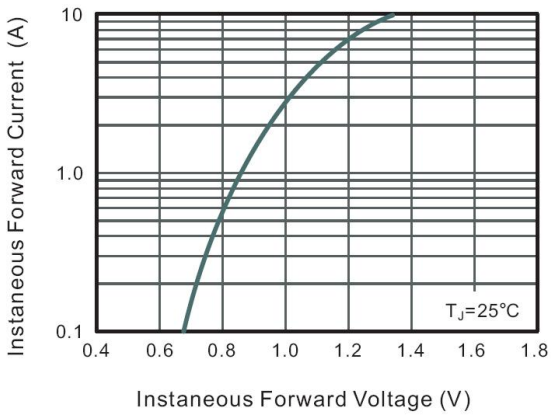
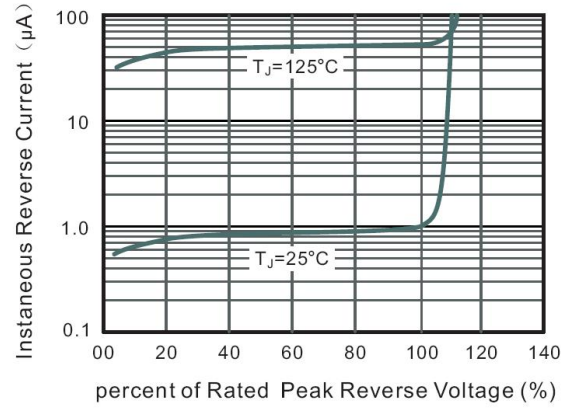
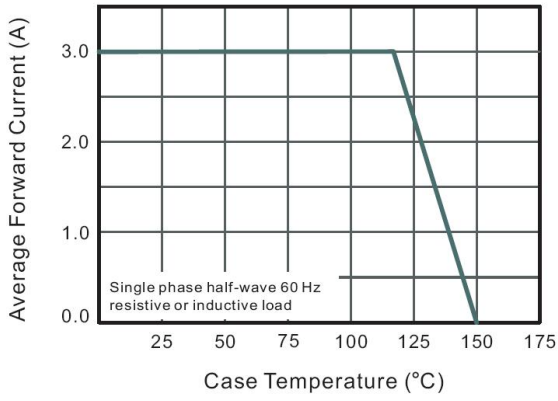

外形尺寸图 / Package Dimensions

SMBF

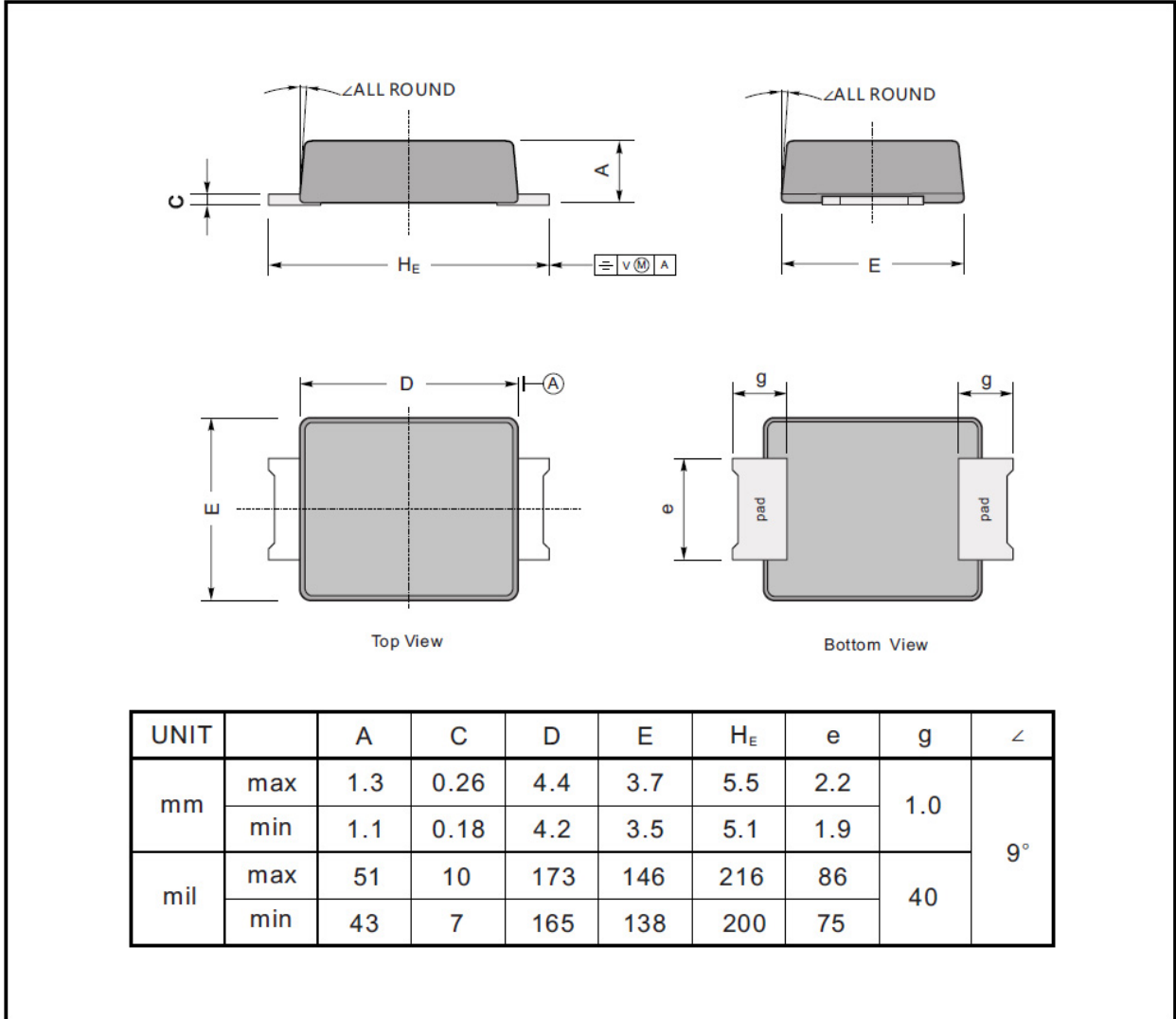

Marking

Type number	Marking code
S3ABF	S3AB
S3BBF	S3BB
S3DBF	S3DB
S3GBF	S3GB
S3JBF	S3JB
S3KBF	S3KB
S3MBF	S3MB

印章说明 / Marking Instructions

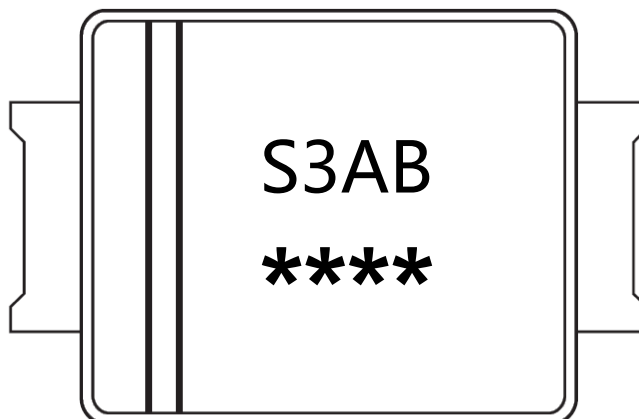

说明：

S3AB： 为型号代码

****： 为生产批号追溯码，第1个*为年月代码，后面3个*为当月小批号代码

Note:

S3AB： Product Type Code

****： Lot No. Code，The 1st * means:YM Code，The last 3 * means:little Lot No Code

回流焊温度曲线图(无铅) / Temperature Profile for IR Reflow Soldering(Pb-Free)

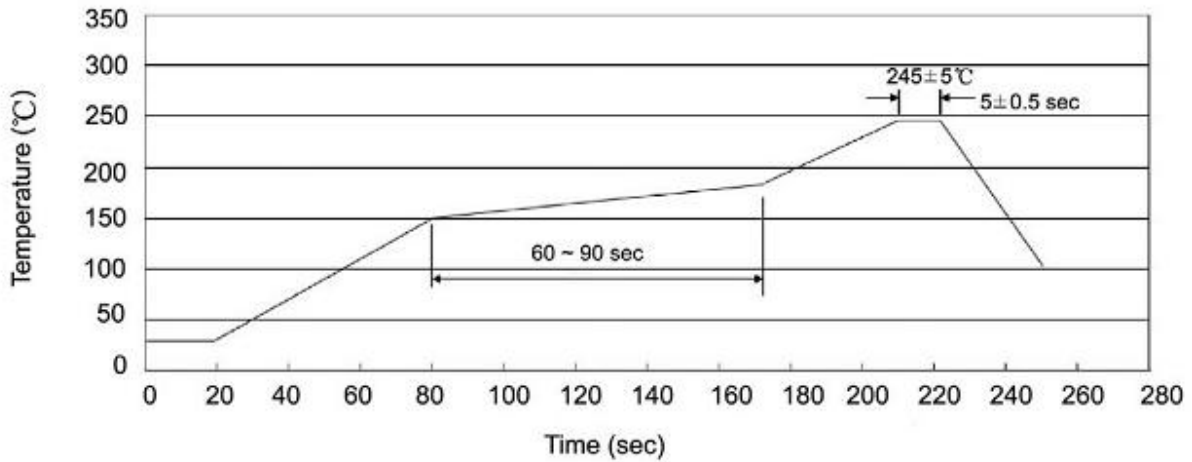

说明：

- 1、预热温度 150 ~ 180°C，时间 60 ~ 90sec;
- 2、峰值温度 245±5°C，时间持续为 5±0.5sec;
- 3、焊接制程冷却速度为 2 ~ 10°C/sec.

Note:

- 1.Preheating:150~180°C, Time:60~90sec.
- 2.Peak Temp.:245±5°C, Duration:5±0.5sec.
3. Cooling Speed: 2~10°C/sec.

耐焊接热试验条件 / Resistance to Soldering Heat Test Conditions

温度：260±5°C

时间：10±1 sec.

Temp.:260±5°C

Time:10±1 sec

包装规格 / Packaging SPEC.

卷盘包装 / REEL

Package Type 封装形式	Units 包装数量					Dimension 包装尺寸 (unit: mm ³)		
	Units/Reel 只/卷盘	Reels/Inner Box 卷盘/盒	Units/Inner Box 只/盒	Inner Boxes/Outer Box 盒/箱	Units/Outer Box 只/箱	Reel	Inner Box 盒	Outer Box 箱
SMBF	5000	2	10000	5	50000	13" ×15	336X332X40	380X335X366

使用说明 / Notices