

# SMF05

## ESD Protection Diode Array

### Quad, Low Clamping Voltage

This quad monolithic silicon overvoltage suppressor is designed for applications requiring transient voltage protection capability. It is intended for use in ESD sensitive equipment such as computers, printers, cell phones, medical equipment, and other applications. Its quad junction common anode design protects four separate lines using only one package. These devices are ideal for situations where board space is at a premium.

#### Specification Features

- SC-88A Package Allows Four Separate Unidirectional Configurations
- Low Leakage < 5  $\mu$ A @ 5 V
- Breakdown Voltage: 6.1 V – 7.2 V @ 1 mA
- Low Capacitance (90 pF TYP)
- Provides Protection for IEC61000-4-2
- Pb-Free Packages are Available\*

#### Mechanical Characteristics

- Void Free, Transfer-Molded, Thermosetting Plastic Case
- Corrosion Resistant Finish, Easily Solderable
- Package Designed for Optimal Automated Board Assembly
- Small Package Size for High Density Applications

#### Applications

- Computers
- Printers
- Cell Phones
- Medical Equipment



ON Semiconductor®

[www.onsemi.com](http://www.onsemi.com)

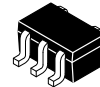

SC-88A/SOT-353  
CASE 419A-02  
STYLE 5  
SCALE 2:1

#### MARKING DIAGRAM

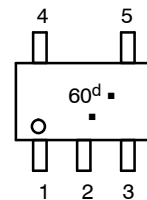

60 = Specific Device Code

<sup>d</sup> = Date Code

▪ = Pb-Free Package

(Note: Microdot may be in either location)

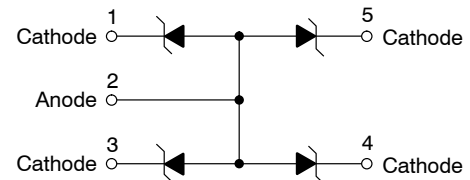

#### ORDERING INFORMATION

Device	Package	Shipping†
SMF05T1	SC-88A	3000 Tape & Reel
SMF05T1G	SC-88A (Pb-Free)	3000 Tape & Reel
SMF05T2G	SC-88A (Pb-Free)	3000 Tape & Reel
SMF05CT1	SC-88A	3000 Tape & Reel
SMF05CT1G	SC-88A (Pb-Free)	3000 Tape & Reel
SMF05CT2	SC-88A	3000 Tape & Reel
SMF05CT2G	SC-88A (Pb-Free)	3000 Tape & Reel

†For information on tape and reel specifications, including part orientation and tape sizes, please refer to our Tape and Reel Packaging Specification Brochure, BRD8011/D.

\*For additional information on our Pb-Free strategy and soldering details, please download the ON Semiconductor Soldering and Mounting Techniques Reference Manual, SOLDERRM/D.

# SMF05

## MAXIMUM RATINGS ( $T_A = 25^\circ\text{C}$ unless otherwise noted)

Characteristic	Symbol	Value	Unit
Peak Power Dissipation @ $8 \times 20 \mu\text{s}$ @ $T_A \leq 25^\circ\text{C}$ (Note 1)	$P_{pk}$	200	W
Maximum Junction Temperature	$T_{Jmax}$	150	$^\circ\text{C}$
Operating Junction and Storage Temperature Range	$T_J, T_{stg}$	-55 to +150	$^\circ\text{C}$
ESD Discharge IEC61000-4-2, Air Discharge IEC61000-4-2, Contact Discharge	$V_{pp}$	16 9	kV
Lead Solder Temperature (10 seconds duration)	$T_L$	260	$^\circ\text{C}$

Stresses exceeding those listed in the Maximum Ratings table may damage the device. If any of these limits are exceeded, device functionality should not be assumed, damage may occur and reliability may be affected.

1. Non-repetitive current per Figure 2. Derate per Figure 3.

## ELECTRICAL CHARACTERISTICS ( $T_A = 25^\circ\text{C}$ unless otherwise noted)

Device	Breakdown Voltage $V_{BR}$ @ 1 mA (Volts)		Leakage Current $I_R$ @ $V_{RWM} = 5 \text{ V}$ ( $\mu\text{A}$ )	Capacitance @ 0 V Bias ( $\text{pF}$ )	Max $V_F$ @ $I_F = 200 \text{ mA}$ (V)	Max Clamping Voltage ( $V_C$ ) @ $I_{PP}$		Max Clamping Voltage ( $V_C$ ) @ $I_{PP}$	
	Min	Max				$I_{PP}$ (A)	$V_C$ (V)	$I_{PP}$ (A)	$V_C$ (V)
SMF05	6.0	7.2	5.0	90	1.25	1.0	9.5	12	12.5

## TYPICAL PERFORMANCE CURVES

( $T_A = 25^\circ\text{C}$  unless otherwise noted)

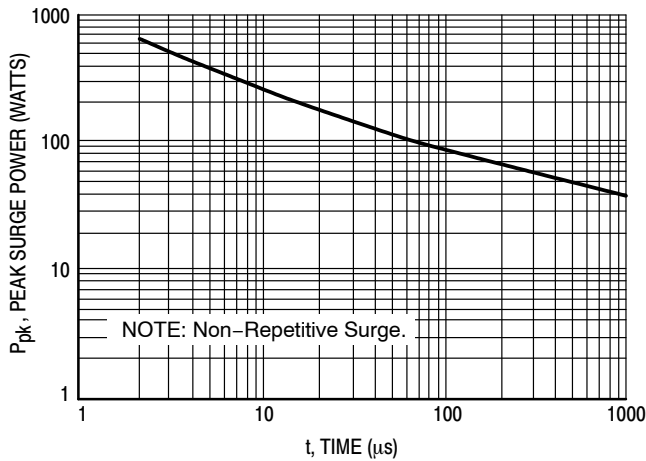

Figure 1. Peak Power Dissipation versus Pulse Width

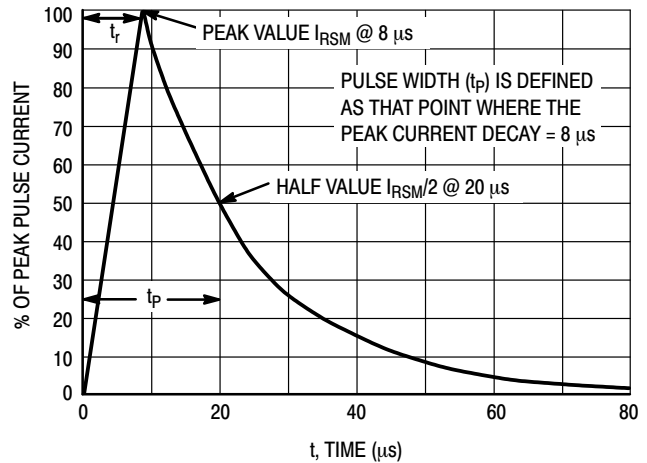
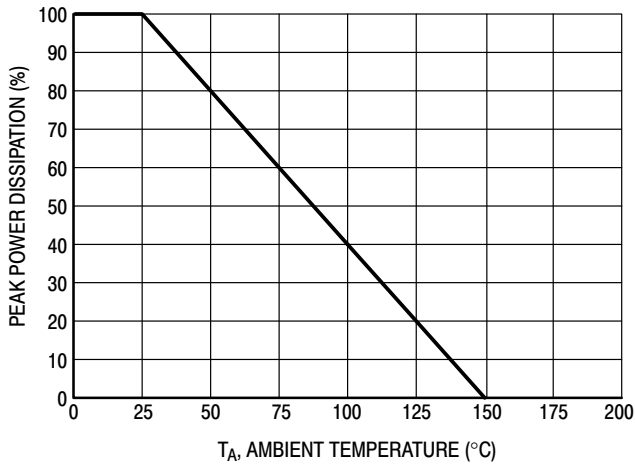

Figure 2. Pulse Waveform  $8 \times 20 \mu\text{s}$

# SMF05

## TYPICAL PERFORMANCE CURVES

( $T_A = 25^\circ\text{C}$  unless otherwise noted)



**Figure 3. Power Derating Curve**

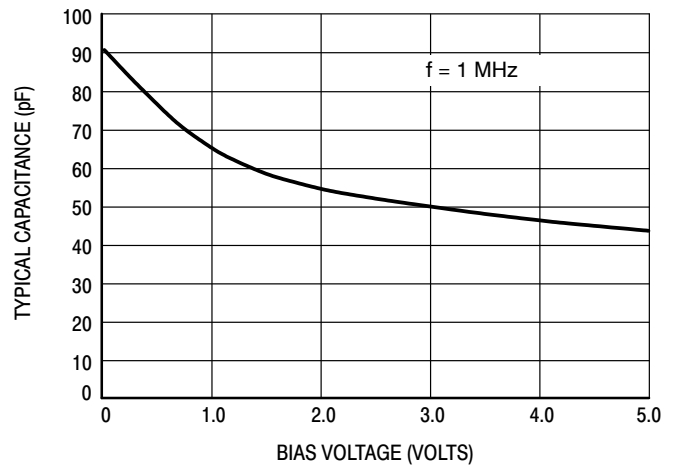

**Figure 4. Junction Capacitance versus Reverse Voltage**

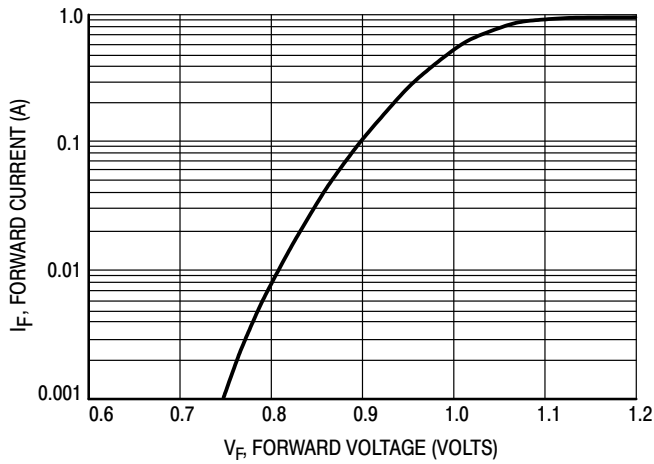

**Figure 5. Forward Voltage Curve**

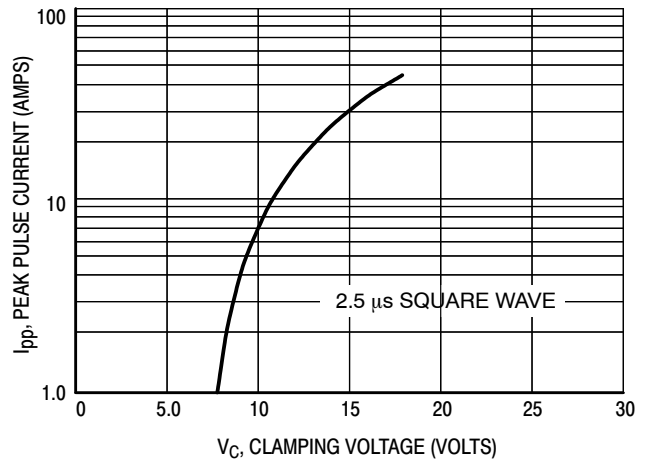

**Figure 6. Clamping Voltage versus Peak Pulse Current (Reverse Direction)**

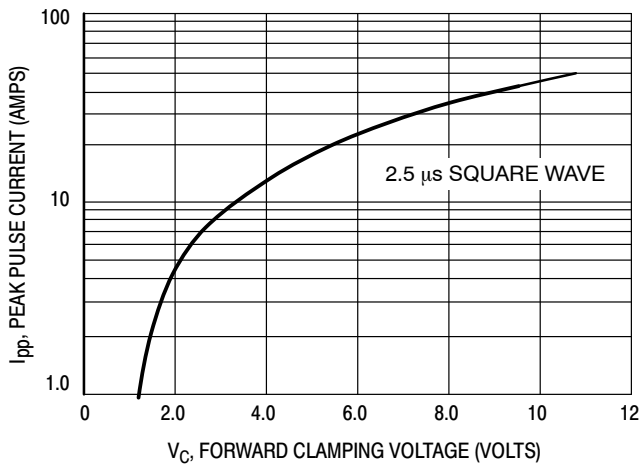

**Figure 7. Clamping Voltage versus Peak Pulse Current (Forward Direction)**

# MECHANICAL CASE OUTLINE PACKAGE DIMENSIONS



SCALE 2:1

## SC-88A (SC-70-5/SOT-353) CASE 419A-02 ISSUE M

DATE 11 APR 2023

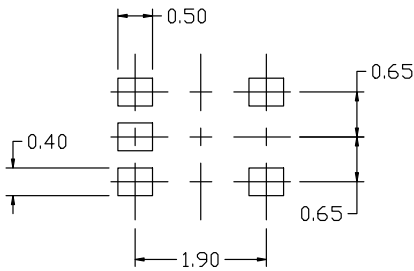
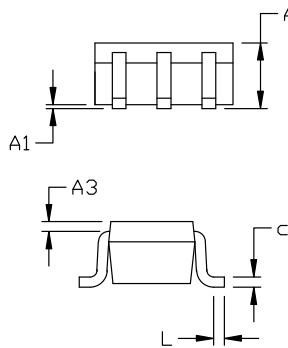
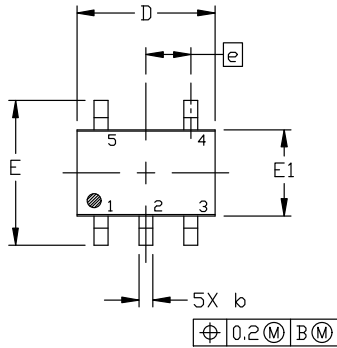

RECOMMENDED  
MOUNTING FOOTPRINT

\* For additional information on our Pb-Free strategy and soldering details, please download the ON Semiconductor Soldering and Mounting Techniques Reference Manual, SOLDERM/D.

### NOTES:

1. DIMENSIONING AND TOLERANCING PER ANSI Y14.5M, 1982.
2. CONTROLLING DIMENSION: MILLIMETERS
3. 419A-01 OBSOLETE. NEW STANDARD 419A-02
4. DIMENSIONS D AND E1 DO NOT INCLUDE MOLD FLASH, PROTRUSIONS, OR GATE BURRS. MOLD FLASH, PROTRUSIONS, OR GATE BURRS SHALL NOT EXCEED 0.1016MM PER SIDE.

DIM	MILLIMETERS		
	MIN.	NOM.	MAX.
A	0.80	0.95	1.10
A1	---	---	0.10
A3	0.20 REF		
b	0.10	0.20	0.30
c	0.10	---	0.25
D	1.80	2.00	2.20
E	2.00	2.10	2.20
E1	1.15	1.25	1.35
e	0.65 BSC		
L	0.10	0.15	0.30

### GENERIC MARKING DIAGRAM\*

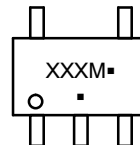

\*This information is generic. Please refer to device data sheet for actual part marking. Pb-Free indicator, "G" or microdot "▪", may or may not be present. Some products may not follow the Generic Marking.

XXX = Specific Device Code  
M = Date Code  
▪ = Pb-Free Package

(Note: Microdot may be in either location)

#### STYLE 1:

1. BASE
2. EMITTER
3. BASE
4. COLLECTOR
5. COLLECTOR

#### STYLE 2:

1. ANODE
2. EMITTER
3. BASE
4. COLLECTOR
5. CATHODE

#### STYLE 3:

1. ANODE 1
2. N/C
3. ANODE 2
4. CATHODE 2
5. CATHODE 1

#### STYLE 4:

1. SOURCE 1
2. DRAIN 1/2
3. SOURCE 1
4. GATE 1
5. GATE 2

#### STYLE 5:

1. CATHODE
2. COMMON ANODE
3. CATHODE 2
4. CATHODE 3
5. CATHODE 4

#### STYLE 6:

1. EMITTER 2
2. BASE 2
3. EMITTER 1
4. COLLECTOR
5. COLLECTOR 2/BASE 1

#### STYLE 7:

1. BASE
2. EMITTER
3. BASE
4. COLLECTOR
5. COLLECTOR

#### STYLE 8:

1. CATHODE
2. COLLECTOR
3. N/C
4. BASE
5. EMITTER

#### STYLE 9:

1. ANODE
2. CATHODE
3. ANODE
4. ANODE
5. ANODE

Note: Please refer to datasheet for style callout. If style type is not called out in the datasheet refer to the device datasheet pinout or pin assignment.

<b>DOCUMENT NUMBER:</b>	<b>98ASB42984B</b>	Electronic versions are uncontrolled except when accessed directly from the Document Repository. Printed versions are uncontrolled except when stamped "CONTROLLED COPY" in red.
<b>DESCRIPTION:</b>	<b>SC-88A (SC-70-5/SOT-353)</b>	<b>PAGE 1 OF 1</b>

onsemi and ONSEMI are trademarks of Semiconductor Components Industries, LLC dba onsemi or its subsidiaries in the United States and/or other countries. onsemi reserves the right to make changes without further notice to any products herein. onsemi makes no warranty, representation or guarantee regarding the suitability of its products for any particular purpose, nor does onsemi assume any liability arising out of the application or use of any product or circuit, and specifically disclaims any and all liability, including without limitation special, consequential or incidental damages. onsemi does not convey any license under its patent rights nor the rights of others.

**onsemi**, **Onsemi**, and other names, marks, and brands are registered and/or common law trademarks of Semiconductor Components Industries, LLC dba "**onsemi**" or its affiliates and/or subsidiaries in the United States and/or other countries. **onsemi** owns the rights to a number of patents, trademarks, copyrights, trade secrets, and other intellectual property. A listing of **onsemi**'s product/patent coverage may be accessed at [www.onsemi.com/site/pdf/Patent-Marking.pdf](http://www.onsemi.com/site/pdf/Patent-Marking.pdf). **onsemi** reserves the right to make changes at any time to any products or information herein, without notice. The information herein is provided "as-is" and **onsemi** makes no warranty, representation or guarantee regarding the accuracy of the information, product features, availability, functionality, or suitability of its products for any particular purpose, nor does **onsemi** assume any liability arising out of the application or use of any product or circuit, and specifically disclaims any and all liability, including without limitation special, consequential or incidental damages. Buyer is responsible for its products and applications using **onsemi** products, including compliance with all laws, regulations and safety requirements or standards, regardless of any support or applications information provided by **onsemi**. "Typical" parameters which may be provided in **onsemi** data sheets and/or specifications can and do vary in different applications and actual performance may vary over time. All operating parameters, including "Typicals" must be validated for each customer application by customer's technical experts. **onsemi** does not convey any license under any of its intellectual property rights nor the rights of others. **onsemi** products are not designed, intended, or authorized for use as a critical component in life support systems or any FDA Class 3 medical devices or medical devices with a same or similar classification in a foreign jurisdiction or any devices intended for implantation in the human body. Should Buyer purchase or use **onsemi** products for any such unintended or unauthorized application, Buyer shall indemnify and hold **onsemi** and its officers, employees, subsidiaries, affiliates, and distributors harmless against all claims, costs, damages, and expenses, and reasonable attorney fees arising out of, directly or indirectly, any claim of personal injury or death associated with such unintended or unauthorized use, even if such claim alleges that **onsemi** was negligent regarding the design or manufacture of the part. **onsemi** is an Equal Opportunity/Affirmative Action Employer. This literature is subject to all applicable copyright laws and is not for resale in any manner.

## ADDITIONAL INFORMATION

### TECHNICAL PUBLICATIONS:

Technical Library: [www.onsemi.com/design/resources/technical-documentation](http://www.onsemi.com/design/resources/technical-documentation)  
onsemi Website: [www.onsemi.com](http://www.onsemi.com)

### ONLINE SUPPORT: [www.onsemi.com/support](http://www.onsemi.com/support)

For additional information, please contact your local Sales Representative at [www.onsemi.com/support/sales](http://www.onsemi.com/support/sales)