

174966-2 ✓ ACTIVE

Multilock Connector System

TE Internal #: 174966-2

TE Internal Description: 040 MLC PLUG HSG 4P BLACK
MULTILOCK, CONNECTOR HOUSING

[View on TE.com >](#)

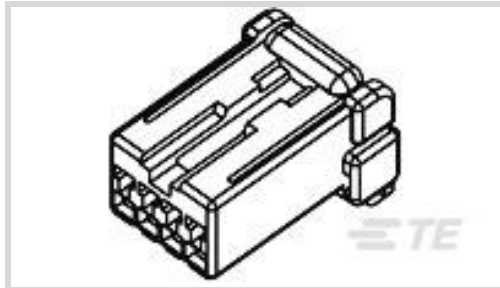

All MULTILOCK, CONNECTOR HOUSING (146)

Product Compliance

[For compliance documentation, visit the product page on TE.com>](#)

EU RoHS Directive 2011/65/EU	Compliant
EU ELV Directive 2000/53/EC	Compliant
China RoHS 2 Directive MIIT Order No 32, 2016	No Restricted Materials Above Threshold
EU REACH Regulation (EC) No. 1907/2006	Current ECHA Candidate List: JUNE 2024 (241) Candidate List Declared Against: JUNE 2024 (241) Does not contain REACH SVHC
Halogen Content	Low Halogen - Br, Cl, F, I < 900 ppm per homogenous material. Also BFR/CFR/PVC Free
Solder Process Capability	Not applicable for solder process capability

Product Compliance Disclaimer

This information is provided based on reasonable inquiry of our suppliers and represents our current actual knowledge based on the information they provided. This information is subject to change. The part numbers that TE has identified as EU RoHS compliant have a maximum concentration of 0.1% by weight in homogenous materials for lead, hexavalent chromium, mercury, PBB, PBDE, DBP, BBP, DEHP, DIBP, and 0.01% for cadmium, or qualify for an exemption to these limits as defined in the Annexes of Directive 2011/65/EU (RoHS2). Finished electrical and electronic equipment products will be CE marked as required by Directive 2011/65/EU. Components may not be CE marked. Additionally, the part numbers that TE has identified as EU ELV compliant have a maximum concentration of 0.1% by weight in homogenous materials for lead, hexavalent chromium, and mercury, and 0.01% for cadmium, or qualify for an exemption to these limits as defined in the Annexes of Directive 2000/53/EC (ELV). Regarding the REACH Regulation, the information TE provides on SVHC in articles for this part number is based on the latest European Chemicals Agency (ECHA) 'Guidance on requirements for substances in articles' posted at this URL: <https://echa.europa.eu/guidance-documents/guidance-on-reach>

Compatible Parts



Also in the Series | Multilock Connector System

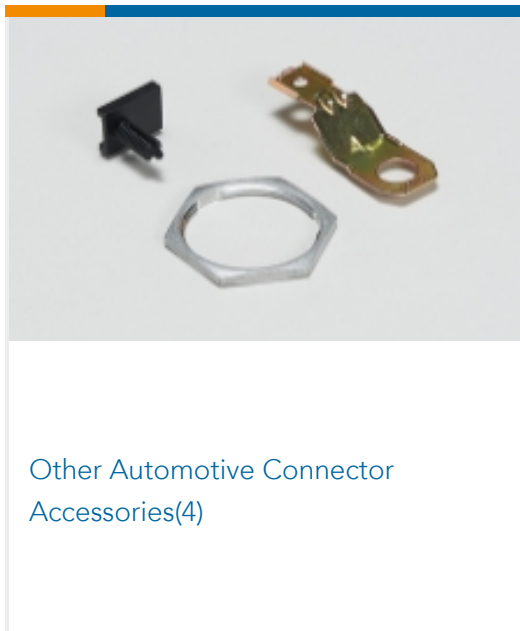
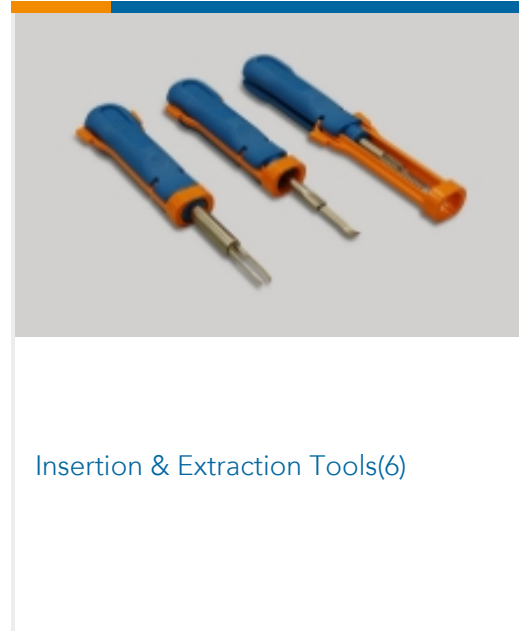
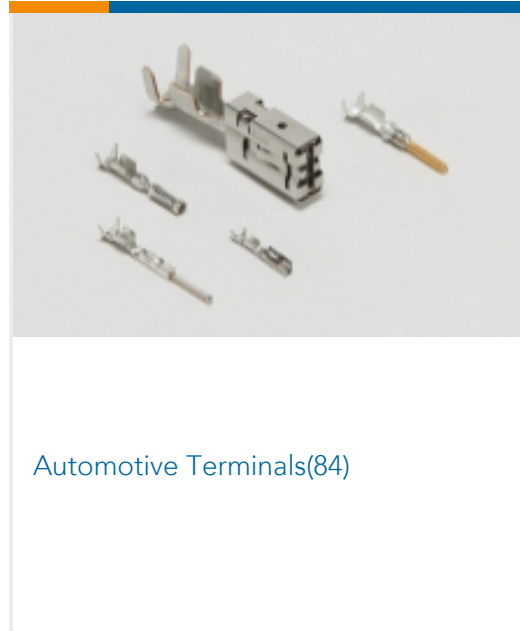
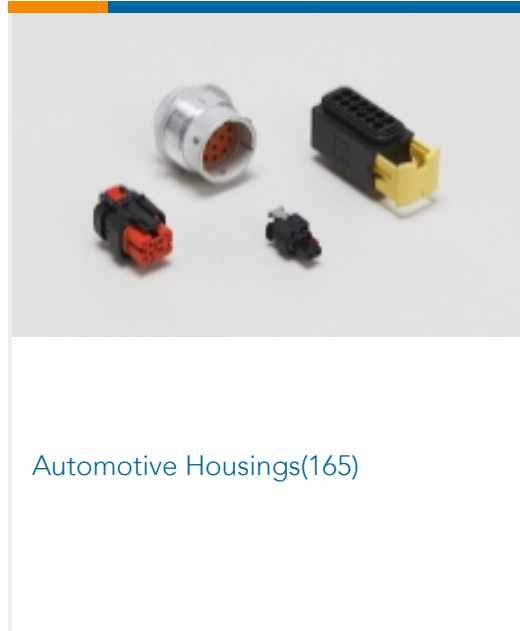
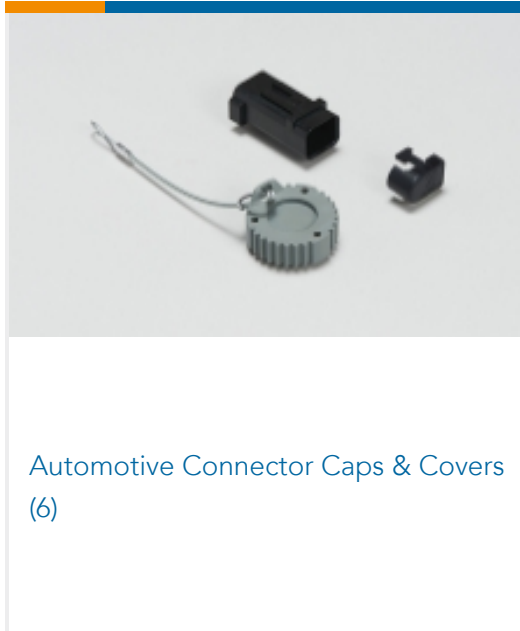

Customers Also Bought

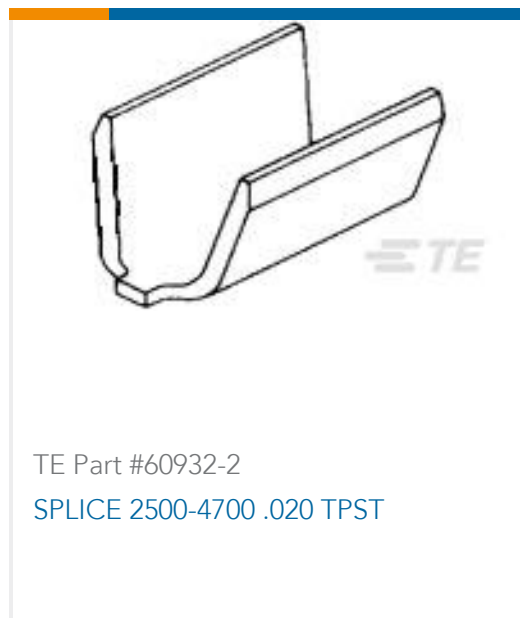



Documents

Product Drawings

[040 MLC PLUG HSG 4P BLACK](#)

English

CAD Files

[3D PDF](#)

English

[Customer View Model](#)

[ENG_CVM_174966-2_B.2d_dxf.zip](#)

English

[Customer View Model](#)

[ENG_CVM_174966-2_B.3d_igs.zip](#)

English

[Customer View Model](#)

[ENG_CVM_174966-2_B.3d_stp.zip](#)

English

By downloading the CAD file I accept and agree to the [Terms and Conditions](#) of use.

Datasheets & Catalog Pages

[MULTILOCK Connector System](#)

English

Product Specifications

[Crimping .040 Series, Receptacle Contact](#)

Japanese

[Application Specification](#)

Japanese

Instruction Sheets

[Instruction Sheet \(non U.S.\)](#)

English

[040 SERIES MULTI-LOCK CONNECTOR](#)

English