

100 V, precision, bidirectional current sense amplifier

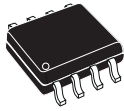

SO8



MiniSO8

Maturity status link

[TSC2020, TSC2021, TSC2022](#)

Features

- Wide common-mode voltage: -4 to 100 V
- High common-mode rejection CMR: 100 dB min.
- Offset voltage: $\pm 150 \mu\text{V}$ max.
- Offset drift: $0.5 \mu\text{V}/^\circ\text{C}$ max.
- Enhanced PWM rejection
- 2.7 to 5.5 V supply voltage
- Internal fixed gain
 - TSC2020: 20 V/V
 - TSC2021: 50 V/V
 - TSC2022: 100 V/V
- Gain error: 0.3% max.
- Gain drift: $3.5 \text{ ppm}/^\circ\text{C}$ max.
- SO8 and MiniSO8 package
- AEC-Q100 qualified

Applications

- High-side/low-side current sensing
- Battery management system
- 48 V power distribution
- 48 V power tools
- Motor control
- Automotive

Description

TSC2020, TSC2021 and TSC2022 are a series of precision bidirectional current sense amplifier. They can sense current via a shunt resistor over a wide range of common-mode voltages, from -4 to +100 V, whatever the supply voltage is. It is able to sense very low drop voltages, minimizing measurement error.

TSC2020, TSC2021 and TSC2022 are current sense amplifiers that may be used for various functions like precision current measurement, overcurrent protection, current monitoring, and feedback loops. These devices fully operate over the supply voltage range of 2.7 to 5.5 V, and over an ambient temperature range of -40 to 125 °C.

1 Block diagram and pin description

Figure 1. Block diagram

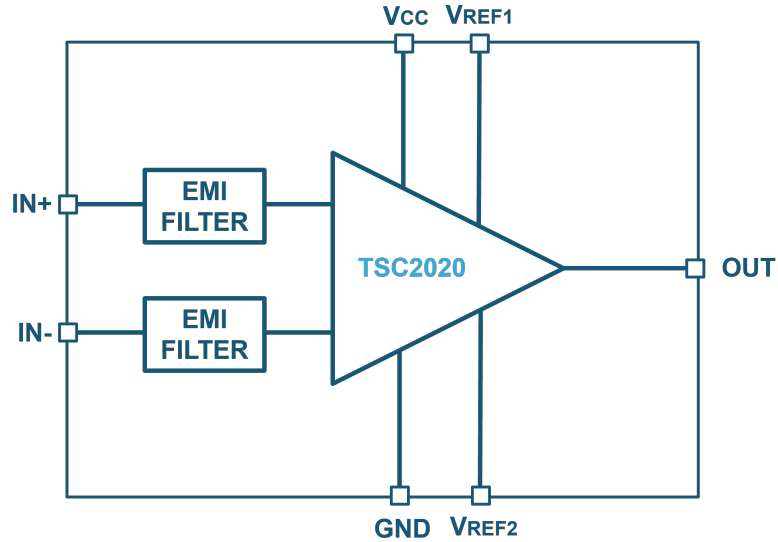

Figure 2. Pin connections (top view)

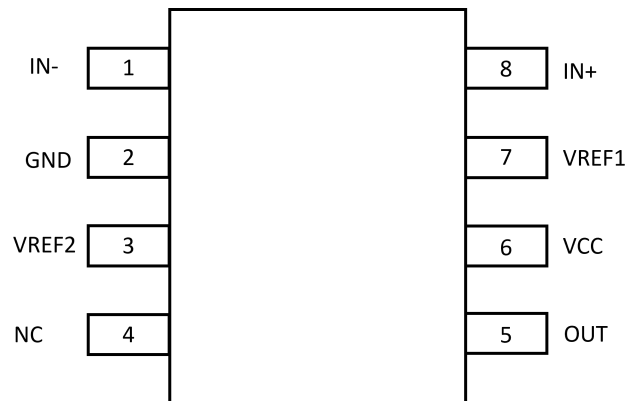

Table 1. Pin description

Pin	Pin name	Description
1	IN-	Negative input
2	GND	Ground
3	VREF2	Reference voltage 2
4	NC	Not connected
5	OUT	Output
6	VCC	Supply voltage
7	VREF1	Reference voltage 1
8	IN+	Positive input

2 Absolute maximum ratings and operation conditions

Table 2. Absolute maximum ratings

Symbol	Parameter	Value	Unit
V_{CC}	Supply voltage ⁽¹⁾	-0.3 to 5.8	V
V_{ICM}	Common-mode voltage on input pins	-10 to 105	V
V_{DIF}	Differential voltage between input pins (IN+, IN-)	±70	V
V_{REF1} , V_{REF2} , V_{OUT}	Voltage present on pins REF1, REF2, and OUT	GND - 0.3 to $V_{CC} + 0.3$	V
T_J	Junction temperature	150	°C
T_{STG}	Storage temperature	-65 to 150	°C
ESD	Human body model (HBM) ⁽²⁾	2000	V
	Charged device model (CDM) ⁽³⁾		
	SO8	750	V
	MiniSO8	1000	
R_{THJA}	Thermal resistance junction to ambient ⁽⁴⁾⁽⁵⁾		
	SO8	125	°C/W
	MiniSO8	190	

1. All voltage values, except the differential voltage, are with respect to the network ground terminal.
2. According to JEDEC standard JESD22-A114F.
3. According to ANSI/ESD STM 5.3.1.
4. Short-circuits can cause excessive heating and destructive dissipation.
5. The RTHs are typical values.

Table 3. Operating conditions

Symbol	Parameter	Value	Unit
V_{CC}	Supply voltage	2.7 to 5.5	V
V_{ICM}	Common-mode voltage on input pins	-4 to +100	V
V_{REF}	Output offset adjustment range	0 to V_{CC}	V
T	Operating free-air temperature range	-40 to 125	°C

3 Electrical characteristics

Table 4. Electrical characteristics - $V_{CC} = 2.7\text{ V}$, $V_{ICM} = 48\text{ V}$, $T = 25\text{ °C}$ (unless otherwise specified).

Symbol	Parameter	Conditions	Min.	Typ.	Max.	Unit
Power supply						
I_{CC}	Current consumption	$V_{ICM} = -4\text{ to }100\text{ V}$ $T_{min} < T < T_{max}$		1.7	2.3 2.3	mA
Input						
$ V_{OS} $	Offset voltage (RTI) ⁽¹⁾	$V_{ICM} = 12\text{ V}$, $V_{REF} = 1.35\text{ V}$ $T_{min} < T < T_{max}$			150 200	μV
		$V_{ICM} = 48\text{ V}$, $V_{REF} = 1.35\text{ V}$ $T_{min} < T < T_{max}$			400 500	
$ \Delta V_{OS}/\Delta T $	Offset drift vs. temperature	$V_{ICM} = 12\text{ V}$, $T_{min} < T < T_{max}$			0.5	$\mu\text{V}/\text{°C}$
		$V_{ICM} = 48\text{ V}$, $T_{min} < T < T_{max}$			1	
CMR	Common-mode rejection	$V_{ICM} = -4\text{ to }100\text{ V}$, DC mode $T_{min} < T < T_{max}$	100 100	112		dB
I_{IB}	Input bias current	$V_{ICM} = 12\text{ V}$, $V_{sense} = 0$ $T_{min} < T < T_{max}$		100	130 140	μA
		$V_{ICM} = 48\text{ V}$, $V_{sense} = 0$ $T_{min} < T < T_{max}$		200	230 240	
$ V_{sense} $	V_{sense} operating range with $E_g \leq 0.3\%$ ⁽²⁾	TSC2020 $T_{min} < T < T_{max}$			123.8 123.6	mV
		TSC2021 $T_{min} < T < T_{max}$			49.1 48.8	
		TSC2022 $T_{min} < T < T_{max}$			24.1 23.9	
Output						
G	Gain	TSC2020 TSC2021 TSC2022		20 50 100		V/V
E_g	Gain error	$\Delta V_{OUT} = 100\text{ mV to } (V_{CC} - 100\text{ mV})$ $T_{min} < T < T_{max}$		0.01	0.3 0.35	%
$\Delta E_g/\Delta T$	Gain error drift	$T_{min} < T < T_{max}$			3.5	ppm/°C
NLE	Linearity error	$V_{ICM} = -4\text{ to }100\text{ V}$		0.01		%
$V_{CC} - V_{OH}$	Drop voltage output high	$I_{source} = 0.2\text{ mA}$ $T_{min} < T < T_{max}$		11	25 35	mV
		$I_{source} = 2\text{ mA}$ $T_{min} < T < T_{max}$		115	150 200	
V_{OL}	Output voltage low	$I_{sink} = 0.2\text{ mA}$ $T_{min} < T < T_{max}$		24	40 55	mV
		$I_{sink} = 2\text{ mA}$ $T_{min} < T < T_{max}$		200	240 390	

Symbol	Parameter	Conditions	Min.	Typ.	Max.	Unit
I _{OUT}	Output current	Sink mode	8	12.5	18	mA
		T _{min} < T < T _{max}	5		24	
		Source mode	10	14.5	25	
		T _{min} < T < T _{max}	5		30	
Reg Load	Load regulation	I _{OUT} = -5 to +5 mA		0.2	1.5	$\frac{mV}{mA}$
C _L	Maximum capacitive load	No sustained oscillation		1		nF
Offset adjustment						
RT	V _{REF} gain	OUT/V _{REF} gain for either V _{REF} pin		0.5		V/V
Acc	Accuracy, RT	One V _{REF} pin connected to V _{CC} , the other to GND		0.2		%
Dynamic performances						
BW	Small signal -3 dB bandwidth	R _L = 10 kΩ, C _L = 100 pF	350	650		kHz
		T _{min} < T < T _{max}	350			
SR	Slew rate	C _L = 100 pF				V/μs
		TSC2020, V _{sense} = 108 mV	1.1	1.8		
		TSC2020, T _{min} < T < T _{max}	1			
		TSC2021, V _{sense} = 43 mV	1.5	2.4		
		TSC2021, T _{min} < T < T _{max}	1.4			
		TSC2022, V _{sense} = 22 mV	1.9	3		
		TSC2022, T _{min} < T < T _{max}	1.8			
E _N	Spectral density (RTI) ⁽¹⁾	f = 1 kHz		63		nV/√Hz

1. RTI stands for "Related to input."

2. V_{sense} = (V_{in+}) - (V_{in-}).

Table 5. Electrical characteristics - $V_{CC} = 5\text{ V}$, $V_{ICM} = 48\text{ V}$, $T = 25\text{ }^{\circ}\text{C}$ (unless otherwise specified).

Symbol	Parameter	Conditions	Min.	Typ.	Max.	Unit
Power supply						
I_{CC}	Current consumption	$V_{ICM} = -4\text{ to }100\text{ V}$ $T_{min} < T < T_{max}$		1.8	2.4 2.4	mA
Input						
$ V_{os} $	Offset voltage (RTI) ⁽¹⁾	$V_{ICM} = 12\text{ V}$, $V_{REF} = 2.5\text{ V}$ $T_{min} < T < T_{max}$			150 200	μV
		$V_{ICM} = 48\text{ V}$, $V_{REF} = 2.5\text{ V}$ $T_{min} < T < T_{max}$			400 500	
$ \Delta V_{os}/\Delta T $	Offset drift vs. temperature	$V_{ICM} = 12\text{ V}$, $T_{min} < T < T_{max}$			0.5	$\mu\text{V}/^{\circ}\text{C}$
		$V_{ICM} = 48\text{ V}$, $T_{min} < T < T_{max}$			1	
CMR	Common-mode rejection	$V_{ICM} = -4\text{ to }100\text{ V}$, DC mode $T_{min} < T < T_{max}$	100 100	112		dB
SVR	Supply voltage rejection	$V_{CC} = 2.7\text{ to }5.5\text{ V}$ $T_{min} < T < T_{max}$	100 100	118		dB
I_{IB}	Input bias current	$V_{ICM} = 12\text{ V}$, $V_{sense} = 0$ $T_{min} < T < T_{max}$		100	130 140	μA
		$V_{ICM} = 48\text{ V}$, $V_{sense} = 0$ $T_{min} < T < T_{max}$		200	230 240	
V_{sense}	V_{sense} operating range with $E_g \leq 0.3\%$ ⁽²⁾	TSC2020 $T_{min} < T < T_{max}$			238.5 238.2	mV
		TSC2021 $T_{min} < T < T_{max}$			94.9 94.7	
		TSC2022 $T_{min} < T < T_{max}$			47.1 46.8	
Output						
G	Gain	TSC2020 TSC2021 TSC2022		20 50 100		V/V
E_g	Gain error	$\Delta V_{OUT} = 100\text{ mV to } (V_{CC} - 100\text{ mV})$ $T_{min} < T < T_{max}$		0.01	0.3 0.35	%
$\Delta E_g/\Delta T$	Gain error drift	$T_{min} < T < T_{max}$			3.5	ppm/ $^{\circ}\text{C}$
NLE	Linearity error	$V_{ICM} = -4\text{ to }100\text{ V}$		0.01		%
$V_{CC} - V_{OH}$	Drop voltage output	$I_{source} = 0.2\text{ mA}$ $T_{min} < T < T_{max}$		18	35 45	mV
		$I_{source} = 2\text{ mA}$ $T_{min} < T < T_{max}$		122	155 210	
V_{OL}	Output voltage low	$I_{sink} = 0.2\text{ mA}$ $T_{min} < T < T_{max}$		35	50 70	mV
		$I_{sink} = 2\text{ mA}$ $T_{min} < T < T_{max}$		217	250 400	

Symbol	Parameter	Conditions	Min.	Typ.	Max.	Unit
I _{OUT}	Output current	Sink mode	8	13.5	20	mA
		T _{min} < T < T _{max}	5		24	
		Source mode	10	14.5	25	
		T _{min} < T < T _{max}	5		30	
Reg load	Load regulation	I _{OUT} = -5 to +5 mA		0.2	1.5	$\frac{mV}{mA}$
Offset adjustment						
RT	V _{REF} gain	OUT/V _{REF} gain for either V _{REF} pin		0.5		V/V
Acc	Accuracy, RT	One V _{REF} pin connected to V _{CC} , the other to GND		0.2		%
Dynamic performances						
BW	Small signal -3 dB bandwidth	R _L = 10 kΩ, C _L = 100 pF	450	700		kHz
		T _{min} < T < T _{max}	450			
SR	Slew rate	C _L = 100 pF				V/μs
		TSC2020, V _{sense} = 200 mV	1.4	2		
		TSC2020, T _{min} < T < T _{max}	1.2			
		TSC2021, V _{sense} = 80 mV	1.7	2.8		
		TSC2021, T _{min} < T < T _{max}	1.6			
		TSC2022, V _{sense} = 40 mV	2.4	3.9		
EN	Spectral density (RTI) ⁽¹⁾	f = 1 kHz		53		nV/√Hz

1. RTI stands for "Related to input."

2. V_{sense} = (V_{in+}) - (V_{in-}).

4 Typical characteristics

TSC2020 is used for typical characteristics, unless otherwise specified.

Figure 3. Input offset production distribution

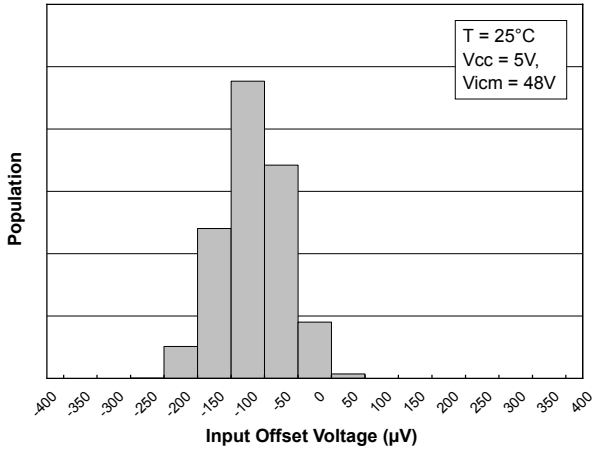

Figure 4. Gain error production distribution

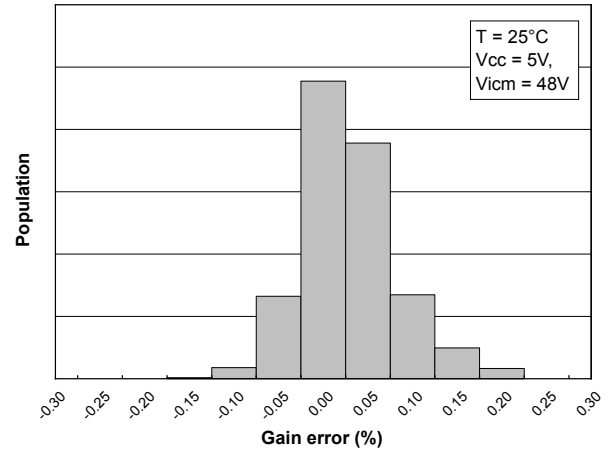

Figure 5. Common-mode rejection ratio production distribution

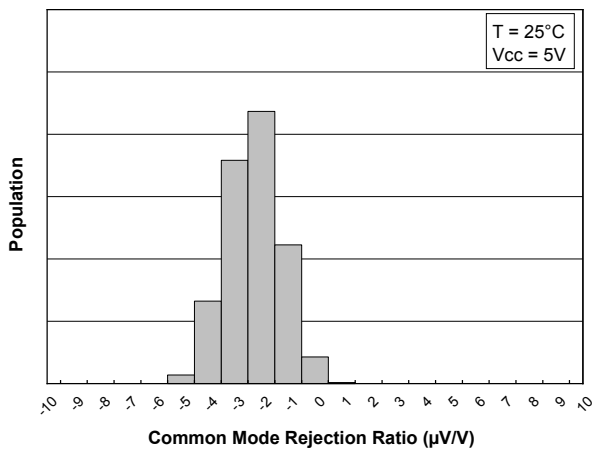

Figure 6. Supply current vs. supply voltage

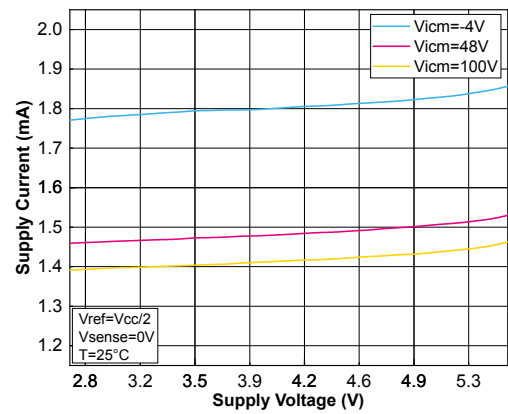

Figure 7. Supply current vs. input common-mode

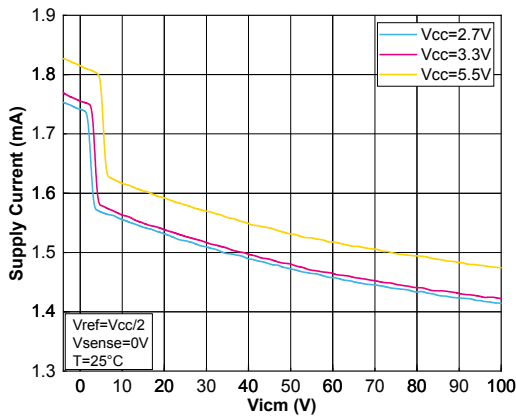

Figure 8. Supply current vs. temperature

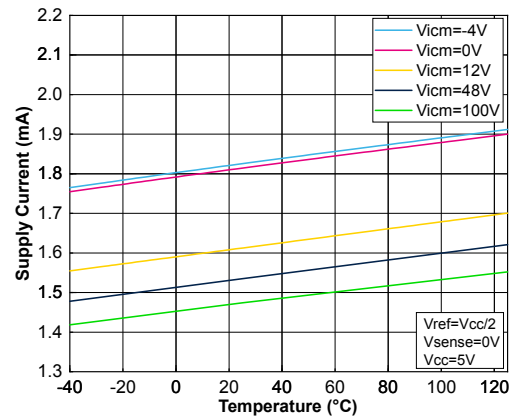

Figure 9. Input bias current vs. input common-mode

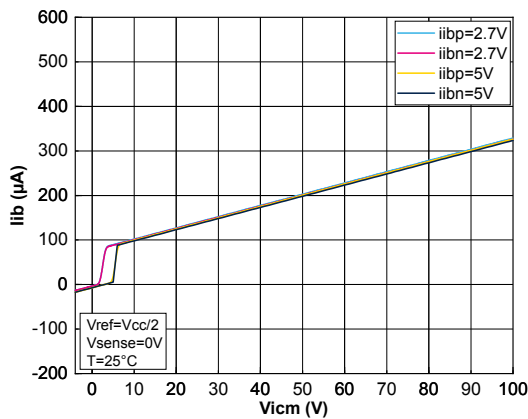

Figure 10. Input bias current vs. temperature

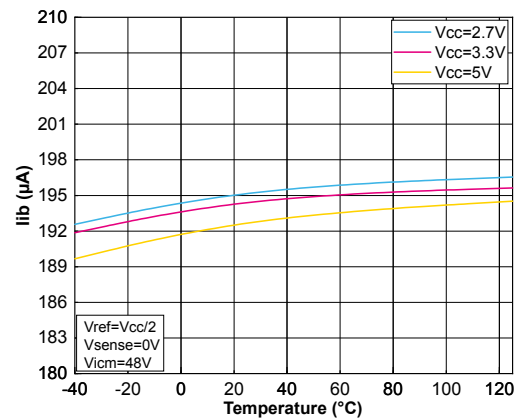

Figure 11. Input bias current vs. input common-mode

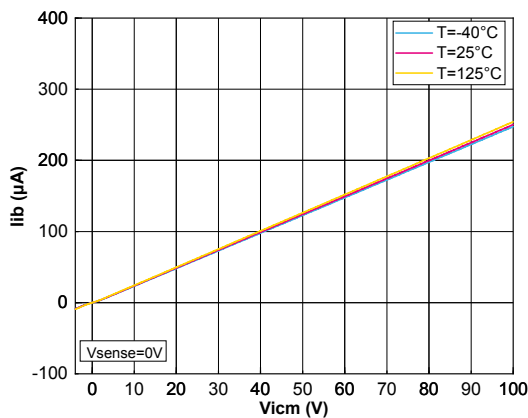

Figure 12. Input bias current vs. Vsense

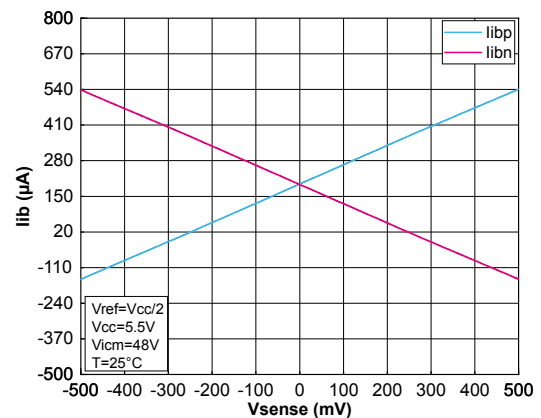

Figure 13. Input offset voltage vs. temperature

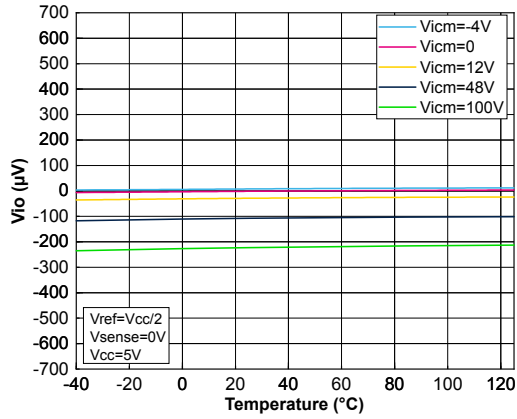

Figure 14. Input offset voltage vs. input common-mode with $V_{CC} = 5.5 V$

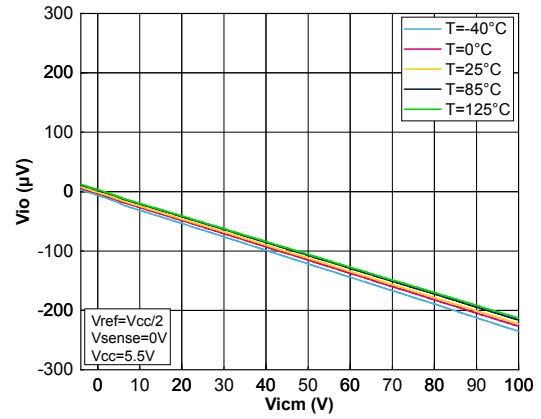

Figure 15. Input offset voltage vs. input common-mode with $V_{CC} = 2.7 V$

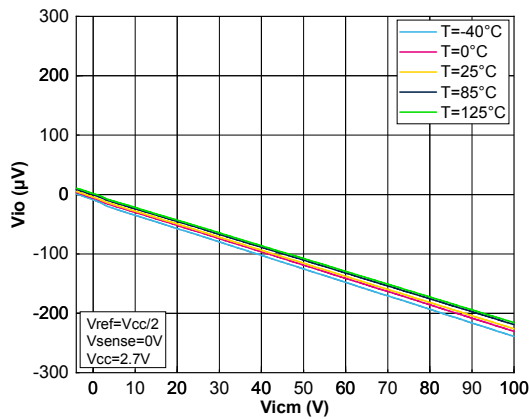

Figure 16. Input offset voltage vs. supply voltage

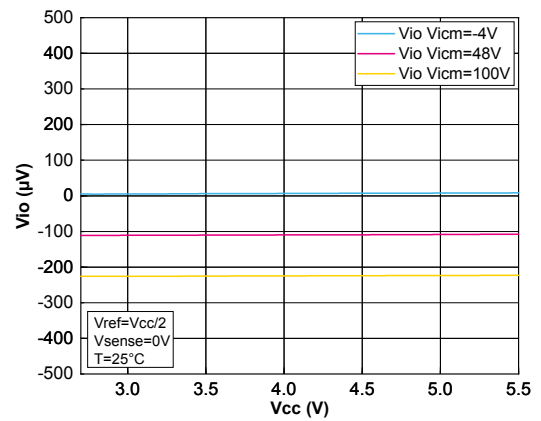

Figure 17. Output current vs. output voltage

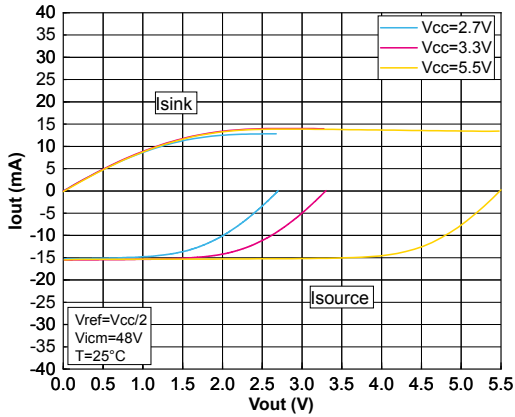

Figure 18. Output current vs. temperature with $V_{CC} = 5.5\text{ V}$

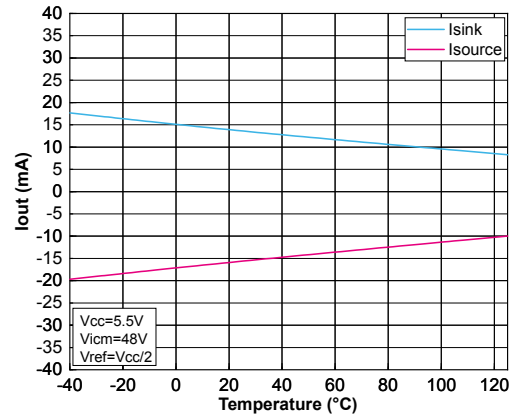

Figure 19. Output current vs. temperature with $V_{CC} = 2.7\text{ V}$

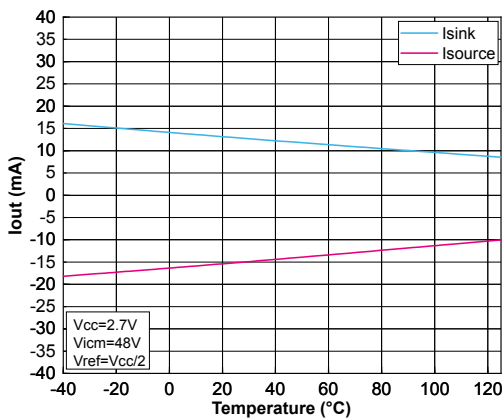

Figure 20. V_{OH} and V_{OL} vs. temperature with $V_{CC} = 5.5\text{ V}$

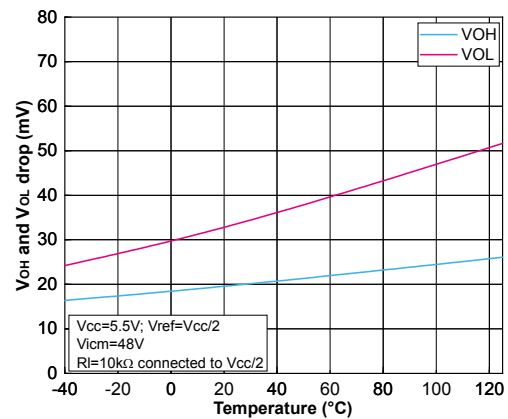

Figure 21. V_{OH} and V_{OL} vs. temperature with $V_{CC} = 2.7\text{ V}$

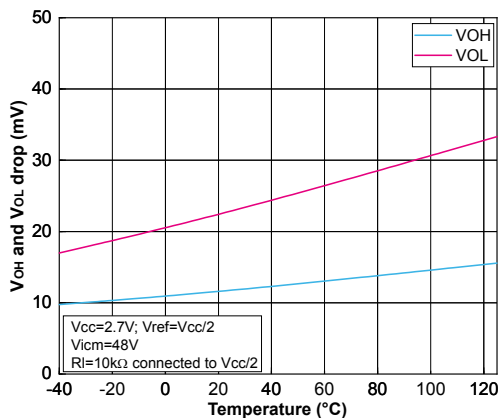

Figure 22. Linearity vs. V_{sense} with $V_{CC} = 5.5\text{ V}$

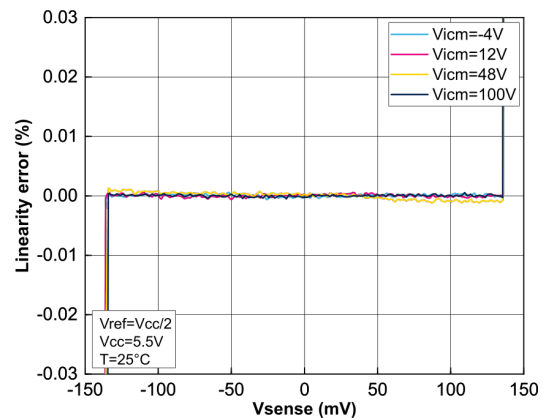

Figure 23. Linearity vs. Vsense

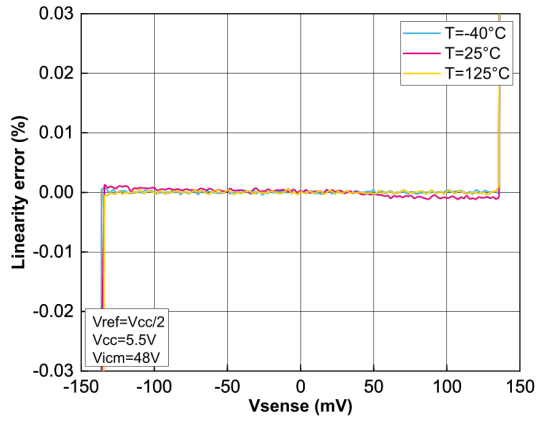

Figure 24. Gain error vs. input common-mode different Vcc

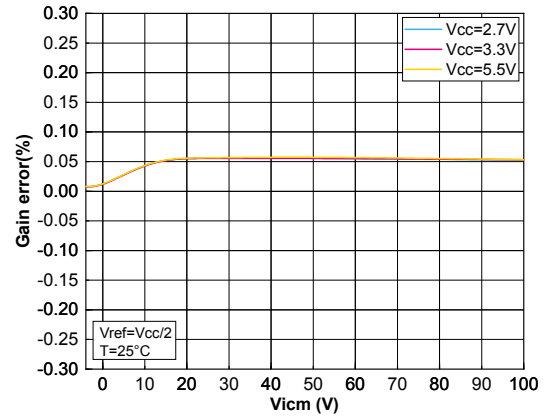

Figure 25. Gain error vs. input common-mode voltage different temperature

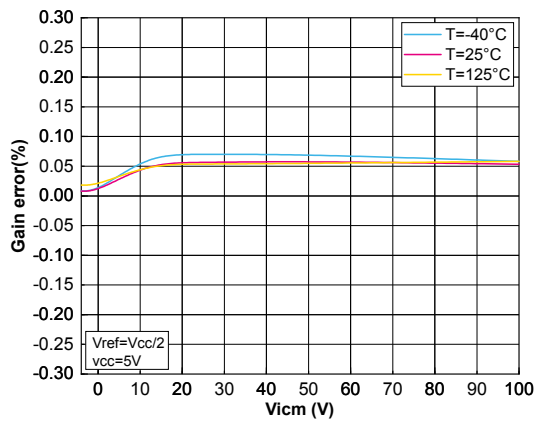

Figure 26. Load regulation with VCC = 5 V

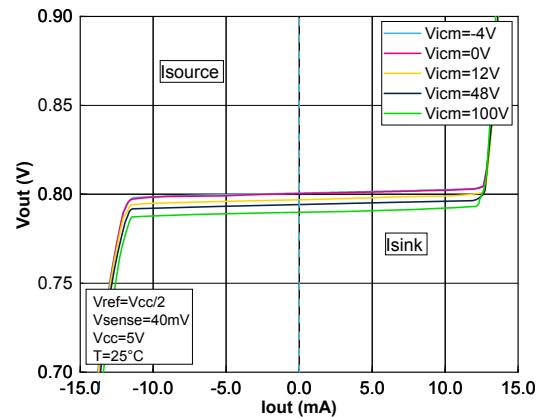

Figure 27. Gain vs. frequency

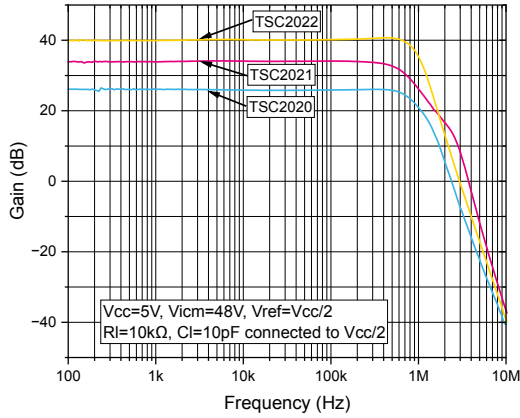

Figure 28. Gain vs. frequency with different capacitive load

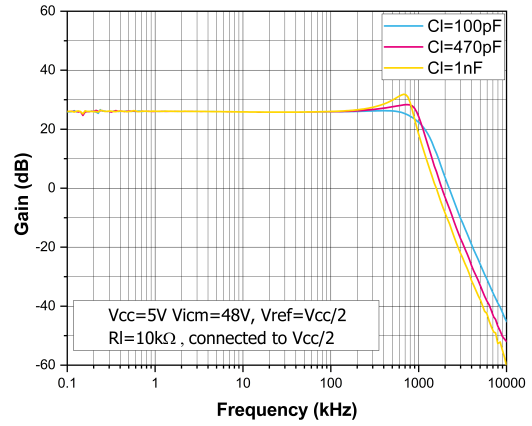

Figure 29. Gain vs. frequency with different capacitive load (TSC2021)

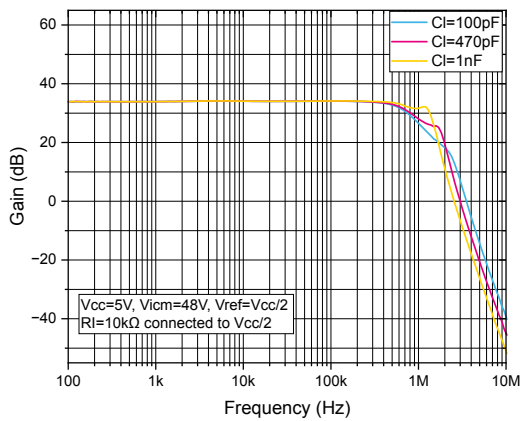

Figure 30. Gain vs. frequency with different capacitive load (TSC2022)

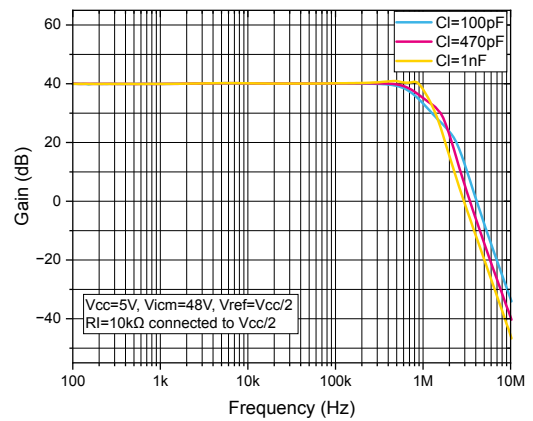

Figure 31. Bandwidth vs. input common-mode

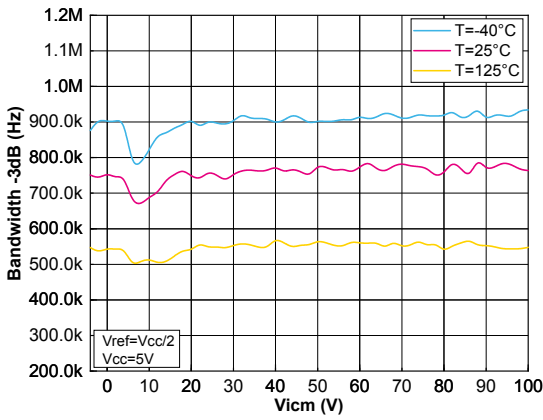

Figure 32. Overshoot vs. capacitive load

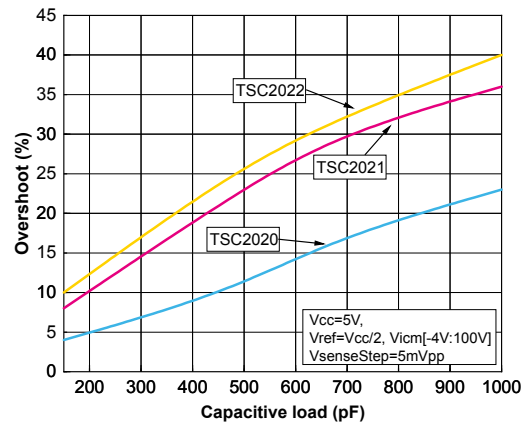

Figure 33. Small signal response with $V_{CC} = 5\text{ V}$

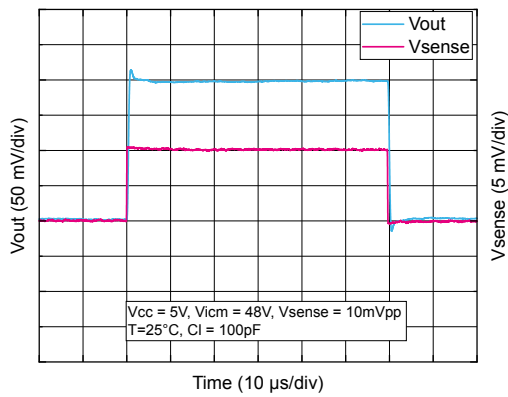

Figure 34. Large signal response with $V_{CC} = 5\text{ V}$

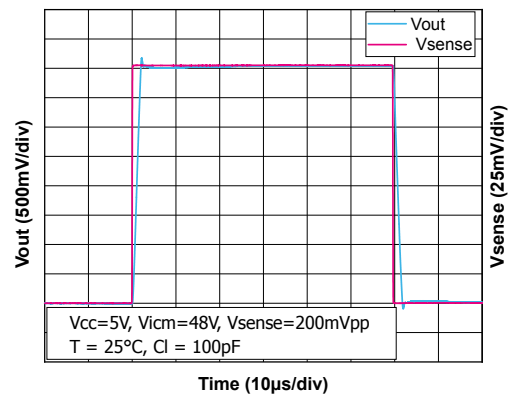

Figure 35. Large signal response with $V_{CC} = 5\text{ V}$
(TSC2021)

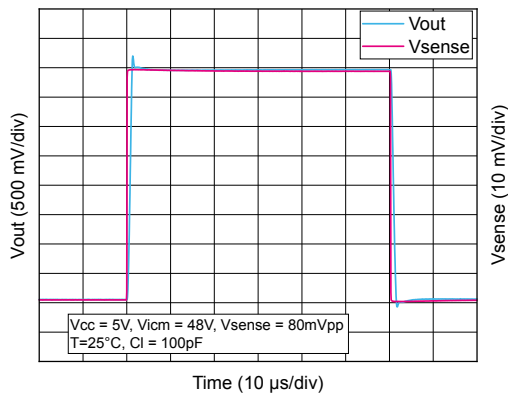

Figure 36. Large signal response with $V_{CC} = 5\text{ V}$
(TSC2022)

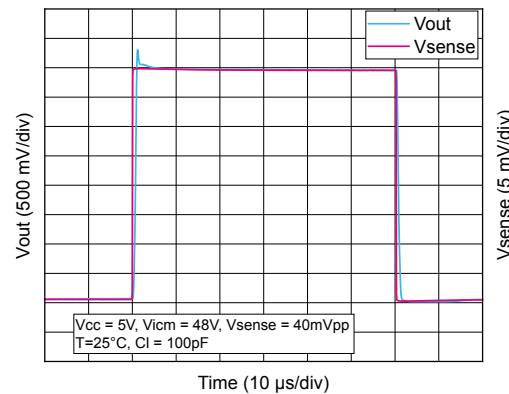

Figure 37. Positive settling time 1% vs. input common-mode

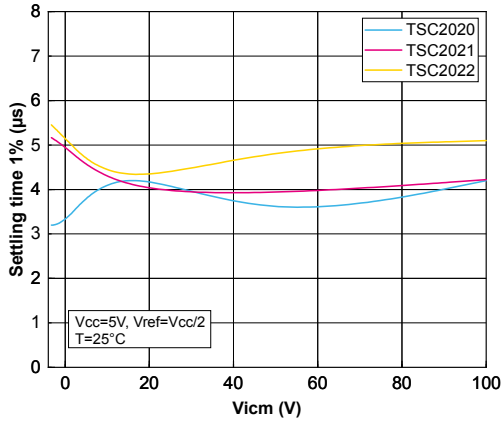

Figure 38. Negative settling time 1% vs. input common-mode

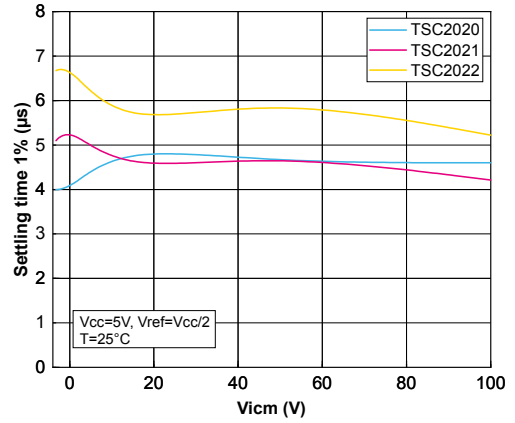

Figure 39. 48 V common-mode positive step response recovery

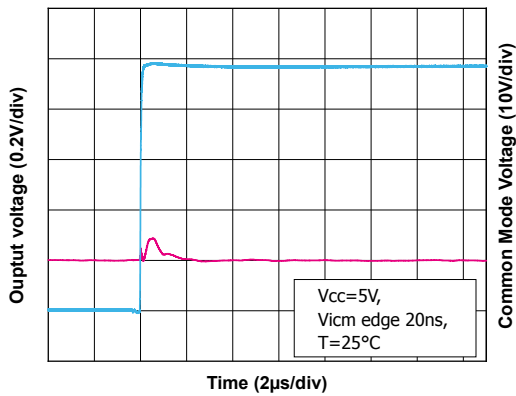

Figure 40. 48 V common-mode negative step response recovery

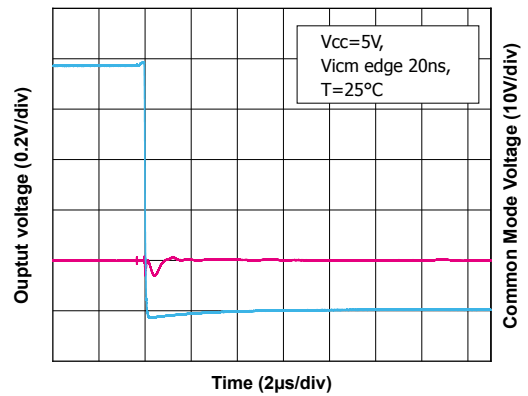

Figure 41. 100 V common-mode positive step response recovery

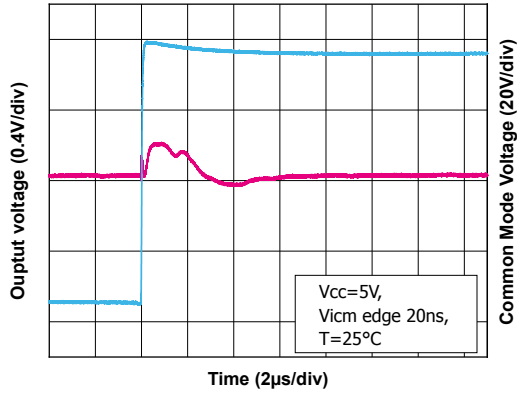

Figure 42. 100 V common-mode negative step response recovery

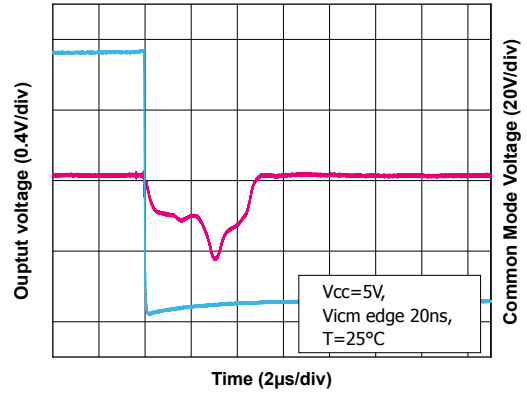

Figure 43. PSRR vs. frequency

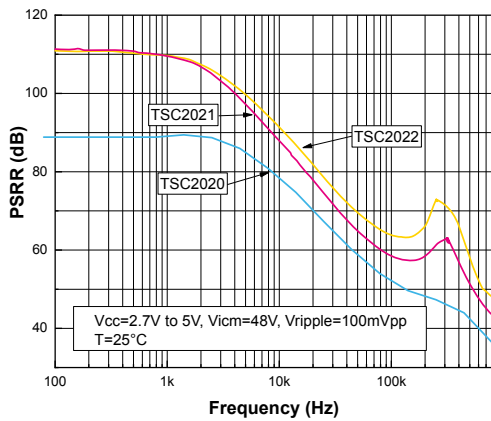

Figure 44. CMRR vs. frequency

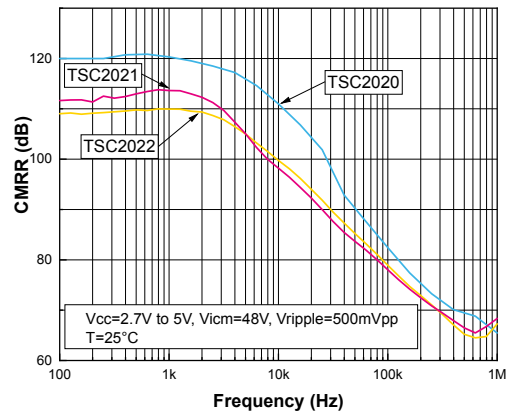

Figure 45. Positive overvoltage recovery

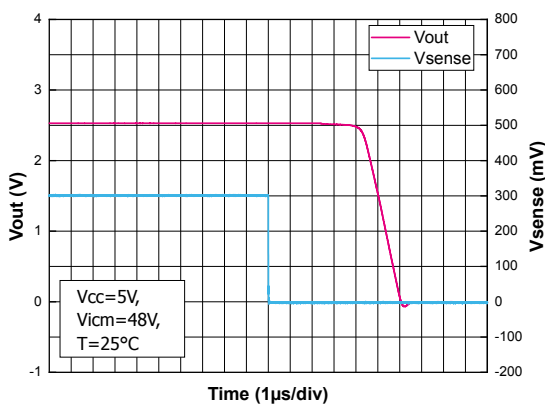

Figure 46. Negative overvoltage recovery

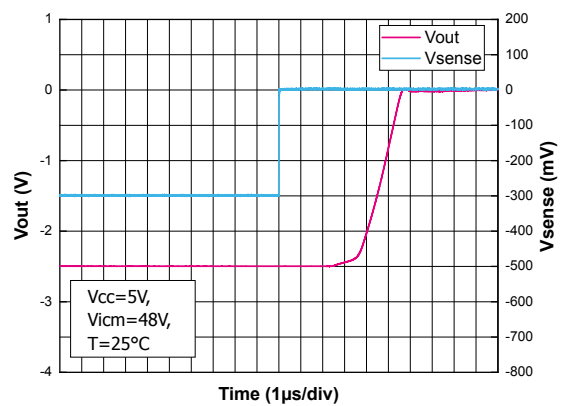

Figure 47. Overvoltage recovery vs input common-mode, $V_{CC} = 5\text{ V}$

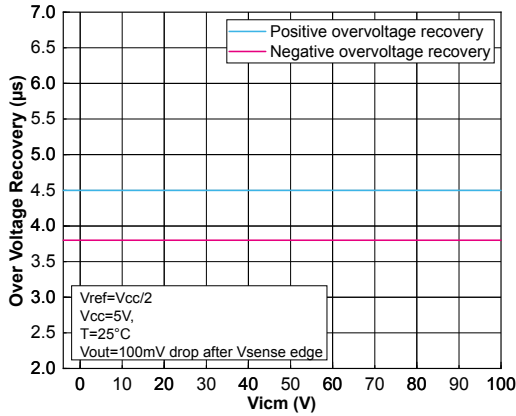

Figure 48. Noise vs. frequency

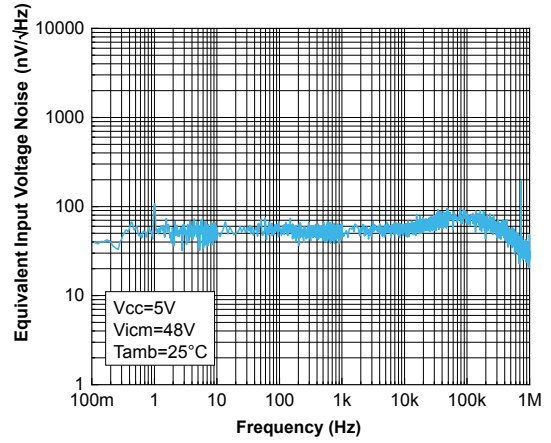

Figure 49. 0.1 Hz to 10 Hz voltage noise

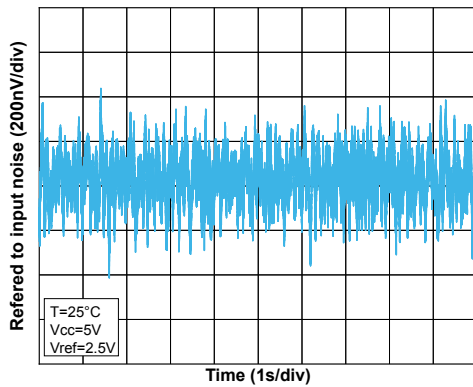

Figure 50. Power up time delay

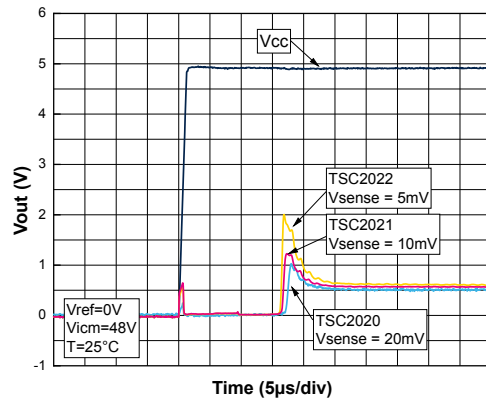
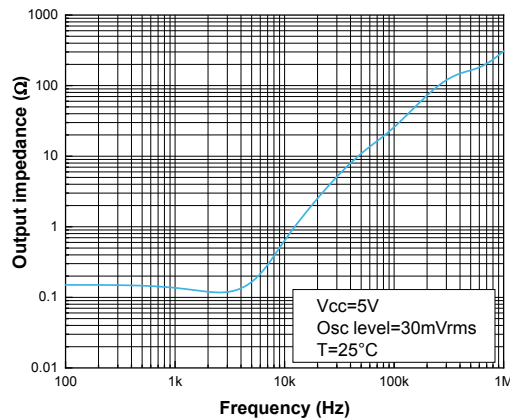

Figure 51. Output impedance vs. frequency



5 Package information

In order to meet environmental requirements, ST offers these devices in different grades of **ECOPACK** packages, depending on their level of environmental compliance. ECOPACK specifications, grade definitions and product status are available at: www.st.com. ECOPACK is an ST trademark.

5.1 SO8 package information

Figure 52. SO8 package outline

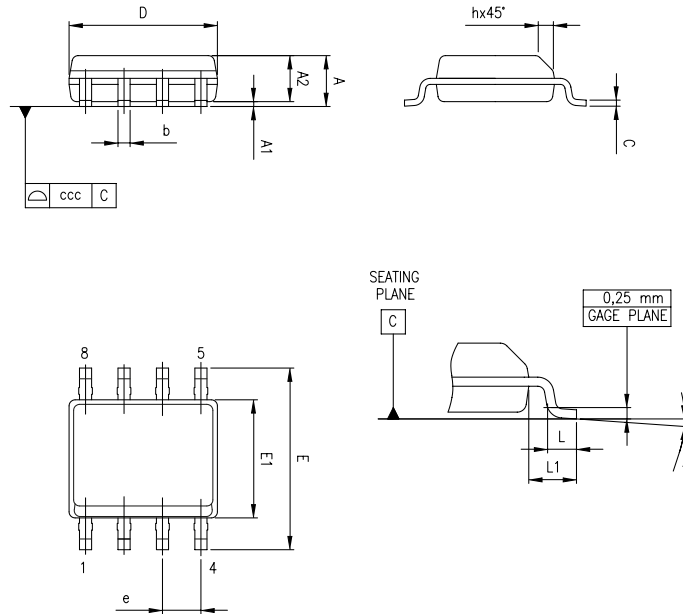
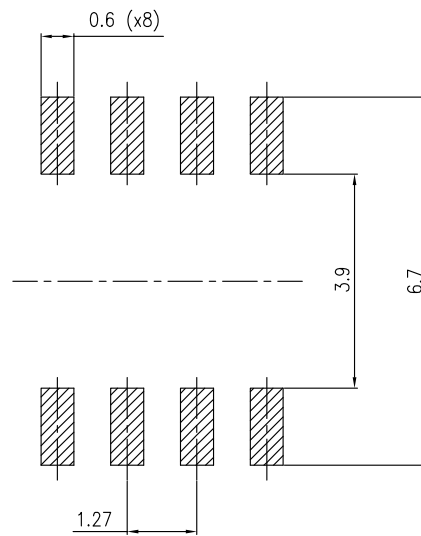

Table 6. SO8 package mechanical data

Ref.	Dimensions					
	Millimeters			Inches		
	Min.	Typ.	Max.	Min.	Typ.	Max.
A			1.75			0.069
A1	0.10		0.25	0.04		0.010
A2	1.25			0.049		
b	0.28	0.40	0.48	0.011	0.016	0.019
c	0.17		0.23	0.007		0.010
D	4.80	4.90	5.00	0.189	0.193	0.197
E	5.80	6.00	6.20	0.228	0.236	0.244
E1	3.80	3.90	4.00	0.150	0.154	0.157
e		1.27			0.050	
h	0.25		0.50	0.010		0.020
L	0.40	0.635	1.27	0.016		0.050
L1		1.04			0.040	
k	1°		8°	1°		8°
ccc			0.10			0.004

Figure 53. SO8 recommended footprint

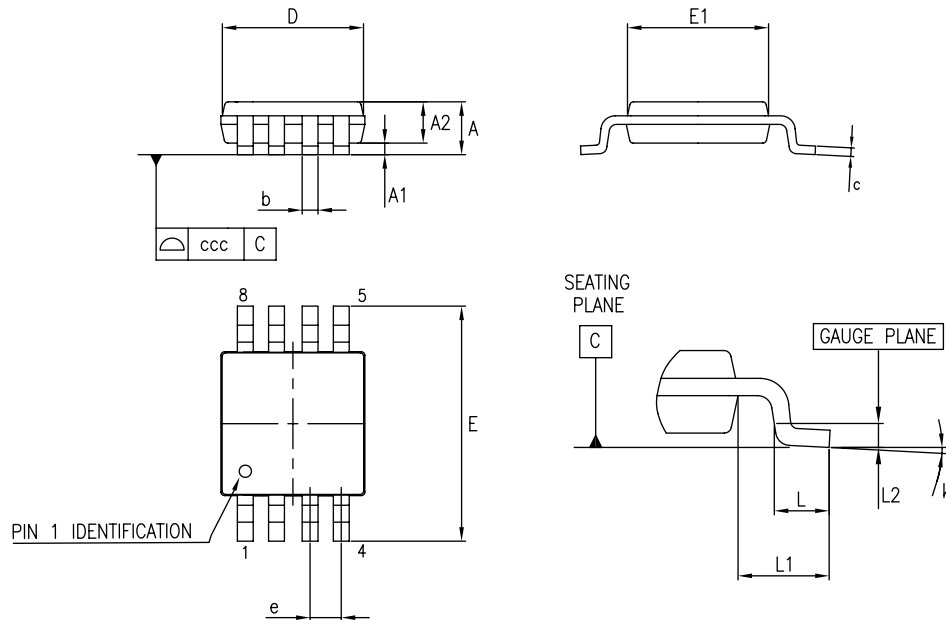

5.2 MiniSO8 package information

Figure 54. MiniSO8 package outline

Table 7. MiniSO8 mechanical data

Ref.	Dimensions					
	Millimeters			Inches		
	Min.	Typ.	Max.	Min.	Typ.	Max.
A			1.1			0.043
A1	0		0.15	0		0.006
A2	0.75	0.85	0.95	0.03	0.033	0.037
b	0.22		0.4	0.009		0.016
c	0.08		0.23	0.003		0.009
D	2.8	3	3.2	0.11	0.118	0.126
E	4.65	4.9	5.15	0.183	0.193	0.203
E1	2.8	3	3.1	0.11	0.118	0.122
e		0.65			0.026	
L	0.4	0.6	0.8	0.016	0.024	0.031
L1		0.95			0.037	
L2		0.25			0.01	
k	0°		8°	0°		8°
ccc			0.1			0.004

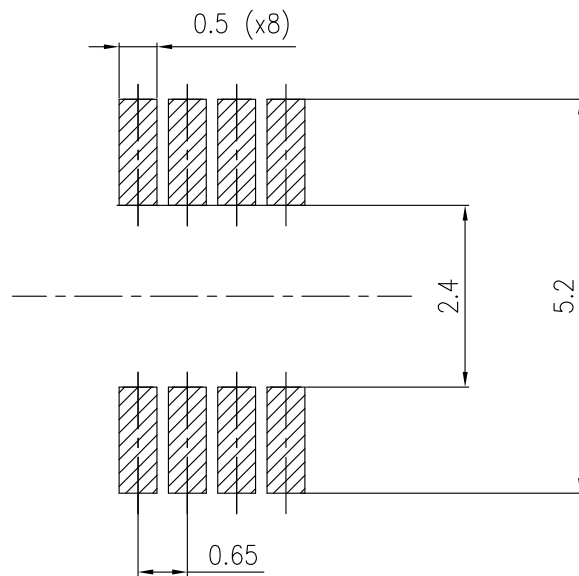
Figure 55. MiniSO8 recommended footprint



6 Ordering information

Table 8. Order codes

Order code	Gain (V/V)	Package	Packaging	Marking
TSC2020IDT	20	SO8	Tape & Reel	TSC2020
TSC2020IYDT ⁽¹⁾				TSC2020Y
TSC2020IST		MiniSO8		O129
TSC2020IYST ⁽¹⁾				O132
TSC2021IDT	50	SO8		TSC2021
TSC2021IYDT ⁽¹⁾				TSC2021Y
TSC2021IST		MiniSO8		O130
TSC2021IYST ⁽¹⁾				O133
TSC2022IDT	100	SO8		TSC2022
TSC2022IYDT ⁽¹⁾				TSC2022Y
TSC2022IST		MiniSO8		O131
TSC2022IYST ⁽¹⁾				O134

1. Qualified and characterized according to AEC Q100 and Q003 or equivalent, advanced screening according to AEC Q001 & Q002 or equivalent.

Revision history

Table 9. Document revision history

Date	Revision	Changes
22-Sep-2023	1	Initial release.
20-May-2024	2	Added new TSC2021 and TSC2022 order codes in Table 8.
02-Jul-2024	3	Updated RT condition, Acc parameter in Table 4 and Section 4: Typical characteristics.

Contents

1	Block diagram and pin description	2
2	Absolute maximum ratings and operation conditions	3
3	Electrical characteristics	4
4	Typical characteristics	8
5	Package information	18
5.1	SO8 package information	19
5.2	MiniSO8 package information	21
6	Ordering information	23
	Revision history	24

List of tables

Table 1.	Pin description	2
Table 2.	Absolute maximum ratings	3
Table 3.	Operating conditions	3
Table 4.	Electrical characteristics - $V_{CC} = 2.7\text{ V}$, $V_{ICM} = 48\text{ V}$, $T = 25\text{ }^{\circ}\text{C}$ (unless otherwise specified).	4
Table 5.	Electrical characteristics - $V_{CC} = 5\text{ V}$, $V_{ICM} = 48\text{ V}$, $T = 25\text{ }^{\circ}\text{C}$ (unless otherwise specified).	6
Table 6.	SO8 package mechanical data	19
Table 7.	MiniSO8 mechanical data	21
Table 8.	Order codes	23
Table 9.	Document revision history	24

List of figures

Figure 1.	Block diagram	2
Figure 2.	Pin connections (top view)	2
Figure 3.	Input offset production distribution	8
Figure 4.	Gain error production distribution	8
Figure 5.	Common-mode rejection ratio production distribution	8
Figure 6.	Supply current vs. supply voltage	8
Figure 7.	Supply current vs. input common-mode	9
Figure 8.	Supply current vs. temperature	9
Figure 9.	Input bias current vs. input common-mode	9
Figure 10.	Input bias current vs. temperature	9
Figure 11.	Input bias current vs. input common-mode	9
Figure 12.	Input bias current vs. Vsense	9
Figure 13.	Input offset voltage vs. temperature	10
Figure 14.	Input offset voltage vs. input common-mode with $V_{CC} = 5.5\text{ V}$	10
Figure 15.	Input offset voltage vs. input common-mode with $V_{CC} = 2.7\text{ V}$	10
Figure 16.	Input offset voltage vs. supply voltage	10
Figure 17.	Output current vs. output voltage	11
Figure 18.	Output current vs. temperature with $V_{CC} = 5.5\text{ V}$	11
Figure 19.	Output current vs. temperature with $V_{CC} = 2.7\text{ V}$	11
Figure 20.	V_{oh} and V_{ol} vs. temperature with $V_{CC} = 5.5\text{ V}$	11
Figure 21.	V_{oh} and V_{ol} vs. temperature with $V_{CC} = 2.7\text{ V}$	11
Figure 22.	Linearity vs. Vsense with $V_{CC} = 5.5\text{ V}$	11
Figure 23.	Linearity vs. Vsense	12
Figure 24.	Gain error vs. input common-mode different V_{CC}	12
Figure 25.	Gain error vs. input common-mode voltage different temperature	12
Figure 26.	Load regulation with $V_{CC} = 5\text{ V}$	12
Figure 27.	Gain vs. frequency	13
Figure 28.	Gain vs. frequency with different capacitive load	13
Figure 29.	Gain vs. frequency with different capacitive load (TSC2021)	13
Figure 30.	Gain vs. frequency with different capacitive load (TSC2022)	13
Figure 31.	Bandwidth vs. input common-mode	14
Figure 32.	Overshoot vs. capacitive load	14
Figure 33.	Small signal response with $V_{CC} = 5\text{ V}$	14
Figure 34.	Large signal response with $V_{CC} = 5\text{ V}$	14
Figure 35.	Large signal response with $V_{CC} = 5\text{ V}$ (TSC2021)	14
Figure 36.	Large signal response with $V_{CC} = 5\text{ V}$ (TSC2022)	14
Figure 37.	Positive settling time 1% vs. input common-mode	15
Figure 38.	Negative settling time 1% vs. input common-mode	15
Figure 39.	48 V common-mode positive step response recovery	15
Figure 40.	48 V common-mode negative step response recovery	15
Figure 41.	100 V common-mode positive step response recovery	16
Figure 42.	100 V common-mode negative step response recovery	16
Figure 43.	PSRR vs. frequency	16
Figure 44.	CMRR vs. frequency	16
Figure 45.	Positive overvoltage recovery	16
Figure 46.	Negative overvoltage recovery	16
Figure 47.	Overvoltage recovery vs input common-mode, $V_{CC} = 5\text{ V}$	17
Figure 48.	Noise vs. frequency	17
Figure 49.	0.1 Hz to 10 Hz voltage noise	17
Figure 50.	Power up time delay	17
Figure 51.	Output impedance vs. frequency	17



Figure 52.	SO8 package outline	19
Figure 53.	SO8 recommended footprint.	20
Figure 54.	MiniSO8 package outline	21
Figure 55.	MiniSO8 recommended footprint.	22

IMPORTANT NOTICE – READ CAREFULLY

STMicroelectronics NV and its subsidiaries (“ST”) reserve the right to make changes, corrections, enhancements, modifications, and improvements to ST products and/or to this document at any time without notice. Purchasers should obtain the latest relevant information on ST products before placing orders. ST products are sold pursuant to ST’s terms and conditions of sale in place at the time of order acknowledgment.

Purchasers are solely responsible for the choice, selection, and use of ST products and ST assumes no liability for application assistance or the design of purchasers’ products.

No license, express or implied, to any intellectual property right is granted by ST herein.

Resale of ST products with provisions different from the information set forth herein shall void any warranty granted by ST for such product.

ST and the ST logo are trademarks of ST. For additional information about ST trademarks, refer to www.st.com/trademarks. All other product or service names are the property of their respective owners.

Information in this document supersedes and replaces information previously supplied in any prior versions of this document.

© 2024 STMicroelectronics – All rights reserved