



## ANT-DB1-RAF

### Hinged Blade WiFi 6/5/4 Antenna

The ANT-DB1-RAF is a dipole, blade-style antenna for WiFi 6/5/4 applications in the 2.4 GHz and 5 GHz bands and WiFi 6E in the 6 GHz band.

The hinged design allows for the antenna to be positioned for optimum performance and reduces the potential for damage from impact compared to a fixed whip design. The ANT-DB1-RAF antenna is available with an SMA plug (male pin), or RP-SMA plug (female socket) connector.

#### FEATURES

- Performance at 2.4 GHz to 2.485 GHz
  - VSWR:  $\leq 1.8$
  - Peak Gain: 4.1 dBi
  - Efficiency: 76%
- Performance at 5.150 GHz to 5.850 GHz
  - VSWR:  $\leq 1.7$
  - Peak Gain: 5.1 dBi
  - Efficiency: 94%
- Compact size
  - Height: 103.7 mm (4.08 in)
  - Diameter: 11.2 mm (0.44 in)
- Rotating hinge design with detents for straight, 45 degree and 90 degree positioning
- SMA plug (male pin) or RP-SMA plug (female socket) connection

#### APPLICATIONS

- WiFi/WLAN coverage
  - WiFi 6E (802.11ax)
  - WiFi 6 (802.11ax)
  - WiFi 5 (802.11ac)
  - WiFi 4 (802.11n)
  - 802.11b/g
- 2.4 GHz ISM applications
  - Bluetooth®
  - ZigBee®
- U-NII bands 1-8
- Internet of Things (IoT) devices
- Smart Home networking
  - Sensing and remote monitoring
  - Wireless vending
  - Security

#### ORDERING INFORMATION

Part Number	Description
ANT-DB1-RAF-SMA	WiFi 6/WiFi 6E blade-style antenna with SMA plug (male pin)
ANT-DB1-RAF-RPS	WiFi 6/WiFi 6E blade-style antenna with RP-SMA plug (female socket)

Available from Linx Technologies and select distributors and representatives.

## TABLE 1. ELECTRICAL SPECIFICATIONS

ANT-DB1-RAF	ISM/WiFi	WiFi/U-NII 1-3	WiFi 6E
Frequency Range	2400 MHz to 2485 MHz	5150 MHz to 5850 MHz	5925 MHz to 7125 MHz
VSWR (max.)	1.8	1.7	6.1
Peak Gain (dBi)	4.1	5.1	4.8
Average Gain (dBi)	-1.4	-0.6	-2.0
Efficiency (%)	76	94	72
Polarization	Linear	Impedance	50 $\Omega$
Radiation	Omnidirectional	Electrical Type	Dipole
Wavelength	1/2-wave	Max Power	5 W

Electrical specifications and plots measured in free space with antenna straight.

## TABLE 2. MECHANICAL SPECIFICATIONS

Parameter	
Connection	RP-SMA plug (female socket) or SMA plug (male pin)
Dimensions	103.7 mm x $\varnothing$ 11.2 mm (4.08 in x $\varnothing$ 0.44 in)
Weight	12.7 g (0.45 oz)
Operating Temp. Range	-40 °C to +80 °C

## PRODUCT DIMENSIONS

Figure 1 provides dimensions of the ANT-DB1-RAF antenna. The antenna whip can be tilted 90 degrees, and has a detent at 45 degrees enabling the antenna to be oriented in any direction. The rotating base allows for continuous positioning through 360 degrees even while installed.

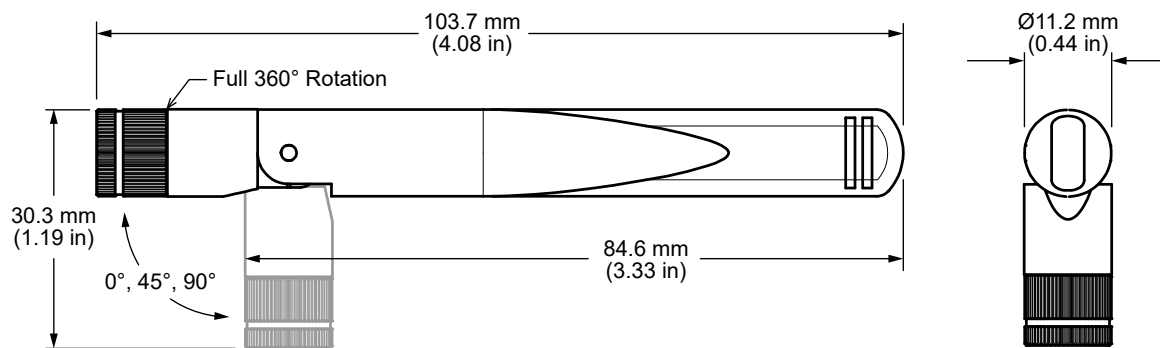

Figure 1. ANT-DB1-RAF Antenna Dimensions

## PACKAGING INFORMATION

The ANT-DB1-RAF antenna is packaged in a plastic bag in quantities of 50. Bags are placed in cartons of 200. Distribution channels may offer alternative packaging options.

---

## ANTENNA ORIENTATION

The ANT-DB1-RAF antenna is characterized in two antenna orientations as shown in Figure 2. The free space antenna straight orientation characterizes use of an antenna attached to an enclosure-mounted connector. Although the antenna is a dipole not requiring a ground plane for function, the second characterization with an adjacent ground plane (102 mm x 102 mm) provides insight into antenna performance when attached directly to a printed circuit board mounted connector. The two orientations represent the most common end-product use cases.

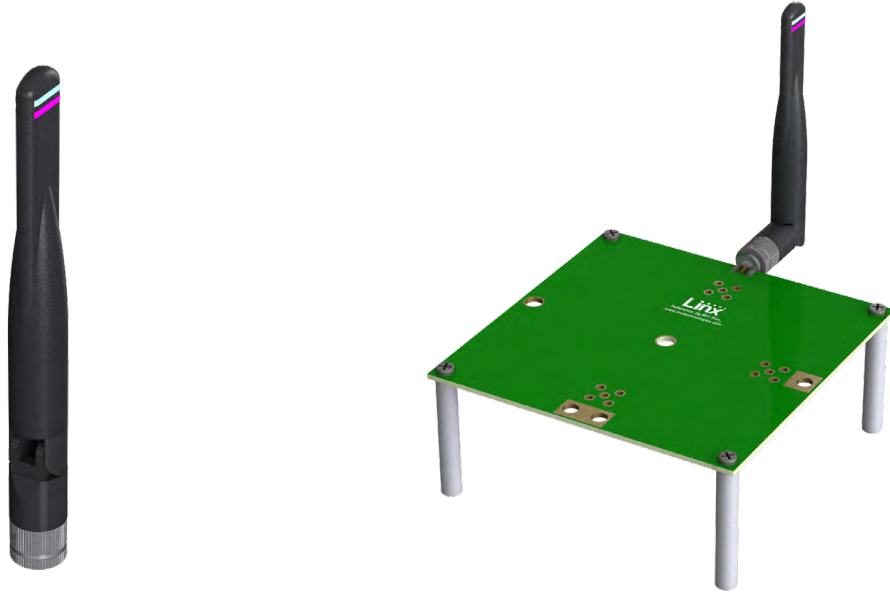

**Straight, Free Space without ground plane**

**On edge of ground plane, bent 90 degrees**

Figure 2. ANT-DB1-RAF Antenna Evaluation Orientations

## STRAIGHT, FREE SPACE

The charts on the following pages represent data taken with the antenna in free space, with straight orientation, as shown in Figure 3



Figure 3. ANT-DB1-RAF Antenna Straight, Free Space (Straight)

## VSWR

Figure 4 provides the voltage standing wave ratio (VSWR) across the antenna bandwidth. VSWR describes the power reflected from the antenna back to the radio. A lower VSWR value indicates better antenna performance at a given frequency. Reflected power is also shown on the right-side vertical axis as a gauge of the percentage of transmitter power reflected back from the antenna.

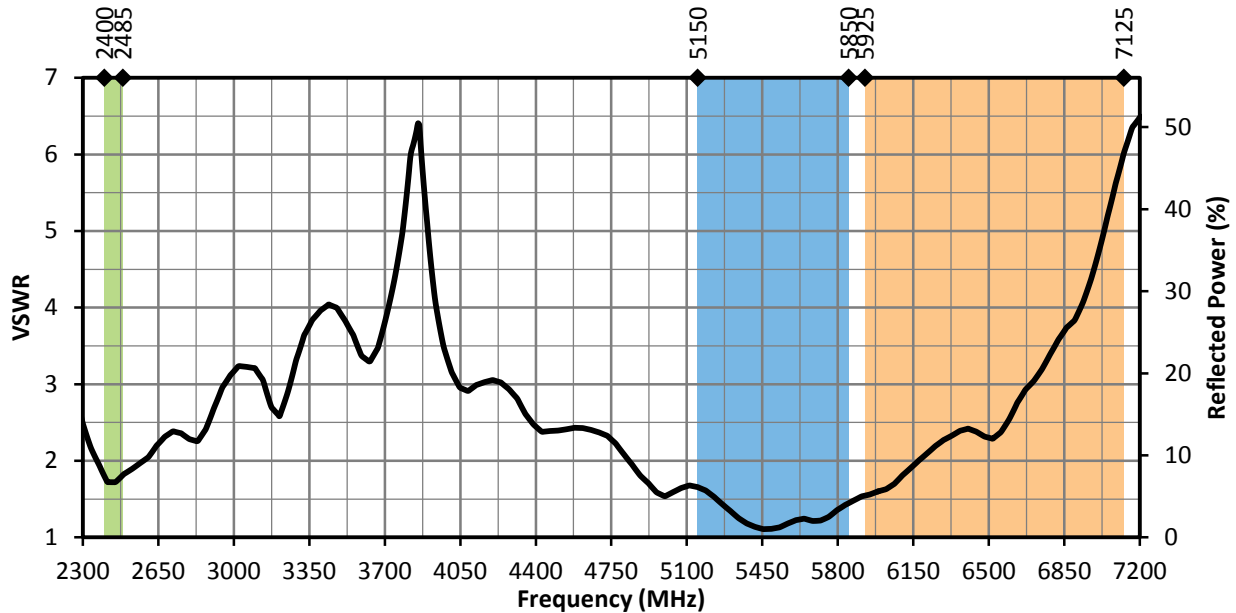

Figure 4. ANT-DB1-RAF Antenna VSWR, Straight

## RETURN LOSS

Return loss (Figure 5), represents the loss in power at the antenna due to reflected signals. Like VSWR, a lower return loss value indicates better antenna performance at a given frequency.

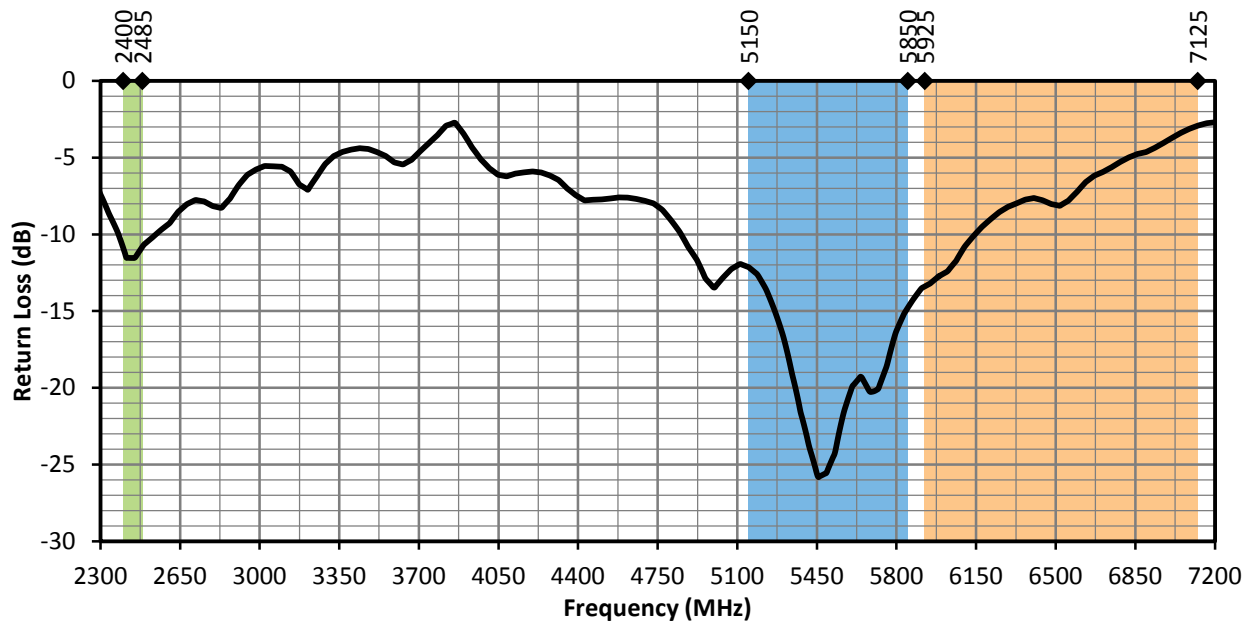

Figure 5. Return Loss for ANT-DB1-RAF, Straight

## PEAK GAIN

The peak gain across the antenna bandwidth is shown in Figure 6. Peak gain represents the maximum antenna input power concentration across 3-dimensional space, and therefore peak performance, at a given frequency, but does not consider any directionality in the gain pattern.

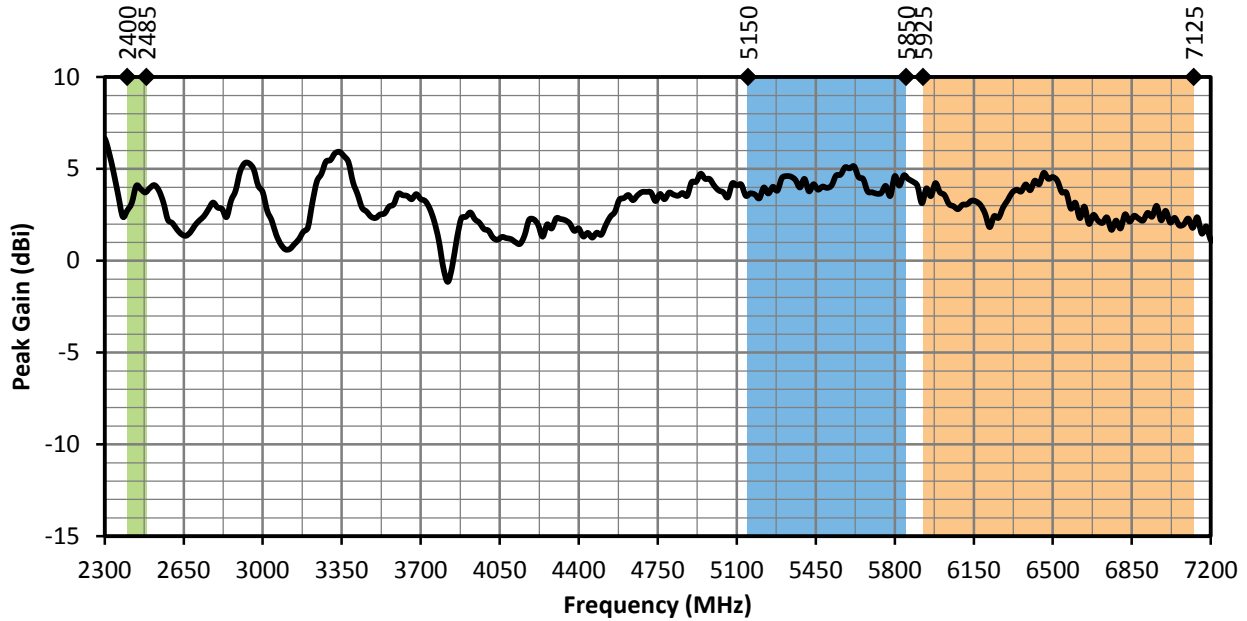

Figure 6. Peak Gain for ANT-DB1-RAF, Straight

## AVERAGE GAIN

Average gain (Figure 7), is the average of all antenna gain in 3-dimensional space at each frequency, providing an indication of overall performance without expressing antenna directionality.

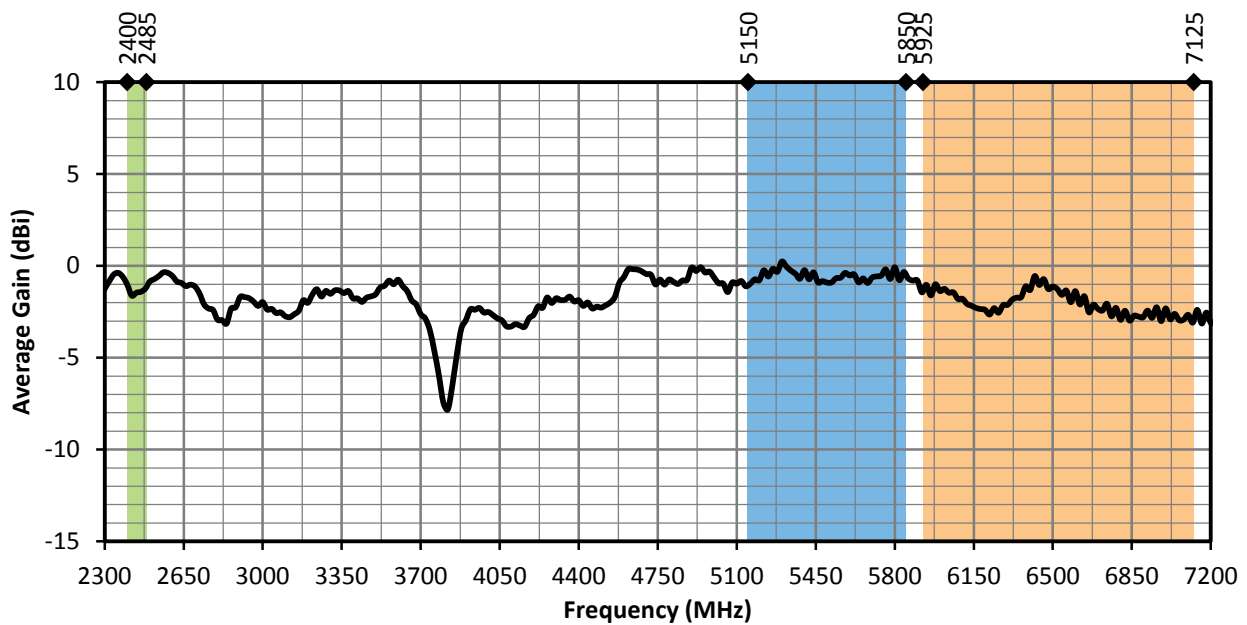

Figure 7. Antenna Average Gain for ANT-DB1-RAF, Straight

## RADIATION EFFICIENCY

Radiation efficiency (Figure 8), shows the ratio of power delivered to the antenna relative to the power radiated at the antenna, expressed as a percentage, where a higher percentage indicates better performance at a given frequency.

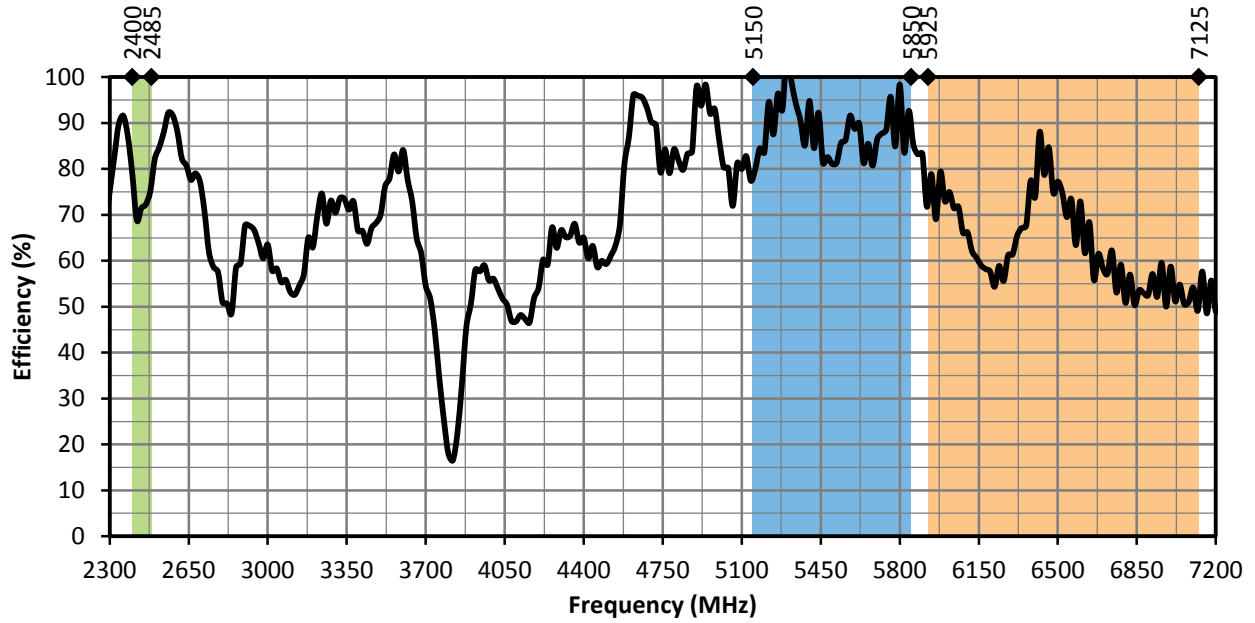

Figure 8. Antenna Radiation Efficiency for ANT-DB1-RAF, Straight

## RADIATION PATTERNS

Radiation patterns provide information about the directionality and 3-dimensional gain performance of the antenna by plotting gain at specific frequencies in three orthogonal planes. Antenna radiation patterns for a straight orientation are shown in Figure 9 using polar plots covering 360 degrees. The antenna graphic above the plots provides reference to the plane of the column of plots below it. Note: when viewed with typical PDF viewing software, zooming into radiation patterns is possible to reveal fine detail.

### RADIATION PATTERNS - STRAIGHT



XZ-Plane Gain



YZ-Plane Gain



XY-Plane Gain

### 2400 MHZ TO 2485 MHZ (2450 MHZ)

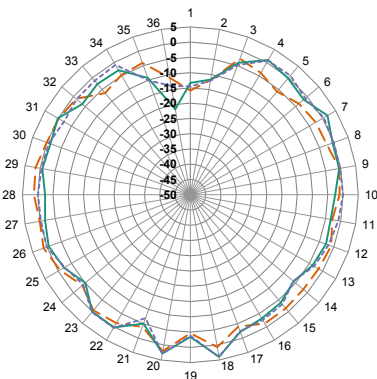

XZ-Plane Gain

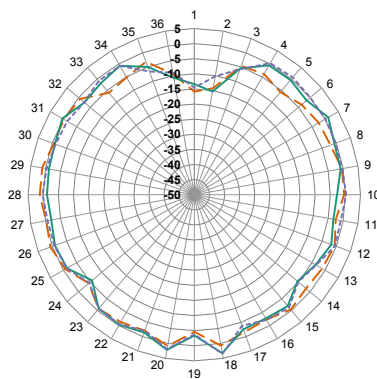

YZ-Plane Gain

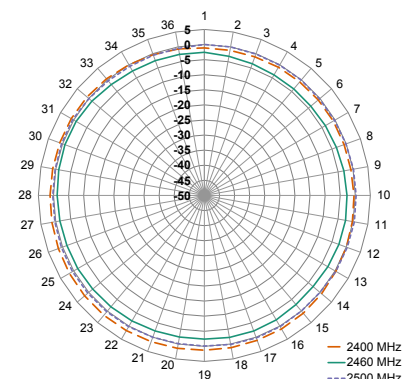

XY-Plane Gain

### 5150 MHZ TO 5850 MHZ (5500 MHZ)

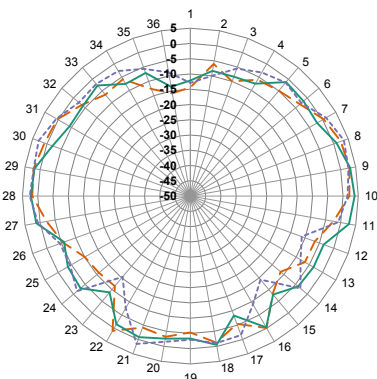

XZ-Plane Gain

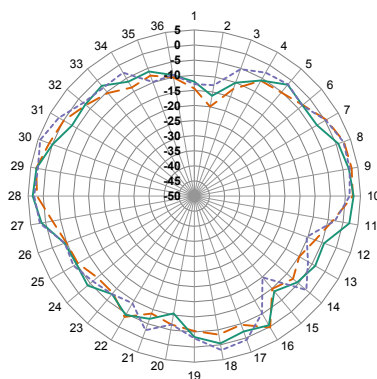

YZ-Plane Gain

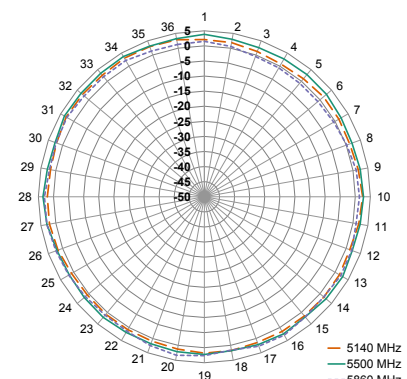

XY-Plane Gain

## RADIATION PATTERNS - STRAIGHT

### 5925 MHZ TO 7125 MHZ (6530 MHZ)

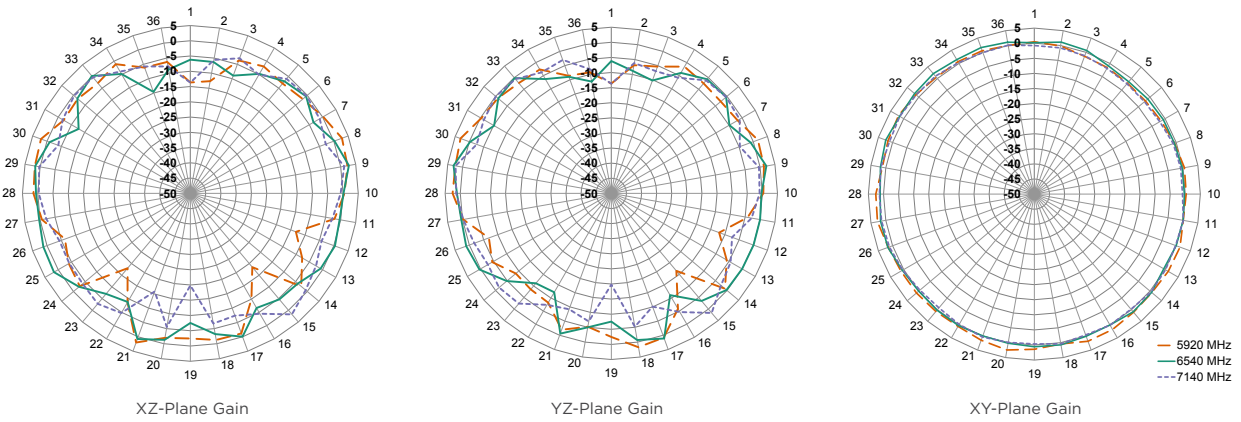

Figure 9. Radiation Patterns for ANT-DB1-RAF Antenna, Straight

### EDGE OF GROUND PLANE, BENT 90 DEGREES

The charts on the following pages represent data taken with the antenna oriented at the edge of the ground plane, bent 90 degrees (Edge-Bent), as shown in Figure 10.

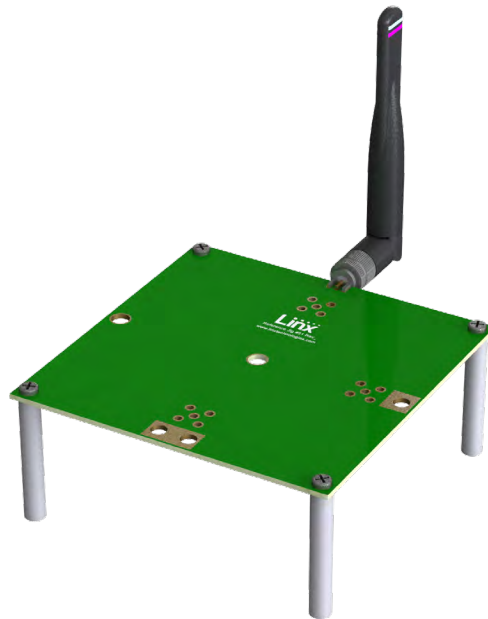

Figure 10. ANT-DB1-RAF Antenna on Edge of Ground Plane, Bent 90 Degrees (Edge-Bent)



## VSWR

Figure 11 provides the voltage standing wave ratio (VSWR) across the antenna bandwidth. VSWR describes the power reflected from the antenna back to the radio. A lower VSWR value indicates better antenna performance at a given frequency. Reflected power is also shown on the right-side vertical axis as a gauge of the percentage of transmitter power reflected back from the antenna.

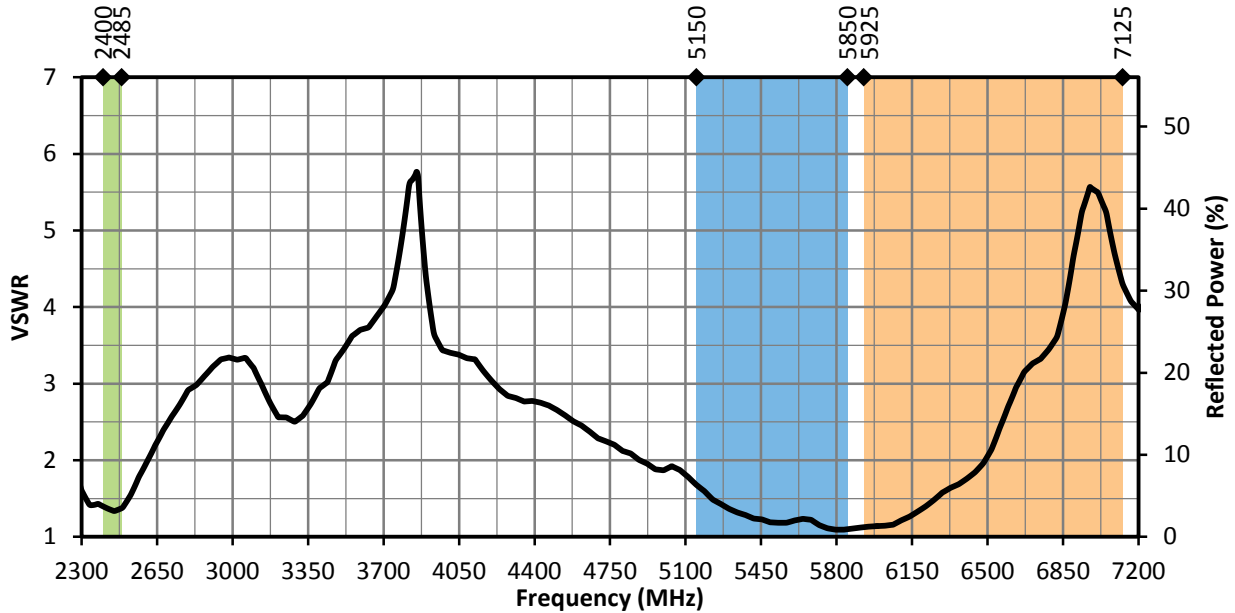

Figure 11. ANT-DB1-RAF Antenna VSWR, Edge-Bent

## RETURN LOSS

Return loss (Figure 12), represents the loss in power at the antenna due to reflected signals. Like VSWR, a lower return loss value indicates better antenna performance at a given frequency.

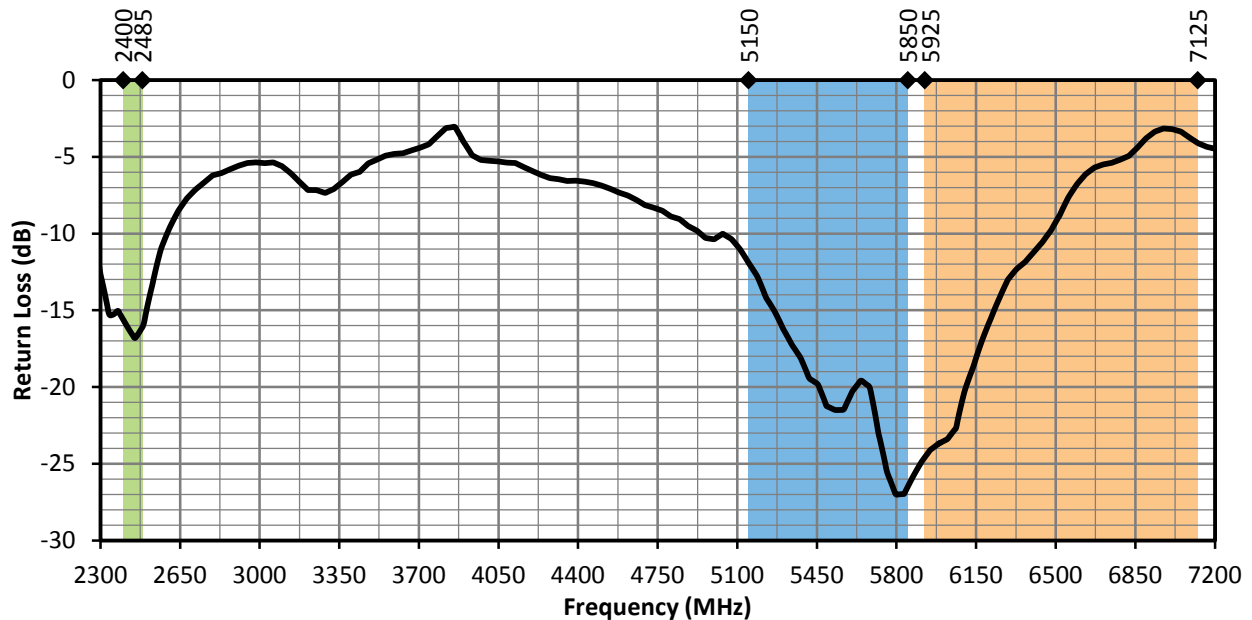

Figure 12. Return Loss for ANT-DB1-RAF, Edge-Bent

## PEAK GAIN

The peak gain across the antenna bandwidth is shown in Figure 13. Peak gain represents the maximum antenna input power concentration across 3-dimensional space, and therefore peak performance, at a given frequency, but does not consider any directionality in the gain pattern.

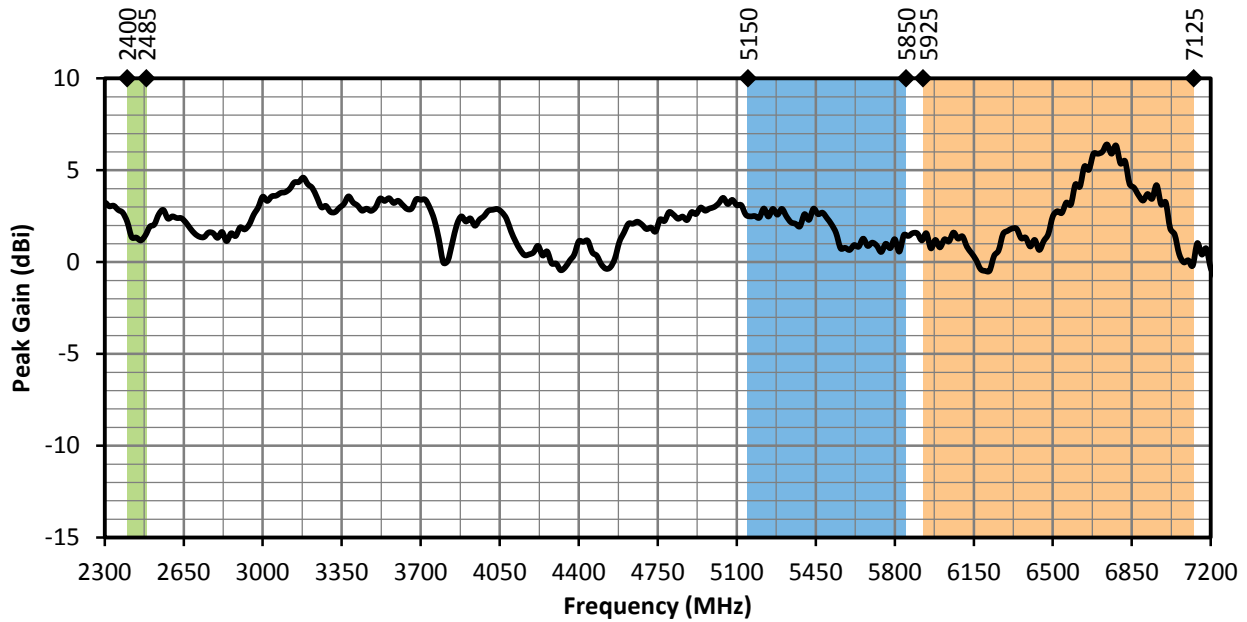

Figure 13. Peak Gain for ANT-DB1-RAF, Edge-Bent

## AVERAGE GAIN

Average gain (Figure 14), is the average of all antenna gain in 3-dimensional space at each frequency, providing an indication of overall performance without expressing antenna directionality.

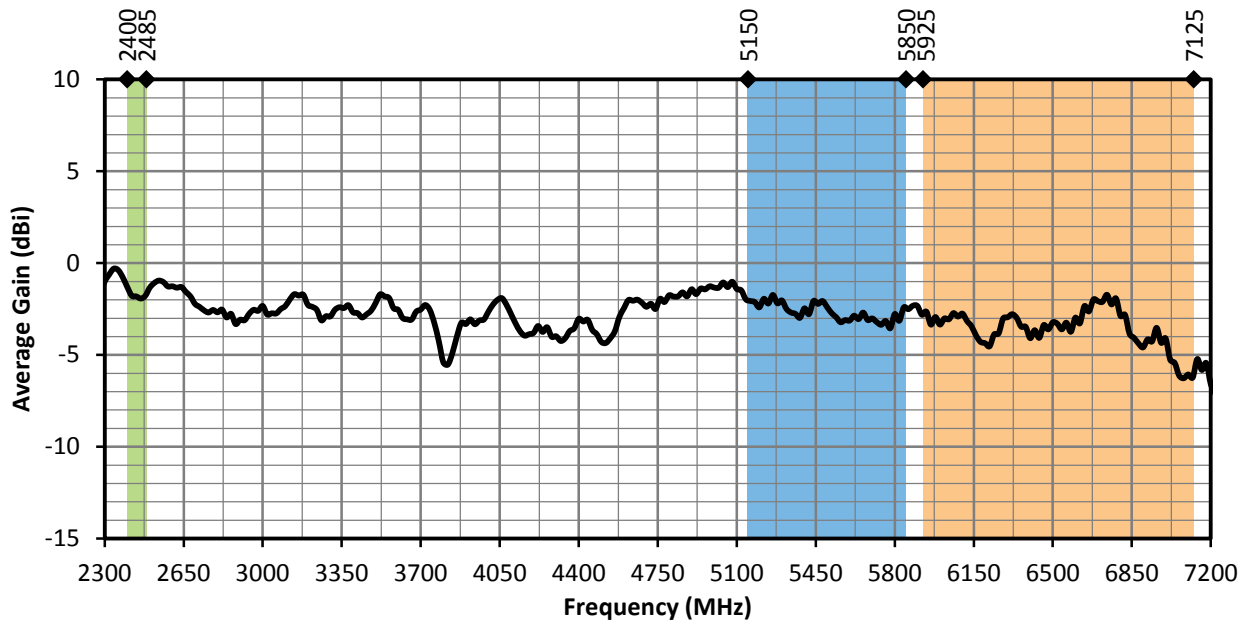

Figure 14. Antenna Average Gain for ANT-DB1-RAF, Edge-Bent

## RADIATION EFFICIENCY

Radiation efficiency (Figure 15), shows the ratio of power delivered to the antenna relative to the power radiated at the antenna, expressed as a percentage, where a higher percentage indicates better performance at a given frequency.

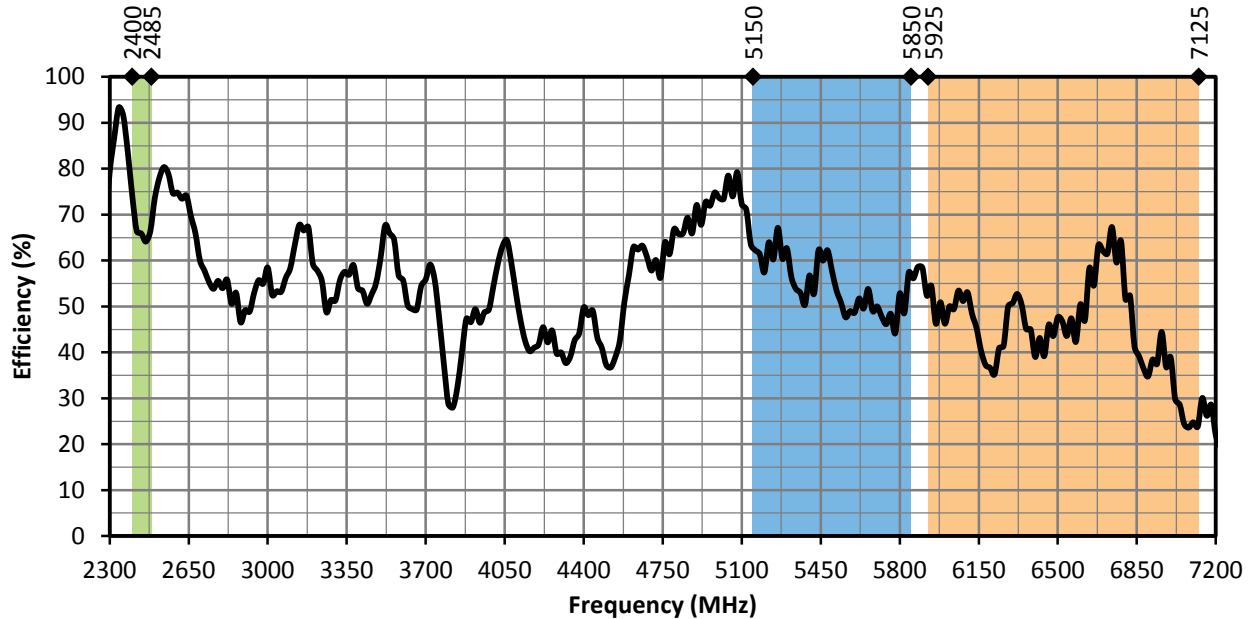
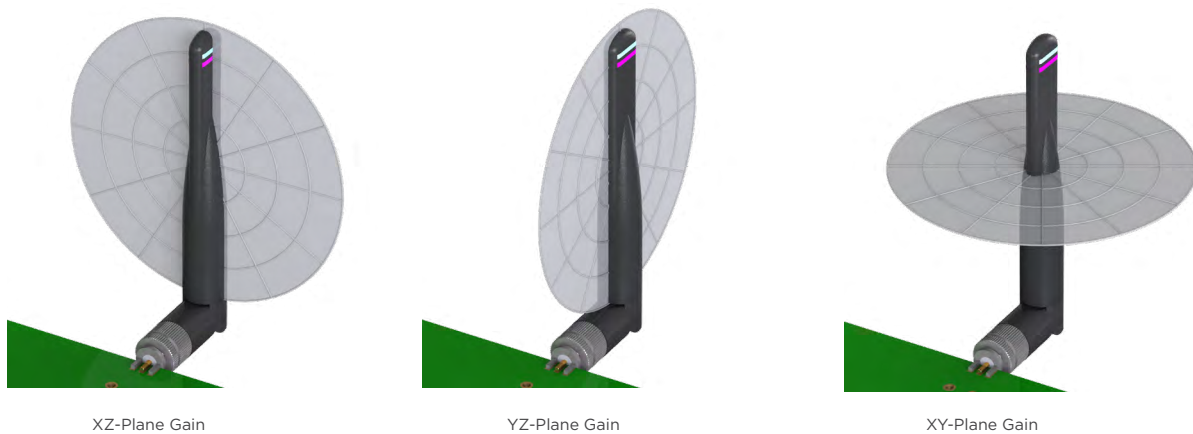

Figure 15. Antenna Radiation Efficiency for ANT-DB1-RAF, Edge-Bent

## RADIATION PATTERNS

Radiation patterns provide information about the directionality and 3-dimensional gain performance of the antenna by plotting gain at specific frequencies in three orthogonal planes. Antenna radiation patterns for an “edge-bent” orientation are shown in Figure 16 using polar plots covering 360 degrees. The antenna graphic above the plots provides reference to the plane of the column of plots below it. Note: when viewed with typical PDF viewing software, zooming into radiation patterns is possible to reveal fine detail.

## RADIATION PATTERNS - EDGE-BENT



## 2400 MHZ TO 2485 MHZ (2450 MHZ)

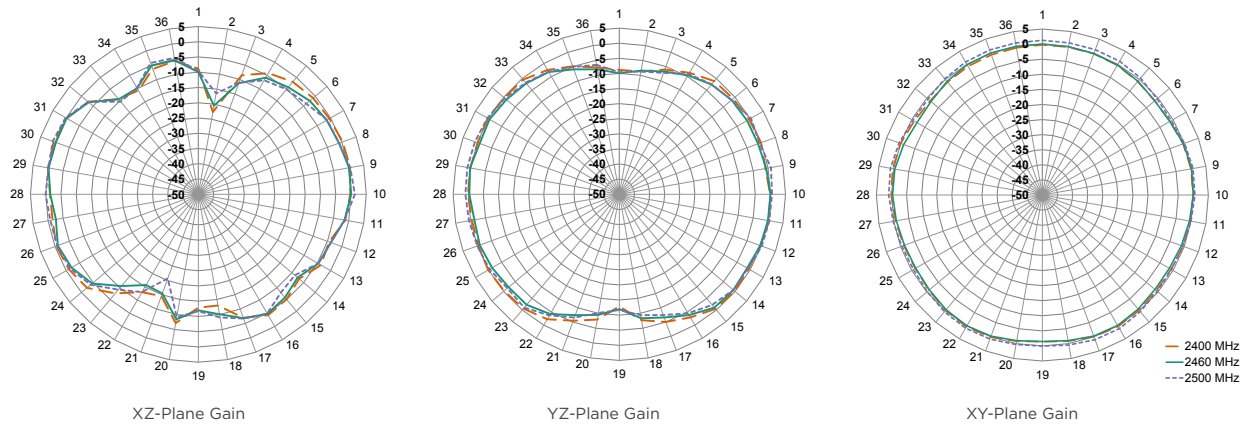

## 5150 MHZ TO 5850 MHZ (5500 MHZ)

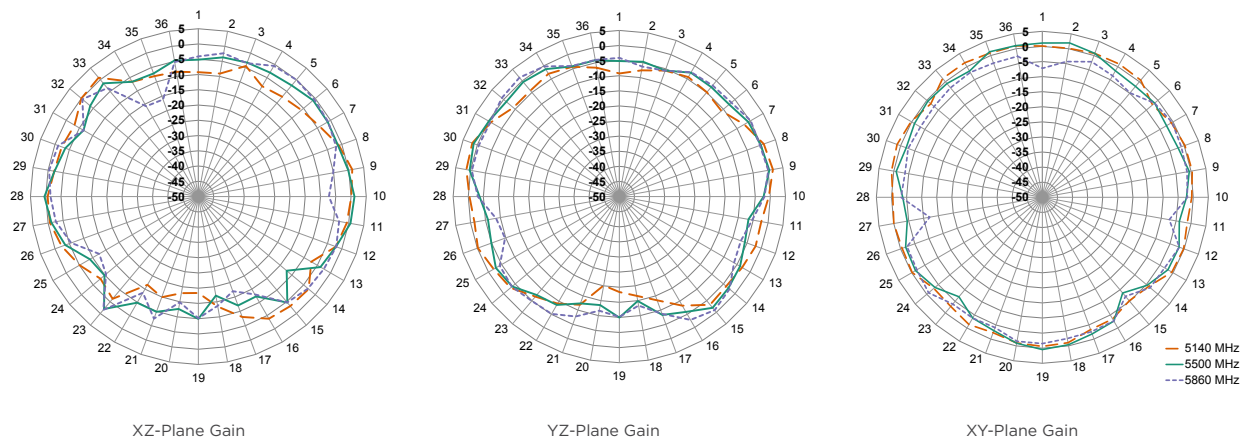

## RADIATION PATTERNS - EDGE-BENT

### 5925 MHZ TO 7125 MHZ (6530 MHZ)

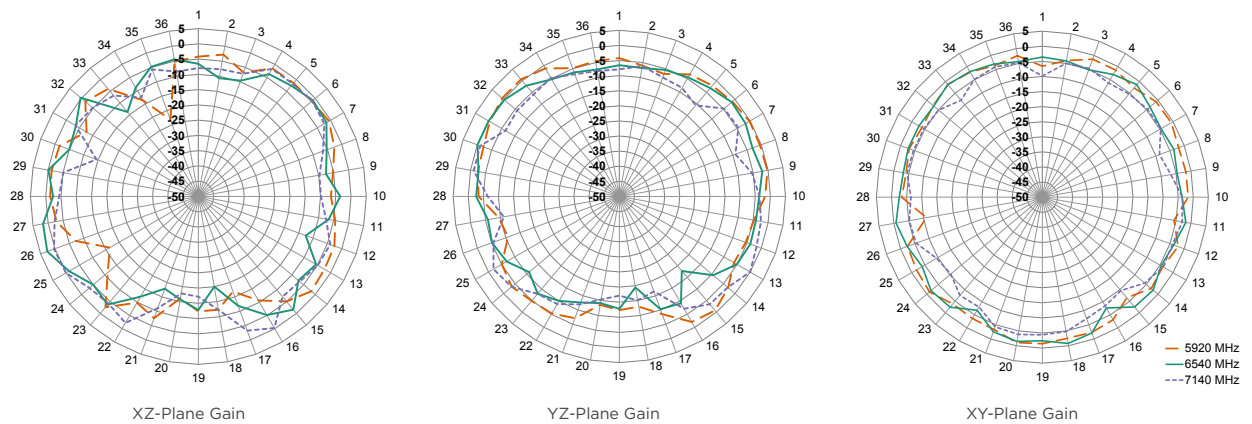

Figure 16. Radiation Patterns for ANT-DB1-RAF Antenna, Edge-Bent

---

## TE TECHNICAL SUPPORT CENTER

USA:	+1 (800) 522-6752
Canada:	+1 (905) 475-6222
Mexico:	+52 (0) 55-1106-0800
Latin/S. America:	+54 (0) 11-4733-2200
Germany:	+49 (0) 6251-133-1999
UK:	+44 (0) 800-267666
France:	+33 (0) 1-3420-8686
Netherlands:	+31 (0) 73-6246-999
China:	+86 (0) 400-820-6015

## te.com

TE Connectivity, TE, TE connectivity (logo), Linx and Linx Technologies are trademarks owned or licensed by the TE Connectivity Ltd. family of companies. All other logos, products and/or company names referred to herein might be trademarks of their respective owners.

The information given herein, including drawings, illustrations and schematics which are intended for illustration purposes only, is believed to be reliable. However, TE Connectivity makes no warranties as to its accuracy or completeness and disclaims any liability in connection with its use. TE Connectivity's obligations shall only be as set forth in TE Connectivity's Standard Terms and Conditions of Sale for this product and in no case will TE Connectivity be liable for any incidental, indirect or consequential damages arising out of the sale, resale, use or misuse of the product. Users of TE Connectivity products should make their own evaluation to determine the suitability of each such product for the specific application.

TE Connectivity warrants to the original end user customer of its products that its products are free from defects in material and workmanship. Subject to conditions and limitations TE Connectivity will, at its option, either repair or replace any part of its products that prove defective because of improper workmanship or materials. This limited warranty is in force for the useful lifetime of the original end product into which the TE Connectivity product is installed. Useful lifetime of the original end product may vary but is not warranted to exceed one (1) year from the original date of the end product purchase.

©2022 TE Connectivity. All Rights Reserved.

10/22 Original