

Description

The TSV639x series of dual and quad operational amplifiers (op amps) offers low voltage operation and rail-to-rail input and output.

For applications configured with gain, the TSV639x series offers an excellent speed/power consumption ratio, 2.4 MHz gain bandwidth product while consuming only 60 μ A at 5 V. The devices also feature an ultra-low input bias current and have a shutdown mode (TSV6393, TSV6395).

These features make the TSV639x family ideal for sensor interfaces, battery supplied and portable applications, as well as active filtering.

Features

- Rail-to-rail input and output
- Low-power consumption: 60 μ A typ at 5 V
- Low supply voltage: 1.5 V - 5.5 V
- Gain bandwidth product: 2.4 MHz typ, stable for gain equal or above -3 or 4
- Low-power shutdown mode: 5 nA typ
- Low offset voltage: 800 μ V max (A version)
- Low input bias current: 1 pA typ
- EMI hardened operational amplifiers
- High tolerance to ESD: 4 kV HBM
- Extended temperature range: -40 $^{\circ}$ C to 125 $^{\circ}$ C

Applications

- Battery-powered applications
- Portable devices
- Signal conditioning
- Active filtering
- Medical instrumentation

Package pin connections

Figure 1: Pin connections for each package (top view)



Absolute maximum ratings and operating conditions

Table 2: Absolute maximum ratings (AMR)

Symbol	Parameter	Value	Unit	
V_{CC}	Supply voltage ⁽¹⁾	6	V	
V_{id}	Differential input voltage ⁽²⁾	$\pm V_{CC}$		
V_{in}	Input voltage ⁽³⁾	$(V_{CC}^-) - 0.2$ to $(V_{CC}^+) + 0.2$		
I_{in}	Input current ⁽⁴⁾	10	mA	
\overline{SHDN}	Shutdown voltage ⁽³⁾	$(V_{CC}^-) - 0.2$ to $(V_{CC}^+) + 0.2$	V	
T_{stg}	Storage temperature	-65 to 150	°C	
T_j	Maximum junction temperature	150		
R_{thja}	Thermal resistance junction to ambient ^{(5)/(6)}	SOP-8	125	°C/W
		TSSOP14	100	
ESD	HBM: human body model ⁽⁷⁾	4	kV	
	MM: machine model ⁽⁸⁾	300	V	
	CDM: charged device model ⁽⁹⁾	1.5	kV	
	Latch-up immunity	200	mA	

Notes:

- ⁽¹⁾All voltage values, except the differential voltage are with respect to the network ground terminal.
- ⁽²⁾Differential voltages are the non-inverting input terminal with respect to the inverting input terminal.
- ⁽³⁾ $V_{CC} - V_{in}$ must not exceed 6 V, V_{in} must not exceed 6 V.
- ⁽⁴⁾The input current must be limited by a resistor in-series with the inputs.
- ⁽⁵⁾ R_{th} are typical values.
- ⁽⁶⁾Short-circuits can cause excessive heating and destructive dissipation.
- ⁽⁷⁾Human body model: 100 pF discharged through a 1.5 k Ω resistor between two pins of the device, done for all couples of pin combinations with other pins floating.
- ⁽⁸⁾Machine model: a 200 pF capacitor is charged to the specified voltage, then discharged directly between two pins of the device with no external series resistor (internal resistor < 5 Ω), done for all couples of pin combinations with other pins floating.
- ⁽⁹⁾Charged device model: all pins plus package are charged together to the specified voltage and then discharged directly to the ground.

Table 3: Operating conditions

Symbol	Parameter	Value	Unit
V_{CC}	Supply voltage	1.5 to 5.5	V
V_{icm}	Common-mode input voltage range	$(V_{CC}^-) - 0.1$ to $(V_{CC}^+) + 0.1$	
T_{oper}	Operating free-air temperature range	-40 to 125	°C

Electrical characteristics

Table 4: Electrical characteristics at $V_{CC+} = 1.8$ V with $V_{CC-} = 0$ V, $V_{icm} = V_{CC}/2$, $T_{amb} = 25$ °C, and R_L connected to $V_{CC}/2$ (unless otherwise specified)

Symbol	Parameter	Conditions	Min.	Typ.	Max.	Unit
DC performance						
V_{io}	Offset voltage	TSV639x			3	mV
		TSV639xA			0.8	
		$T_{min} < T_{op} < T_{max}$, TSV639x			4.5	
		$T_{min} < T_{op} < T_{max}$, TSV639xA			2	
DV_{io}	Input offset voltage drift			2		μ V/°C
I_{io}	Input offset current, $V_{out} = V_{CC}/2$			1	10 ⁽¹⁾	pA
		$T_{min} < T_{op} < T_{max}$		1	100	
I_{ib}	Input bias current, $V_{out} = V_{CC}/2$			1	10 ⁽¹⁾	pA
		$T_{min} < T_{op} < T_{max}$		1	100	
CMR	Common mode rejection ratio $20 \log (\Delta V_{ic}/\Delta V_{io})$	0 V to 1.8 V, $V_{out} = 0.9$ V	53	74		dB
		$T_{min} < T_{op} < T_{max}$	51			
A_{vd}	Large signal voltage gain	$R_L = 10$ k Ω , $V_{out} = 0.5$ V to 1.3 V	85	95		dB
		$T_{min} < T_{op} < T_{max}$	80			
V_{OH}	High-level output voltage, $V_{OH} = V_{CC} - V_{out}$	$R_L = 10$ k Ω		5	35	mV
		$R_L = 10$ k Ω , $T_{min} < T_{op} < T_{max}$			50	
V_{OL}	Low-level output voltage	$R_L = 10$ k Ω		4	35	mV
		$R_L = 10$ k Ω , $T_{min} < T_{op} < T_{max}$			50	
I_{out}	I_{sink}	$V_o = 1.8$ V	6	12		mA
		$T_{min} < T_{op} < T_{max}$	4			
	I_{source}	$V_o = 0$ V	6	10		
		$T_{min} < T_{op} < T_{max}$	4			
I_{CC}	Supply current (per operator)	No load, $V_{out} = V_{CC}/2$	40	50	60	μ A
		$T_{min} < T_{op} < T_{max}$			62	
AC performance						
GBP	Gain bandwidth product	$R_L = 10$ k Ω , $C_L = 100$ pF		2		MHz
Gain	Minimum gain for stability	Phase margin = 60 °, $R_f = 10$ k Ω , $R_L = 10$ k Ω , $C_L = 20$ pF		4		V/V
					-3	
SR	Slew rate	$R_L = 10$ k Ω , $C_L = 100$ pF, $V_{out} = 0.5$ V to 1.3 V		0.7		V/ μ s
e_n	Equivalent input noise voltage	$f = 1$ kHz		60		nV/ \sqrt Hz
		$f = 10$ kHz		33		

Micropower (60 μ A), wide bandwidth (2.4 MHz) CMOS op amps

Table 5: Shutdown characteristics VCC = 1.8 V

Symbol	Parameter	Conditions	Min.	Typ.	Max.	Unit
DC performance						
I_{CC}	Supply current in shutdown mode (all operators)	$\overline{SHDN} = V_{CC}^-$		2.5	50	nA
		$T_{min} < T_{op} < 85\text{ }^\circ\text{C}$			200	
		$T_{min} < T_{op} < 125\text{ }^\circ\text{C}$			1.5	μ A
t_{on}	Amplifier turn-on time	$R_L = 2\text{ k}\Omega$, $V_{out} = (V_{CC}^-)$ to $(V_{CC}^-) + 0.2\text{ V}$		200		ns
t_{off}	Amplifier turn-off time	$R_L = 2\text{ k}\Omega$, $V_{out} = (V_{CC}^+) - 0.5\text{ V}$ to $(V_{CC}^+) - 0.7\text{ V}$		20		
V_{IH}	\overline{SHDN} logic high		1.35			V
V_{IL}	\overline{SHDN} logic low				0.6	
I_{IH}	\overline{SHDN} current high	$\overline{SHDN} = V_{CC}^+$		10		pA
I_{IL}	\overline{SHDN} current low	$\overline{SHDN} = V_{CC}^-$		10		
I_{OLeak}	Output leakage in shutdown mode	$\overline{SHDN} = V_{CC}^-$		50		
		$T_{min} < T_{op} < 125\text{ }^\circ\text{C}$		1		nA

Micropower (60 μ A), wide bandwidth (2.4 MHz) CMOS op amps

Table 6: Electrical characteristics at VCC+ = 3.3 V, VCC- = 0 V, Vicm = VCC/2, Tamb = 25 °C, RL connected to VCC/2 (unless otherwise specified)

Symbol	Parameter	Conditions	Min.	Typ.	Max.	Unit
DC performance						
V _{io}	Offset voltage	TSV639x			3	mV
		TSV639xA			0.8	
		T _{min} < T _{op} < T _{max} , TSV639x			4.5	
		T _{min} < T _{op} < T _{max} , TSV639xA			2	
DV _{io}	Input offset voltage drift			2		μ V/°C
I _{io}	Input offset current			1	10 ⁽¹⁾	pA
		T _{min} < T _{op} < T _{max}		1	100	
I _{ib}	Input bias current			1	10 ⁽¹⁾	pA
		T _{min} < T _{op} < T _{max}		1	100	
CMR	Common mode rejection ratio 20 log ($\Delta V_{ic}/\Delta V_{io}$)	0 V to 3.3 V, V _{out} = 1.65 V	57	79		dB
		T _{min} < T _{op} < T _{max}	53			
A _{vd}	Large signal voltage gain	R _L = 10 k Ω , V _{out} = 0.5 V to 2.8 V	88	98		dB
		T _{min} < T _{op} < T _{max}	83			
V _{OH}	High-level output voltage, V _{OH} = V _{CC} - V _{out}	R _L = 10 k Ω		6	35	mV
		R _L = 10 k Ω , T _{mi.} < T _{op} < T _{max}			50	
V _{OL}	Low-level output voltage	R _L = 10 k Ω		7	35	mV
		R _L = 10 k Ω , T _{min} < T _{op} < T _{max}			50	
I _{out}	I _{sink}	V _o = 3.3 V	23	45		mA
		T _{min} < T _{op} < T _{max}	20			
	I _{source}	V _o = 0 V	23	38		
		T _{min} < T _{op} < T _{max}	20			
I _{CC}	Supply current (per operator)	No load, V _{out} = 1.75 V	43	55	64	μ A
		T _{min} < T _{op} < T _{max}			66	
AC performance						
GBP	Gain bandwidth product	R _L = 10 k Ω , C _L = 100 pF		2.2		MHz
Gain	Minimum gain for stability	Phase margin = 60 °, R _f = 10 k Ω , R _L = 10 k Ω , C _L = 20 pF		4		V/V
				-3		
SR	Slew rate	R _L = 10 k Ω , C _L = 100 pF, V _{out} = 0.5 V to 2.8 V		0.9		V/ μ s

Micropower (60 μ A), wide bandwidth (2.4 MHz) CMOS op amps

Table 7: Electrical characteristics at VCC+ = 5 V with VCC- = 0 V, Vicm = VCC/2, Tamb = 25 °C, and RL connected to VCC/2 (unless otherwise specified)

Symbol	Parameter	Conditions	Min.	Typ.	Max.	Unit
DC performance						
V _{io}	Offset voltages	TSV639x			3	mV
		TSV639xA			0.8	
		T _{min} < T _{op} < T _{max} , TSV639x			4.5	
		T _{min} < T _{op} < T _{max} , TSV639xA			2	
DV _{io}	Input offset voltage drift		2			μ V/°C
I _{io}	Input offset current, V _{out} = V _{CC} /2			1	10 ⁽¹⁾	pA
		T _{min} < T _{op} < T _{max}		1	100	
I _{ib}	Input bias current, V _{out} = V _{CC} /2			1	10 ⁽¹⁾	pA
		T _{min} < T _{op} < T _{max}		1	100	
CMR	Common mode rejection ratio 20 log (Δ V _{ic} / Δ V _{io})	0 V to 5 V, V _{out} = 2.5 V	60	80		dB
		T _{min} < T _{op} < T _{max}	55			
SVR	Supply voltage rejection ratio 20 log (Δ V _{CC} / Δ V _{io})	V _{CC} = 1.8 to 5 V	75	93		dB
		T _{min} < T _{op} < T _{max}	73			
A _{vd}	Large signal voltage gain	R _L = 10 k Ω , V _{out} = 0.5 V to 4.5 V	89	98		dB
		T _{min} < T _{op} < T _{max}	84			
EMIRR	EMI rejection ratio, EMIRR = -20 log (V _{RFpeak} / Δ V _{io})	V _{RF} = 100 mV _{rms} , f = 400 MHz		61		dB
		V _{RF} = 100 mV _{rms} , f = 900 MHz		85		
		V _{RF} = 100 mV _{rms} , f = 1800 MHz		92		
		V _{RF} = 100 mV _{rms} , f = 2400 MHz		83		
V _{OH}	High-level output voltage, V _{OH} = V _{CC} - V _{out}	R _L = 10 k Ω		7	35	mV
		R _L = 10 k Ω , T _{min} < T _{op} < T _{max}			50	
V _{OL}	Low-level output voltage	R _L = 10 k Ω		6	35	mV
		R _L = 10 k Ω , T _{min} < T _{op} < T _{max}			50	
I _{out}	I _{sink}	V _o = 5 V	40	65		mA
		T _{min} < T _{op} < T _{max}	35			
	I _{source}	V _o = 0 V	40	72		
		T _{min} < T _{op} < T _{max}	35			
I _{CC}	Supply current (per operator)	No load, V _{out} = V _{CC} /2	50	60	69	μ A
		T _{min} < T _{op} < T _{max}			72	
AC performance						
GBP	Gain bandwidth product	R _L = 10 k Ω , C _L = 100 pF		2.4		MHz
Gain	Minimum gain for stability	Phase margin = 60°, R _f = 10 k Ω , R _L = 10 k Ω , C _L = 20 pF,		4		V/V
				-3		
SR	Slew rate	R _L = 10 k Ω , C _L = 100 pF		1.1		V/ μ s

Symbol	Parameter	Conditions	Min.	Typ.	Max.	Unit
e_n	Equivalent input noise voltage	$f = 1 \text{ kHz}$		60		nV/ $\sqrt{\text{Hz}}$
		$f = 10 \text{ kHz}$		33		
THD+N	Total harmonic distortion + noise	$V_{CC} = 5 \text{ V}$, $f_{in} = 1 \text{ kHz}$, $A_{CL} = -10$, $R_L = 100 \text{ k}\Omega$, $V_{icm} = V_{CC}/2$, $BW = 22 \text{ kHz}$, $V_{out} = 1 \text{ V}_{rms}$		0.015		%

Table 8: Shutdown characteristics at $V_{CC} = 5 \text{ V}$

Symbol	Parameter	Conditions	Min.	Typ.	Max.	Unit
DC performance						
I_{CC}	Supply current in shutdown mode (all operators)	$\overline{\text{SHDN}} = V_{CC}^-$		5	50	nA
		$T_{min} < T_{op} < 85 \text{ }^\circ\text{C}$			200	
		$T_{min} < T_{op} < 125 \text{ }^\circ\text{C}$				1.5
t_{on}	Amplifier turn-on time	$R_L = 2 \text{ k}\Omega$, $V_{out} = (V_{CC}^-) \text{ V to } (V_{CC}^-) + 0.2 \text{ V}$		200		ns
t_{off}	Amplifier turn-off time	$R_L = 2 \text{ k}\Omega$, $V_{out} = (V_{CC}^+) - 0.5 \text{ V to } (V_{CC}^+) - 0.7 \text{ V}$		20		
V_{IH}	$\overline{\text{SHDN}}$ logic high		2			V
V_{IL}	$\overline{\text{SHDN}}$ logic low				0.8	V
I_{IH}	$\overline{\text{SHDN}}$ current high	$\overline{\text{SHDN}} = V_{CC}^+$		10		pA
I_{IL}	$\overline{\text{SHDN}}$ current low	$\overline{\text{SHDN}} = V_{CC}^-$		10		
I_{OLeak}	Output leakage in shutdown mode	$\overline{\text{SHDN}} = V_{CC}^-$		50		nA
		$T_{min} < T_{op} < 125 \text{ }^\circ\text{C}$		1		

Electrical characteristic curves

Figure 2: Supply current vs. supply voltage at $V_{icm} = V_{CC}/2$

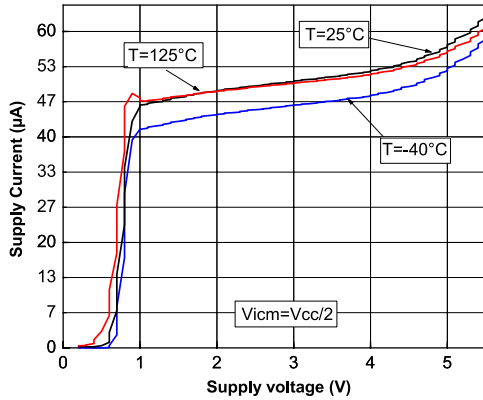

Figure 3: Output current vs. output voltage at $V_{CC} = 1.5$ V

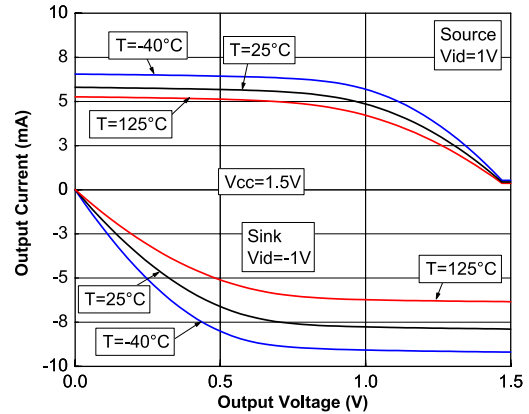

Figure 4: Output current vs. output voltage at $V_{CC} = 5$ V

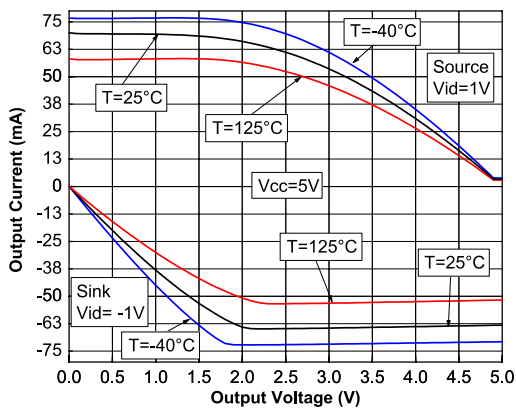

Figure 5: Closed loop response for gain = -10, at $V_{CC} = 1.5$ V and $V_{CC} = 5$ V

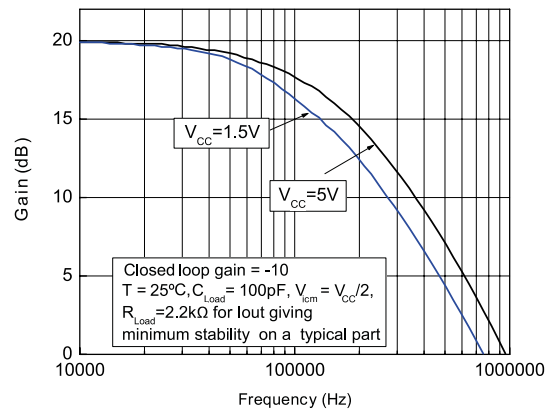

Figure 6: Closed loop response for gain = -3 at $V_{CC} = 1.5$ V

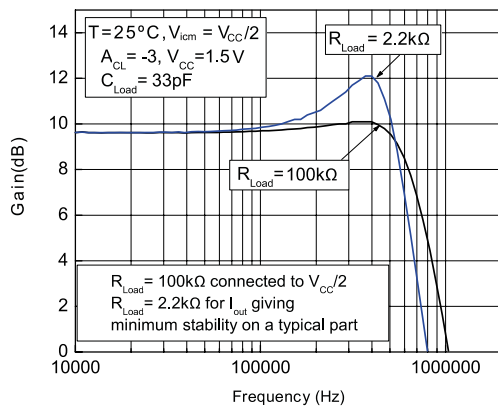

Figure 7: Closed loop response for gain = -3 at $V_{CC} = 5$ V

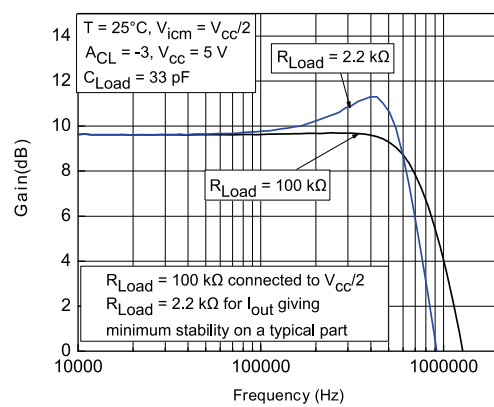

Figure 8: Positive slew rate vs. supply voltage in closed loop

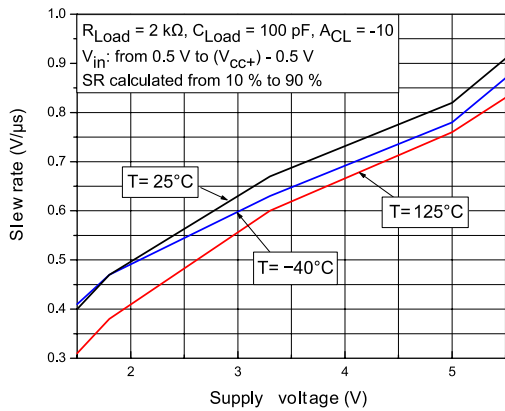

Figure 9: Negative slew rate vs. supply voltage in closed loop

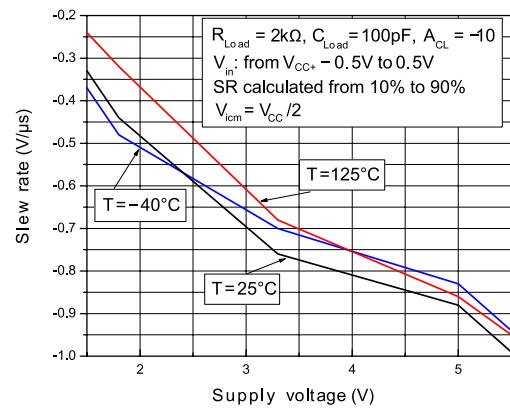

Figure 10: Slew rate vs. supply voltage in open loop

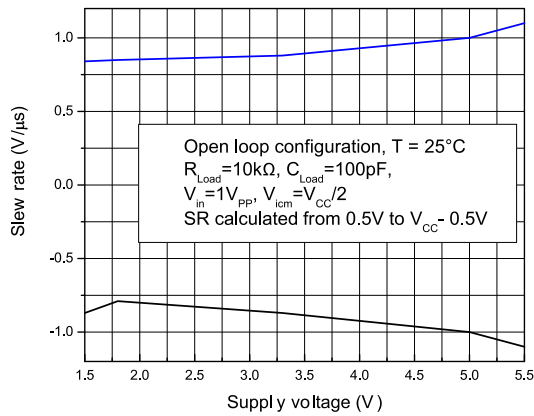

Figure 11: Slew rate timing in open loop

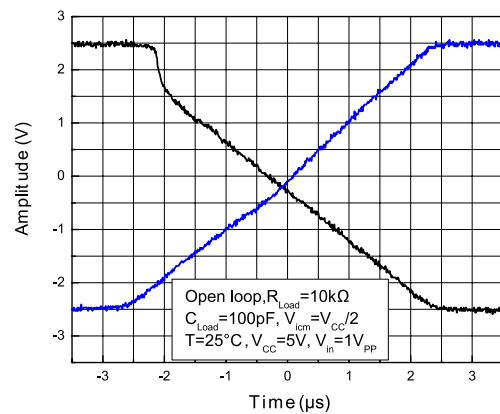

Figure 12: Slew rate timing in closed loop

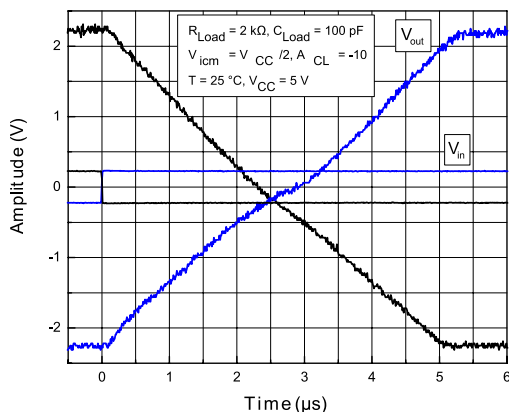

Figure 13: Noise vs. frequency

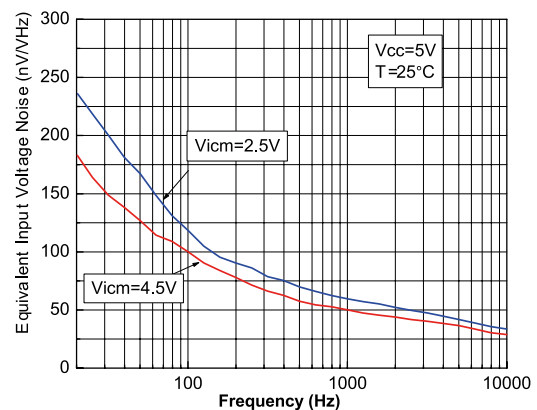

Figure 14: Distortion and noise vs. output voltage at $V_{CC} = 1.8$ V

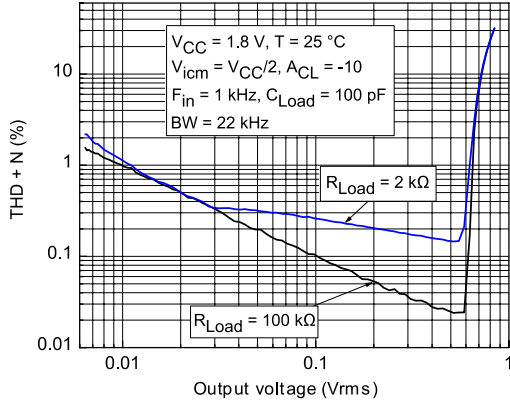

Figure 15: Distortion and noise vs. frequency at $V_{CC} = 1.8$ V

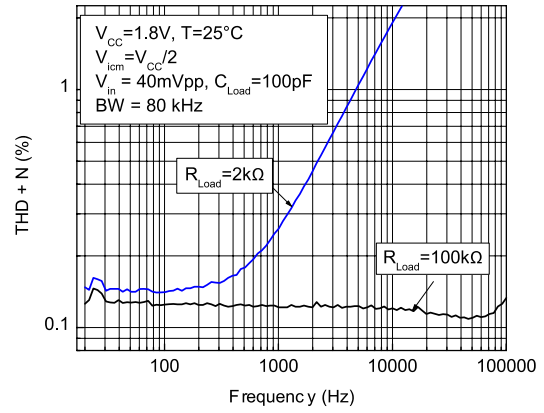

Figure 16: Distortion and noise vs. output voltage at $V_{CC} = 5$ V

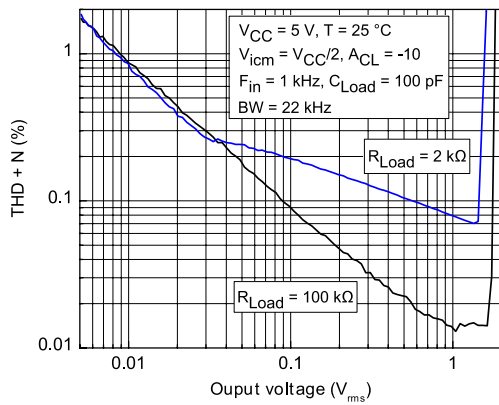

Figure 17: Distortion and noise vs. frequency at $V_{CC} = 5$ V

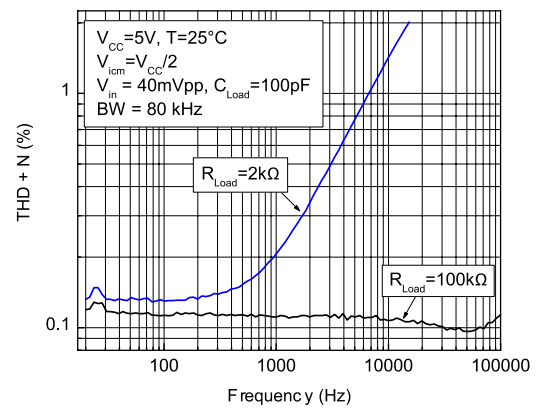

Figure 18: EMIRR vs. frequency at $V_{CC} = 5$ V, $T = 25$ °C

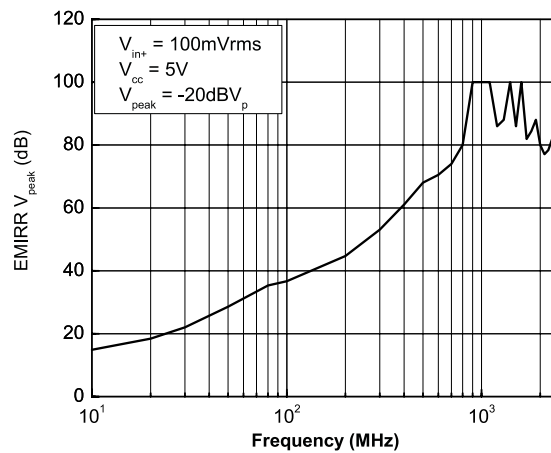

Figure 19: Input offset voltage vs input common-mode at VCC = 1.5 V

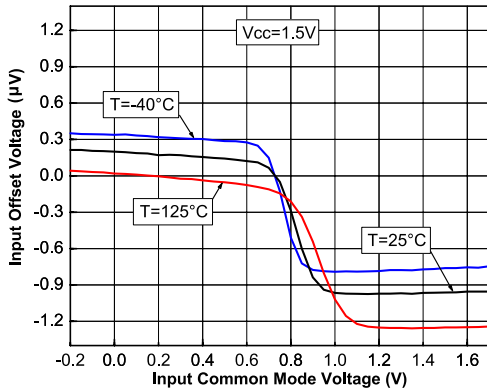

Figure 20: Input offset voltage vs input common-mode at VCC = 5 V

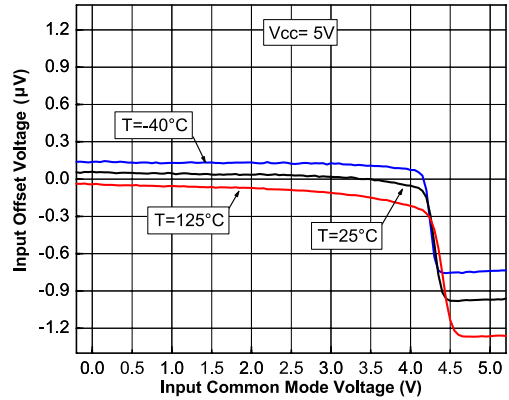

Figure 21: Test configuration for turn-on time (Vout pulled down)

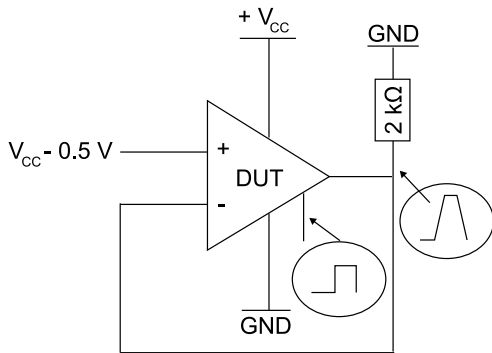

Figure 22: Test configuration for turn-off time (Vout pulled down)

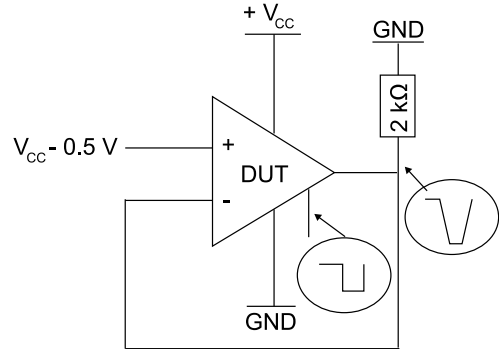

Figure 23: Turn-on time, VCC = 5 V, Vout pulled down, T = 25 °C

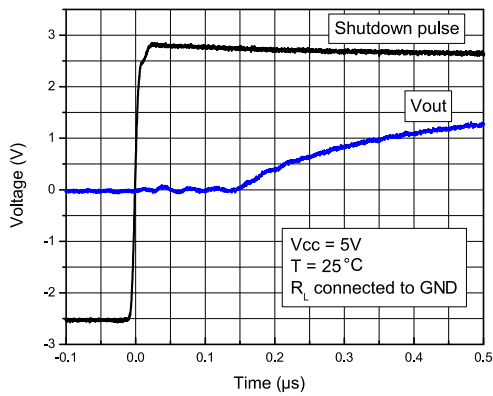
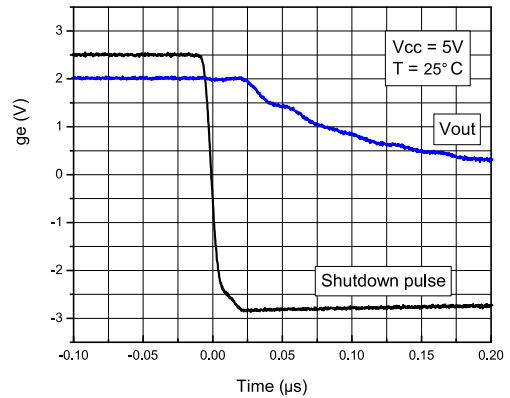
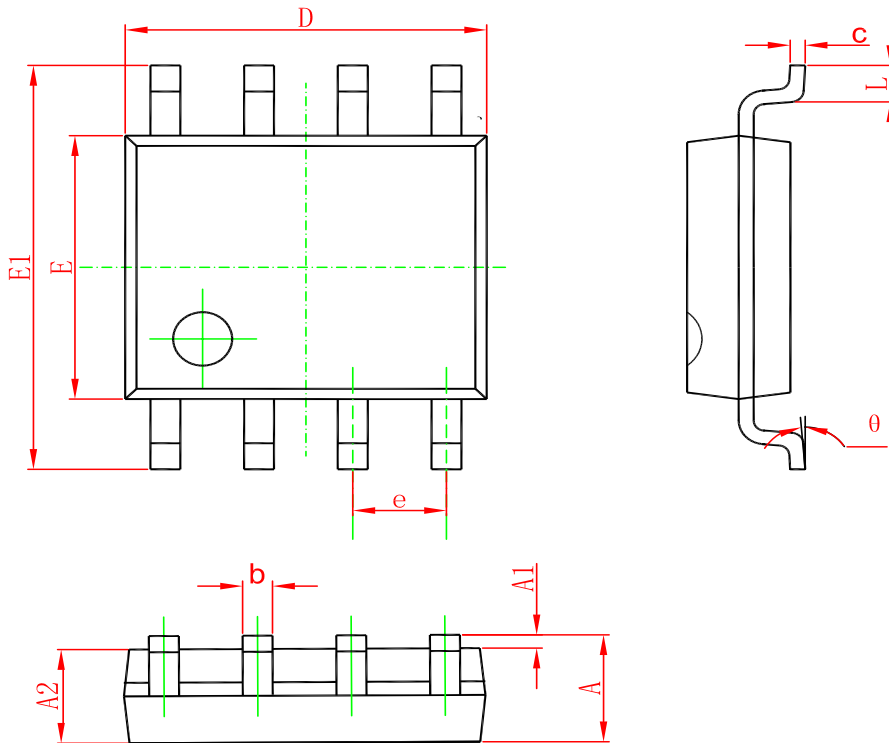

Figure 24: Turn-off time, VCC = 5 V, Vout pulled down, T = 25 °C



SOP-8



Symbol	Dimensions In Millimeters		Dimensions In Inches	
	Min	Max	Min	Max
A	1.350	1.750	0.053	0.069
A1	0.100	0.250	0.004	0.010
A2	1.350	1.550	0.053	0.061
b	0.330	0.510	0.013	0.020
c	0.170	0.250	0.006	0.010
D	4.700	5.100	0.185	0.200
E	3.800	4.000	0.150	0.157
E1	5.800	6.200	0.228	0.244
e	1.270(BSC)		0.050(BSC)	
L	0.400	1.270	0.016	0.050
theta	0°	8°	0°	8°

TSSOP-14

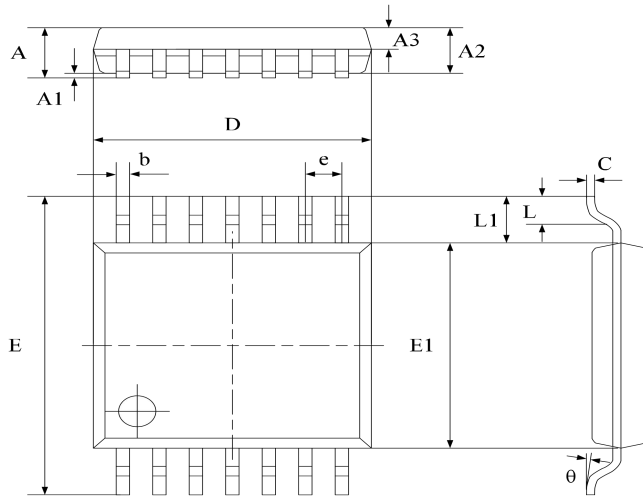

Symbol	Dimensions In Millimeters		Dimensions In Inches	
	Min	Max	Min	Max
A	-	1.200	-	0.0472
A1	0.050	0.150	0.002	0.006
A2	0.900	1.050	0.037	0.043
A3	0.390	0.490	0.016	0.020
b	0.200	0.290	0.008	0.012
C	0.130	0.180	0.005	0.007
D	4.860	5.060	0.198	0.207
E	6.200	6.600	0.253	0.269
E1	4.300	4.500	0.176	0.184
e	0.650 typ.		0.0256 typ.	
L1	1.000 ref.		0.0393 ref.	
L	0.450	0.750	0.018	0.031
θ	0°	8°	0°	8°

Ordering information

Order code	Package	Baseqty	Deliverymode	Marking
UMW TSV6392AIDT	SOP-8	2500	Tape and reel	V632AI
UMW TSV6392IDT	SOP-8	2500	Tape and reel	V6392I
UMW TSV6394IPT	TSSOP-14	4000	Tape and reel	TSV6394
UMW TSV6394AIPT	TSSOP-14	4000	Tape and reel	TSV6394