

Title	<i>Reference Design Report for a 12 W Power Supply Using TinySwitch™-4 TNY288PG</i>
Specification	85 VAC – 265 VAC Input, 12 V, 1 A Output
Application	TinySwitch-4 Reference Design
Author	Applications Engineering Department
Document Number	RDR-839
Date	July 29, 2020
Revision	1.2

Summary and Features

- EcoSmart™ – meets all existing and proposed energy efficiency standards including ErP.
 - No-load consumption <30 mW; more than 300 mW available in stand-by with 500 mW input
 - > 84% average active-mode efficiency – DOE6 and EC CoC (v5)
- The board can fit P/G or the cost-effective D package
- BP/M capacitor value selects power MOSFET current limit for greater design flexibility
- Accurate detection output overvoltage protection (OVP) using primary bias winding sensed shutdown feature
- Accurately tolerated I²f parameter (-10%, +12%) reduces system cost
 - Increases MOSFET and magnetics power delivery
 - Reduces overload power, which lowers output diode and capacitor costs
- Integrated TinySwitch-4 safety / reliability features
 - Accurate (±5%), auto-recovering, hysteretic thermal shutdown function maintains safe PCB temperatures under all conditions
 - Auto-restart protects against output short-circuit and open loop fault conditions
 - P and G package with >3.2 mm creepage on package enables reliable operation in high humidity and high pollution environments
- Meets EN55022 and CISPR-22 Class B conducted EMI with >12 dBμV margin
- Meets IEC61000-4-5 Class 3 AC line surge

Power Integrations

5245 Hellyer Avenue, San Jose, CA 95138 USA.
 Tel: +1 408 414 9200 Fax: +1 408 414 9201
www.power.com

PATENT INFORMATION

The products and applications illustrated herein (including transformer construction and circuits external to the products) may be covered by one or more U.S. and foreign patents, or potentially by pending U.S. and foreign patent applications assigned to Power Integrations. A complete list of Power Integrations' patents may be found at www.power.com. Power Integrations grants its customers a license under certain patent rights as set forth at <https://www.power.com/company/intellectual-property-licensing/>.



Table of Contents

1	Introduction	5
2	Power Supply Specification	6
3	Schematic	7
4	Circuit Description	8
4.1	Input Rectifier and Filter	8
4.2	TNY288PG Operation	8
4.3	Output Rectification and Filtering	9
4.4	Feedback and Output Voltage Regulation	9
4.5	Output Overvoltage Shutdown	9
4.6	Undervoltage Lockout	9
4.7	EMI Design Aspects	10
4.8	ESD Design Aspects	10
5	PCB Layout	11
6	Bill of Materials	12
7	Transformer Specification	13
7.1	Electrical Diagram	13
7.2	Electrical Specifications	13
7.3	Material List	13
7.4	Transformer Build Diagram	14
7.5	Transformer Instructions	14
7.6	Transformer Winding Illustrations	15
9	Transformer Design Spreadsheet	19
10	Performance Data	22
10.1	Efficiency	22
10.1.1	Active Mode Measurement Data	22
10.1.2	Full Load Efficiency vs. Line	23
10.1.3	Efficiency vs. Load	24
10.2	Available Standby Output Power	25
10.3	No-Load Input Power	27
10.4	Line Regulation	28
10.5	Load Regulation	29
11	Waveforms	30
11.1	Load Transient Response	30
11.1.1	0% - 100% Load Change	30
11.1.2	50% - 100% Load Change	31
11.2	Output Voltage at Start-up	32
11.2.1	CC Mode	32
11.2.2	CR Mode	34
11.3	Switching Waveforms	36
11.3.1	Primary MOSFET Drain-Source Voltage and Current at Normal Operation	36
11.3.2	Primary MOSFET Drain-Source Voltage and Current at Start-up Operation	38
11.3.3	Output Diode Voltage and Current at Normal Operation	40
11.3.4	Output Diode Voltage and Current at Start-up Operation	42

11.4	Brown-In and Brown-Out	44
11.4.1	Without UV Sensing	44
11.4.2	With UV sensing	44
11.5	Fault Conditions.....	45
11.5.1	Output Overvoltage.....	45
11.5.2	Output Short Circuit	49
11.5.3	Output Overload	50
11.6	Output Voltage Ripple	52
11.6.1	Ripple Measurement Technique	52
11.6.2	Measurement Results	53
11.6.3	Output Ripple Voltage Graph from 0% - 100%	58
12	Thermal Performance.....	59
12.1	Test Set-Up.....	59
12.2	Thermal Performance at Room Temperature	60
12.2.1	85 VAC at room temperature	60
12.2.2	265 VAC at Room Temperature.....	61
12.3	Thermal Performance at 50 °C	62
12.3.1	85 VAC at 50 °C.....	62
12.3.2	265 VAC at 50 °C.....	63
12.4	Over Temperature Protection	64
12.4.1	OTP at 85 VAC.....	64
12.4.2	OTP at 265 VAC	65
13	Conducted EMI	66
13.1	Test Set-up Equipment	66
13.1.1	Equipment and Load Used	66
13.2	Test Set-up	66
13.3	Test Results	67
14	Line Surge.....	68
14.1	Differential and Common Mode Surge	68
14.2	Ring Wave	69
14.3	Electrical Fast Transient (EFT)	70
15	ESD.....	71
16	Revision History	72

Important Note: Although this board is designed to satisfy safety isolation requirements, the engineering prototype has not been agency approved. Therefore, all testing should be performed using an isolation transformer to provide the AC input to the prototype board.



1 Introduction

This engineering report describes an isolated flyback converter designed to provide a nominal output voltage of 12 V at 1 A load from a wide input voltage range of 85 VAC to 265 VAC. This adapter utilizes the TNY288P from the TinySwitch-4 family of ICs, with provision for D and K packages placed on the top layer.

This document contains the complete power supply specifications, bill of materials, transformer construction, circuit schematic and printed circuit board layout, along with performance data and electrical waveforms.



Figure 1 – Populated Circuit Board, Top View.

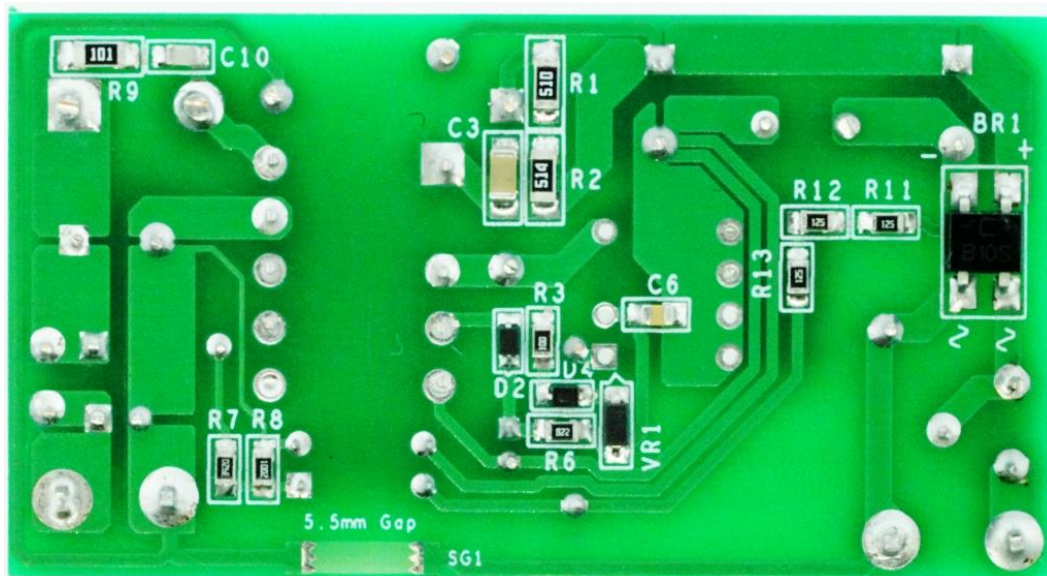

Figure 2 – Populated Circuit Board, Bottom View.

2 Power Supply Specification

The table below represents the minimum acceptable performance of the design. Actual performance is listed in the results section.

Description	Symbol	Min	Typ	Max	Units	Comment
Input						
Voltage	V_{IN}	85		265	VAC	2 Wire – no P.E.
Frequency	f_{LINE}	47	50/60	64	Hz	
No-load Input Power (230 VAC)				0.15	W	With Bias Winding Support.w/o
No-load Input Power (230 VAC)				0.030	W	UVLO Resistor or Bias Winding.
Output						
Output Voltage	V_{OUT}	11	12	13	V	± 8%
Output Ripple Voltage	V_{RIPPLE}			100	mV	20 MHz Bandwidth.
Output Current	I_{OUT}			1	A	
Total Output Power						
Continuous Output Power	P_{OUT}			12	W	
Overvoltage Shutdown	V_{OV}	14		16	V	With Bias Sense.
Efficiency						
Full Load	η	84			%	Measured at P_{OUT} 25 °C
Required average efficiency at 25, 50, 75 and 100 % of P_{OUT}	η_{DOE}	83			%	Per DOE EISA2007 (Level VI) with TNY278 & Standard Current Limit
Environmental						
Conducted EMI		Meets CISPR22B / EN55022B				
Safety		Designed to meet IEC950, UL1950 Class II				
Surge (Differential)				1	kV	1.2/50 μ s surge, IEC 1000-4-5, Series Impedance:
Surge (Common mode)				2	kV	Differential Mode: 2 Ω
Ring Wave				3	kV	Common Mode: 12 Ω
Electrical Fast Transient				4	kV	
ESD				±15	kV	Air Discharge.
				±8	kV	Contact Discharge.
Ambient Temperature	T_{AMB}	0		50	°C	Free Convection, Sea Level.

3 Schematic

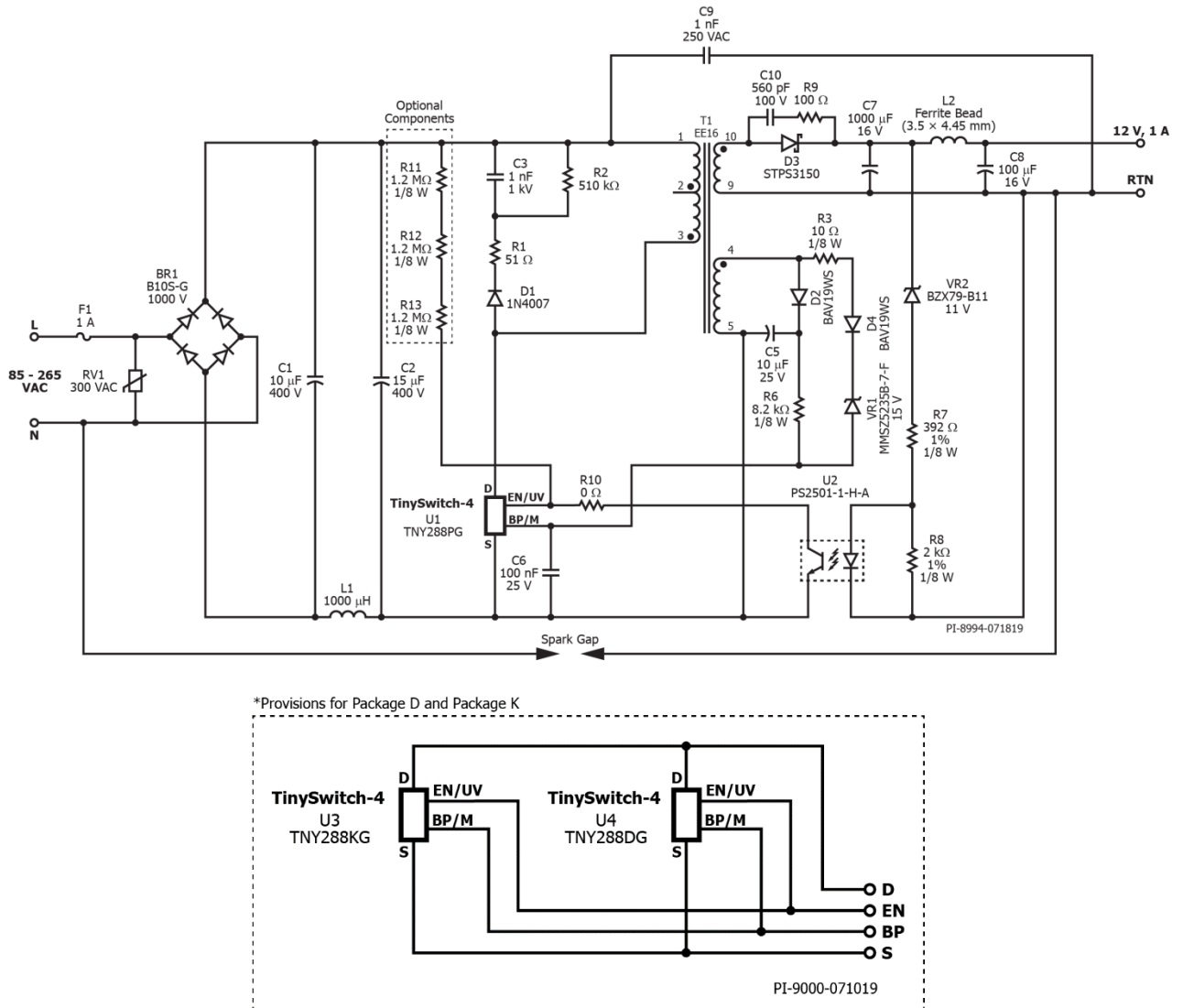

Figure 3 – Schematic.

4 Circuit Description

This circuit is configured as a flyback topology power supply utilizing the TNY288PG. Secondary-side constant voltage (CV) regulation is accomplished through optocoupler feedback with a Zener reference.

4.1 *Input Rectifier and Filter*

The AC input voltage is rectified by input bridge BR1. The rectified DC is then filtered by the bulk storage capacitors C1 and C2. Inductor L1, C1 and C2 form an input pi filter, which attenuates differential mode conducted EMI.

4.2 *TNY288PG Operation*

The TNY288PG device U1 integrates the power switching device, oscillator, control, startup, and protection functions.

The rectified and filtered input voltage is applied to the primary winding of T1. One side of the power transformer (T1) primary winding is connected to the positive leg of C2, and the other side is connected to the DRAIN (D) pin of U1. At the start of a switching cycle, the controller turns the power MOSFET on and current ramps up in the primary winding, delivering energy from bulk capacitor to transformer. When that current reaches the limit threshold, the controller turns the power MOSFET off. Due to the phasing of the transformer windings and the orientation of the output diode, the stored energy is delivered to the output capacitor during off time.

When the power MOSFET turns off, the leakage inductance of the transformer induces a voltage spike on the drain node. The amplitude of that spike is limited by an RCD clamp network that consists of D1, C3, R2 and R1. Resistor R2 and R1 not only damp the high frequency leakage ring that occurs when the power MOSFET turns off, but also limit the reverse current through D1 when the power MOSFET turns on. This allows a slow, low-cost, glass passivated diode (with a recovery time of $\leq 2 \mu\text{s}$.) to be used for D1. The slow diode also improves conducted EMI and efficiency.

Using ON/OFF control, U1 skips switching cycles to regulate the output voltage, based on feedback to its ENABLE/UNDERVOLTAGE (EN/UV) pin. The EN/UV pin current is sampled, just prior to each switching cycle, to determine if that switching cycle should be enabled or disabled. If the EN/UV pin current is $< 115 \mu\text{A}$, the next switching cycle begins, and is terminated when the current through the power MOSFET reaches the internal current limit threshold. To evenly spread switching cycles, preventing group pulsing, the EN/UV pin threshold current is modulated between $115 \mu\text{A}$ and $60 \mu\text{A}$ based on the state during the previous cycle. An internal state machine sets the current limit to one of 4 levels appropriate for the operating conditions, ensuring that the switching frequency remains above the audible range until the transformer flux density is low enough to prevent audible noise. This practically eliminates audible noise when standard dip varnishing of the transformer is used.



4.3 **Output Rectification and Filtering**

Output rectification is provided by D3. Low ESR capacitor C7 achieves minimum output voltage ripple and noise in a small can size for the rated ripple current specification. A post filter (ferrite bead L2 and C8) attenuates noise and ripple further to meet the specification.

4.4 **Feedback and Output Voltage Regulation**

The supply's output voltage regulation set point is set by the voltage that develops across Zener diode VR2, R7 and the LED in optocoupler U2. The value of R8 was calculated to bias VR2 to about 0.5 mA when it goes into reverse avalanche conduction. This ensures that it is operating close to its rated knee current. Resistor R7 limits the maximum current during load transients. The values of R7 and R8 can both be varied slightly to fine-tune the output regulation set point. When the output voltage rises above the set point, the LED in U2 becomes forward biased. On the primary-side, the photo-transistor of U2 turns on and draws current out of the EN/UV pin of U1. Just before the start of each switching cycle, the controller checks the EN/UV pin current. If the current flowing out of the EN/UV pin is greater than 115 μ A, that switching cycle will be disabled. As switching cycles are enabled and disabled, the output voltage is kept very close to the regulation set point. For greater output voltage regulation accuracy, a reference IC such as a TL431 can be used in place of VR2.

4.5 **Output Overvoltage Shutdown**

PI's proprietary primary overvoltage detection eliminates the use additional opto-coupler and enables to low voltage rated output. It is accomplished by sensing the switching bias winding voltage during power MOSFET off time. When the power MOSFET is off, the reflected voltage on the bias winding is proportional to the output voltage by a factor determined by the bias and output turns ratio. When this voltage exceeds the sum of VR1, forward voltage of D4, and the BYPASS (BP) pin voltage, an overvoltage condition occurs and current begins to flow into the BYPASS pin. When this current exceeds 5 mA the internal shutdown circuit in U1 is activated. Reset is accomplished by removing input power and allowing the BYPASS pin voltage to drop below 2 V. Resistor R3 can be used to fine tune the overvoltage limit.

4.6 **Undervoltage Lockout**

Undervoltage (UV) lockout detection is accomplished by sensing the rectified dc voltage thru resistors R11, R12 and R13. When installed, power MOSFET switching is disabled at start-up until the current into the EN/UV pin exceeds 25 μ A. This allows the designer to set the input voltage at which MOSFET switching will be enabled by choosing the sum of R11 – R13. For example, a value of 3.6 M Ω requires an input voltage of 65 VAC (92 VDC across C2) before the current into the EN/UV pin exceeds 25 μ A. The UV detect function also prevents the output of the power supply from glitching (trying to restart) after output regulation is lost (during shutdown), by disabling power MOSFET switching until the input voltage rises above the undervoltage lockout threshold.

4.7 ***EMI Design Aspects***

In addition to the simple input π filter (C1, L1 and C2) for differential mode EMI, this design makes use of shielding techniques in the transformer to reduce common mode EMI displacement currents. Resistor R2 and capacitor C3 are added to act as damping network to reduce high frequency transformer ringing. These techniques combined with the frequency jitter of TNY288PG gives excellent conducted and radiated EMI performance.

4.8 ***ESD Design Aspects***

Component placement and board layout play a crucial role in order to pass ESD compliance requirements. The following design considerations were applied in this reference board:

- Place C6 as close as possible and directly to BP and SOURCE pins.
- Separate the ground trace of U2 from the ground trace of C5. The two ground traces can be merged at the bulk capacitor C2 ground pin. This minimizes coupling of ESD.
- Route Y capacitor C9 traces directly to bulk capacitor C2 positive pin, and the other end to directly to RTN terminal
- Route the spark gap between RTN terminal and Neutral terminal

5 PCB Layout

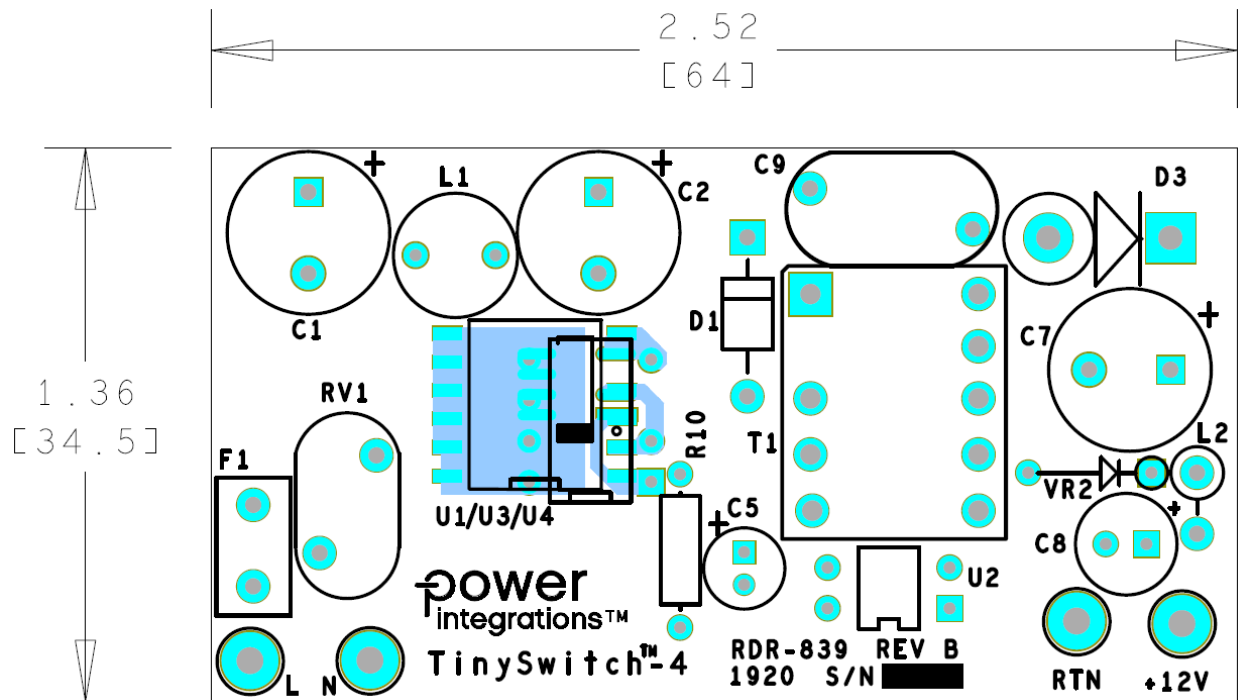

Figure 4 – Populated Circuit Board, Top View.

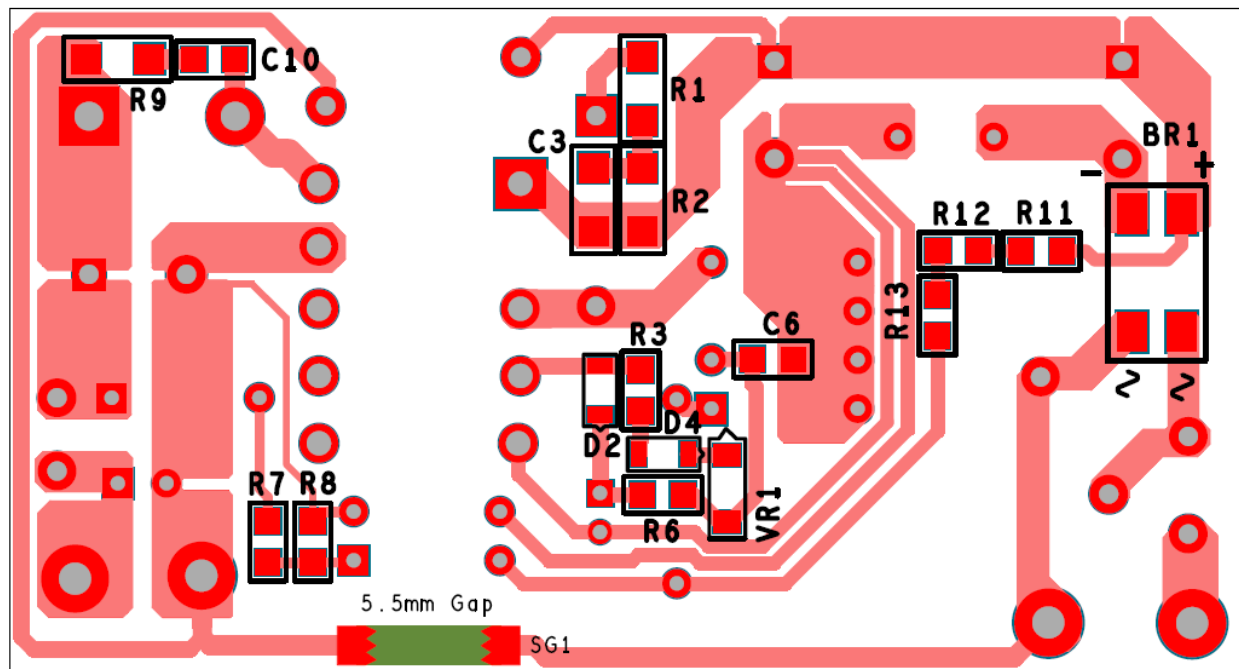

Figure 5 – Populated Circuit Board, Bottom View.



6 Bill of Materials

Item	Qty	Ref Des	Description	Mfg Part Number	Mfg
1	1	BR1	1000 V, 0.8 A, Bridge Rectifier, SMD, MBS-1, 4-SOIC	B10S-G	Comchip
2	1	C1	10 μ F, \pm 20%, 400 V, Electrolytic, (10 x 14.5)	UVC2G100MPD	Nichicon
3	1	C2	15 μ F, 400 V, Electrolytic, (10 x 16)	UVC2G150MPD	Nichicon
4	1	C3	1 nF, 1000 V, Ceramic, X7R, 1206	CC1206KKX7RCBB102	Yageo
5	1	C5	10 μ F, 25 V, Electrolytic, Gen. Purpose, (5 x 12)	ECA-1EM100	Panasonic
6	1	C6	100 nF, 25 V, Ceramic, X7R, 0805	08053C104KAT2A	AVX
7	1	C7	1000 μ F, 16 V, Electrolytic, Very Low ESR, 23 m Ω , (10 x 20)	EKZE160ELL102MJ20S	Nippon Chemi-Con
8	1	C8	100 μ F, 16 V, Electrolytic, Low ESR, 250 m Ω , (6.3 x 11.5)	ELXZ160ELL101MFB5D	Nippon Chemi-Con
9	1	C9	1 nF, Ceramic, Y1	440LD10-R	Vishay
10	1	C10	560 pF, \pm 5%, 100 V, General Purpose, Ceramic Capacitor, COG, NP0, 0805	CC0805JRNPO0BN561	Yageo
11	1	D1	1000 V, 1 A, Rectifier, DO-41	1N4007-E3/54	Vishay
12	2	D2 D4	100 V, 0.2 A, Fast Switching, 50 ns, SOD-323	BAV19WS-7-F	Diodes, Inc.
13	1	D3	150 V, 3 A, Schottky, DO-201AD	STPS3150RL	ST
14	1	F1	1 A, 250 V, Slow, Long Time Lag, RST 1	RST 1	Belfuse
15	1	L1	1000 μ H, 0.3 A	RLB0914-102KL	Bourns
16	1	L2	3.5 mm x 4.45 mm, 56 Ω at 100 MHz, #22 AWG hole, Ferrite Bead	2761001112	Fair-Rite
17	1	R1	RES, 51 Ω , 5%, 1/4 W, Thick Film, 1206	ERJ-8GEYJ510V	Panasonic
18	1	R2	RES, 510 k Ω , 5%, 1/4 W, Thick Film, 1206	ERJ-8GEYJ514V	Panasonic
19	1	R3	RES, 10 Ω , 5%, 1/8 W, Thick Film, 0805	ERJ-6GEYJ100V	Panasonic
20	1	R6	RES, 8.2 k Ω , 5%, 1/8 W, Thick Film, 0805	ERJ-6GEYJ822V	Panasonic
21	1	R7	RES, 392 Ω , 1%, 1/8 W, Thick Film, 0805	ERJ-6ENF3920V	Panasonic
22	1	R8	RES, 2.00 k Ω , 1%, 1/8 W, Thick Film, 0805	ERJ-6ENF2001V	Panasonic
23	1	R9	RES, 100 Ω , 5%, 1/4 W, Thick Film, 1206	ERJ-8GEYJ101V	Panasonic
24	1	R10	RES, 0 Ω , 5%, 1/4 W, Carbon Film	ZOR-25-B-52-0R	Yageo
25	3	R11 R12 R13	RES, 1.2 M Ω , 5%, 1/8 W, Thick Film, 0805	ERJ-6GEYJ125V	Panasonic
26	1	RV1	300 VAC, 25 J, 7 mm, RADIAL	V300LA4P	Littlefuse
27	1	T1	Bobbin, EE16 Vertical, 10 pins Transformer	YW-527-00B PNY-83912	Yih-Hwa Premier Magnetics
28	1	U1	TinySwitch-4, TNY288PG, DIP-8C	TNY288PG	Power Integrations
29	1	U2	Optocoupler, 80 V, CTR 80-160%, 4-DIP	PS2501-1-H-A	CEL
30	1	VR1	DIODE ZENER 6.8 V 500 mW SOD123	MMSZ5235B-7-F	Diodes, Inc.
31	1	VR2	11 V, 500 mW, 2%, DO-35	BZX79-B11,133	NXP Semi
32	1	+12V	Test Point, RED, THRU-HOLE MOUNT	5010	Keystone
33	2	N RTN	Test Point, BLK, THRU-HOLE MOUNT	5011	Keystone
34	1	L	Test Point, WHT, THRU-HOLE MOUNT	5012	Keystone

7 Transformer Specification

7.1 Electrical Diagram

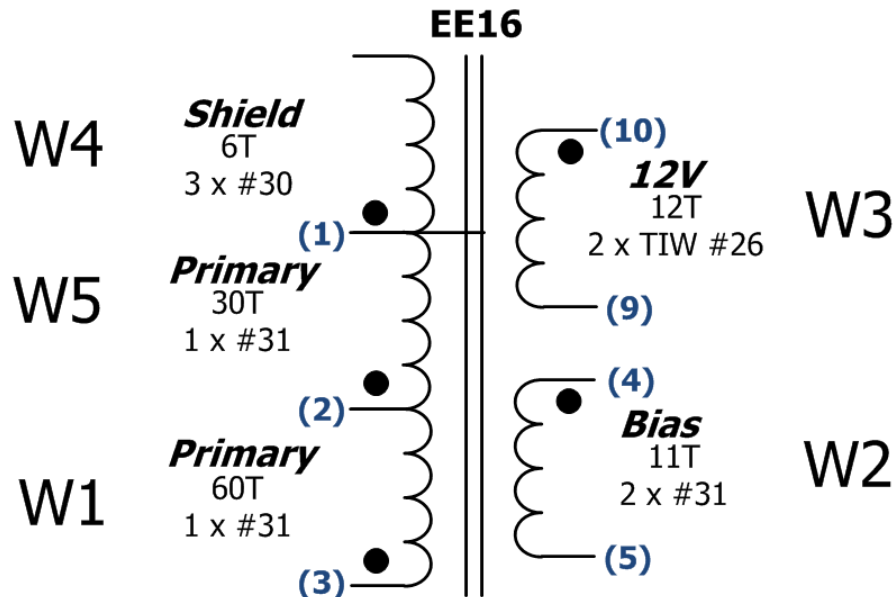

Figure 6 – Transformer Electrical Diagram.

7.2 Electrical Specifications

Parameter	Condition	Spec.
Nominal Primary Inductance	Measured at 1 V _{PK-PK} , 100 kHz switching frequency, between pin 1 and pin 3 with all other windings open.	860 μ H
Tolerance	Tolerance of Primary Inductance.	$\pm 10\%$
Leakage Inductance	Measured across primary winding with all other windings shorted.	<20 μ H

7.3 Material List

Item	Description
[1]	Core: EE16 PC44.
[2]	Bobbin: EE16, Vertical, 10 Pins. PI#: 25-00970-00.
[3]	Magnet Wire: #31 AWG.
[4]	Magnet Wire: #30 AWG.
[5]	Tripe Insulated Wire: #26.
[6]	Polyester Tape: 9 mm.
[7]	Polyester Tape: 5 mm.
[8]	Varnish: Dolph BC 359 or equivalent.

7.4 **Transformer Build Diagram**

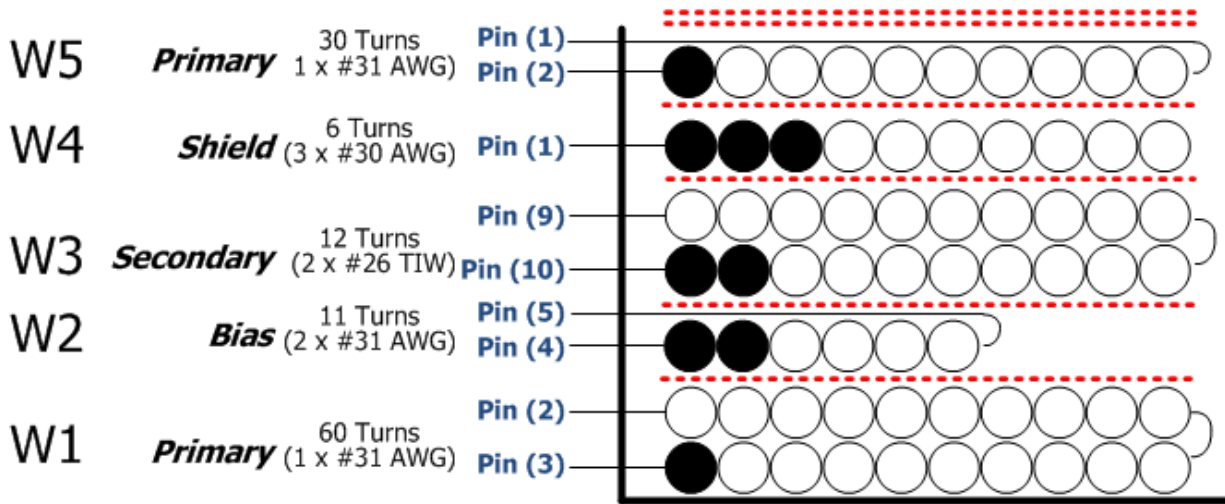
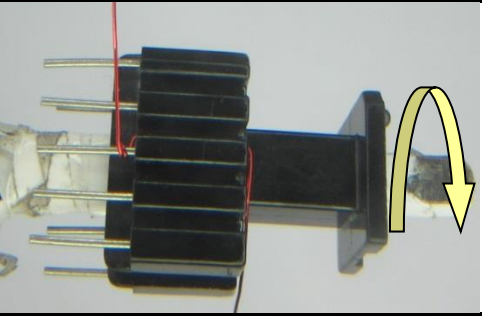
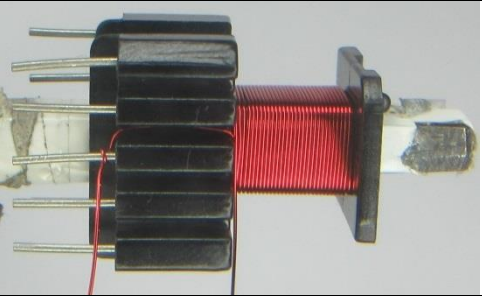
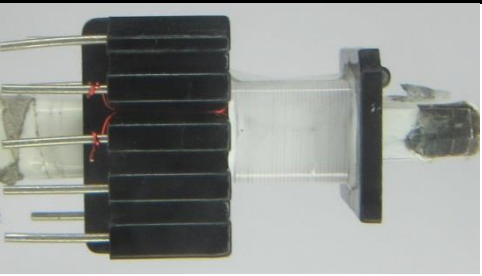
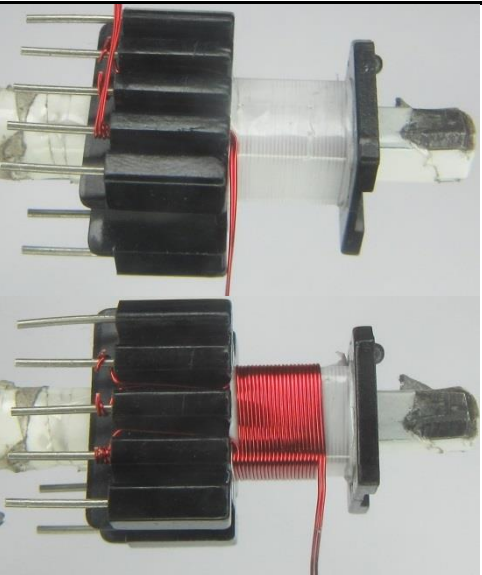

Figure 7 – Transformer Build Diagram.

7.5 **Transformer Instructions**

Winding Preparation	Place the bobbin Item [2] with the pins facing the winder. Winding direction is counter-clockwise as shown.
W1 1st Primary	Start at pin 3. Wind 60 turns of wire Item [3] in two layers. After the last turn, bring the wire back across the windings into pin 2.
Insulation	Place one layer of tape Item [6] for insulation.
W2 Bias	Start at pin 4. Wind 11 turns of two strands of wire Item [3] in one layer. Wind all turns on tightly on one side. Bring the back into pin 5.
Insulation	Place one layer of tape Item [6] for insulation.
W3 Secondary	Start at pin 10. Wind 12 turns of two strands of wire Item [5] in two layers. Finish at pin 9.
Insulation	Place one layer of tape Item [6] for insulation.
W4 Shield	Start at pin 1. Wind 6 turns of three strands of wire Item [4] in one layer. Spread the turns evenly across the bobbin. The end of the last turn is no-connect (NC).
Insulation	Place one layer of tape Item [6] for insulation.
W5 2nd Primary	Start at pin 2. Wind 30 turns of wire Item [3] in one layer. After the last turn, bring the wire back across the windings into pin 1.
Insulation	Place one layer of tape Item [6] for insulation.
Assembly	Grind core halves for specified primary inductance. Place a floating wire along the core, and solder one end to pin 1. Wrap core halves and floating wire with tape Item [7]. Remove pin 2. Varnish with Item [8].

7.6 **Transformer Winding Illustrations**

<p>Winding Preparation</p>		<p>Place the bobbin Item [2] with the pins facing the winder. Winding direction is counter-clockwise as shown.</p>
<p>W1 1st Primary</p>		<p>Start at pin 3. Wind 60 turns of wire Item [3] in two layers. End at pin 2.</p>
<p>Insulation</p>		<p>Place one layer of tape Item [6] for insulation.</p>
<p>W2 Bias</p>		<p>Start at pin 4. Wind 11 turns of two strands of wire Item [3] in one layer. Wind all turns on tightly on one side. Bring the back into pin 5.</p>

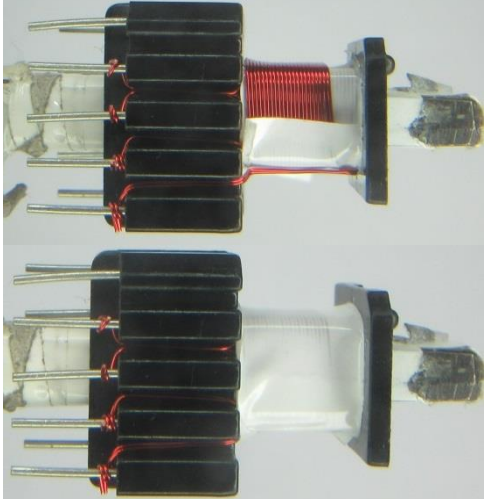
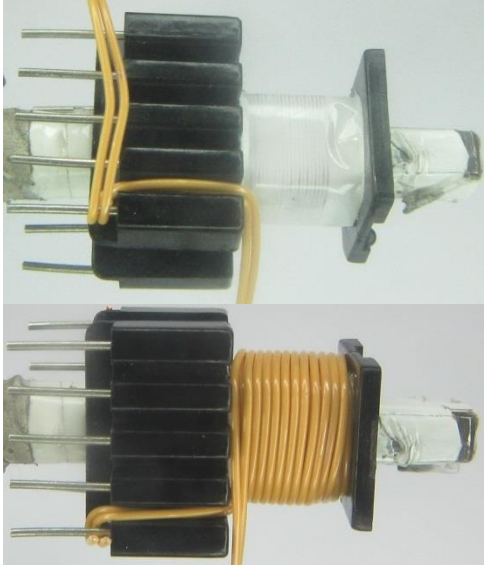
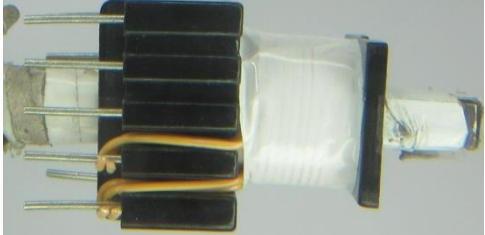
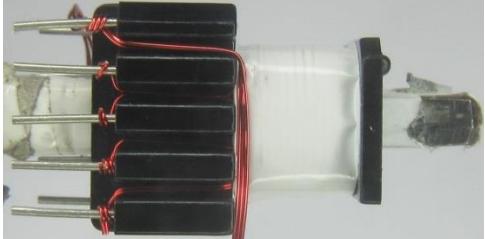
<p>Insulation</p>		<p>Place one layer of tape Item [6] for insulation.</p>
<p>W3 Secondary</p>		<p>Start at pin 10. Wind 12 turns of two strands of wire Item [5] in two layers. Finish at pin 9.</p>
<p>Insulation</p>		<p>Place one layer of tape Item [6] for insulation.</p>
<p>W4 Shield</p>		<p>Start at pin 1. Wind 6 turns of three strands of wire Item [4] in one layer. Spread the turns evenly across the bobbin. The end of the last turn is no connect (NC).</p>

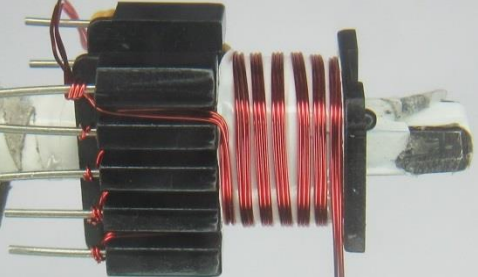
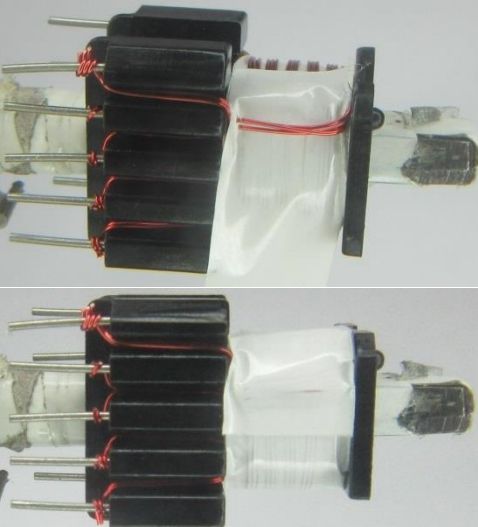
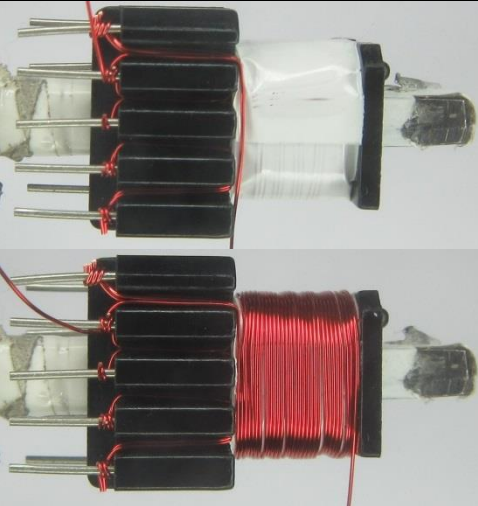
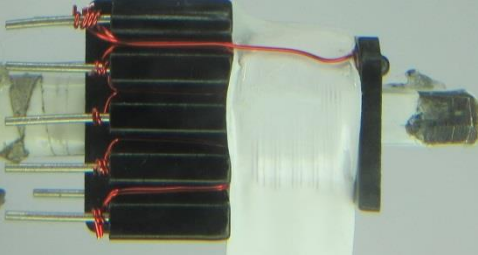
		
<p>Insulation</p>		<p>Place one layer of tape Item [6] for insulation</p>
<p>W5 2nd Primary</p>		<p>Start at pin 2. Wind 30 turns of wire Item [3] in one layer. After the last turn, bring the wire back across the windings into pin 1.</p>
<p>Insulation</p>		<p>Place two layers of tape Item [6] for insulation</p>

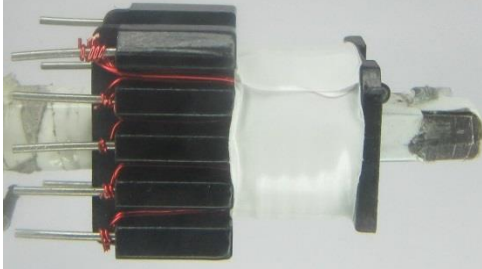
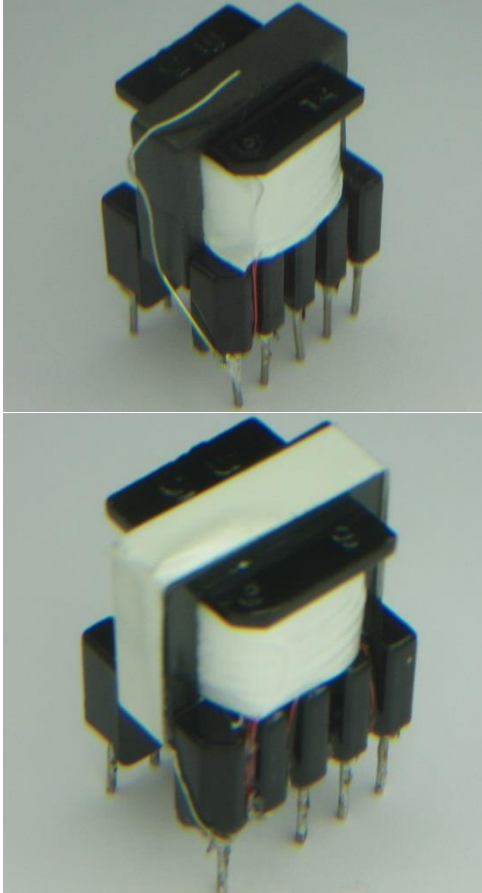
		
Assembly		<p>Grind core halves for specified primary inductance.</p> <p>Place a floating wire along the core, and solder one end to pin 1.</p> <p>Wrap core halves and floating wire with tape Item [7].</p> <p>Remove pin 2. Varnish with Item [8].</p>

9 Transformer Design Spreadsheet

ACDC_TinySwitch-4_110618; Rev.1.2; Copyright Power Integrations 2018	INPUT	INFO	OUTPUT	UNIT	ACDC_TinySwitch-4_110618_Rev1-2.xls; TinySwitch-4 Continuous/Discontinuous Flyback Transformer Design Spreadsheet
ENTER APPLICATION VARIABLES					
VACMIN	85		85	Volts	Minimum AC Input Voltage
VACMAX	265		265	Volts	Maximum AC Input Voltage
fL	50		50	Hertz	AC Mains Frequency
VO	12.00		12.00	Volts	Output Voltage (at continuous power)
IO	1.00		1.00	Amps	Power Supply Output Current (corresponding to peak power)
Power			12.00	Watts	Continuous Output Power
n	0.84		0.84		Efficiency Estimate at output terminals. Under 0.7 if no better data available
Z	0.50		0.50		Z Factor. Ratio of secondary side losses to the total losses in the power supply. Use 0.5 if no better data available
tC			3.00	mSeconds	Bridge Rectifier Conduction Time Estimate
CIN	25.00		25.00	uFarads	Input Capacitance
ENTER TinySwitch-4 VARIABLES					
TinySwitch-4	TNY288D		TNY288D		User-defined TinySwitch-4
Chose Configuration	STD		Standard Current Limit		Enter "RED" for reduced current limit (sealed adapters), "STD" for standard current limit or "INC" for increased current limit (peak or higher power applications)
ILIMITMIN			0.512	Amps	Minimum Current Limit
ILIMITTYP			0.55	Amps	Typical Current Limit
ILIMITMAX			0.588	Amps	Maximum Current Limit
fSmin			124000	Hertz	Minimum Device Switching Frequency
I ² fmin			35.937	A ² kHz	I ² f (product of current limit squared and frequency is trimmed for tighter tolerance)
VOR	95.6		95.6	Volts	Reflected Output Voltage (VOR < 135 V Recommended)
VDS			10.0	Volts	TinySwitch-4 on-state Drain to Source Voltage
VD			0.70	Volts	Output Winding Diode Forward Voltage Drop
KP			0.75		Ripple to Peak Current Ratio (KP < 6)
KP_TRANSIENT			0.44		Transient Ripple to Peak Current Ratio. Ensure KP_TRANSIENT > 0.25
ENTER BIAS WINDING VARIABLES					
VB	11.65		11.65	Volts	Bias Winding Voltage
VDB			0.70	Volts	Bias Winding Diode Forward Voltage Drop
NB			11		Bias Winding Number of Turns
VZOV			17.65	Volts	Over Voltage Protection zener diode voltage.
UVLO VARIABLES					
V_UV_TARGET			88.34	Volts	Target DC under-voltage threshold, above which the power supply will start
V_UV_ACTUAL			84.70	Volts	Typical DC start-up voltage based on standard value of RUV_ACTUAL
RUV_IDEAL			3.45	Mohms	Calculated value for UV Lockout resistor
RUV_ACTUAL			3.30	Mohms	Closest standard value of resistor to RUV_IDEAL
ENTER TRANSFORMER CORE/CONSTRUCTION VARIABLES					
Core Type	EE16		EE16		Enter Transformer Core
Core		EE16		P/N:	PC40EE16-Z
Custom core				P/N:	EE16_BOBBIN
AE			0.19	cm ²	Core Effective Cross Sectional Area
LE			3.50	cm	Core Effective Path Length
AL			1140	nH/T ²	Ungapped Core Effective Inductance
BW			8.6	mm	Bobbin Physical Winding Width
M			0.00	mm	Safety Margin Width (Half the Primary to



					Secondary Creepage Distance)
L	3		3		Number of Primary Layers
NS	12		12		Number of Secondary Turns
DC INPUT VOLTAGE PARAMETERS					
VMIN			80.3	Volts	Minimum DC Input Voltage
VMAX			374.8	Volts	Maximum DC Input Voltage
CURRENT WAVEFORM SHAPE PARAMETERS					
DMAX			0.58		Duty Ratio at full load, minimum primary inductance and minimum input voltage
Iavg			0.20	Amps	Average Primary Current
IP			0.51	Amps	Minimum Peak Primary Current
IR			0.39	Amps	Primary Ripple Current
IRMS			0.29	Amps	Primary RMS Current
TRANSFORMER PRIMARY DESIGN PARAMETERS					
LP			861	uHenries	Typical Primary Inductance. +/- 10% to ensure a minimum primary inductance of 774 uH
LP_TOLERANCE	10		10	%	Primary inductance tolerance
NP			90		Primary Winding Number of Turns
ALG			105	nH/T ²	Gapped Core Effective Inductance
BM			2918	Gauss	Maximum Operating Flux Density, BM<3100 is recommended
BAC			1099	Gauss	AC Flux Density for Core Loss Curves (0.5 X Peak to Peak)
ur			1654		Relative Permeability of Ungapped Core
LG			0.21	mm	Gap Length (Lg > 0.1 mm)
BWE			25.8	mm	Effective Bobbin Width
OD			0.286	mm	Maximum Primary Wire Diameter including insulation
INS			0.05	mm	Estimated Total Insulation Thickness (= 2 * film thickness)
DIA			0.23	mm	Bare conductor diameter
AWG			31	AWG	Primary Wire Gauge (Rounded to next smaller standard AWG value)
CM			81	Cmils	Bare conductor effective area in circular mils
CMA			274	Cmils/Amp	Primary Winding Current Capacity (200 < CMA < 500)
TRANSFORMER SECONDARY DESIGN PARAMETERS					
Lumped parameters					
ISP			3.85	Amps	Peak Secondary Current
ISRMS			1.90	Amps	Secondary RMS Current
IRIPPLE			1.62	Amps	Output Capacitor RMS Ripple Current
CMS			381	Cmils	Secondary Bare Conductor minimum circular mils
AWGS			24	AWG	Secondary Wire Gauge (Rounded up to next larger standard AWG value)
VOLTAGE STRESS PARAMETERS					
VDRAIN			596	Volts	Maximum Drain Voltage Estimate (Assumes 20% zener clamp tolerance and an additional 10% temperature tolerance)
PIVS			62	Volts	Output Rectifier Maximum Peak Inverse Voltage
TRANSFORMER SECONDARY DESIGN PARAMETERS (MULTIPLE OUTPUTS)					
1st output					
VO1	12.00		12.00	Volts	Main Output Voltage (if unused, defaults to single output design)
IO1	1.00		1.00	Amps	Output DC Current
PO1			12	Watts	Output Power
VD1			0.70	Volts	Output Diode Forward Voltage Drop
NS1			12.00		Output Winding Number of Turns
ISRMS1			1.903	Amps	Output Winding RMS Current
IRIPPLE1			1.62	Amps	Output Capacitor RMS Ripple Current
PIVS1			62	Volts	Output Rectifier Maximum Peak Inverse Voltage
Recommended Diodes			1N5820, SB320		Recommended Diodes for this output



CMS1			381	Cmils	Output Winding Bare Conductor minimum circular mils
AWGS1			24	AWG	Wire Gauge (Rounded up to next larger standard AWG value)
DIAS1			0.51	mm	Minimum Bare Conductor Diameter
ODS1			0.72	mm	Maximum Outside Diameter for Triple Insulated Wire



10 Performance Data

10.1 Efficiency

10.1.1 Active Mode Measurement Data

Measured Performance			Standards			
		V_{IN} (VAC)		DOE6	EC CoC (v5)	
		115	230		2014 Tier 1	2016 Tier 2
		Efficiency (%)				
Load (%)	10	77.88	75.27		70	73
	25	83.68	82.67			
	50	84.87	84.46			
	75	85.14	84.77			
	100	84.61	85.02			
	Ave	84.57	84.23	83	80	83
No-Load Input Power (mW)		36 (27)	60 (28)	100	150	75
		Compliant		Y	Y	Y

† Numbers in parenthesis represent no-load input power without UV sensing.

10.1.2 Full Load Efficiency vs. Line

Test Condition: Soak for 15 minutes for each line.

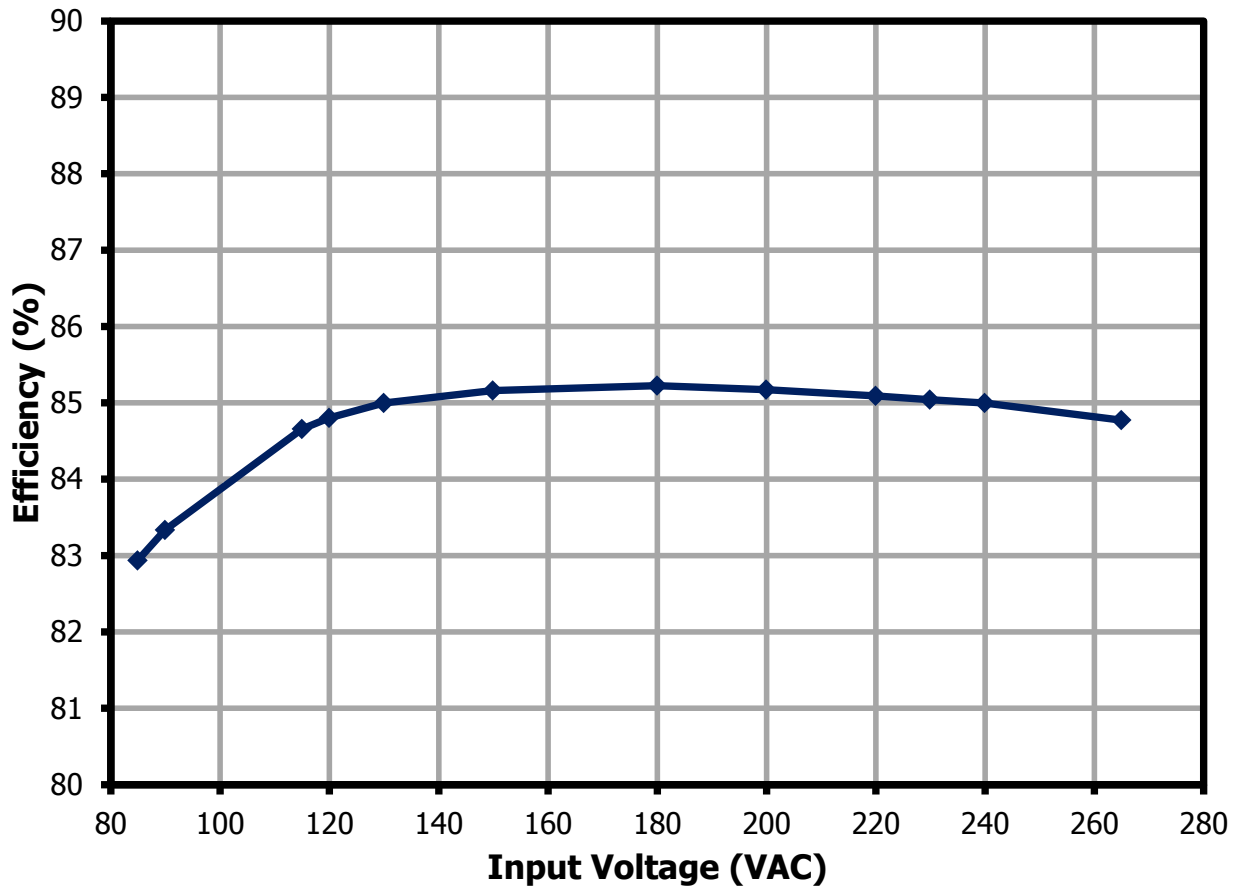

Figure 8 – Full Load Efficiency vs. Line.



10.1.3 Efficiency vs. Load

Test Condition: Soak for 15 minutes each line, and 5 minutes for each load.

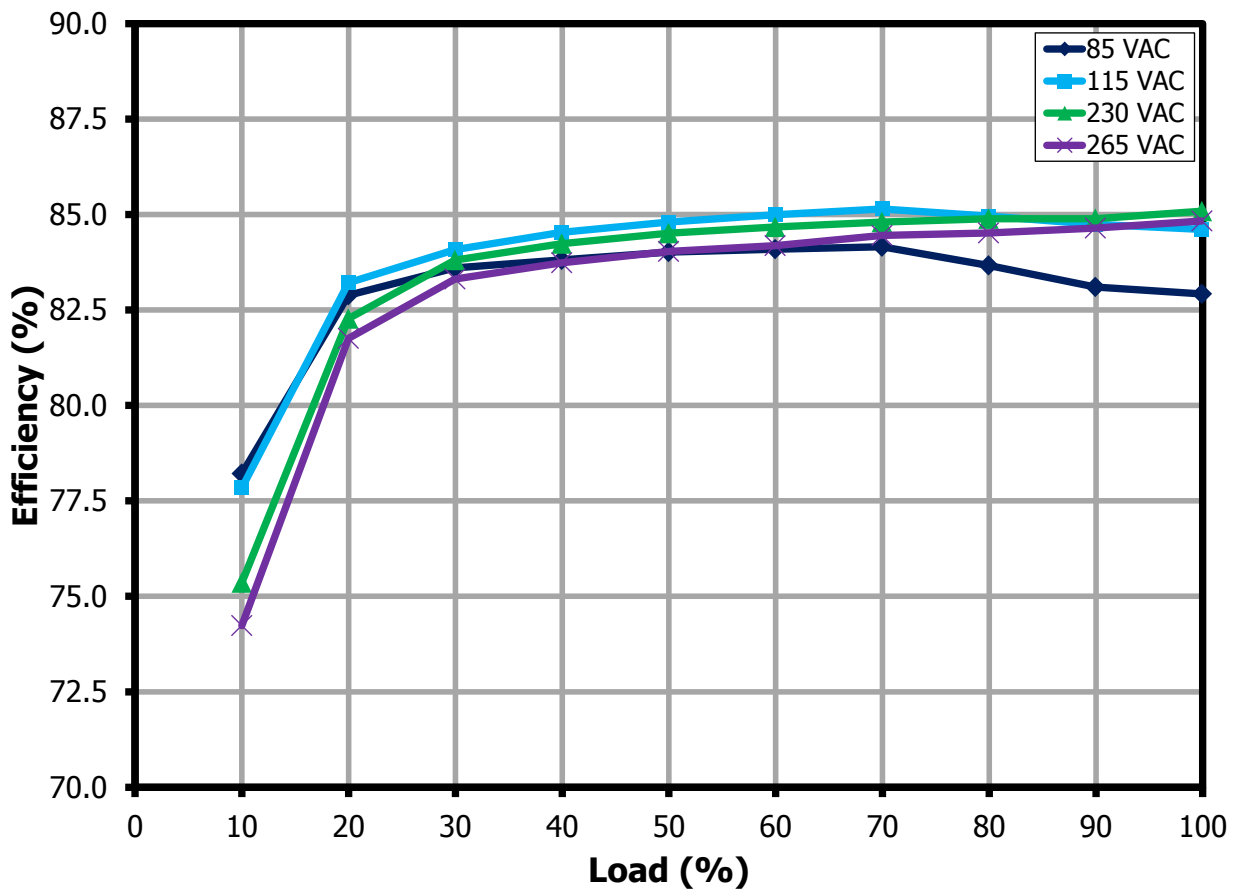

Figure 9 – Efficiency vs. Percentage Load.

10.2 Available Standby Output Power

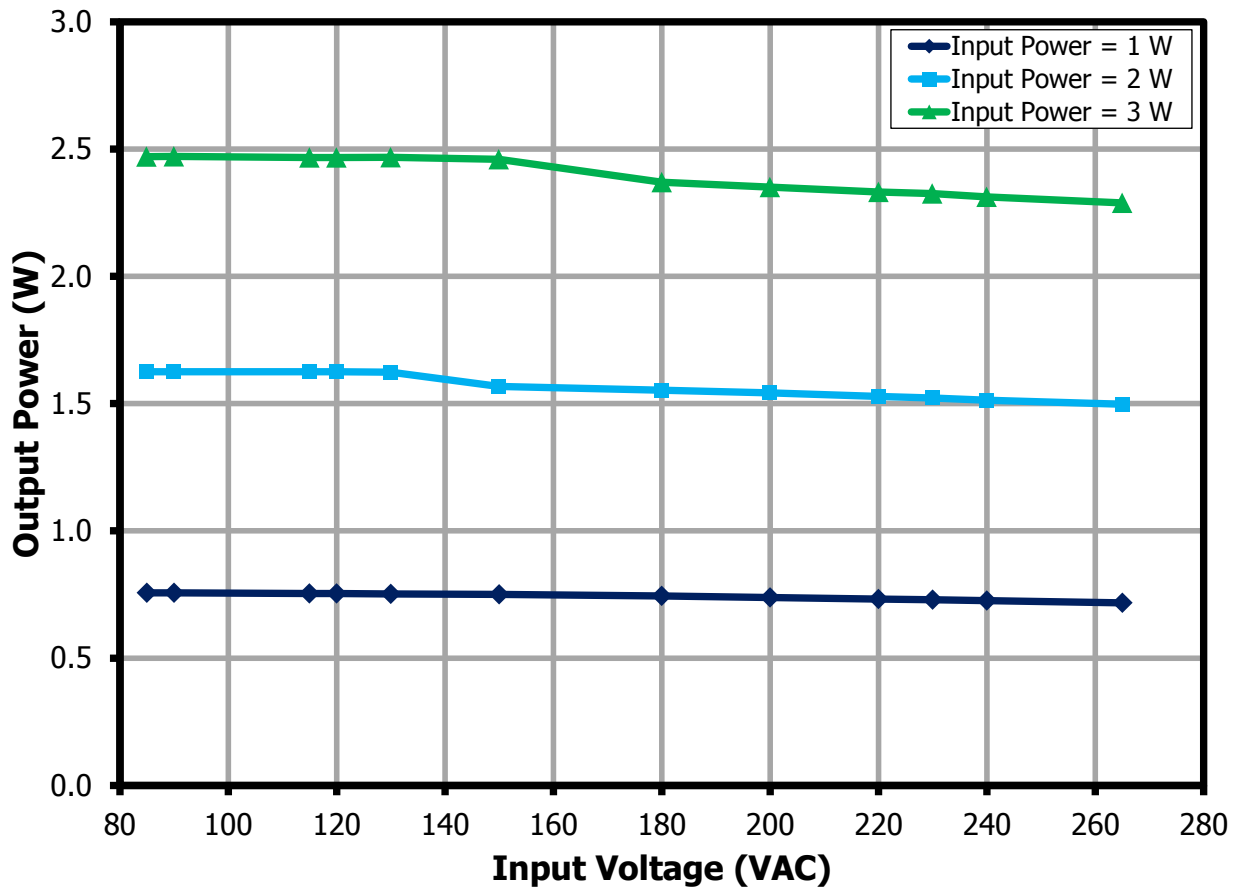

Figure 10 – Available Standby Output Power for 1 W, 2 W and 3 W Input Power.



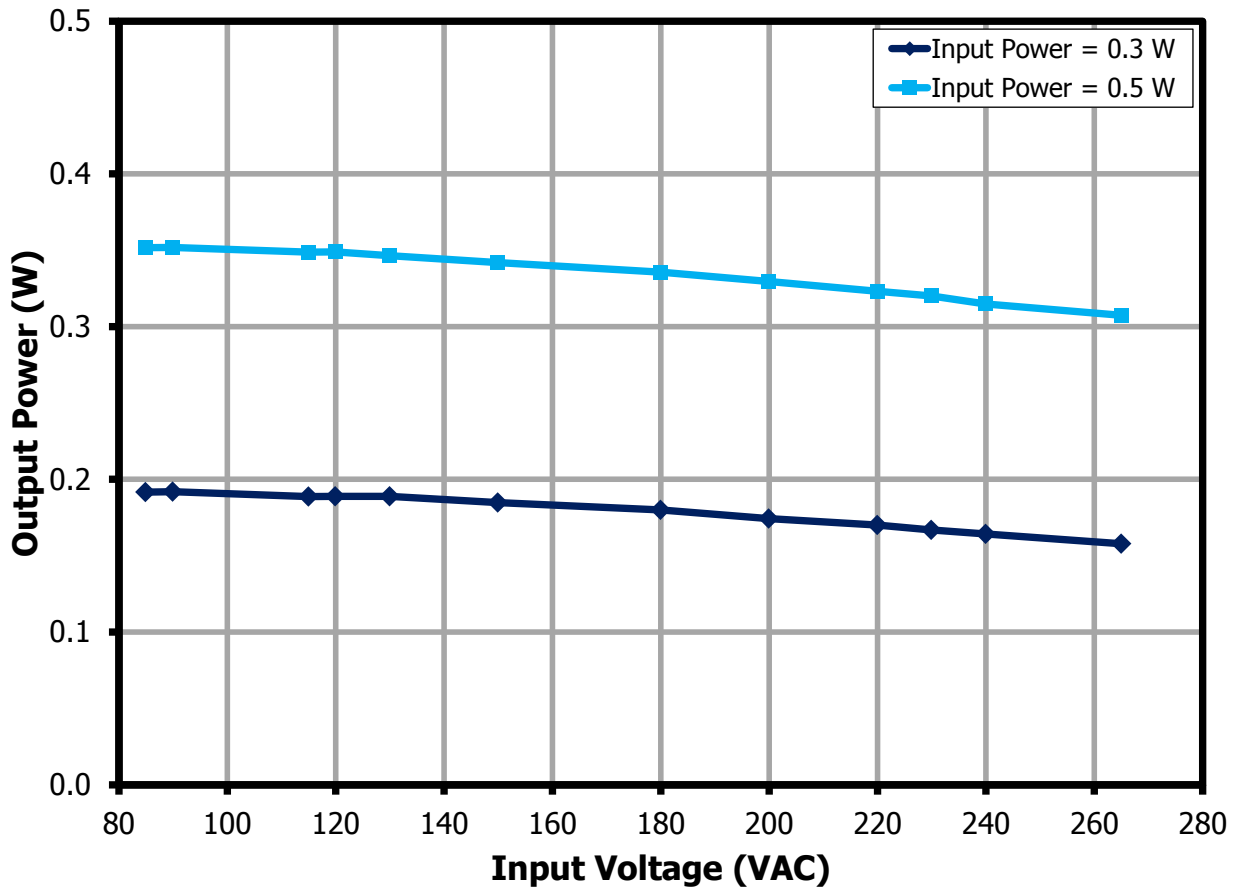

Figure 11 – Available Standby Output Power for 0.3 W and 0.5 W Input Power.

10.3 *No-Load Input Power*

Test Condition: Soak for 15 minutes each line and 1 minute integration time.

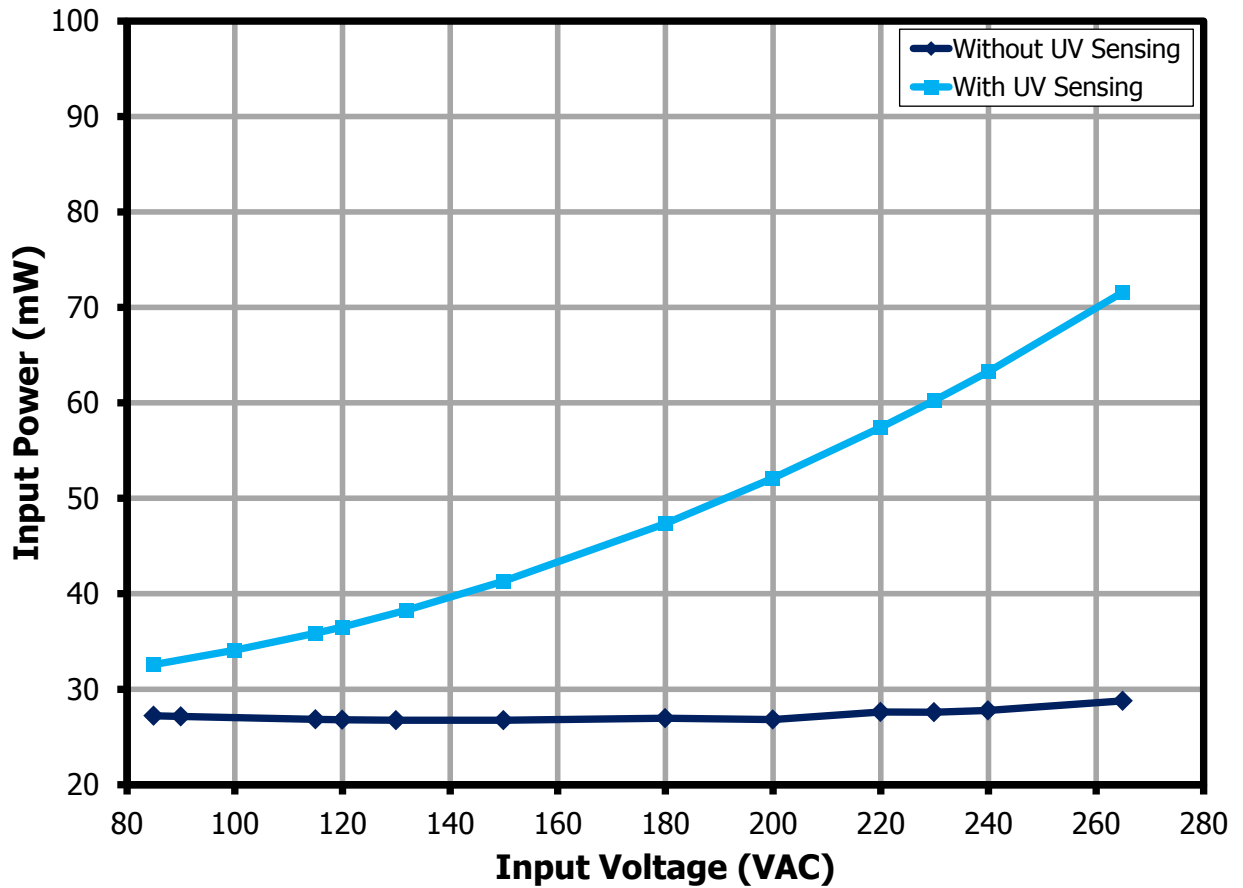

Figure 12 – No-Load Input Power vs. Line at Room Temperature.



10.4 *Line Regulation*

Test Condition: Soak for 15 minutes for each line.

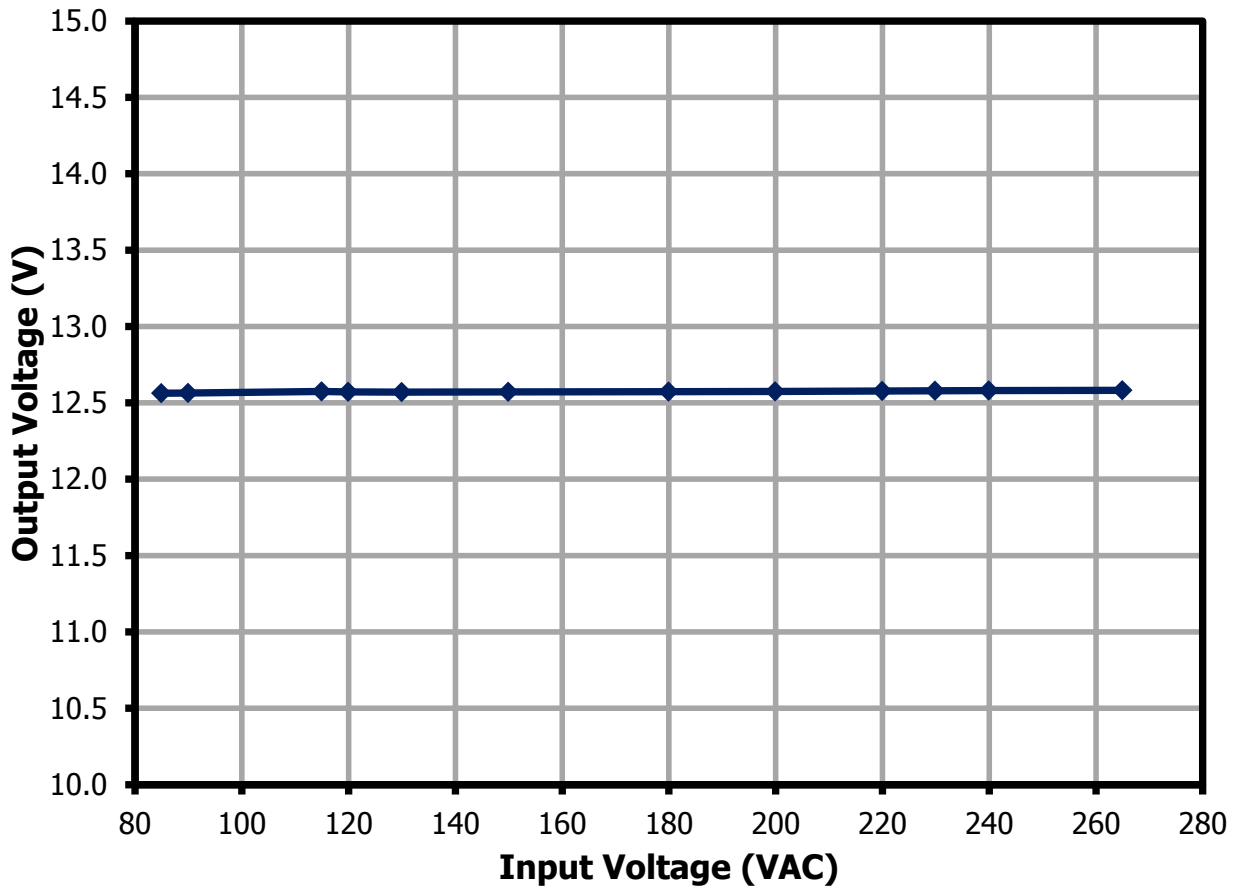

Figure 13 – Output Voltage vs. Line Voltage.

10.5 Load Regulation

Test Condition: Soak for 15 minutes each line, and 5 minutes for each load.

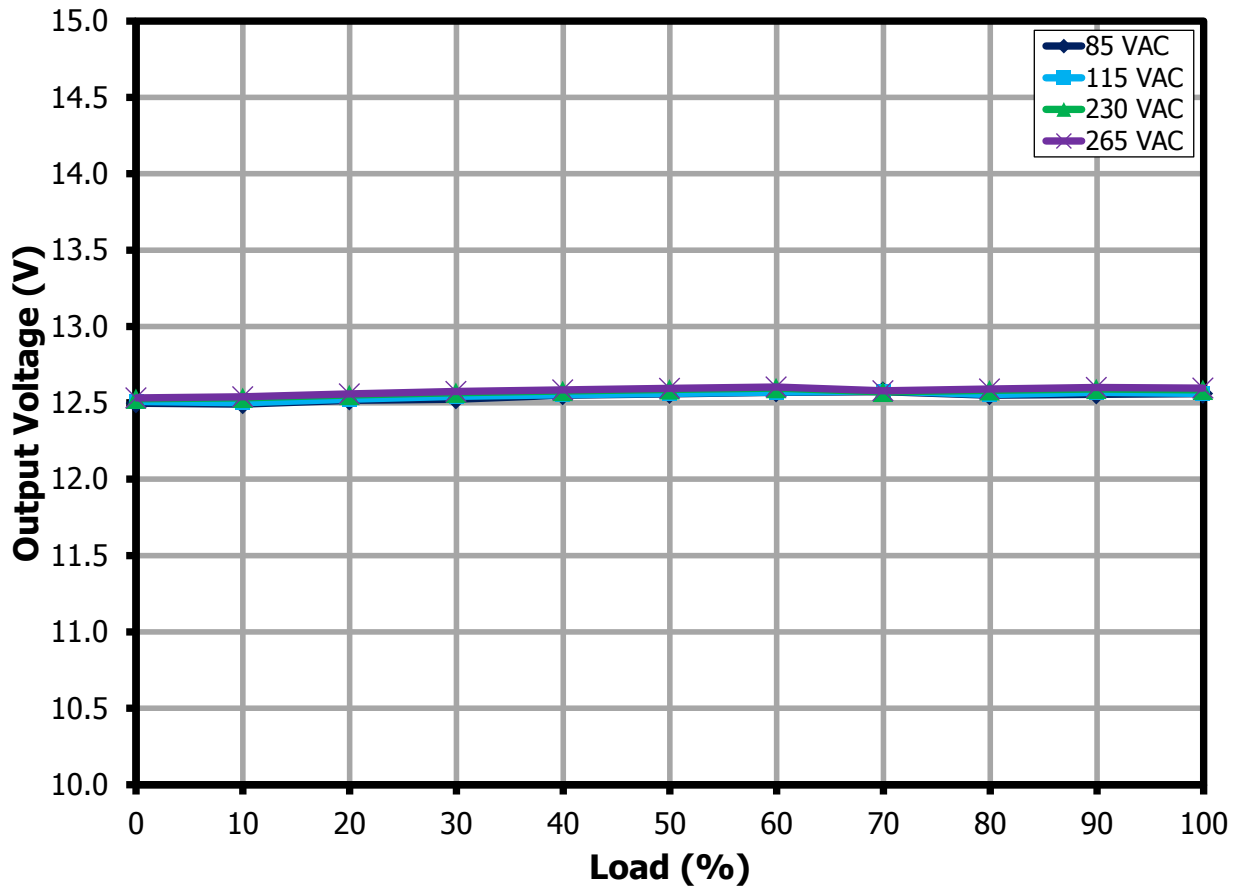

Figure 14 – Output Voltage vs. Percent Load.



11 Waveforms

11.1 Load Transient Response

Test Condition: Dynamic load frequency = 1 kHz, Duty cycle = 50 %

11.1.1 0% - 100% Load Change

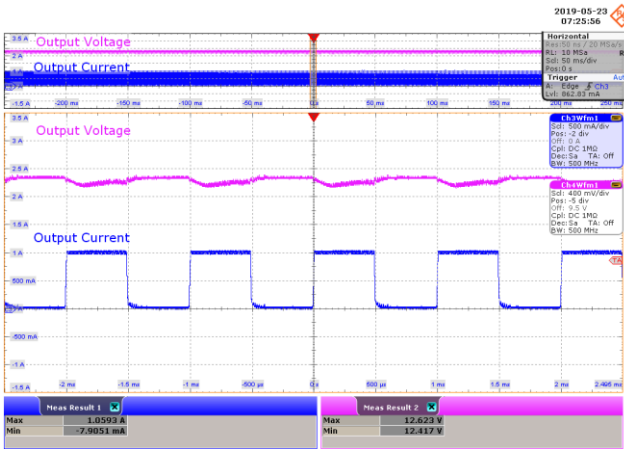

Figure 15 – 85 VAC 60 Hz.

CH3: I_{OUT} , 500 mA / div., 50 ms / div.
 CH4: V_{OUT} , 400 mV / div., 50 ms / div.
 Zoom = 500 μ s / div.
 V_{MAX} : 12.623 V, V_{MIN} : 12.417 V.

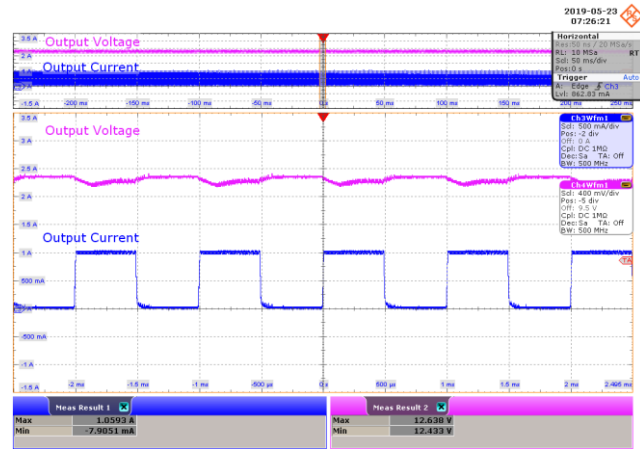

Figure 16 – 115 VAC 60 Hz.

CH3: I_{OUT} , 500 mA / div., 50 ms / div.
 CH4: V_{OUT} , 400 mV / div., 50 ms / div.
 Zoom = 500 μ s / div.
 V_{MAX} : 12.638 V, V_{MIN} : 12.433 V.

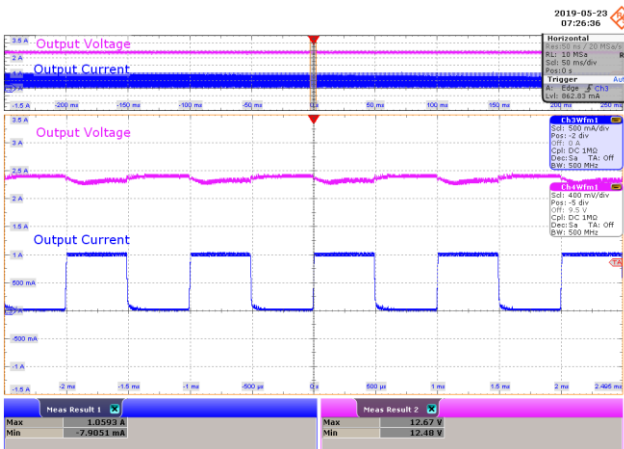

Figure 17 – 230 VAC 50 Hz.

CH3: I_{OUT} , 500 mA / div., 50 ms / div.
 CH4: V_{OUT} , 400 mV / div., 50 ms / div.
 Zoom = 500 μ s / div.
 V_{MAX} : 12.67 V, V_{MIN} : 12.48 V.

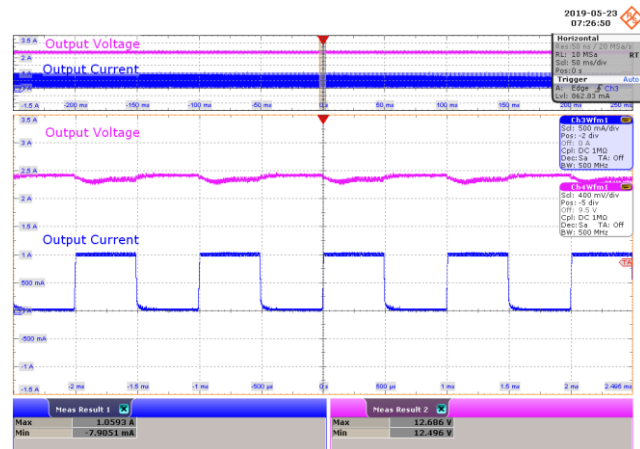

Figure 18 – 265 VAC 50 Hz.

CH3: I_{OUT} , 500 mA / div., 50 ms / div.
 CH4: V_{OUT} , 400 mV / div., 50 ms / div.
 Zoom = 500 μ s / div.
 V_{MAX} : 12.686 V, V_{MIN} : 12.496 V.

11.1.2 50% - 100% Load Change

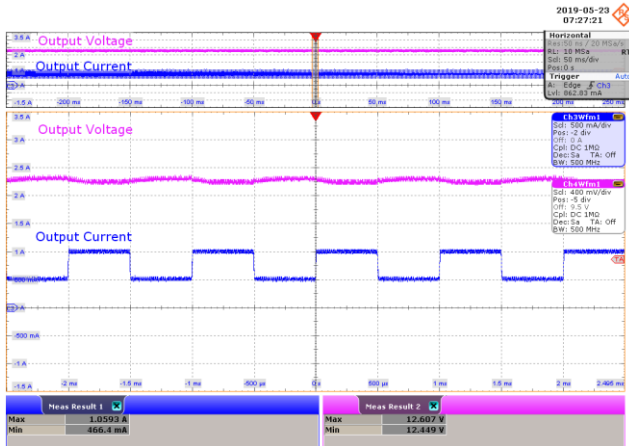

Figure 19 – 85 VAC 60 Hz.
 CH3: I_{OUT} , 500 mA / div., 50 ms / div.
 CH4: V_{OUT} , 400 mV / div., 50 ms / div.
 Zoom = 500 μ s / div.
 V_{MAX} : 12.607 V, V_{MIN} : 12.449 V.

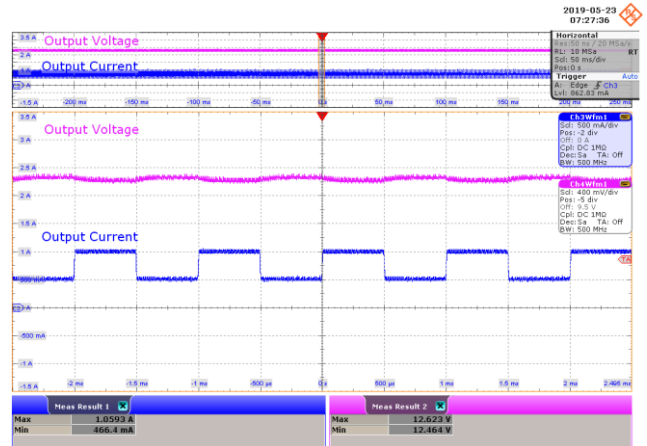

Figure 20 – 115 VAC 60 Hz.
 CH3: I_{OUT} , 500 mA / div., 50 ms / div.
 CH4: V_{OUT} , 400 mV / div., 50 ms / div.
 Zoom = 500 μ s / div.
 V_{MAX} : 12.623 V, V_{MIN} : 12.464 V.

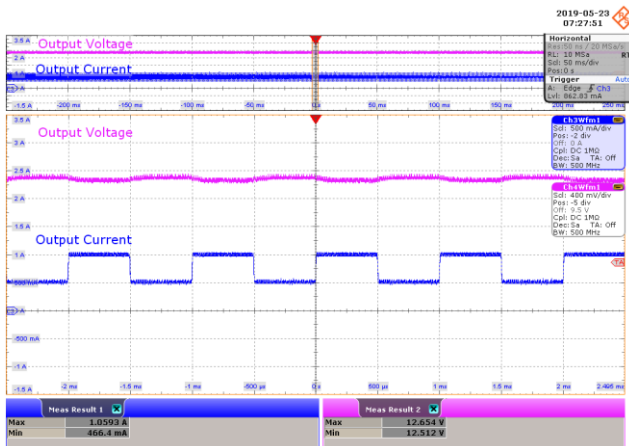

Figure 21 – 230 VAC 50 Hz.
 CH3: I_{OUT} , 500 mA / div., 50 ms / div.
 CH4: V_{OUT} , 400 mV / div., 50 ms / div.
 Zoom = 500 μ s / div.
 V_{MAX} : 12.654 V, V_{MIN} : 12.512 V.

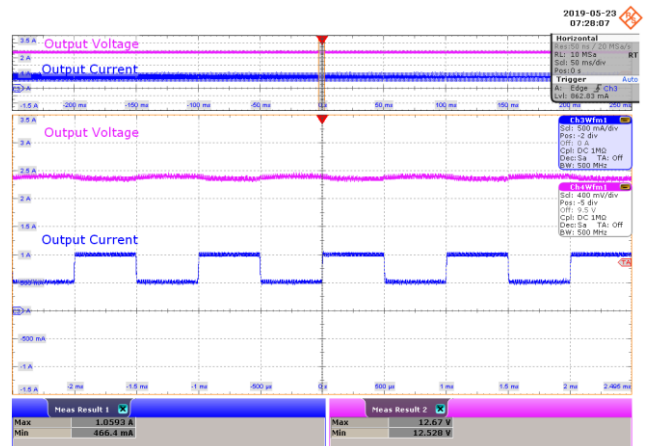

Figure 22 – 265 VAC 50 Hz.
 CH3: I_{OUT} , 500 mA / div., 50 ms / div.
 CH4: V_{OUT} , 400 mV / div., 50 ms / div.
 Zoom = 500 μ s / div.
 V_{MAX} : 12.67 V, V_{MIN} : 12.528 V.



11.2 Output Voltage at Start-up

11.2.1 CC Mode

11.2.1.1 100% Load

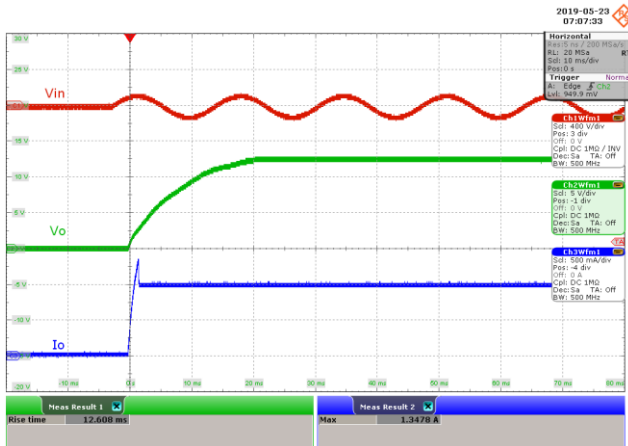

Figure 23 – 85 VAC 60 Hz.

CH1: V_{IN} , 400 V / div., 10 ms / div.
 CH2: V_{OUT} , 5 V / div., 10 ms / div.
 CH3: I_{OUT} , 500 mA / div., 10 ms / div.
 Rise Time = 12.608 ms.

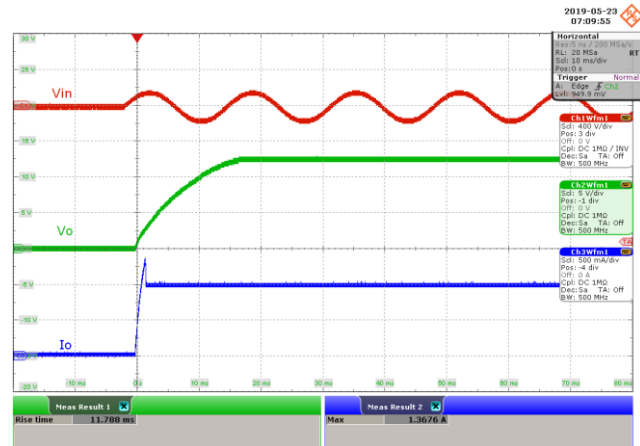

Figure 24 – 115 VAC 60 Hz.

CH1: V_{IN} , 400 V / div., 10 ms / div.
 CH2: V_{OUT} , 5 V / div., 10 ms / div.
 CH3: I_{OUT} , 500 mA / div., 10 ms / div.
 Rise Time = 11.788 ms.

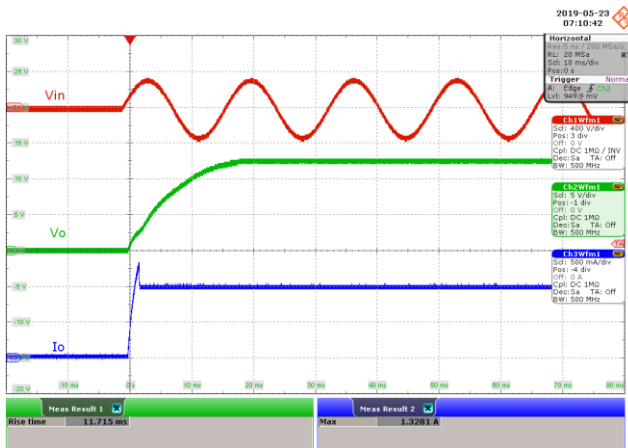

Figure 25 – 230 VAC 50 Hz.

CH1: V_{IN} , 400 V / div., 10 ms / div.
 CH2: V_{OUT} , 5 V / div., 10 ms / div.
 CH3: I_{OUT} , 500 mA / div., 10 ms / div.
 Rise Time = 11.715 ms.

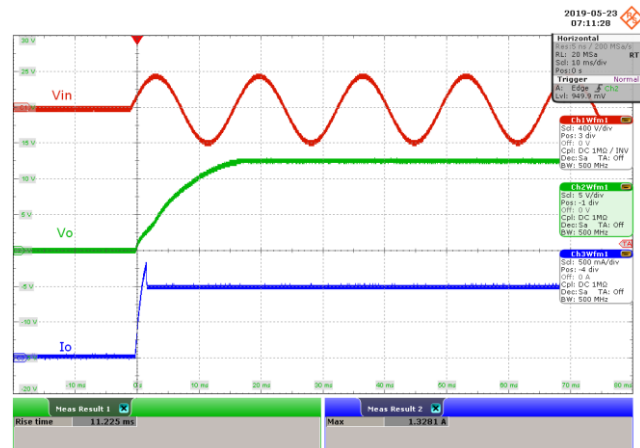

Figure 26 – 265 VAC 50 Hz.

CH1: V_{IN} , 400 V / div., 10 ms / div.
 CH2: V_{OUT} , 5 V / div., 10 ms / div.
 CH3: I_{OUT} , 500 mA / div., 10 ms / div.
 Rise Time = 11.225 ms.

11.2.1.2 0% Load

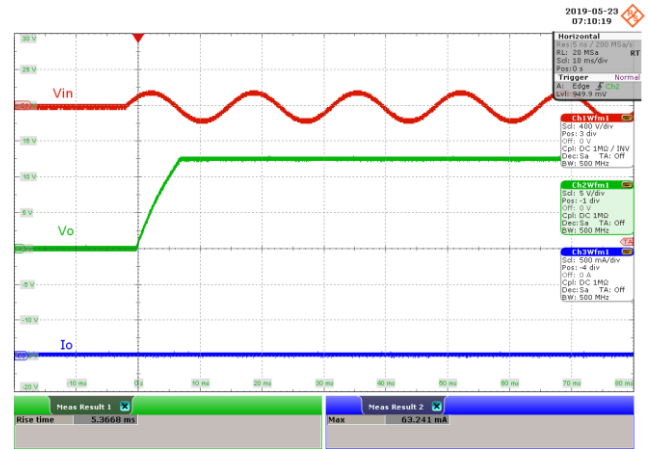

Figure 27 – 85 VAC 60 Hz.

CH1: V_{IN} , 400 V / div., 10 ms / div.
 CH2: V_{OUT} , 5 V / div., 10 ms / div.
 CH3: I_{OUT} , 500 mA / div., 10 ms / div.
 Rise Time = 5.6977 ms.

Figure 28 – 115 VAC 60 Hz.

CH1: V_{IN} , 400 V / div., 10 ms / div.
 CH2: V_{OUT} , 5 V / div., 10 ms / div.
 CH3: I_{OUT} , 500 mA / div., 10 ms / div.
 Rise Time = 5.3668 ms.

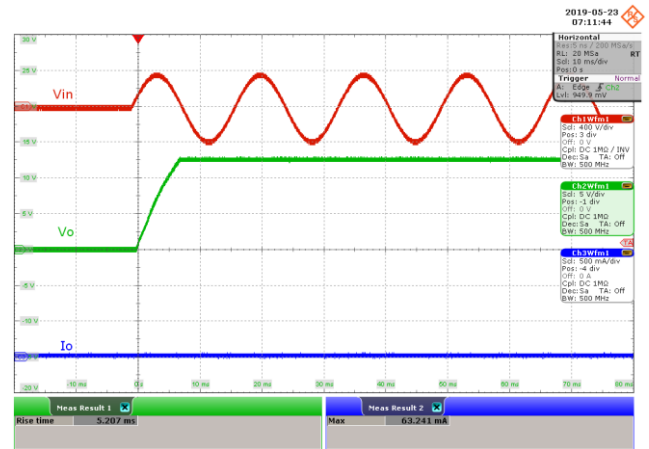
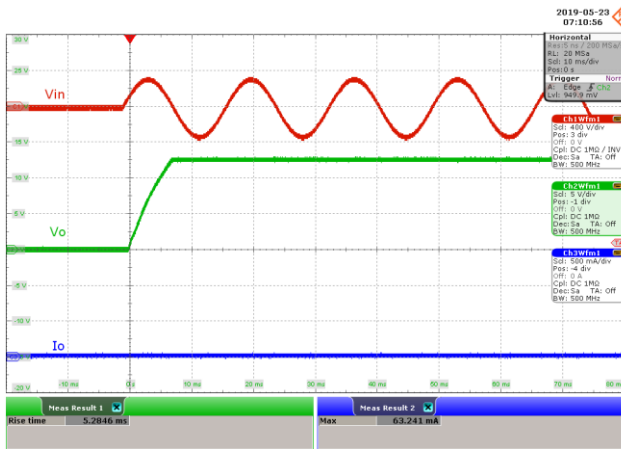

Figure 29 – 230 VAC 50 Hz.

CH1: V_{IN} , 400 V / div., 10 ms / div.
 CH2: V_{OUT} , 5 V / div., 10 ms / div.
 CH3: I_{OUT} , 500 mA / div., 10 ms / div.
 Rise Time = 5.2846 ms.

Figure 30 – 265 VAC 50 Hz.

CH1: V_{IN} , 400 V / div., 10 ms / div.
 CH2: V_{OUT} , 5 V / div., 10 ms / div.
 CH3: I_{OUT} , 500 mA / div., 10 ms / div.
 Rise Time = 5.207 ms.



11.2.2 CR Mode

11.2.2.1 100% Load

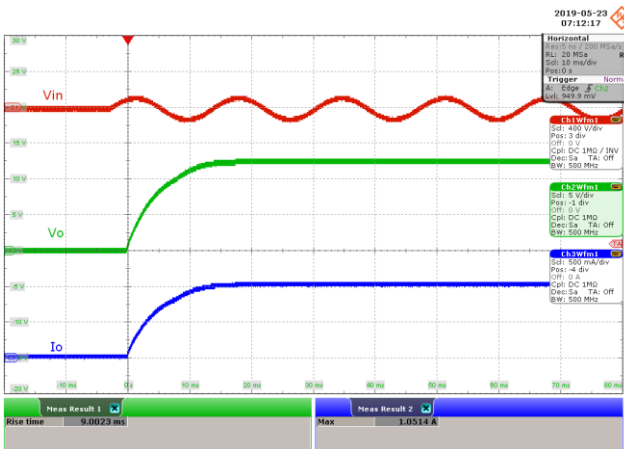

Figure 31 – 85 VAC 60 Hz.

CH1: V_{IN} , 400 V / div., 10 ms / div.
 CH2: V_{OUT} , 5 V / div., 10 ms / div.
 CH3: I_{OUT} , 500 mA / div., 10 ms / div.
 Rise Time = 9.0023 ms.

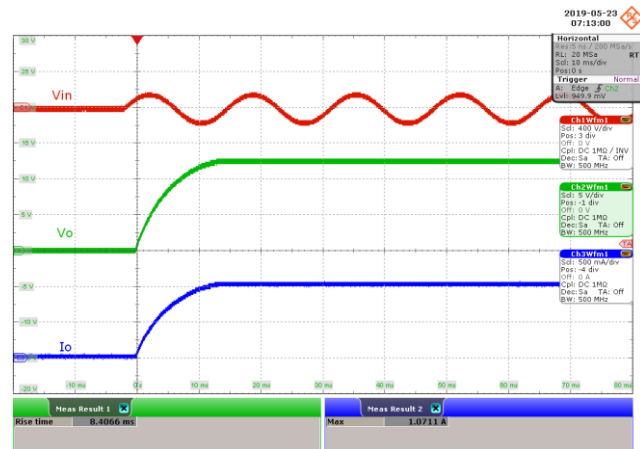

Figure 32 – 115 VAC 60 Hz.

CH1: V_{IN} , 400 V / div., 10 ms / div.
 CH2: V_{OUT} , 5 V / div., 10 ms / div.
 CH3: I_{OUT} , 500 mA / div., 10 ms / div.
 Rise Time = 8.4066 ms.

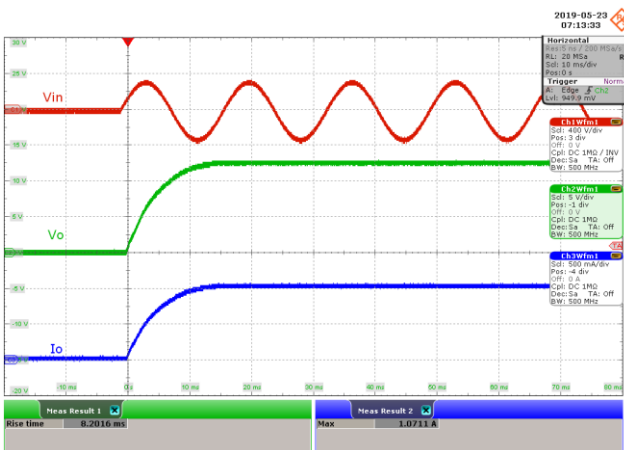

Figure 33 – 230 VAC 50 Hz.

CH1: V_{IN} , 400 V / div., 10 ms / div.
 CH2: V_{OUT} , 5 V / div., 10 ms / div.
 CH3: I_{OUT} , 500 mA / div., 10 ms / div.
 Rise Time = 8.2016 ms.

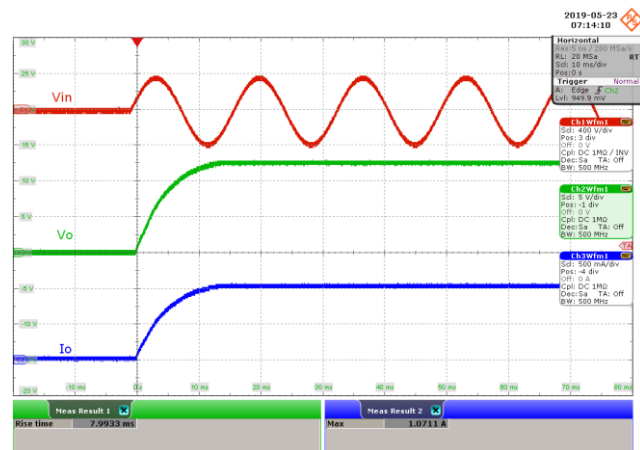

Figure 34 – 265 VAC 50 Hz.

CH1: V_{IN} , 400 V / div., 10 ms / div.
 CH2: V_{OUT} , 5 V / div., 10 ms / div.
 CH3: I_{OUT} , 500 mA / div., 10 ms / div.
 Rise Time = 7.9933 ms.

11.2.2.2 0% Load

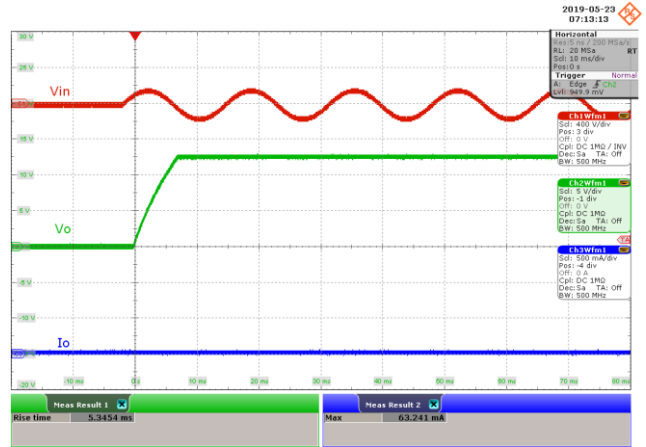
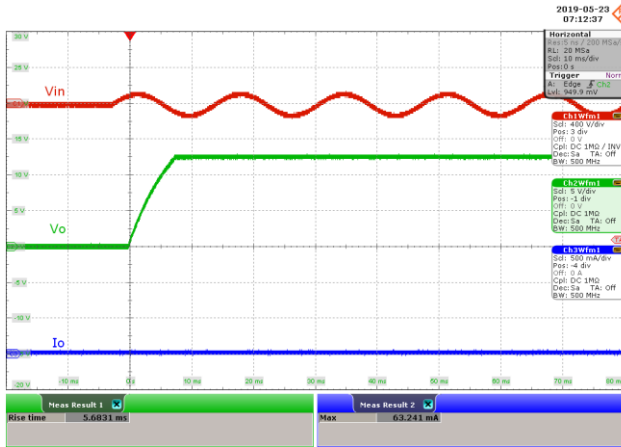

Figure 35 – 85 VAC 60 Hz.

CH1: V_{IN} , 400 V / div., 10 ms / div.
 CH2: V_{OUT} , 5 V / div., 10 ms / div.
 CH3: I_{OUT} , 500 mA / div., 10 ms / div.
 Rise Time = 5.6831 ms.

Figure 36 – 115 VAC 60 Hz.

CH1: V_{IN} , 400 V / div., 10 ms / div.
 CH2: V_{OUT} , 5 V / div., 10 ms / div.
 CH3: I_{OUT} , 500 mA / div., 10 ms / div.
 Rise Time = 5.3454 ms.

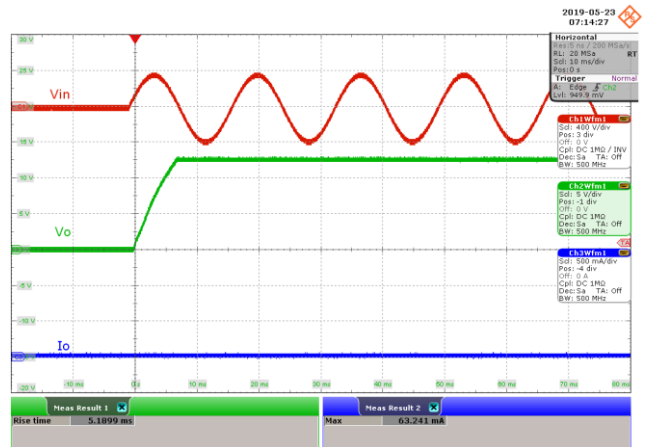
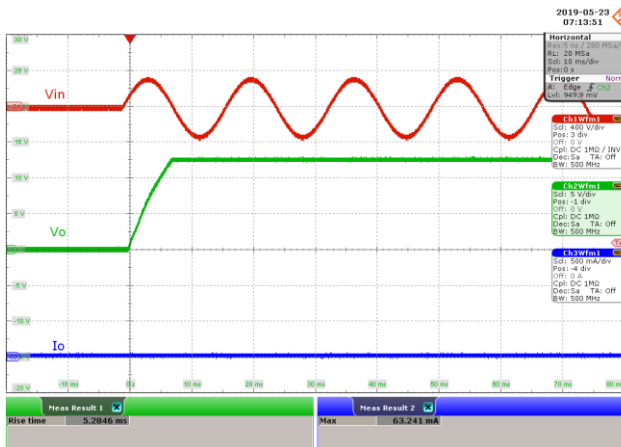

Figure 37 – 230 VAC 50 Hz.

CH1: V_{IN} , 400 V / div., 10 ms / div.
 CH2: V_{OUT} , 5 V / div., 10 ms / div.
 CH3: I_{OUT} , 500 mA / div., 10 ms / div.
 Rise Time = 5.2846 ms.

Figure 38 – 265 VAC 50 Hz.

CH1: V_{IN} , 400 V / div., 10 ms / div.
 CH2: V_{OUT} , 5 V / div., 10 ms / div.
 CH3: I_{OUT} , 500 mA / div., 10 ms / div.
 Rise Time = 5.1899 ms.



11.3 Switching Waveforms

11.3.1 Primary MOSFET Drain-Source Voltage and Current at Normal Operation

11.3.1.1 100% Load

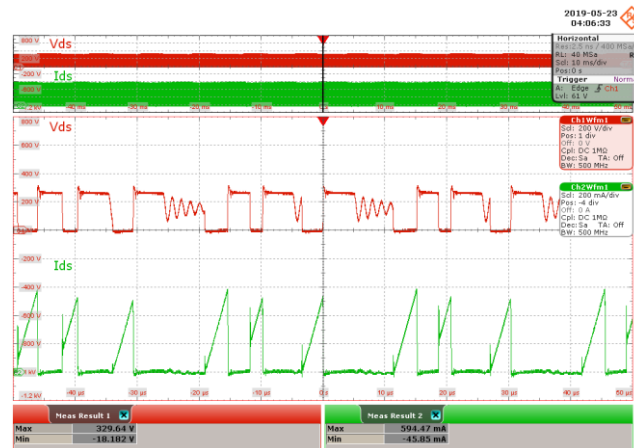
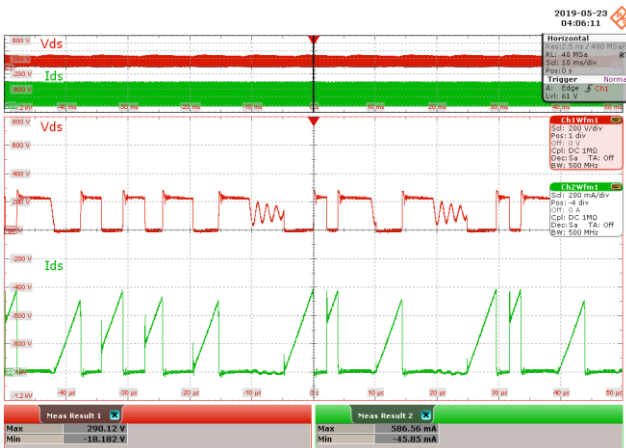

Figure 39 – 85 VAC 60 Hz.

CH1: V_{DS} , 200 V / div., 10 ms / div.
 CH2: I_{DS} , 200 mA / div., 10 ms / div.
 Zoom: 10 μ s / div.
 $V_{DS(MAX)} = 290.12$ V, $I_{DS(MAX)} = 586.56$ mA.

Figure 40 – 115 VAC 60 Hz.

CH1: V_{DS} , 200 V / div., 10 ms / div.
 CH2: I_{DS} , 200 mA / div., 10 ms / div.
 Zoom: 10 μ s / div.
 $V_{DS(MAX)} = 329.64$ V, $I_{DS(MAX)} = 594.47$ mA.



Figure 41 – 230 VAC 50 Hz.

CH1: V_{DS} , 200 V / div., 10 ms / div.
 CH2: I_{DS} , 200 mA / div., 10 ms / div.
 Zoom: 10 μ s / div.
 $V_{DS(MAX)} = 487.75$ V, $I_{DS(MAX)} = 547.04$ mA.

Figure 42 – 265 VAC 50 Hz.

CH1: V_{DS} , 200 V / div., 10 ms / div.
 CH2: I_{DS} , 200 mA / div., 10 ms / div.
 Zoom: 10 μ s / div.
 $V_{DS(MAX)} = 543.08$ V, $I_{DS(MAX)} = 539.13$ mA.

11.3.1.2 0% Load

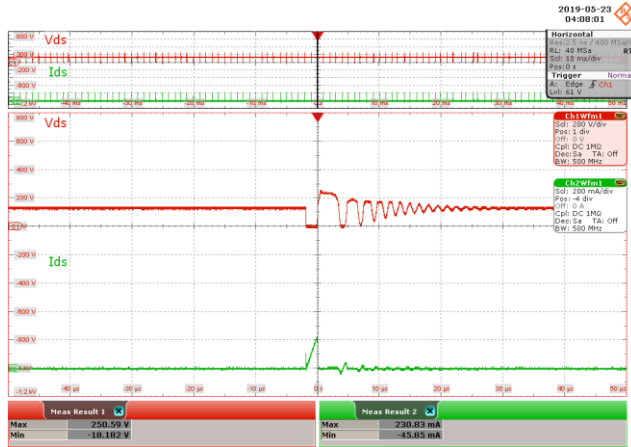

Figure 43 – 85 VAC 60 Hz.
 CH1: V_{DS} , 200 V / div., 10 ms / div.
 CH2: I_{DS} , 200 mA / div., 10 ms / div.
 Zoom: 10 μ s / div.
 $V_{DS(MAX)} = 250.59$ V, $I_{DS(MAX)} = 230.83$ mA.

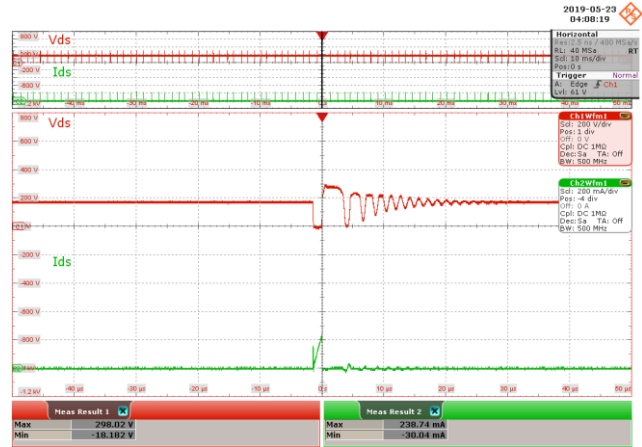

Figure 44 – 115 VAC 60 Hz.
 CH1: V_{DS} , 200 V / div., 10 ms / div.
 CH2: I_{DS} , 200 mA / div., 10 ms / div.
 Zoom: 10 μ s / div.
 $V_{DS(MAX)} = 298.02$ V, $I_{DS(MAX)} = 238.74$ mA.

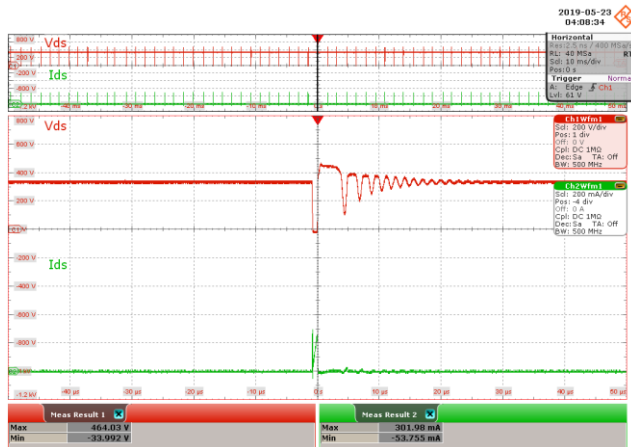

Figure 45 – 230 VAC 50 Hz.
 CH1: V_{DS} , 200 V / div., 10 ms / div.
 CH2: I_{DS} , 200 mA / div., 10 ms / div.
 Zoom: 10 μ s / div.
 $V_{DS(MAX)} = 464.03$ V, $I_{DS(MAX)} = 301.98$ mA.

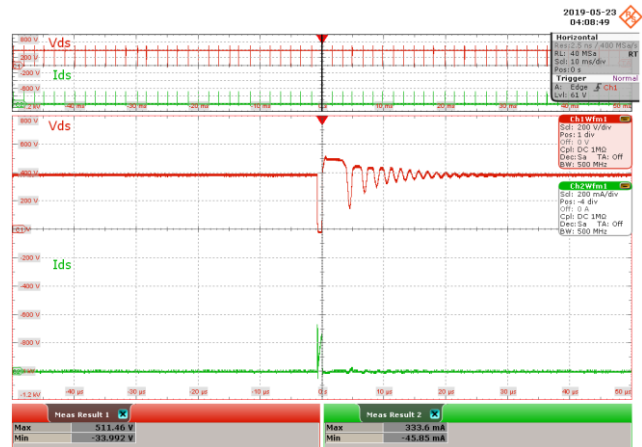

Figure 46 – 265 VAC 50 Hz.
 CH1: V_{DS} , 200 V / div., 10 ms / div.
 CH2: I_{DS} , 200 mA / div., 10 ms / div.
 Zoom: 10 μ s / div.
 $V_{DS(MAX)} = 511.46$ V, $I_{DS(MAX)} = 333.6$ mA.



11.3.2 Primary MOSFET Drain-Source Voltage and Current at Start-up Operation

11.3.2.1 100% Load

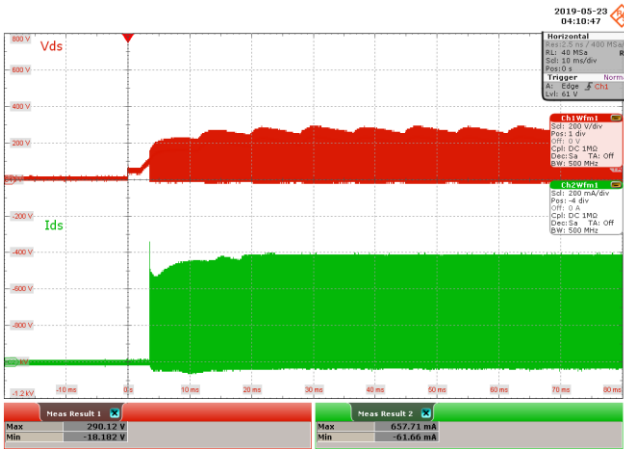

Figure 47 – 85 VAC 60 Hz.
 CH1: V_{DS} , 200 V / div., 10 ms / div.
 CH2: I_{DS} , 200 mA / div., 10 ms / div.
 $V_{DS(MAX)} = 290.12\text{ V}$, $I_{DS(MAX)} = 657.71\text{ mA}$.



Figure 48 – 115 VAC 60 Hz.
 CH1: V_{DS} , 200 V / div., 10 ms / div.
 CH2: I_{DS} , 200 mA / div., 10 ms / div.
 $V_{DS(MAX)} = 329.64\text{ V}$, $I_{DS(MAX)} = 673.52\text{ mA}$.



Figure 49 – 230 VAC 50 Hz.
 CH1: V_{DS} , 200 V / div., 10 ms / div.
 CH2: I_{DS} , 200 mA / div., 10 ms / div.
 $V_{DS(MAX)} = 495.65\text{ V}$, $I_{DS(MAX)} = 744.66\text{ mA}$.

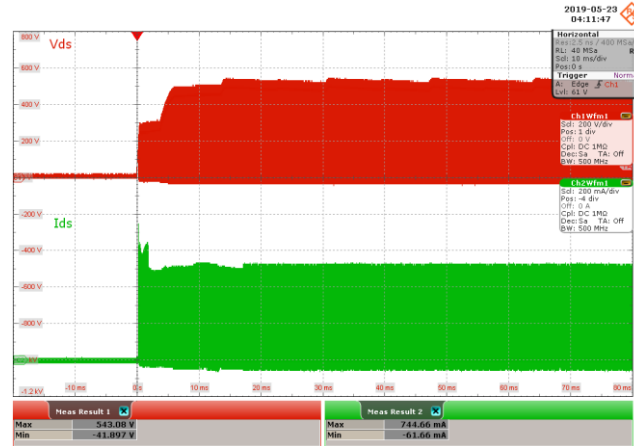

Figure 50 – 265 VAC 50 Hz.
 CH1: V_{DS} , 200 V / div., 10 ms / div.
 CH2: I_{DS} , 200 mA / div., 10 ms / div.
 $V_{DS(MAX)} = 543.08\text{ V}$, $I_{DS(MAX)} = 744.66\text{ mA}$.

11.3.2.2 0% Load



Figure 51 – 85 VAC 60 Hz.
 CH1: V_{DS} , 200 V / div., 10 ms / div.
 CH2: I_{DS} , 200 mA / div., 10 ms / div.
 $V_{DS(MAX)} = 274.31$ V, $I_{DS(MAX)} = 720.95$ mA.



Figure 52 – 115 VAC 60 Hz.
 CH1: V_{DS} , 200 V / div., 10 ms / div.
 CH2: I_{DS} , 200 mA / div., 10 ms / div.
 $V_{DS(MAX)} = 305.93$ V, $I_{DS(MAX)} = 728.85$ mA.

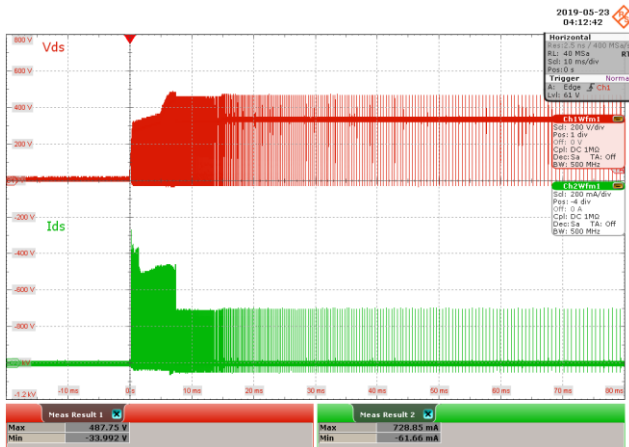

Figure 53 – 230 VAC 50 Hz.
 CH1: V_{DS} , 200 V / div., 10 ms / div.
 CH2: I_{DS} , 200 mA / div., 10 ms / div.
 $V_{DS(MAX)} = 487.75$ V, $I_{DS(MAX)} = 728.85$ mA.

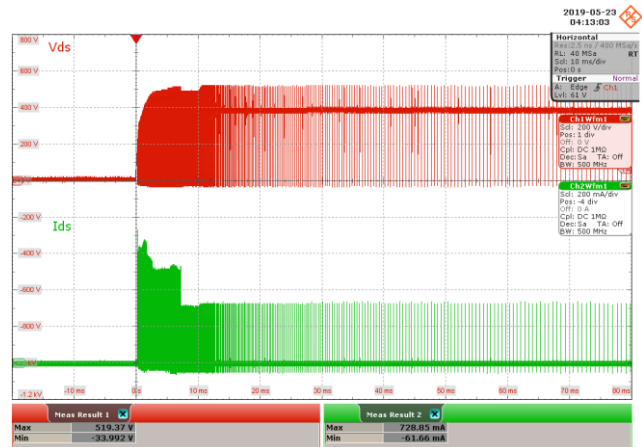

Figure 54 – 265 VAC 50 Hz.
 CH1: V_{DS} , 200 V / div., 10 ms / div.
 CH2: I_{DS} , 200 mA / div., 10 ms / div.
 $V_{DS,MAX} = 519.37$ V, $I_{DS(MAX)} = 728.85$ mA.



11.3.3 Output Diode Voltage and Current at Normal Operation

11.3.3.1 100% Load

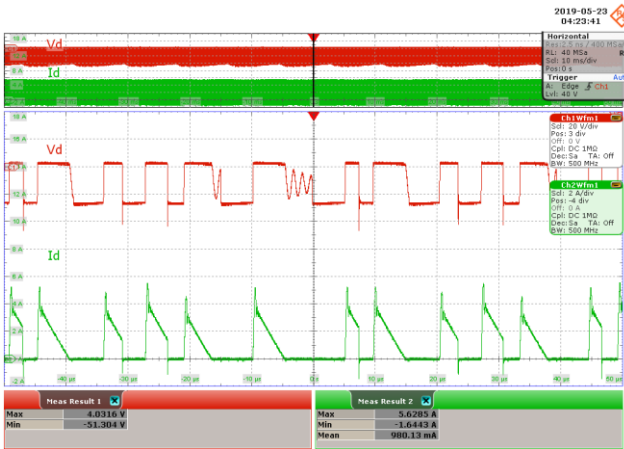

Figure 55 – 85 VAC 60 Hz.
 CH1: V_D , 20 V / div., 10 ms / div.
 CH2: I_D , 2 A / div., 10 ms / div.
 Zoom: 10 μ s / div.
 PIV = 51.304 V, $I_{D(MAX)} = 5.6285$ A.

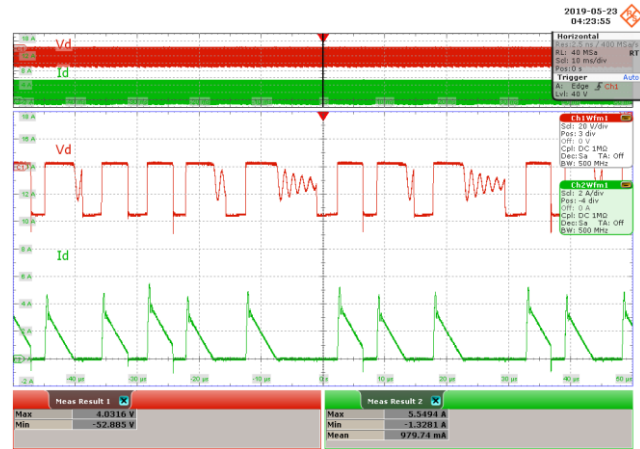

Figure 56 – 115 VAC 60 Hz.
 CH1: V_D , 20 V / div., 10 ms / div.
 CH2: I_D , 2 A / div., 10 ms / div.
 Zoom: 10 μ s / div.
 PIV = 52.885 V, $I_{D(MAX)} = 5.5494$ A.

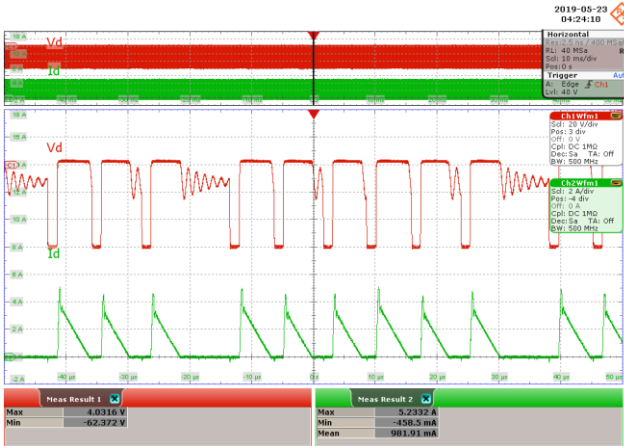

Figure 57 – 230 VAC 50 Hz.
 CH1: V_D , 20 V / div., 10 ms / div.
 CH2: I_D , 2 A / div., 10 ms / div.
 Zoom: 10 μ s / div.
 PIV = 62.372 V, $I_{D(MAX)} = 5.2332$ A.

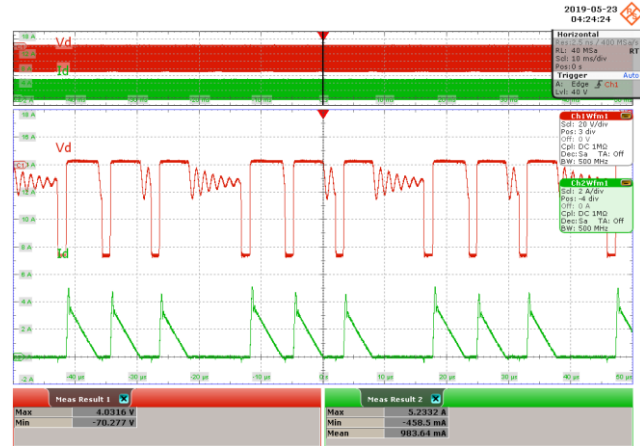

Figure 58 – 265 VAC 50 Hz.
 CH1: V_D , 20 V / div., 10 ms / div.
 CH2: I_D , 2 A / div., 10 ms / div.
 Zoom: 10 μ s / div.
 PIV = 70.277 V, $I_{D(MAX)} = 5.2332$ A.

11.3.3.2 0% Load

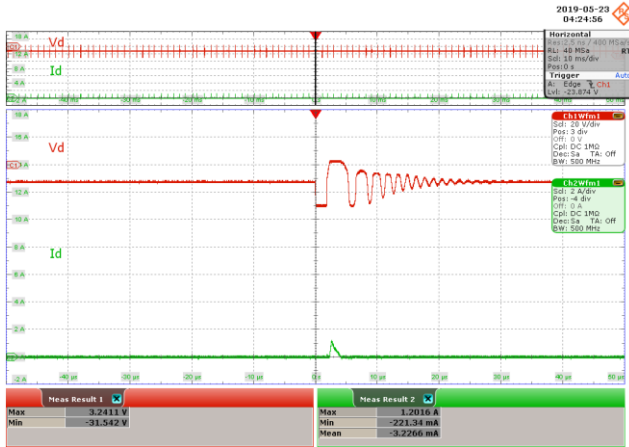

Figure 59 – 85 VAC 60 Hz.
 CH1: V_D , 20 V / div., 10 ms / div.
 CH2: I_D , 2 A / div., 10 ms / div.
 Zoom: 10 μ s / div.
 PIV = 31.542 V, $I_{D(MAX)}$ = 1.2016 A.

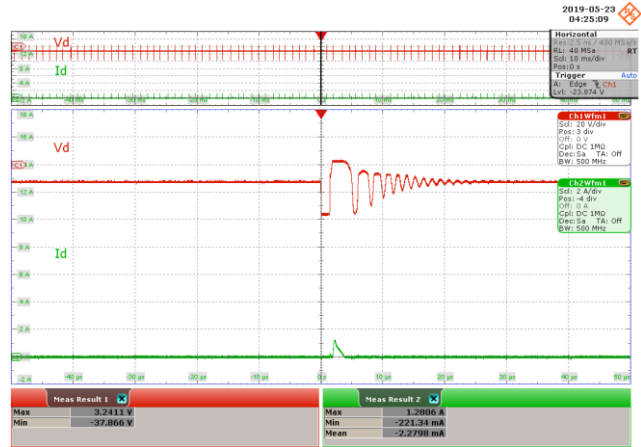

Figure 60 – 115 VAC 60 Hz.
 CH1: V_D , 20 V / div., 10 ms / div.
 CH2: I_D , 2 A / div., 10 ms / div.
 Zoom: 10 μ s / div.
 PIV = 37.866 V, $I_{D(MAX)}$ = 1.2806 A.

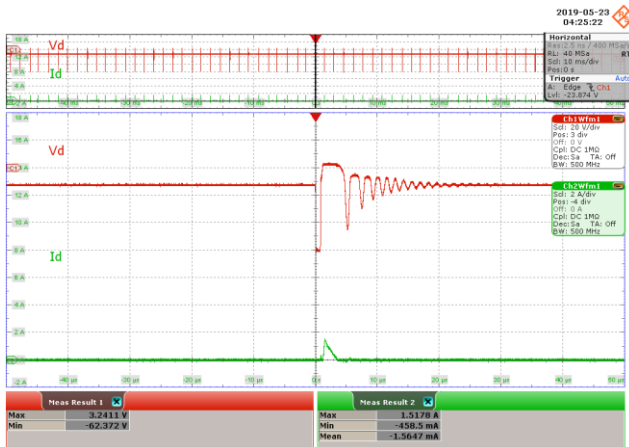

Figure 61 – 230 VAC 50 Hz.
 CH1: V_D , 20 V / div., 10 ms / div.
 CH2: I_D , 2 A / div., 10 ms / div.
 Zoom: 10 μ s / div.
 PIV = 62.372 V, $I_{D(MAX)}$ = 1.5178 A.

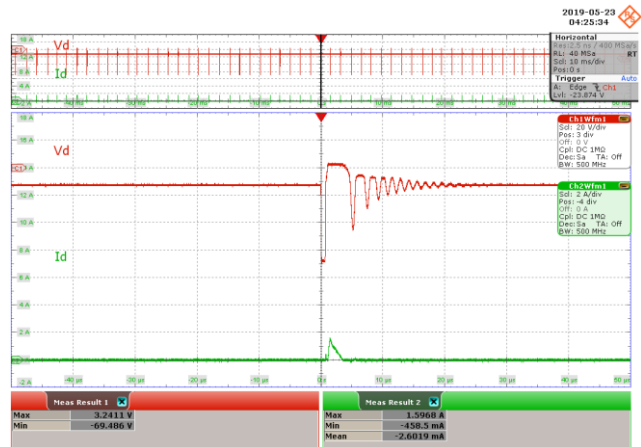

Figure 62 – 265 VAC 50 Hz.
 CH1: V_D , 20 V / div., 10 ms / div.
 CH2: I_D , 2 A / div., 10 ms / div.
 Zoom: 10 μ s / div.
 PIV = 69.486 V, $I_{D(MAX)}$ = 1.5968 A.



11.3.4 Output Diode Voltage and Current at Start-up Operation

11.3.4.1 100% Load

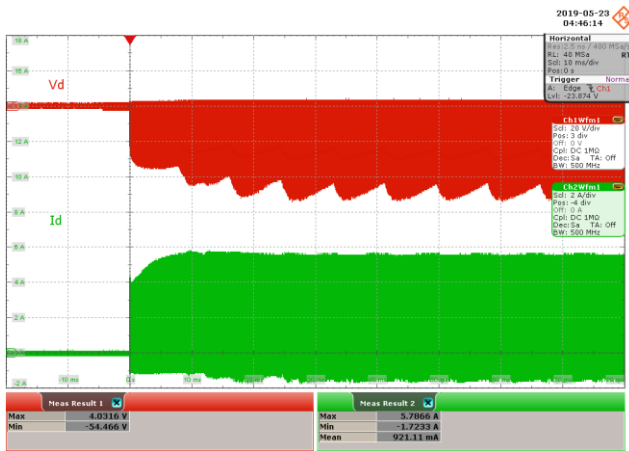

Figure 63 – 85 VAC 60 Hz.
 CH1: V_D , 20 V / div., 10 ms / div.
 CH2: I_D , 2 A / div., 10 ms / div.
 PIV = 54.466 V, $I_{D(MAX)}$ = 5.7866 A.

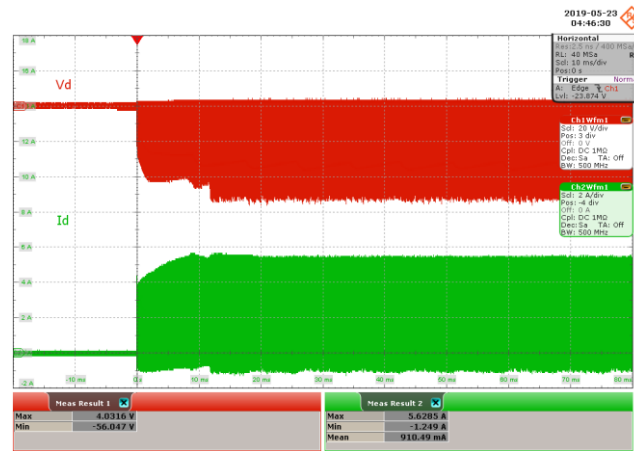

Figure 64 – 115 VAC 60 Hz.
 CH1: V_D , 20 V / div., 10 ms / div.
 CH2: I_D , 2 A / div., 10 ms / div.
 PIV = 56.047 V, $I_{D(MAX)}$ = 5.6285 A.

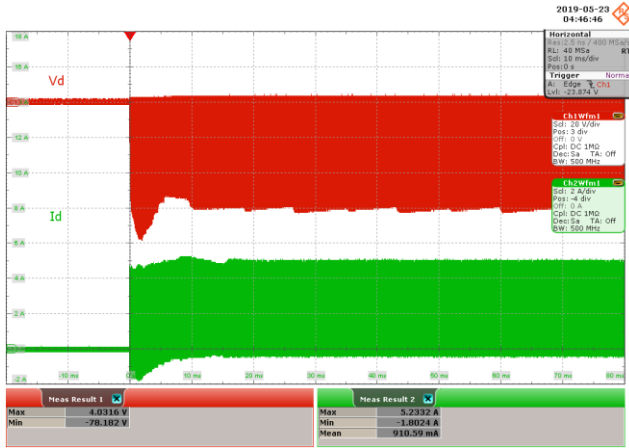

Figure 65 – 230 VAC 50 Hz.
 CH1: V_D , 20 V / div., 10 ms / div.
 CH2: I_D , 2 A / div., 10 ms / div.
 PIV = 78.182 V, $I_{D(MAX)}$ = 5.2332 A.

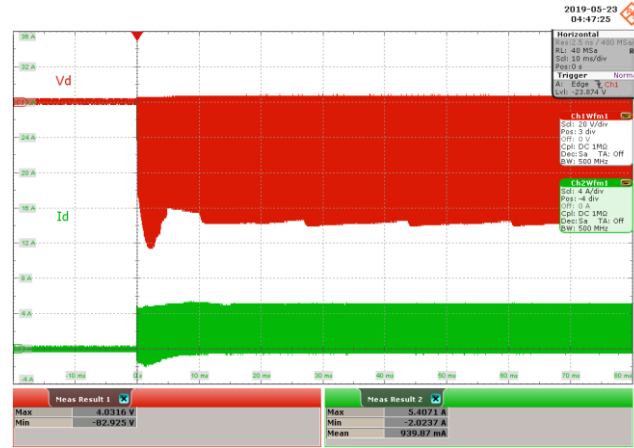

Figure 66 – 265 VAC 50 Hz.
 CH1: V_D , 20 V / div., 10 ms / div.
 CH2: I_D , 4 A / div., 10 ms / div.
 PIV = 82.925 V, $I_{D(MAX)}$ = 5.4071 A.

11.3.4.2 0% Load



Figure 67 – 85 VAC 60 Hz.
 CH1: V_D , 20 V / div., 10 ms / div.
 CH2: I_D , 2 A / div., 10 ms / div.
 PIV = 41.818 V, $I_{D(MAX)}$ = 5.3913 A.

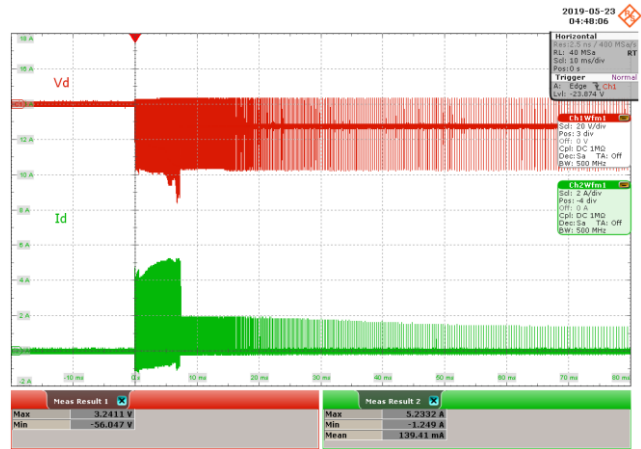

Figure 68 – 115 VAC 60 Hz.
 CH1: V_D , 20 V / div., 10 ms / div.
 CH2: I_D , 2 A / div., 10 ms / div.
 PIV = 56.047 V, $I_{D(MAX)}$ = 5.2332 A.

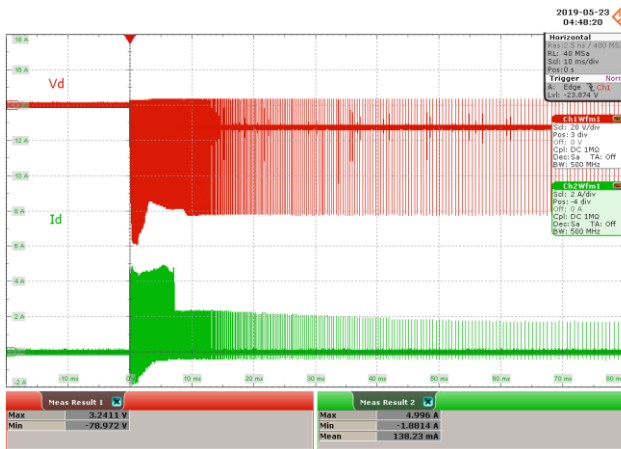

Figure 69 – 230 VAC 50 Hz.
 CH1: V_D , 20 V / div., 10 ms / div.
 CH2: I_D , 2 A / div., 10 ms / div.
 PIV = 78.972 V, $I_{D(MAX)}$ = 4.996 A.

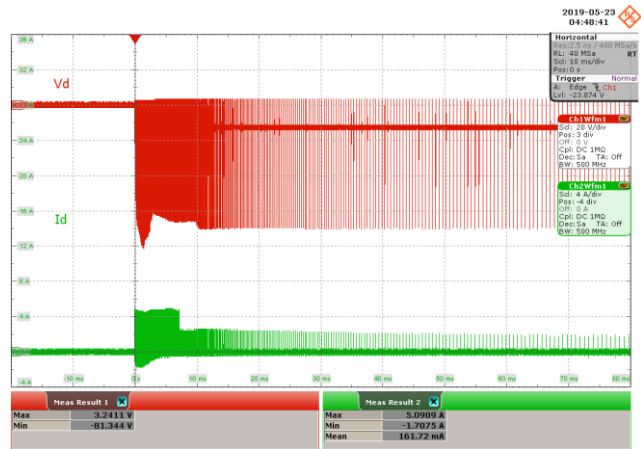

Figure 70 – 265 VAC 50 Hz.
 CH1: V_D , 20 V / div., 10 ms / div.
 CH2: I_D , 4 A / div., 10 ms / div.
 PIV = 81.344 V, $I_{D(MAX)}$ = 5.0909 A.



11.4 **Brown-In and Brown-Out**

11.4.1 Without UV Sensing

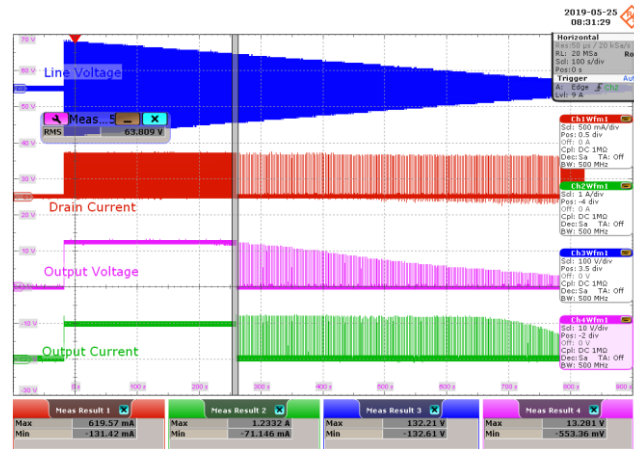
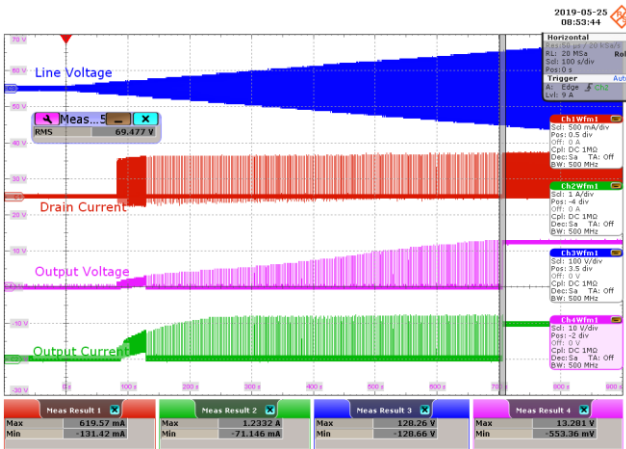

Figure 71 – Brown-In, Full Load.

CH1: I_{DS} , 500 mA / div., 100 s / div.
 CH2: I_{OUT} , 1 A / div., 100 s / div.
 CH3: V_{IN} , 100 V / div., 100 s / div.
 CH4: V_{OUT} , 10 V / div., 100 s / div.

Figure 72 – Brown-Out, Full Load.

CH1: I_{DS} , 500 mA / div., 100 s / div.
 CH2: I_{OUT} , 1 A / div., 100 s / div.
 CH3: V_{IN} , 100 V / div., 100 s / div.
 CH4: V_{OUT} , 10 V / div., 100 s / div.

11.4.2 With UV sensing

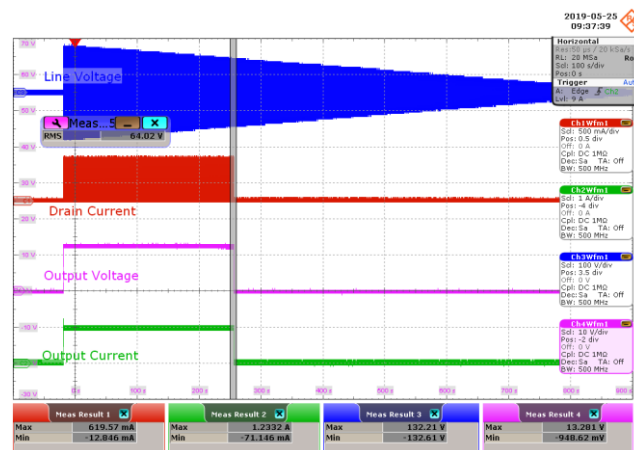
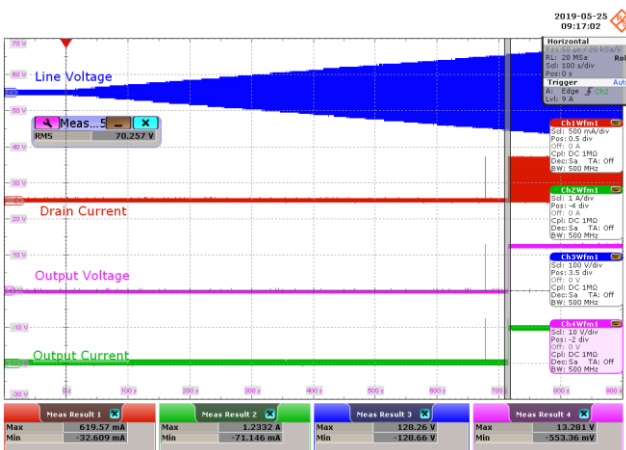

Figure 73 – Brown-In, Full Load.

CH1: I_{DS} , 500 mA / div., 100 s / div.
 CH2: I_{OUT} , 1 A / div., 100 s / div.
 CH3: V_{IN} , 100 V / div., 100 s / div.
 CH4: V_{OUT} , 10 V / div., 100 s / div.

Figure 74 – Brown-Out, Full Load.

CH1: I_{DS} , 500 mA / div., 100 s / div.
 CH2: I_{OUT} , 1 A / div., 100 s / div.
 CH3: V_{IN} , 100 V / div., 100 s / div.
 CH4: V_{OUT} , 10 V / div., 100 s / div.

11.5 Fault Conditions

11.5.1 Output Overvoltage

11.5.1.1 100% Load, 25 °C

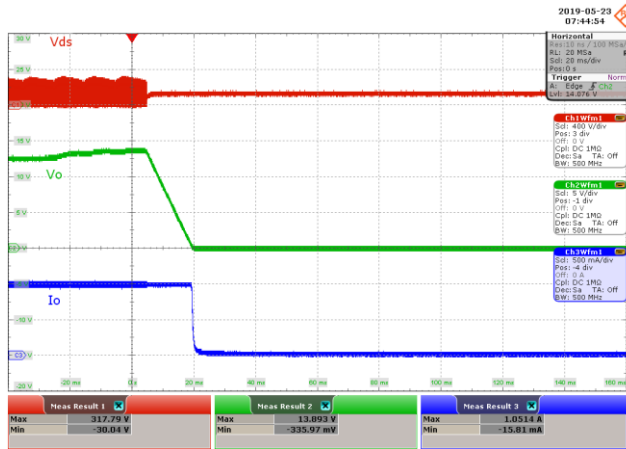

Figure 75 – 85 VAC 60 Hz.
 CH1: V_{DS} , 400 V / div., 20 ms / div.
 CH2: V_{OUT} , 5 V / div., 20 ms / div.
 CH3: I_{OUT} , 500 mA / div., 20 ms / div.
 $V_{OUT(MAX)} = 13.893$ V.



Figure 76 – 115 VAC 60 Hz.
 CH1: V_{DS} , 400 V / div., 20 ms / div.
 CH2: V_{OUT} , 5 V / div., 20 ms / div.
 CH3: I_{OUT} , 500 mA / div., 20 ms / div.
 $V_{OUT(MAX)} = 14.289$ V.

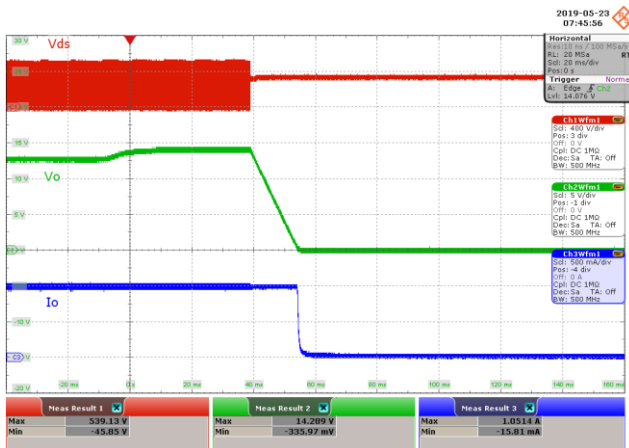

Figure 77 – 230 VAC 50 Hz.
 CH1: V_{DS} , 400 V / div., 20 ms / div.
 CH2: V_{OUT} , 5 V / div., 20 ms / div.
 CH3: I_{OUT} , 500 mA / div., 20 ms / div.
 $V_{OUT(MAX)} = 14.289$ V.

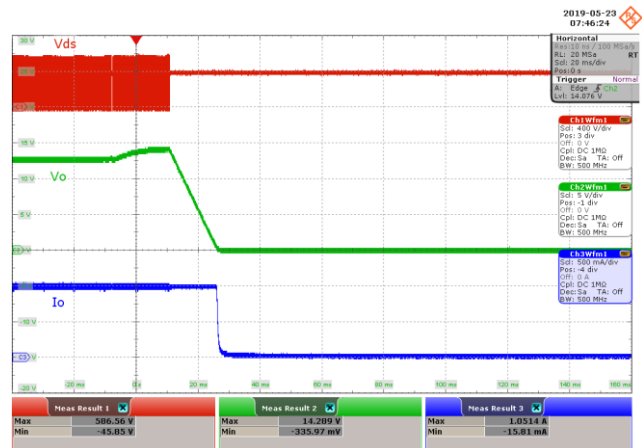

Figure 78 – 265 VAC 50 Hz.
 CH1: V_{DS} , 400 V / div., 20 ms / div.
 CH2: V_{OUT} , 5 V / div., 20 ms / div.
 CH3: I_{OUT} , 500 mA / div., 20 ms / div.
 $V_{OUT(MAX)} = 14.289$ V.



11.5.1.2 0% Load, 25 °C

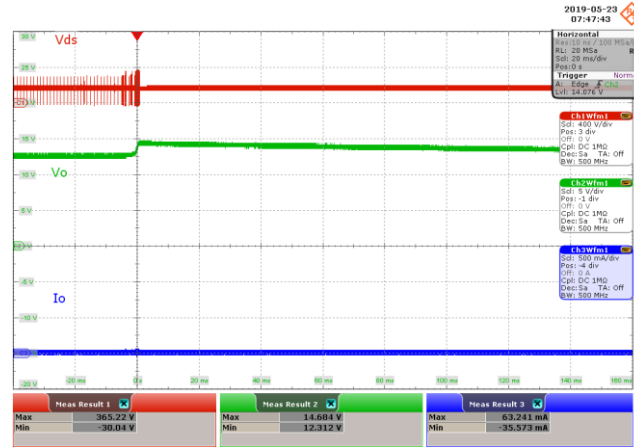
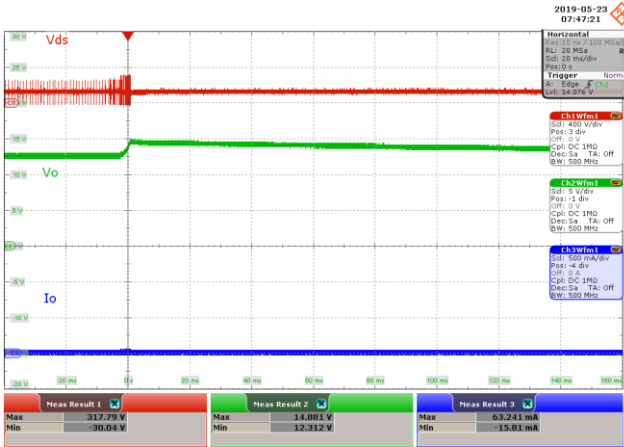

Figure 79 – 85 VAC 60 Hz.

CH1: V_{DS}, 400 V / div., 20 ms / div.
 CH2: V_{OUT}, 5 V / div., 20 ms / div.
 CH3: I_{OUT}, 500 mA / div., 20 ms / div.
 V_{OUT(MAX)} = 14.881 V.

Figure 80 – 115 VAC 60 Hz.

CH1: V_{DS}, 400 V / div., 20 ms / div.
 CH2: V_{OUT}, 5 V / div., 20 ms / div.
 CH3: I_{OUT}, 500 mA / div., 20 ms / div.
 V_{OUT(MAX)} = 14.684 V.

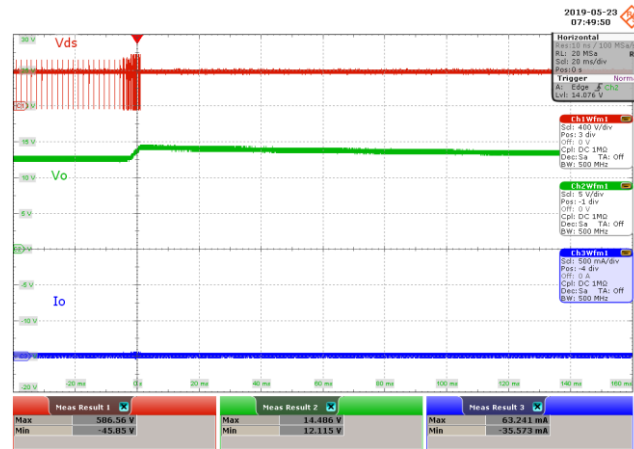
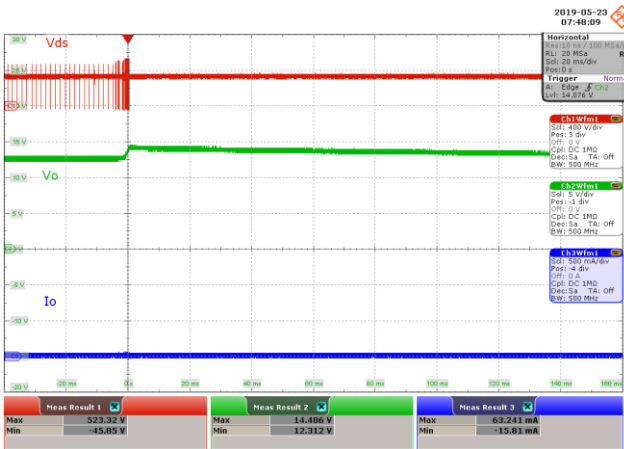

Figure 81 – 230 VAC 50 Hz.

CH1: V_{DS}, 400 V / div., 20 ms / div.
 CH2: V_{OUT}, 5 V / div., 20 ms / div.
 CH3: I_{OUT}, 500 mA / div., 20 ms / div.
 V_{OUT(MAX)} = 14.486 V.

Figure 82 – 265 VAC 50 Hz.

CH1: V_{DS}, 400 V / div., 20 ms / div.
 CH2: V_{OUT}, 5 V / div., 20 ms / div.
 CH3: I_{OUT}, 500 mA / div., 20 ms / div.
 V_{OUT(MAX)} = 14.486 V.

11.5.1.3 OVP at 50 °C

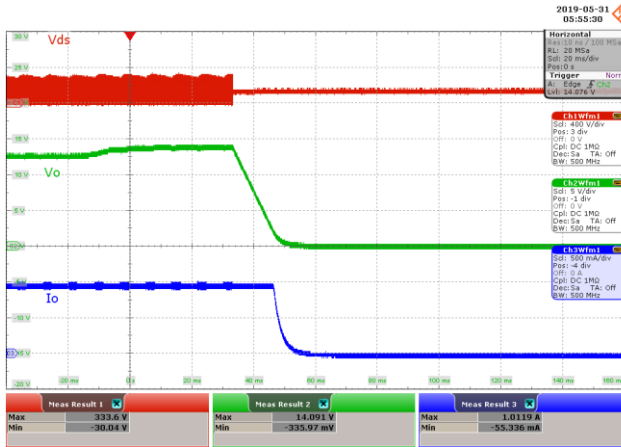

Figure 83 – 85 VAC 60 Hz, Full Load.
 CH1: V_{DS} , 400 V / div., 20 ms / div.
 CH2: V_{OUT} , 5 V / div., 20 ms / div.
 CH3: I_{OUT} , 500 mA / div., 20 ms / div.
 $V_{OUT(MAX)} = 14.091$ V.

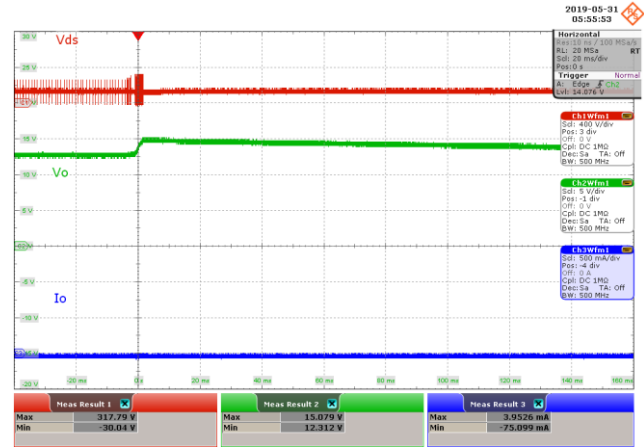

Figure 84 – 85 VAC 60 Hz, No-Load.
 CH1: V_{DS} , 400 V / div., 20 ms / div.
 CH2: V_{OUT} , 5 V / div., 20 ms / div.
 CH3: I_{OUT} , 500 mA / div., 20 ms / div.
 $V_{OUT(MAX)} = 15.079$ V.

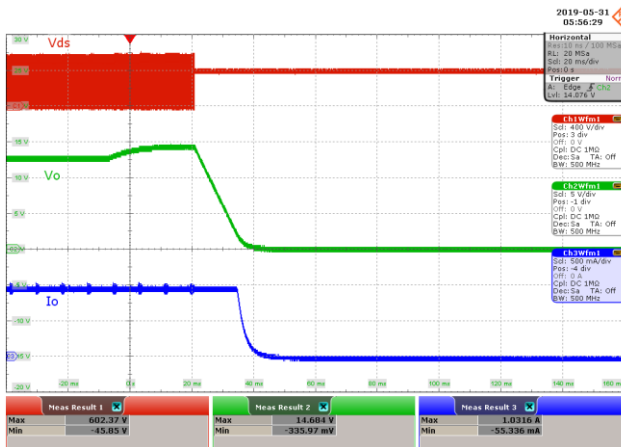

Figure 85 – 265 VAC 50 Hz, Full Load.
 CH1: V_{DS} , 400 V / div., 20 ms / div.
 CH2: V_{OUT} , 5 V / div., 20 ms / div.
 CH3: I_{OUT} , 500 mA / div., 20 ms / div.
 $V_{OUT(MAX)} = 14.684$ V.

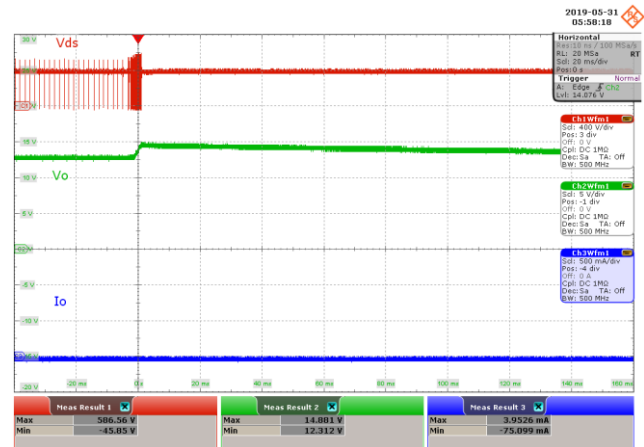

Figure 86 – 265 VAC 50 Hz, No-Load.
 CH1: V_{DS} , 400 V / div., 20 ms / div.
 CH2: V_{OUT} , 5 V / div., 20 ms / div.
 CH3: I_{OUT} , 500 mA / div., 20 ms / div.
 $V_{OUT(MAX)} = 14.881$ V.



11.5.1.4 OVP at 0 °C

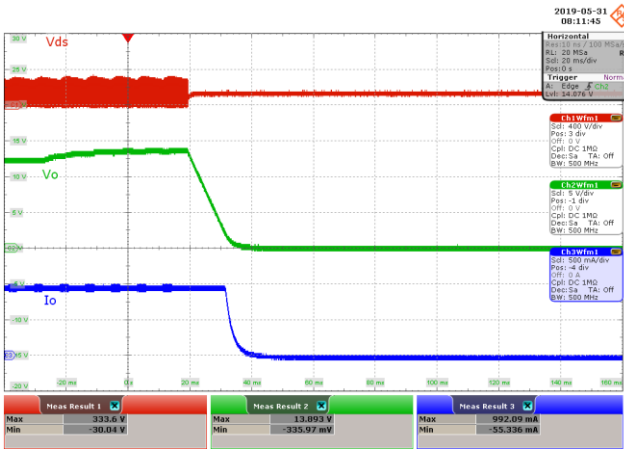

Figure 87 – 85 VAC 60 Hz, Full Load.

CH1: V_{DS} , 400 V / div., 20 ms / div.
 CH2: V_{OUT} , 5 V / div., 20 ms / div.
 CH3: I_{OUT} , 500 mA / div., 20 ms / div.
 $V_{OUT(MAX)} = 13.893$ V.

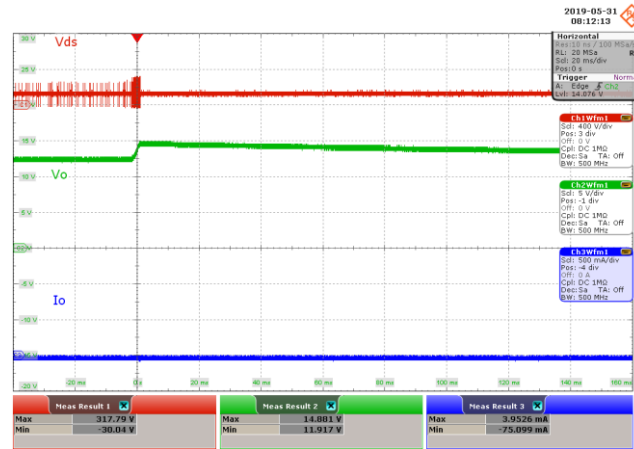

Figure 88 – 85 VAC 60 Hz, No-Load.

CH1: V_{DS} , 400 V / div., 20 ms / div.
 CH2: V_{OUT} , 5 V / div., 20 ms / div.
 CH3: I_{OUT} , 500 mA / div., 20 ms / div.
 $V_{OUT(MAX)} = 14.881$ V.

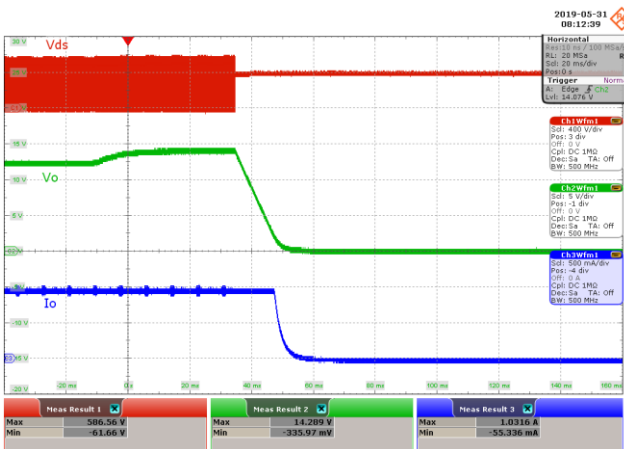

Figure 89 – 265 VAC 50 Hz, Full Load.

CH1: V_{DS} , 400 V / div., 20 ms / div.
 CH2: V_{OUT} , 5 V / div., 20 ms / div.
 CH3: I_{OUT} , 500 mA / div., 20 ms / div.
 $V_{OUT(MAX)} = 14.289$ V.

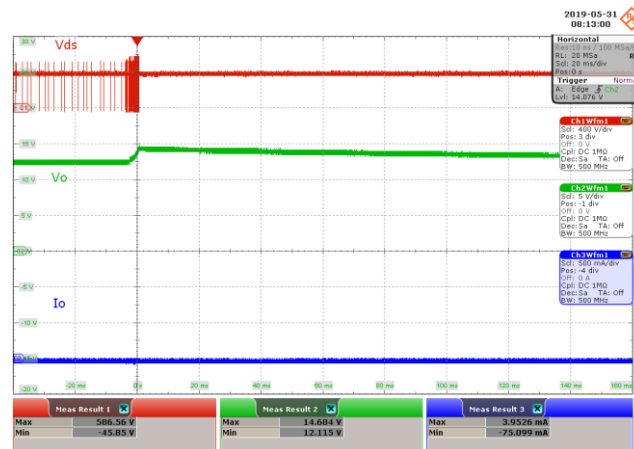

Figure 90 – 265 VAC 50 Hz, No-Load.

CH1: V_{DS} , 400 V / div., 20 ms / div.
 CH2: V_{OUT} , 5 V / div., 20 ms / div.
 CH3: I_{OUT} , 500 mA / div., 20 ms / div.
 $V_{OUT(MAX)} = 14.684$ V.

11.5.2 Output Short Circuit

Test Condition: Short circuit applied at normal operation

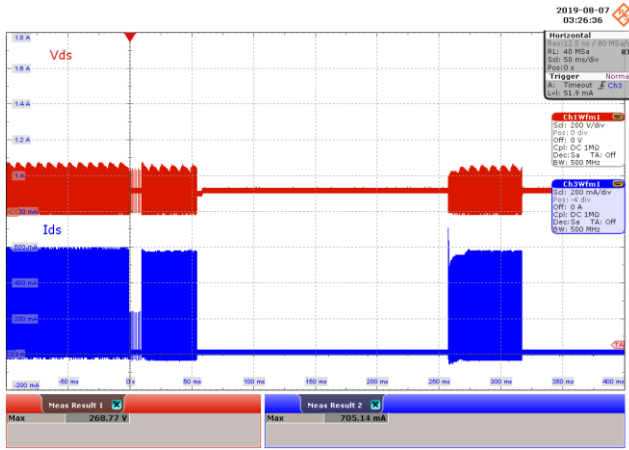

Figure 91 – 85 VAC 60 Hz.
 CH1: V_{DS} , 200 V / div., 50 ms / div.
 CH3: I_{DS} , 200 mA / div., 50 ms / div.
 $V_{DS,MAX} = 268.77$ V.
 $I_{DS,MAX} = 705.14$ mA.

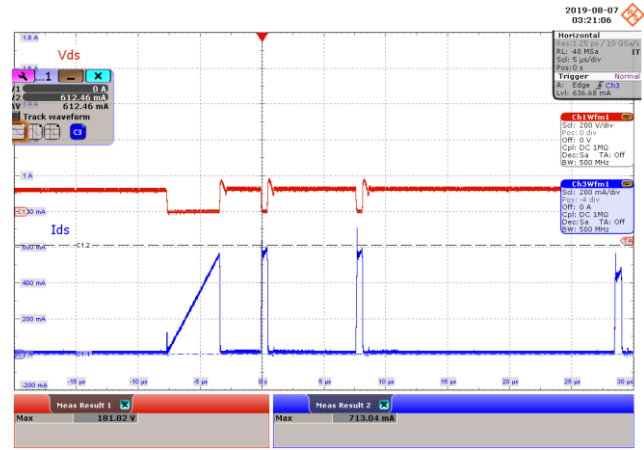

Figure 92 – 85 VAC 60 Hz.
 CH1: V_{DS} , 200 V / div., 5 μ s / div.
 CH3: I_{DS} , 200 mA / div., 5 μ s / div.
 $I_{LIM,MAX} = 612.46$ mA

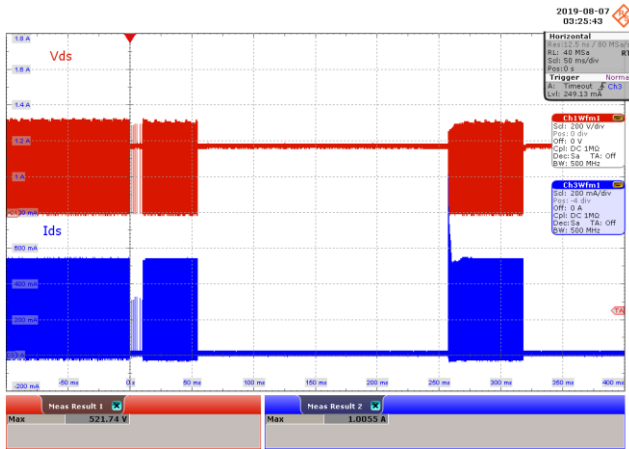

Figure 93 – 265 VAC 50 Hz.
 CH1: V_{DS} , 200 V / div., 50 ms / div.
 CH3: I_{DS} , 200 mA / div., 50 ms / div.
 $V_{DS,MAX} = 521.74$ V.
 $I_{DS,MAX} = 1.0055$ A.

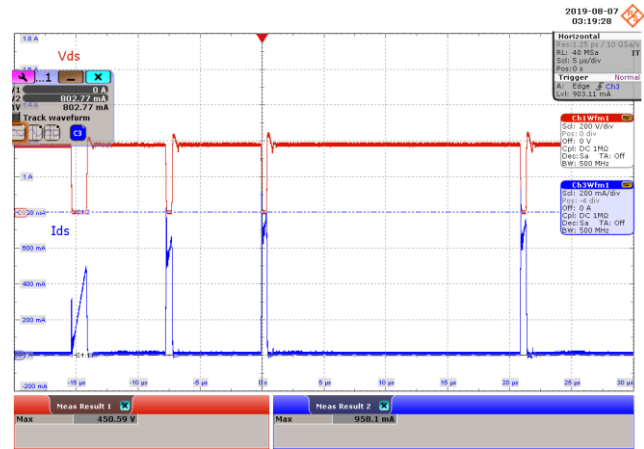

Figure 94 – 265 VAC 50 Hz.
 CH1: V_{DS} , 200 V / div., 5 μ s / div.
 CH3: I_{DS} , 200 mA / div., 5 μ s / div.
 $I_{LIM,MAX} = 802.77$ mA



11.5.3 Output Overload

Test Condition: Output current step from 1A to 1.3A

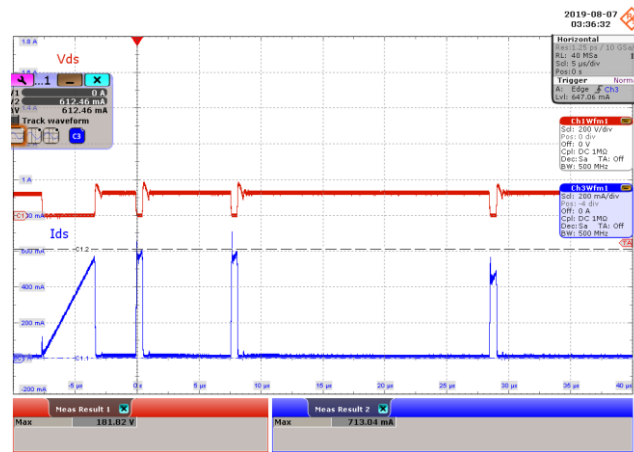
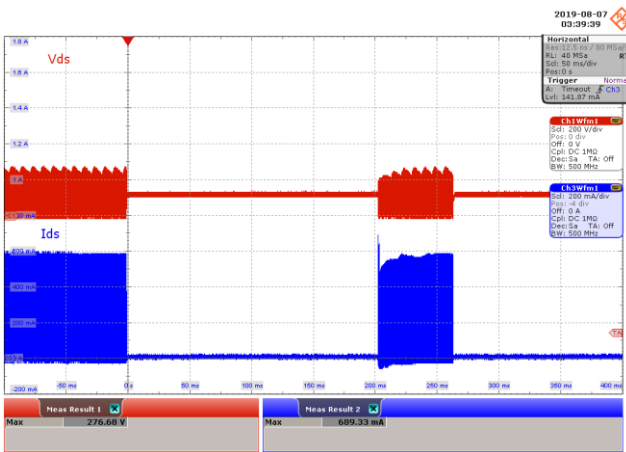

Figure 95 – 85 VAC 60 Hz.

CH1: V_{DS} , 200 V / div., 50 ms / div.
 CH3: I_{DS} , 200 mA / div., 50 ms / div.
 $V_{DS,MAX}$ = 276.68 V.
 $I_{DS,MAX}$ = 689.33 mA.

Figure 96 – 85 VAC 60 Hz.

CH1: V_{DS} , 200 V / div., 5 μ s / div.
 CH3: I_{DS} , 200 mA / div., 5 μ s / div.
 $I_{LIM,MAX}$ = 713.04 mA

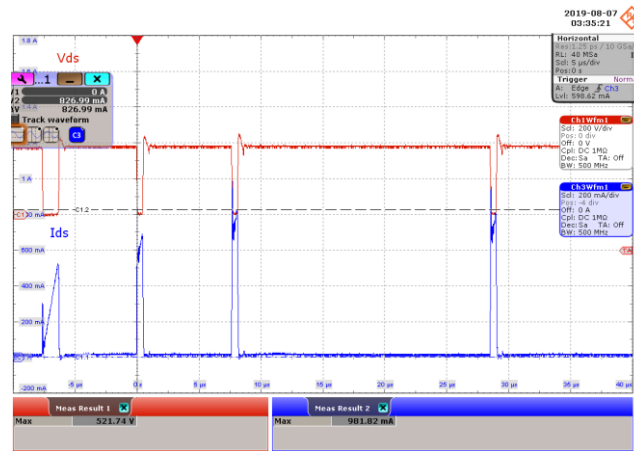
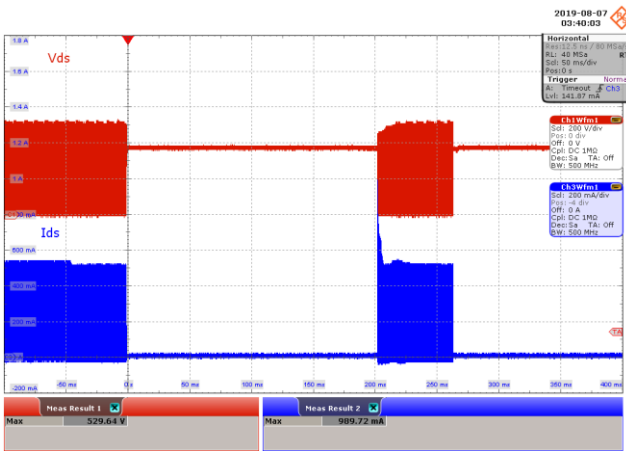

Figure 97 – 265 VAC 50 Hz.

CH1: V_{DS} , 200 V / div., 50 ms / div.
 CH3: I_{DS} , 200 mA / div., 50 ms / div.
 $V_{DS,MAX}$ = 529.64 V.
 $I_{DS,MAX}$ = 989.72 mA.

Figure 98 – 265 VAC 50 Hz.

CH1: V_{DS} , 200 V / div., 5 μ s / div.
 CH3: I_{DS} , 200 mA / div., 5 μ s / div.
 $I_{LIM,MAX}$ = 826.99 mA

Test Condition: Output current slowly ramped from 1A to 1.3A

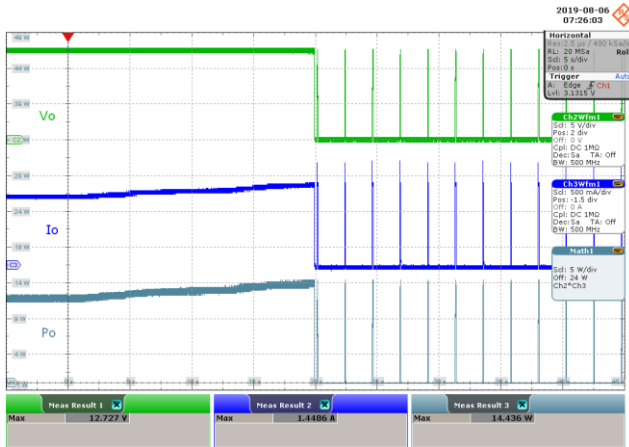

Figure 99 – 85 VAC 60 Hz.
 CH2: V_{OUT} , 5 V / div., 5 s / div.
 CH3: I_{OUT} , 500 mA / div., 5 s / div.
 Math1: P_{OUT} , 5 W / div., 5 s / div.
 $P_{O,MAX} = 14.436\text{ W}$

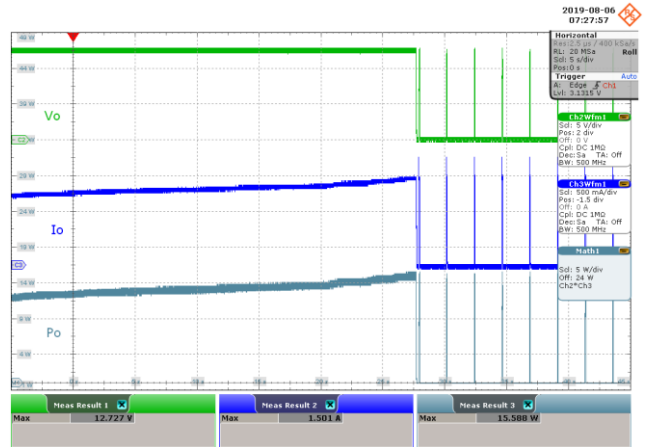

Figure 100 – 115 VAC 60 Hz.
 CH2: V_{OUT} , 5 V / div., 5 s / div.
 CH3: I_{OUT} , 500 mA / div., 5 s / div.
 Math1: P_{OUT} , 5 W / div., 5 s / div.
 $P_{O,MAX} = 15.588\text{ W}$

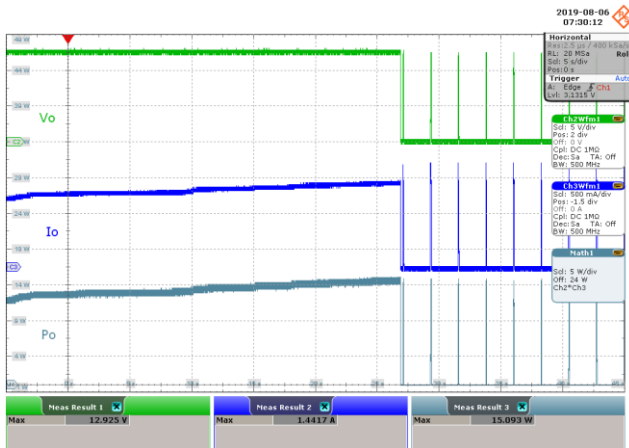

Figure 101 – 230 VAC 50 Hz.
 CH2: V_{OUT} , 5 V / div., 5 s / div.
 CH3: I_{OUT} , 500 mA / div., 5 s / div.
 Math1: P_{OUT} , 5 W / div., 5 s / div.
 $P_{O,MAX} = 15.093\text{ W}$

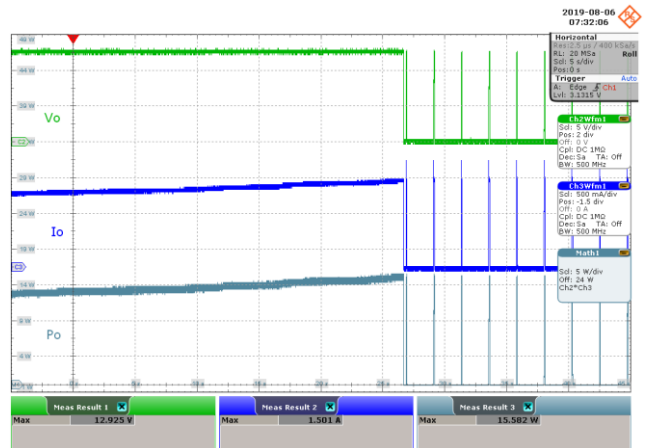

Figure 102 – 265 VAC 50 Hz.
 CH2: V_{OUT} , 5 V / div., 5 s / div.
 CH3: I_{OUT} , 500 mA / div., 5 s / div.
 Math1: P_{OUT} , 5 W / div., 5 s / div.
 $P_{O,MAX} = 15.582\text{ W}$



11.6 **Output Voltage Ripple**

11.6.1 Ripple Measurement Technique

For DC output ripple measurements, a modified oscilloscope test probe must be utilized in order to reduce spurious signals due to pick-up. Details of the probe modification are provided in the Figures below.

The 4987BA probe adapter is affixed with two capacitors tied in parallel across the probe tip. The capacitors include one (1) 0.1 μF / 50 V ceramic type and one (1) 47 μF / 50 V aluminum electrolytic. The aluminum electrolytic type capacitor is polarized, so proper polarity across DC outputs must be maintained (see below).

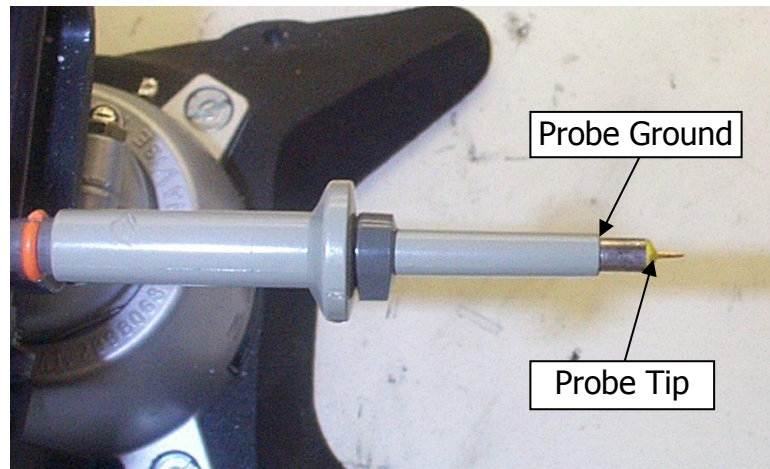

Figure 103 – Oscilloscope Probe Prepared for Ripple Measurement. (End Cap and Ground Lead Removed.)

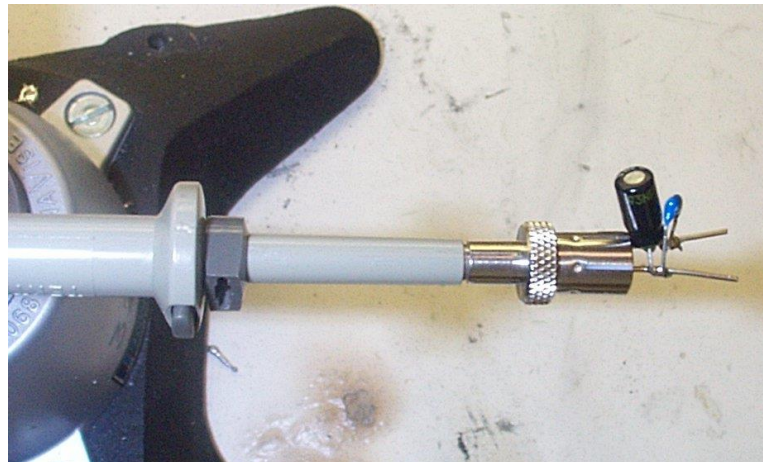

Figure 104 – Oscilloscope Probe with Probe Master (www.probemaster.com) 4987A BNC Adapter. (Modified with wires for ripple measurement, and two parallel decoupling capacitors added.)

11.6.2 Measurement Results

11.6.2.1 100% Load Condition

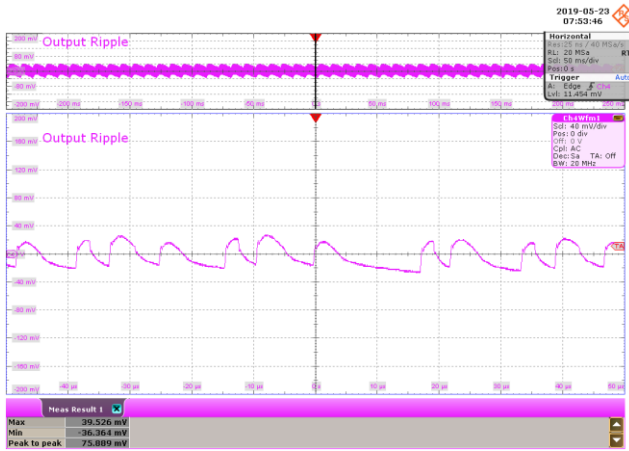

Figure 105 – 85 VAC 60 Hz.
 CH4: V_{OUT} , 40 mV / div., 50 ms / div.
 Zoom: 10 μ s / div.
 Output Ripple = 75.889 mV.

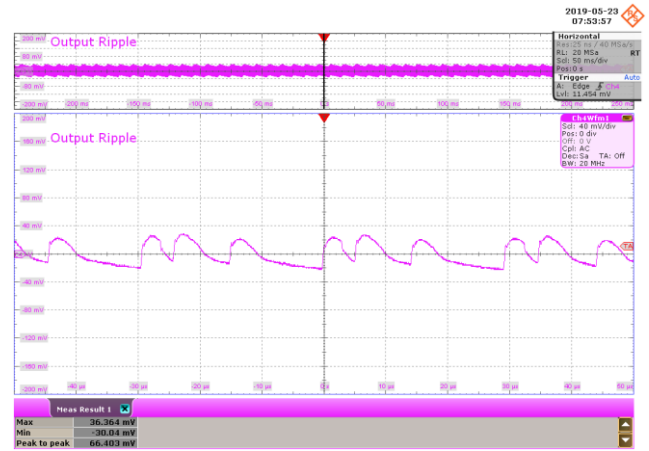

Figure 106 – 115 VAC 60 Hz.
 CH4: V_{OUT} , 40 mV / div., 50 ms / div.
 Zoom: 10 μ s / div.
 Output Ripple = 66.403 mV.

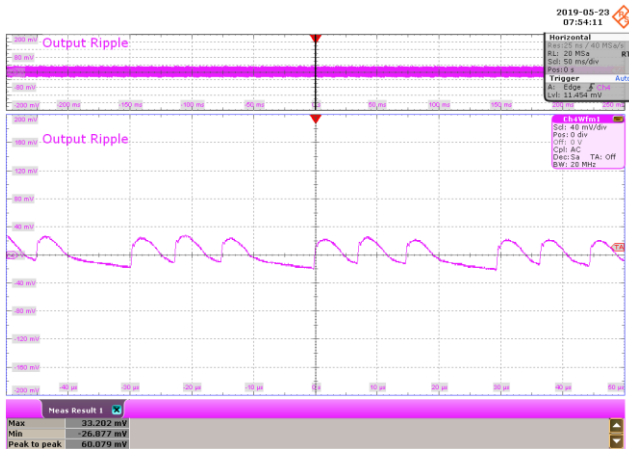

Figure 107 – 230 VAC 50 Hz.
 CH4: V_{OUT} , 40 mV / div., 50 ms / div.
 Zoom: 10 μ s / div.
 Output Ripple = 60.079 mV.

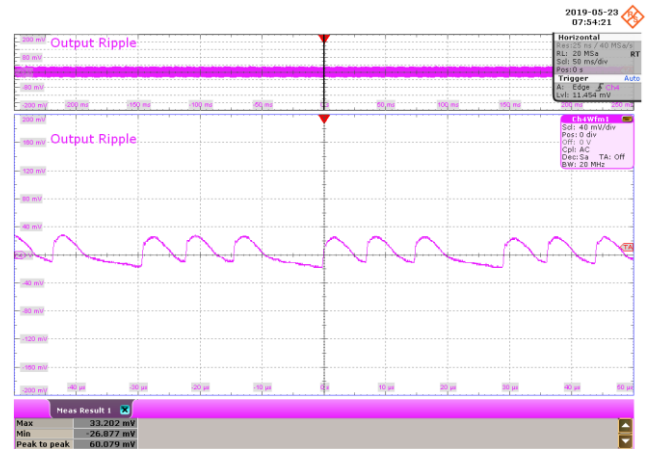

Figure 108 – 265 VAC 50 Hz.
 CH4: V_{OUT} , 40 mV / div., 50 ms / div.
 Zoom: 10 μ s / div.
 Output Ripple = 60.079 mV.



11.6.2.2 75% Load Condition

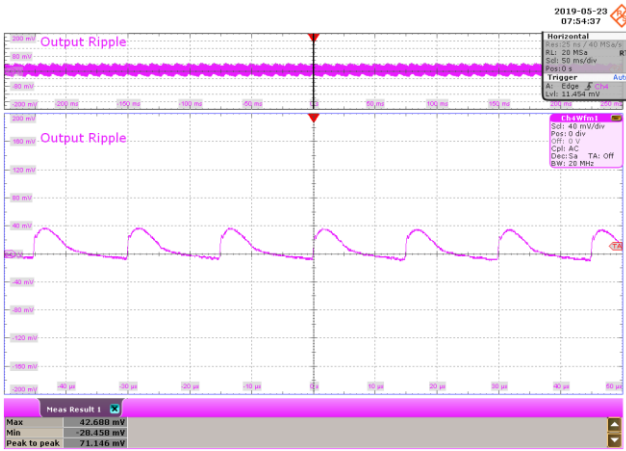

Figure 109 – 85 VAC 60 Hz.
 CH4: V_{OUT} , 40 mV / div., 50 ms / div.
 Zoom: 10 μ s / div.
 Output Ripple = 71.146 mV.

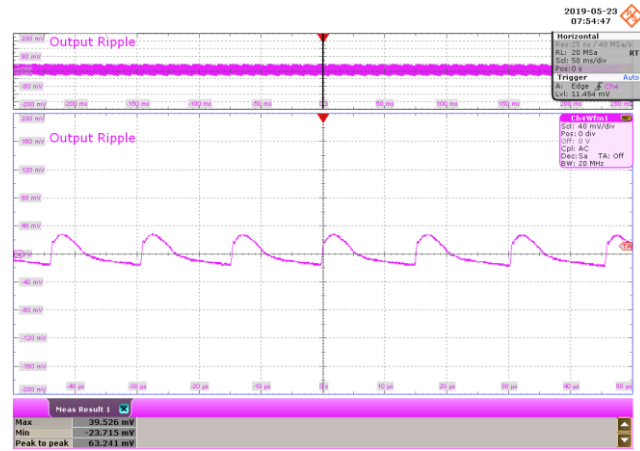

Figure 110 – 115 VAC 60 Hz.
 CH4: V_{OUT} , 40 mV / div., 50 ms / div.
 Zoom: 10 μ s / div.
 Output Ripple = 63.241 mV.

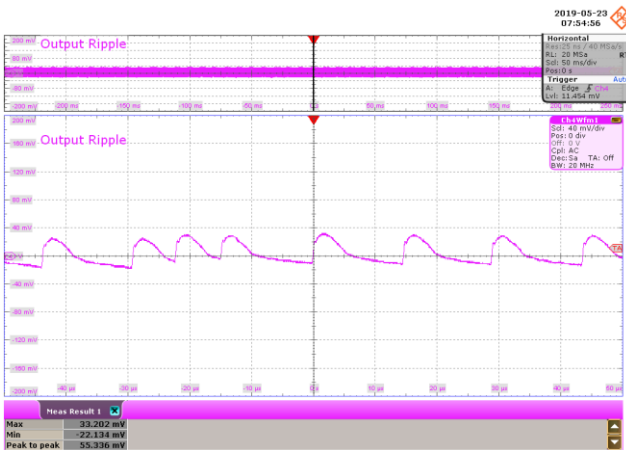

Figure 111 – 230 VAC 50 Hz.
 CH4: V_{OUT} , 40 mV / div., 50 ms / div.
 Zoom: 10 μ s / div.
 Output Ripple = 55.336 mV.

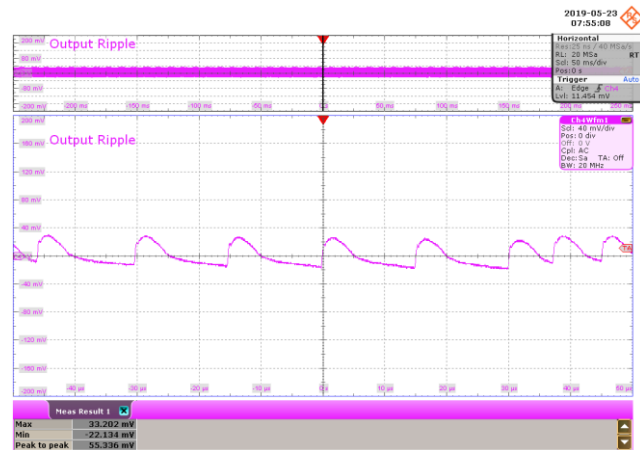

Figure 112 – 265 VAC 50 Hz.
 CH4: V_{OUT} , 40 mV / div., 50 ms / div.
 Zoom: 10 μ s / div.
 Output Ripple = 55.336 mV.

11.6.2.3 50% Load Condition

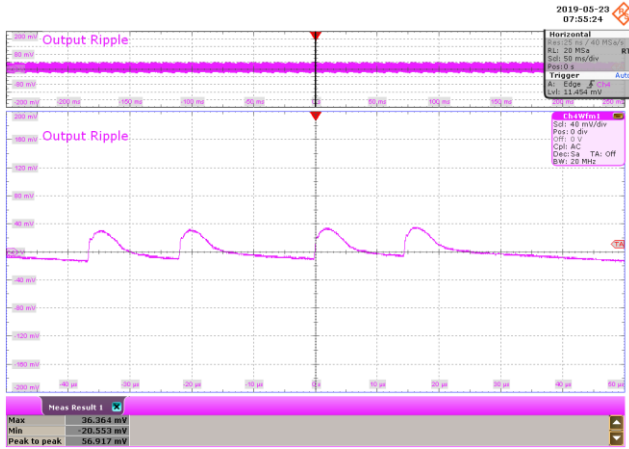

Figure 113 – 85 VAC 60 Hz.
 CH4: V_{OUT} , 40 mV / div., 50 ms / div.
 Zoom: 10 μ s / div.
 Output Ripple = 56.917 mV.

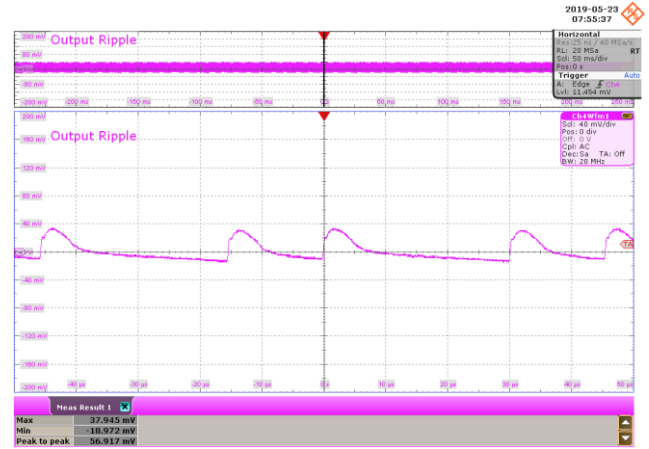

Figure 114 – 115 VAC 60 Hz.
 CH4: V_{OUT} , 40 mV / div., 50 ms / div.
 Zoom: 10 μ s / div.
 Output Ripple = 56.917 mV.

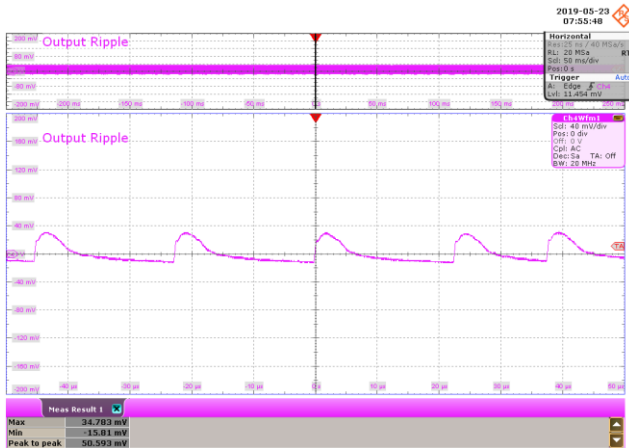

Figure 115 – 230 VAC 50 Hz.
 CH4: V_{OUT} , 40 mV / div., 50 ms / div.
 Zoom: 10 μ s / div.
 Output Ripple = 50.593 mV.

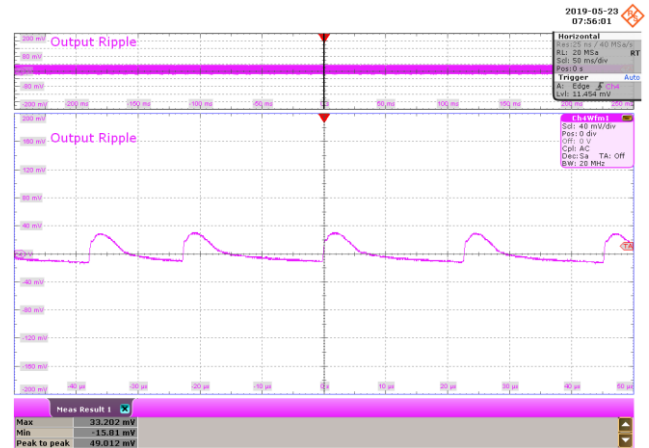

Figure 116 – 265 VAC 50 Hz.
 CH4: V_{OUT} , 40 mV / div., 50 ms / div.
 Zoom: 10 μ s / div.
 Output Ripple = 49.012 mV.



11.6.2.4 25% Load Condition

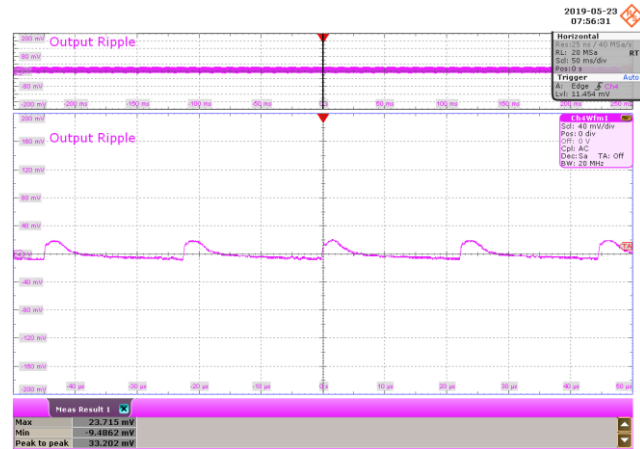
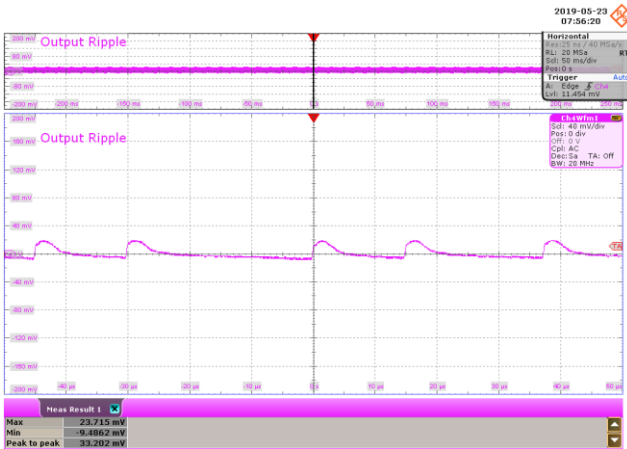

Figure 117 – 85 VAC 60 Hz.
CH4: V_{OUT} , 40 mV / div., 50 ms / div.
Zoom: 10 μ s / div.
Output Ripple = 33.202 mV.

Figure 118 – 115 VAC 60 Hz.
CH4: V_{OUT} , 40 mV / div., 50 ms / div.
Zoom: 10 μ s / div.
Output Ripple = 33.202 mV.

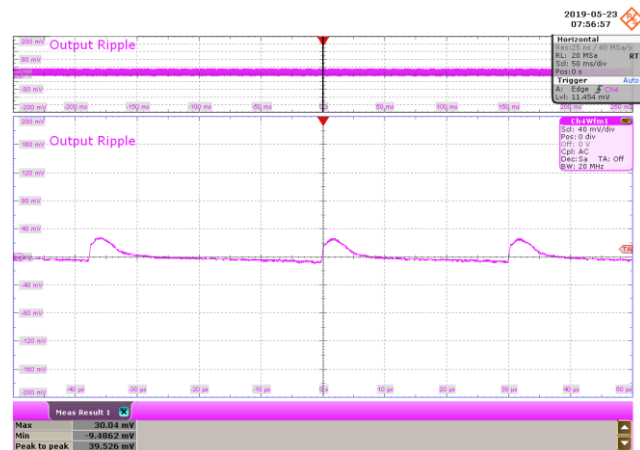
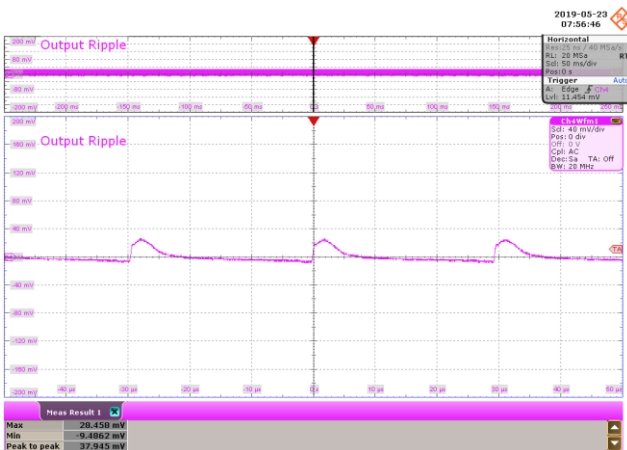

Figure 119 – 230 VAC 50 Hz.
CH4: V_{OUT} , 40 mV / div., 50 ms / div.
Zoom: 10 μ s / div.
Output Ripple = 37.945 mV.

Figure 120 – 265 VAC 50 Hz.
CH4: V_{OUT} , 40 mV / div., 50 ms / div.
Zoom: 10 μ s / div.
Output Ripple = 39.526 mV.

11.6.2.5 0% Load Condition

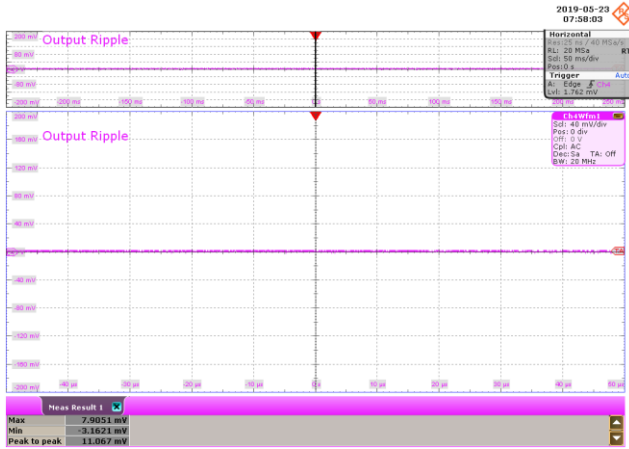

Figure 121 – 85 VAC 60 Hz.
 CH4: V_{OUT} , 40 mV / div., 50 ms / div.
 Zoom: 10 μ s / div.
 Output Ripple = 11.067 mV.

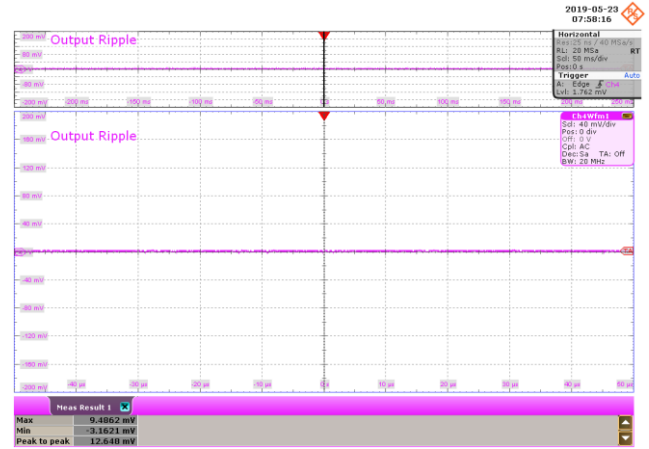

Figure 122 – 115 VAC 60 Hz.
 CH4: V_{OUT} , 40 mV / div., 50 ms / div.
 Zoom: 10 μ s / div.
 Output Ripple = 12.648 mV.

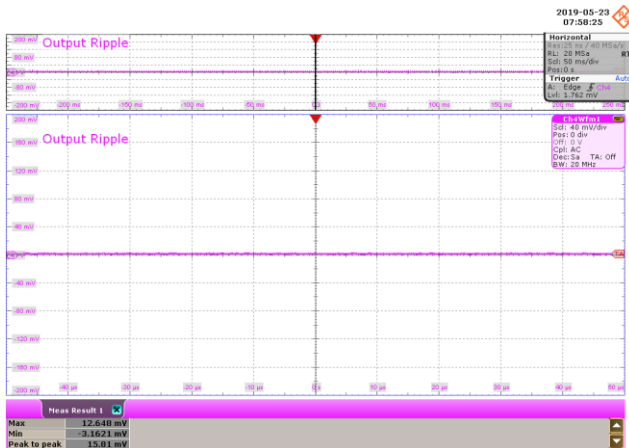

Figure 123 – 230 VAC 50 Hz.
 CH4: V_{OUT} , 40 mV / div., 50 ms / div.
 Zoom: 10 μ s / div.
 Output Ripple = 15.81 mV.

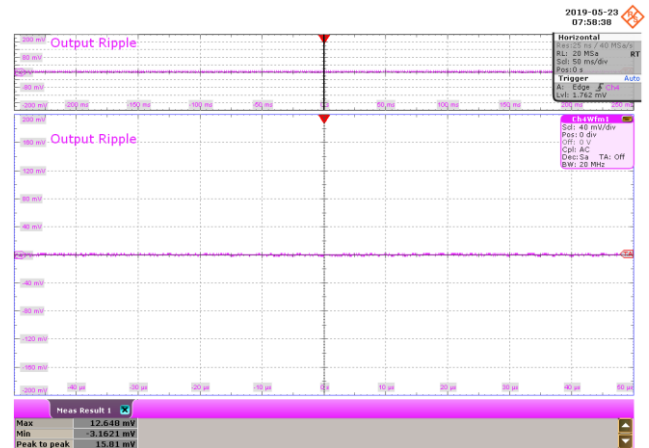

Figure 124 – 265 VAC 50 Hz.
 CH4: V_{OUT} , 40 mV / div., 50 ms / div.
 Zoom: 10 μ s / div.
 Output Ripple = 15.81 mV.

11.6.3 Output Ripple Voltage Graph from 0% - 100%

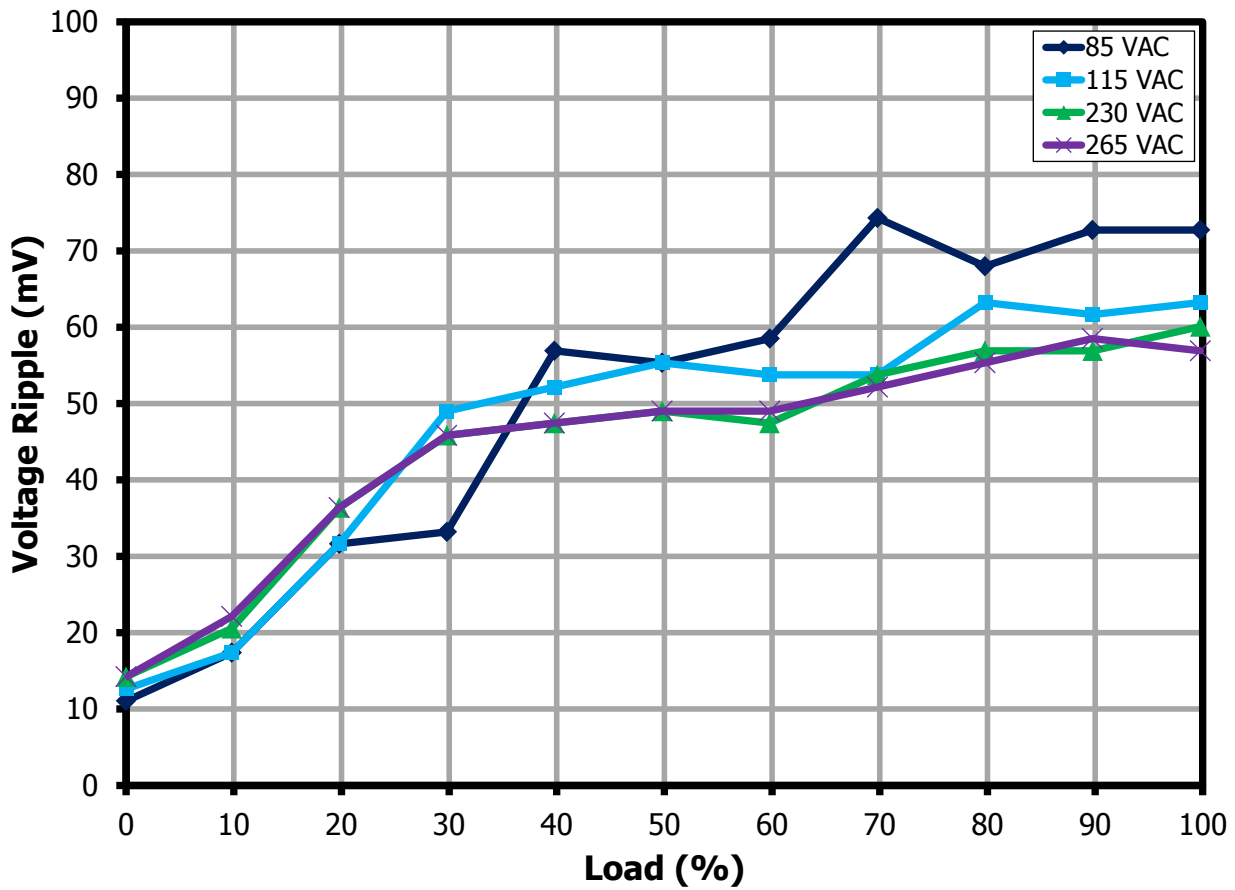

Figure 125 – Measured at the Board Output Terminals at Room Temperature.

12 Thermal Performance

12.1 Test Set-Up

Thermal evaluation was performed under two conditions: (1) room temperature with the circuit board enclosed inside an acrylic box and (2), 50 °C ambient inside a thermal chamber. In both conditions, the circuit is soaked for two hours under full load conditions.

Note: In all thermal testing data, package D (SO-8C) was used instead of package P (DIP-8C).

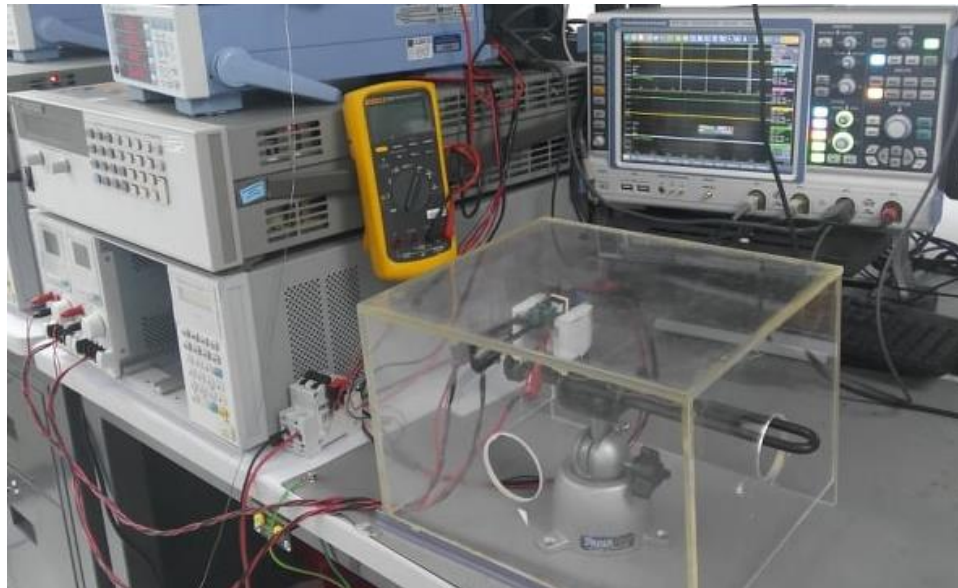

Figure 126 – Thermal Performance Set-up Using an Acrylic Box.



Figure 127 – Thermal Performance Set-up Using Thermal Chamber.

12.2 Thermal Performance at Room Temperature

12.2.1 85 VAC at room temperature

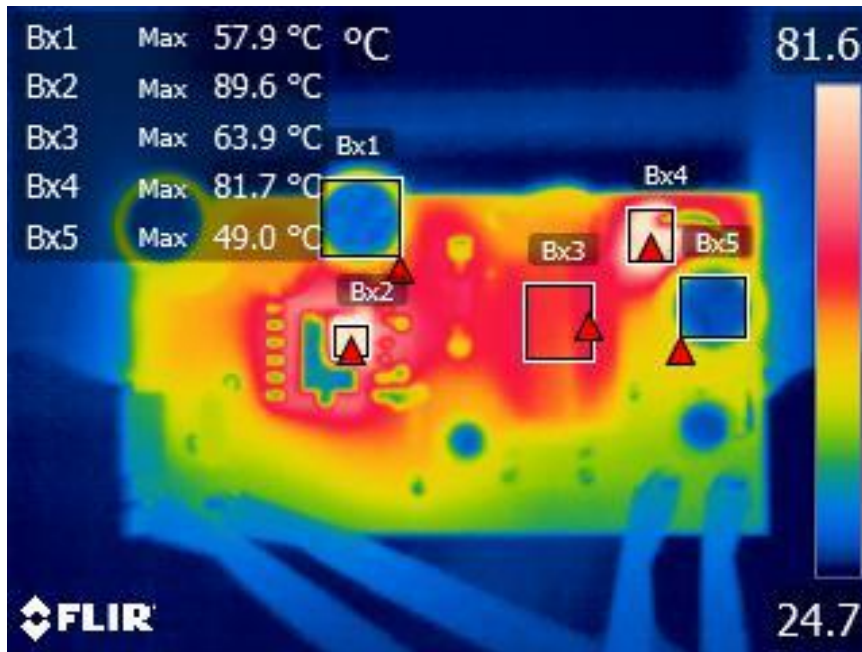

Figure 128 – Thermal Performance at 85 VAC, Full Load Using TNY288D.

Component	Temperature (°C)
Input Capacitor (C2)	57.9
Transformer (T1)	63.9
TNY288 (U1)	89.6
Output Capacitor (C7)	49.0
Output Diode (D3)	81.7
Ambient	26.0

12.2.2 265 VAC at Room Temperature

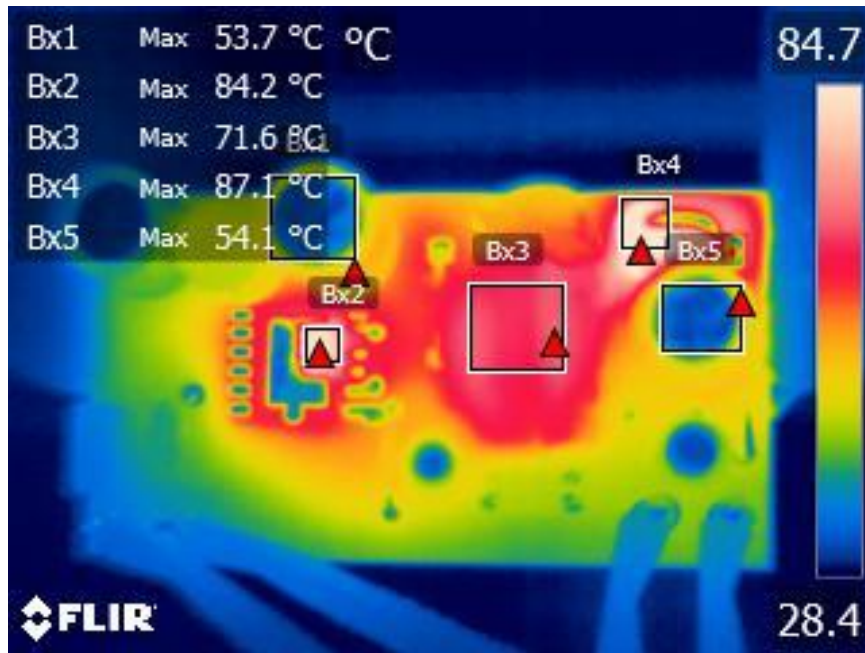

Figure 129 – Thermal Performance at 265 VAC, Full Load Using TNY288D.

Component	Temperature (°C)
Input Capacitor (C2)	53.7
Transformer (T1)	71.6
TNY288 (U1)	84.2
Output Capacitor (C7)	54.1
Output Diode (D3)	87.1
Ambient	26.5

12.3 Thermal Performance at 50 °C

12.3.1 85 VAC at 50 °C

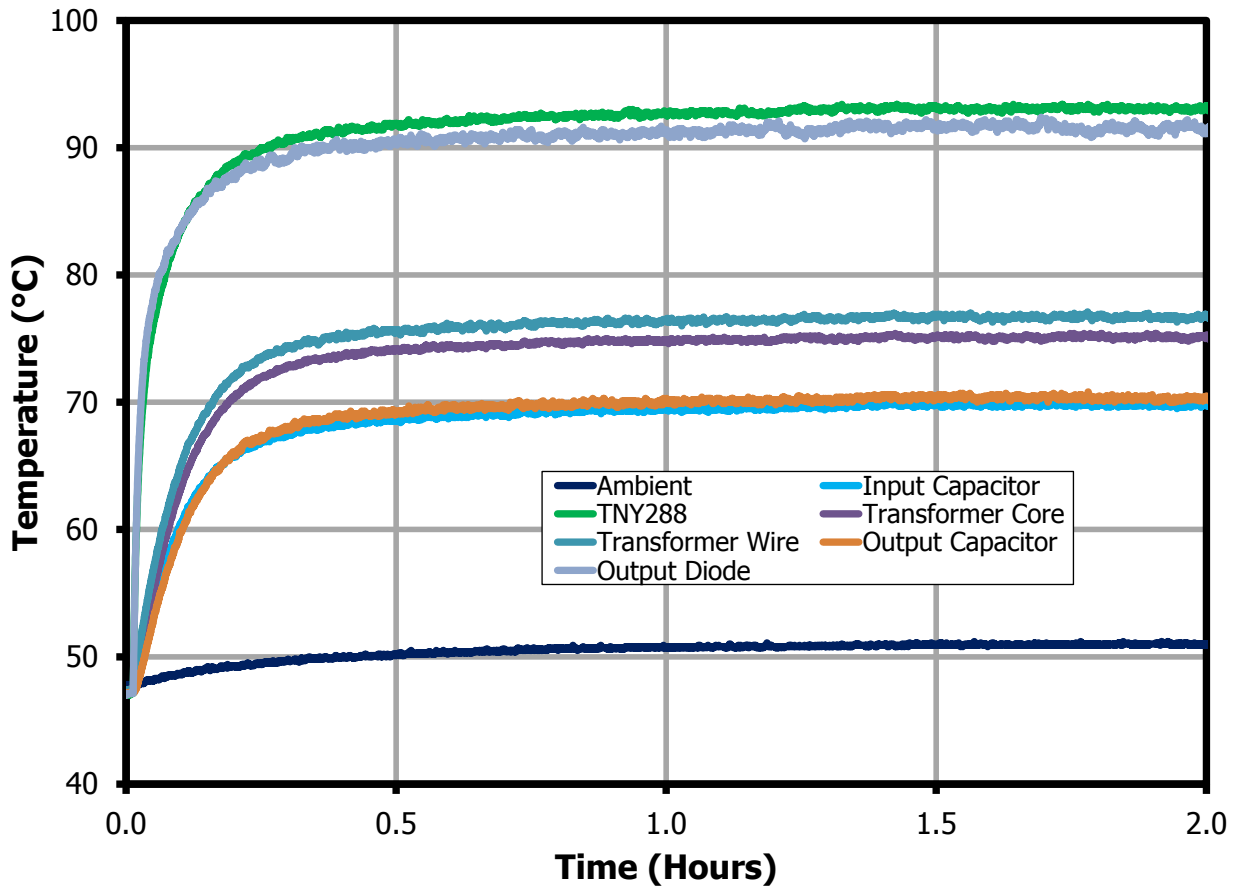

Figure 130 – Thermal Performance at 85 VAC, Full Load Using TNY288D.

Component	Temperature (°C)
Ambient	51.0
Input Capacitor (C2)	69.9
TNY288 (U1)	93.2
Transformer Core (T1)	75.2
Transformer Wire (T1)	76.6
Output Capacitor (C7)	70.3
Output Diode (D3)	91.6

12.3.2 265 VAC at 50 °C

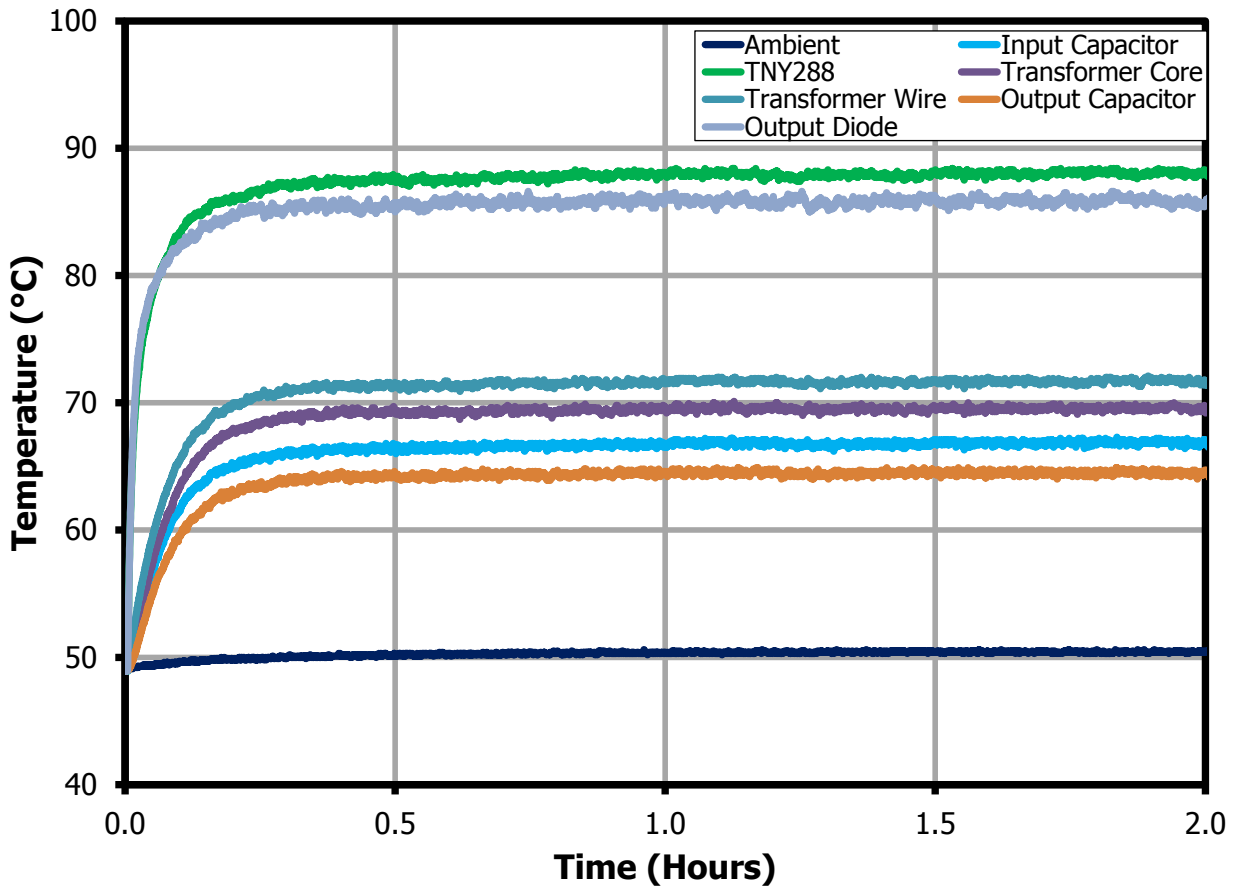

Figure 131 – Thermal Performance at 265 VAC, Full Load Using TNY288D.

Component	Temperature (°C)
Ambient	50.4
Input Capacitor (C2)	66.8
TNY288 (U1)	87.9
Transformer Core (T1)	69.5
Transformer Wire (T1)	71.5
Output Capacitor (C7)	64.2
Output Diode (D3)	85.8



12.4 Over Temperature Protection

12.4.1 OTP at 85 VAC

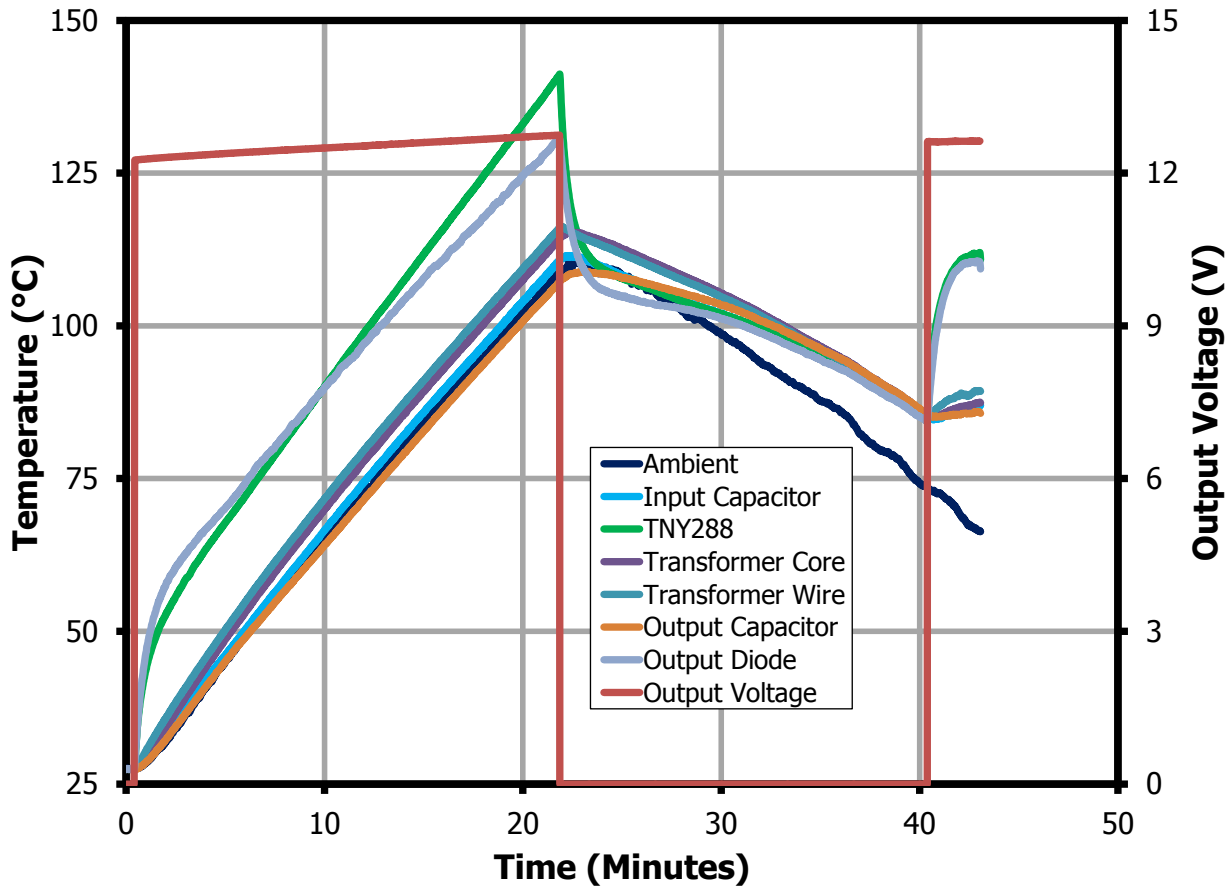

Figure 132 – Over Temperature Protection at 85 VAC Using TNY288D.

Component	At OTP Trigger Temperature (°C)	At Recovery Temperature (°C)
Ambient	109.2	73.5
Input Capacitor (C2)	110.7	84.9
TNY288 (U1)	141.2	84.6
Transformer Core (T1)	114.2	85.5
Transformer Wire (T1)	116.0	85.3
Output Capacitor (C7)	107.2	85.5
Output Diode (D3)	130.6	84.6

12.4.2 OTP at 265 VAC

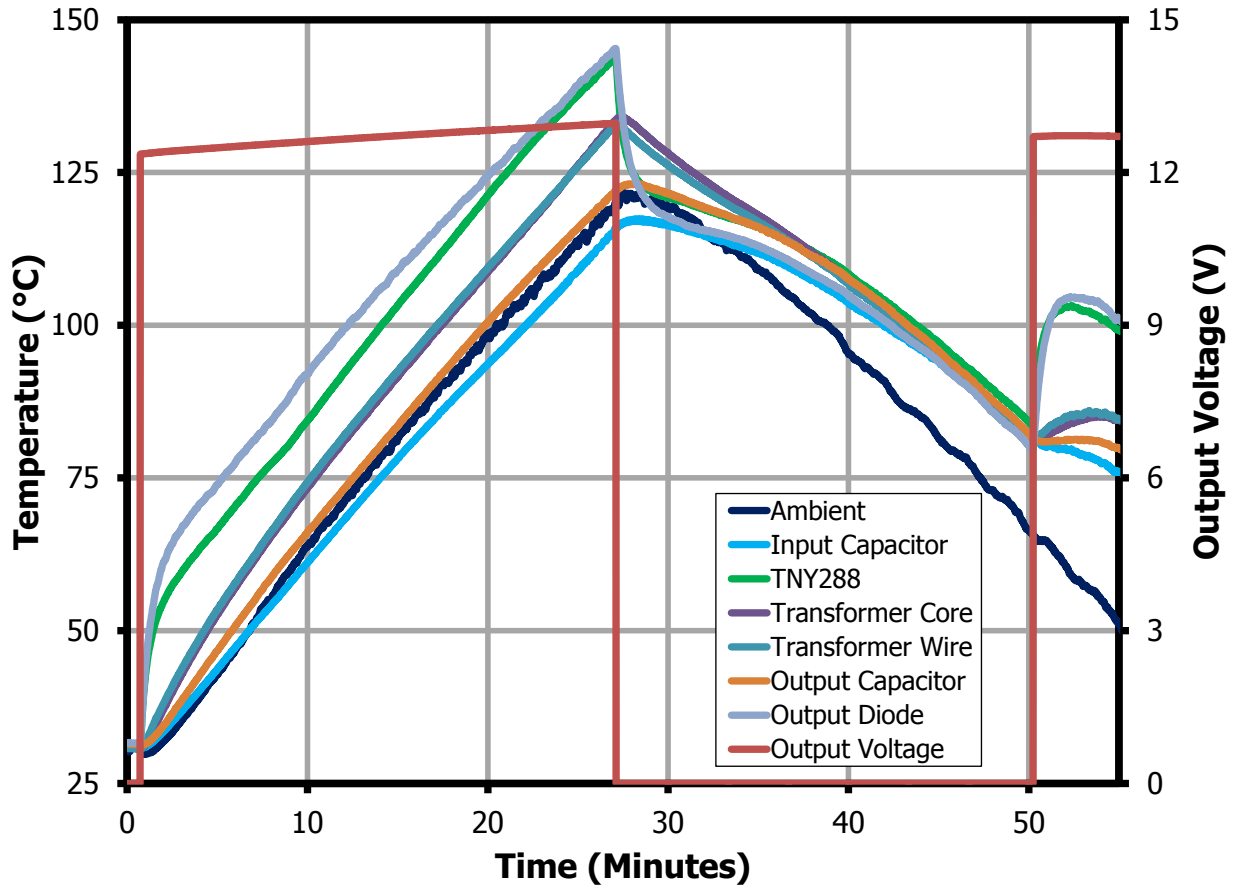

Figure 133 – Over Temperature Protection at 265 VAC using TNY288D.

Component	At OTP Trigger Temperature (°C)	At Recovery Temperature (°C)
Ambient	120.3	65.8
Input Capacitor (C2)	115.9	81.3
TNY288 (U1)	144.0	83.5
Transformer Core (T1)	133.6	81.4
Transformer Wire (T1)	133.0	81.2
Output Capacitor (C7)	122.1	81.7
Output Diode (D3)	145.3	79.5



13 Conducted EMI

Conducted emissions tests were performed at 115 VAC and 230 VAC at full load (12 V, 1 A). Measurements were taken with an Artificial Hand connected and a floating DC output load resistor. A DC output cable was included.

13.1 Test Set-up Equipment

13.1.1 Equipment and Load Used

1. Rohde and Schwarz ENV216 two line V-network.
2. Rohde and Schwarz ESRP EMI test receiver.
3. Hioki 3322 power Hi-tester.
4. Chroma measurement test fixture.
5. Input voltage set at 115 VAC and 230 VAC.

13.2 Test Set-up

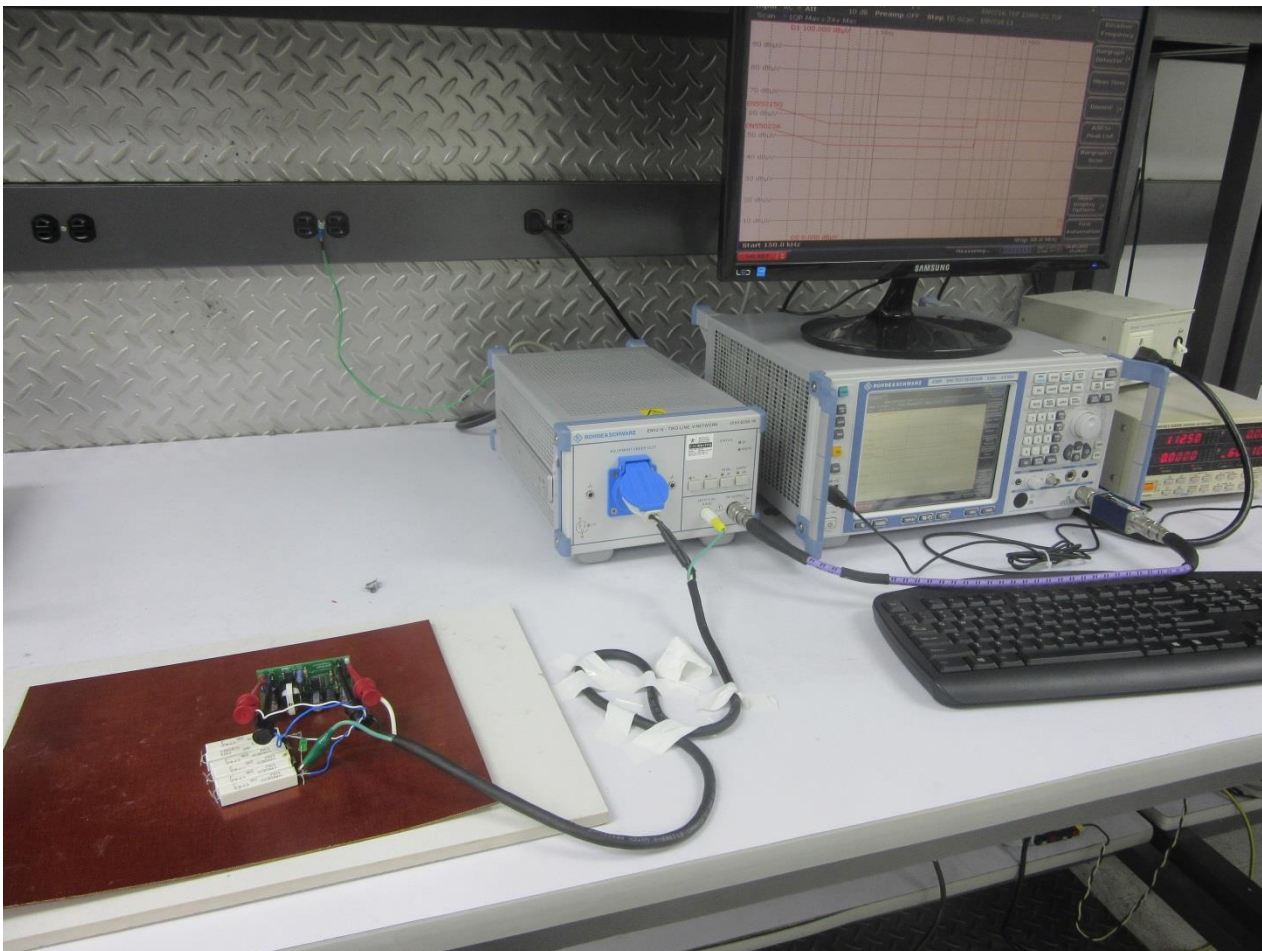

Figure 134 – EMI Test Set-up.

13.3 Test Results

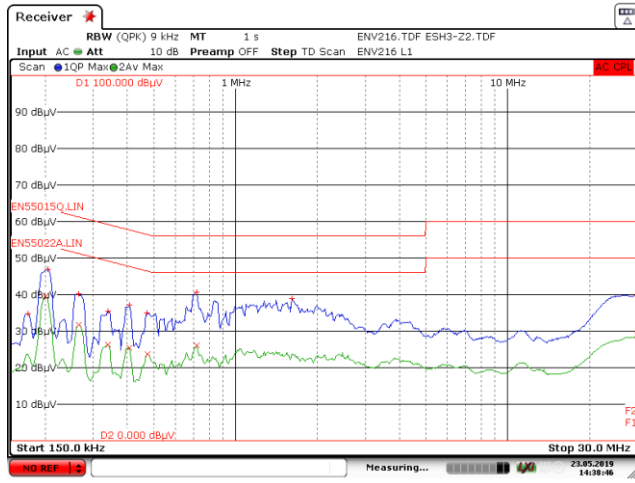

Figure 135 – 115 VAC 60 Hz, Line with Artificial Hand.

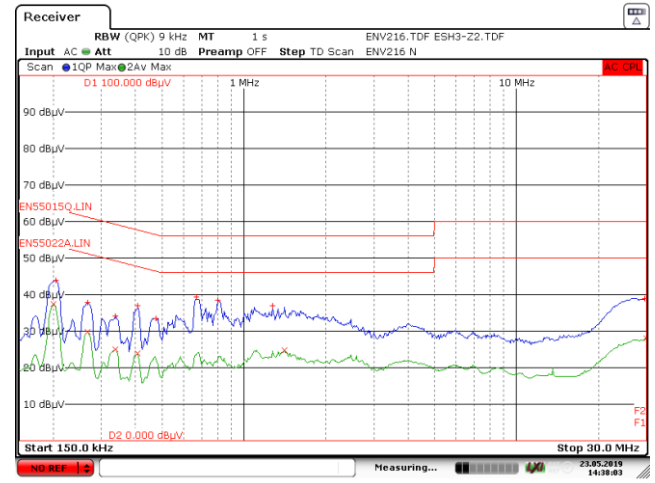

Figure 136 – 115 VAC 60 Hz, Neutral with Artificial Hand.

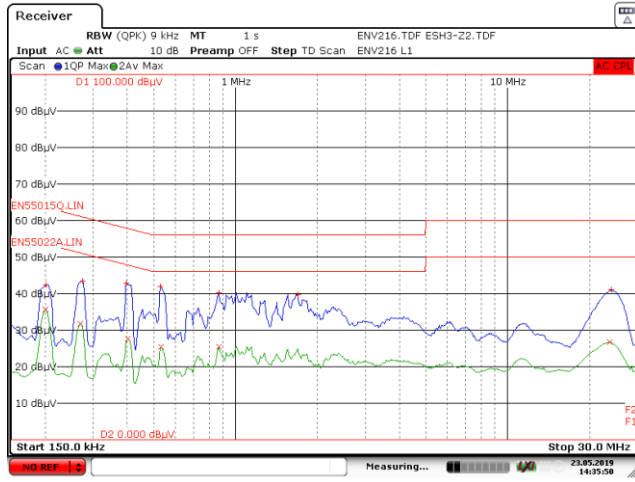

Figure 137 – 230 VAC 60 Hz, Line with Artificial Hand.

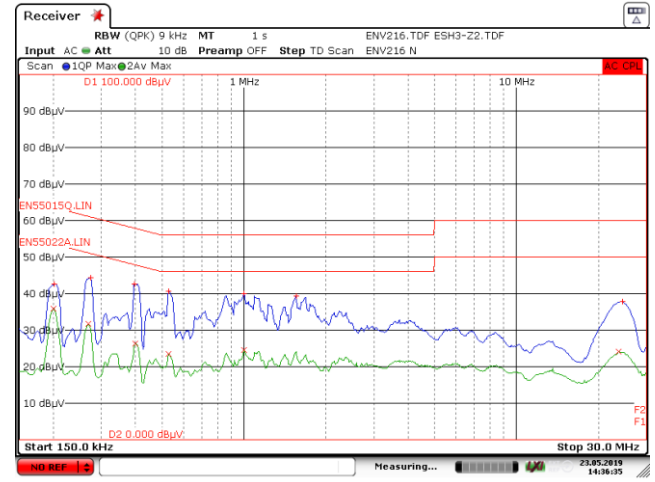

Figure 138 – 230 VAC 60 Hz, Neutral with Artificial Hand.



14 Line Surge

Differential and common mode input line surge testing was completed on a single test unit to IEC61000-4-5. Input voltage was set at 230 VAC / 60 Hz. Output was loaded at full load and operation was verified following each surge event.

14.1 Differential and Common Mode Surge

DM Surge Level (V)	Input Voltage (VAC)	Injection Location	Injection Phase (°)	Test Result (Pass/Fail)
+1000	230	L to N	0	Pass
-1000	230	L to N	0	Pass
+1000	230	L to N	90	Pass
-1000	230	L to N	90	Pass
+1000	230	L to N	180	Pass
-1000	230	L to N	180	Pass
+1000	230	L to N	270	Pass
-1000	230	L to N	270	Pass

CM Surge Level (V)	Input Voltage (VAC)	Injection Location	Injection Phase (°)	Test Result (Pass/Fail)
+2000	230	L, N to PE	0	Pass
-2000	230	L, N to PE	0	Pass
+2000	230	L, N to PE	90	Pass
-2000	230	L, N to PE	90	Pass
+2000	230	L, N to PE	180	Pass
-2000	230	L, N to PE	180	Pass
+2000	230	L, N to PE	270	Pass
-2000	230	L, N to PE	270	Pass

Note: In all PASS results, no damage and no auto-restart was observed.



Figure 139 – DM Surge.
 $V_{DS(MAX)} = 702 \text{ V}$.

Figure 140 – CM Surge.
 $V_{DS(MAX)} = 613 \text{ V}$

14.2 **Ring Wave**

Surge Level (V)	Input Voltage (VAC)	Injection Location	Injection Phase (°)	Test Result (Pass/Fail)
+3000	230	L, N to PE	0	Pass
-3000	230	L, N to PE	0	Pass
+3000	230	L, N to PE	90	Pass
-3000	230	L, N to PE	90	Pass
+3000	230	L, N to PE	180	Pass
-3000	230	L, N to PE	180	Pass
+3000	230	L, N to PE	270	Pass
-3000	230	L, N to PE	270	Pass

Note: In all PASS results, no damage and no auto-restart was observed.



14.3 **Electrical Fast Transient (EFT)**

Surge Level (V)	Injection Phase (°)	Frequency	T-Burst	T-Rep	Test Duration	Injection Location	Result (PASS,FAIL,AR)
+4000	0	2.5 kHz	30 ms	300 ms	120 s	L to N	Pass
-4000	0	2.5 kHz	30 ms	300 ms	120 s	L to N	Pass
+4000	0	5 kHz	15 ms	300 ms	120 s	L to N	Pass
-4000	0	5 kHz	15 ms	300 ms	120 s	L to N	Pass
+4000	0	100 kHz	750 μs	300 ms	120 s	L to N	Pass
-4000	0	100 kHz	750 μs	300 ms	120 s	L to N	Pass
+4000	90	2.5 kHz	30 ms	300 ms	120 s	L to N	Pass
-4000	90	2.5 kHz	30 ms	300 ms	120 s	L to N	Pass
+4000	90	5 kHz	15 ms	300 ms	120 s	L to N	Pass
-4000	90	5 kHz	15 ms	300 ms	120 s	L to N	Pass
+4000	90	100 kHz	750 μs	300 ms	120 s	L to N	Pass
-4000	90	100 kHz	750 μs	300 ms	120 s	L to N	Pass
+4000	270	2.5 kHz	30 ms	300 ms	120 s	L to N	Pass
-4000	270	2.5 kHz	30 ms	300 ms	120 s	L to N	Pass
+4000	270	5 kHz	15 ms	300 ms	120 s	L to N	Pass
-4000	270	5 kHz	15 ms	300 ms	120 s	L to N	Pass
+4000	270	100 kHz	750 μs	300 ms	120 s	L to N	Pass
-4000	270	100 kHz	750 μs	300 ms	120 s	L to N	Pass

Note: In all PASS results, no damage and no auto-restart was observed.

15 ESDPassed ± 8 kV contact discharge

Contact Voltage (kV)	Applied to	Number of Strikes	Test Result
+8	+12 V terminal	10	Pass
	RTN terminal	10	Pass
-8	+12 V terminal	10	Pass
	RTN terminal	10	Pass

Note: In all PASS results, no damage and no auto-restart was observed.Passed ± 15 KV Air discharge.

Air Discharge Voltage (kV)	Applied to	Number of Strikes	Test Result
+15	+12 V terminal	10	Pass
	RTN terminal	10	Pass
-15	+12 V terminal	10	Pass
	RTN terminal	10	Pass

Note: In all PASS results, no damage and no auto-restart was observed.

16 Revision History

Date	Author	Revision	Description and Changes	Reviewed
16-Jul-19	JPB	1.0	Initial Release.	Apps & Mktg
13-Aug-19	JPB	1.1	Added output short circuit (11.5.2) and overload (11.5.3)	Apps & Mktg
29-Jul-20	KM	1.2	Added Supplier for T1.	Apps & Mktg

For the latest updates, visit our website: www.power.com

Reference Designs are technical proposals concerning how to use Power Integrations' gate drivers in particular applications and/or with certain power modules. These proposals are "as is" and are not subject to any qualification process. The suitability, implementation and qualification are the sole responsibility of the end user. The statements, technical information and recommendations contained herein are believed to be accurate as of the date hereof. All parameters, numbers, values and other technical data included in the technical information were calculated and determined to our best knowledge in accordance with the relevant technical norms (if any). They may be based on assumptions or operational conditions that do not necessarily apply in general. We exclude any representation or warranty, express or implied, in relation to the accuracy or completeness of the statements, technical information and recommendations contained herein. No responsibility is accepted for the accuracy or sufficiency of any of the statements, technical information, recommendations or opinions communicated and any liability for any direct, indirect or consequential loss or damage suffered by any person arising therefrom is expressly disclaimed.

Power Integrations reserves the right to make changes to its products at any time to improve reliability or manufacturability. Power Integrations does not assume any liability arising from the use of any device or circuit described herein. POWER INTEGRATIONS MAKES NO WARRANTY HEREIN AND SPECIFICALLY DISCLAIMS ALL WARRANTIES INCLUDING, WITHOUT LIMITATION, THE IMPLIED WARRANTIES OF MERCHANTABILITY, FITNESS FOR A PARTICULAR PURPOSE, AND NON-INFRINGEMENT OF THIRD PARTY RIGHTS.

Patent Information

The products and applications illustrated herein (including transformer construction and circuits' external to the products) may be covered by one or more U.S. and foreign patents, or potentially by pending U.S. and foreign patent applications assigned to Power Integrations. A complete list of Power Integrations' patents may be found at www.power.com. Power Integrations grants its customers a license under certain patent rights as set forth at <http://www.power.com/ip.htm>.

Power Integrations, the Power Integrations logo, CAPZero, ChiPhy, CHY, DPA-Switch, EcoSmart, E-Shield, eSIP, eSOP, HiperPLC, HiperPFS, HiperTFS, InnoSwitch, Innovation in Power Conversion, InSOP, LinkSwitch, LinkZero, LYTSwitch, SENZero, TinySwitch, TOPSwitch, PI, PI Expert, SCALE, SCALE-1, SCALE-2, SCALE-3 and SCALE-iDriver, are trademarks of Power Integrations, Inc. Other trademarks are property of their respective companies. ©2019, Power Integrations, Inc.

Power Integrations Worldwide Sales Support Locations

WORLD HEADQUARTERS

5245 Hellyer Avenue
San Jose, CA 95138, USA.
Main: +1-408-414-9200
Customer Service:
Worldwide: +1-65-635-64480
Americas: +1-408-414-9621
e-mail: usasales@power.com

CHINA (SHANGHAI)

Rm 2410, Charity Plaza, No. 88,
North Caoxi Road,
Shanghai, PRC 200030
Phone: +86-21-6354-6323
e-mail: chinasales@power.com

CHINA (SHENZHEN)

17/F, Hivac Building, No. 2, Keji
Nan 8th Road, Nanshan District,
Shenzhen, China, 518057
Phone: +86-755-8672-8689
e-mail: chinasales@power.com

GERMANY (AC-DC/LED Sales)

Einsteinring 24
85609 Dornach/Aschheim
Germany
Tel: +49-89-5527-39100
e-mail: eurosales@power.com

GERMANY (Gate Driver Sales)

HellwegForum 1
59469 Ense
Germany
Tel: +49-2938-64-39990
e-mail: igbt-driver.sales@power.com

INDIA

#1, 14th Main Road
Vasanthanagar
Bangalore-560052
India
Phone: +91-80-4113-8020
e-mail: indiasales@power.com

ITALY

Via Milanese 20, 3rd. Fl.
20099 Sesto San Giovanni (MI) Italy
Phone: +39-024-550-8701
e-mail: eurosales@power.com

JAPAN

Yusen Shin-Yokohama 1-chome Bldg.
1-7-9, Shin-Yokohama, Kohoku-ku
Yokohama-shi,
Kanagawa 222-0033 Japan
Phone: +81-45-471-1021
e-mail: japansales@power.com

KOREA

RM 602, 6FL
Korea City Air Terminal B/D,
159-6
Samsung-Dong, Kangnam-Gu,
Seoul, 135-728 Korea
Phone: +82-2-2016-6610
e-mail: koreasales@power.com

SINGAPORE

51 Newton Road,
#19-01/05 Goldhill Plaza
Singapore, 308900
Phone: +65-6358-2160
e-mail: singaporesales@power.com

TAIWAN

5F, No. 318, Nei Hu Rd.,
Sec. 1
Nei Hu District
Taipei 11493, Taiwan R.O.C.
Phone: +886-2-2659-4570
e-mail: taiwansales@power.com

UK

Building 5, Suite 21
The Westbrook Centre
Milton Road
Cambridge
CB4 1YG
Phone: +44 (0) 7823-557484
e-mail: eurosales@power.com

