

Trench gate field-stop 1350 V, 35 A, soft-switching IH2 series IGBT in a TO-247 long leads package

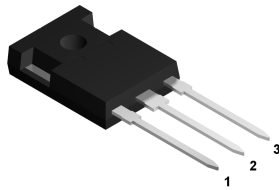

TO-247 long leads

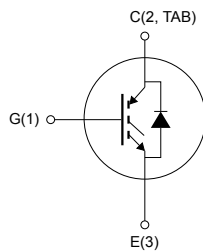

NG1E3C2T

Features

- Designed for soft-commutation
- Maximum junction temperature: $T_J = 175\text{ °C}$
- $V_{CE(sat)} = 1.7\text{ V}$ (typ.) at $I_C = 30\text{ A}$
- Minimized tail current
- Tight parameter distribution
- Low thermal resistance
- Very low drop and soft recovery co-packaged diode
- Positive $V_{CE(sat)}$ temperature coefficient

Applications

- Induction heating
- Resonant converters
- Microwave ovens

Description

The newest IGBT 1350 V IH2 series has been developed using an advanced proprietary trench gate field-stop structure, whose performance is optimized both in conduction and switching losses for soft commutation. A freewheeling diode with a low drop forward voltage is included. The result is a product specifically designed to maximize efficiency for any resonant and soft-switching applications.



Product status link

[STGWA35IH135DF2](#)

Product summary

Order code	STGWA35IH135DF2
Marking	G35IH135DF2
Package	TO-247 long leads
Packing	Tube

1 Electrical ratings

Table 1. Absolute maximum ratings

Symbol	Parameter	Value	Unit
V_{CES}	Collector-emitter voltage ($V_{GE} = 0\text{ V}$)	1350	V
I_C	Continuous collector current at $T_C = 25\text{ °C}$	70	A
	Continuous collector current at $T_C = 100\text{ °C}$	35	
$I_{CP}^{(1)}$	Pulsed collector current	140	A
V_{GE}	Gate-emitter voltage	± 20	V
I_F	Continuous forward current at $T_C = 25\text{ °C}$	43 ⁽²⁾	A
	Continuous forward current at $T_C = 100\text{ °C}$	35	
$I_{FP}^{(1)}$	Pulsed forward current	140	A
P_{TOT}	Total power dissipation at $T_C = 25\text{ °C}$	416	W
T_{STG}	Storage temperature range	- 55 to 150	°C
T_J	Operating junction temperature range	- 55 to 175	

1. Pulse width limited by maximum junction temperature.
2. Current level is limited by bond wires.

Table 2. Thermal data

Symbol	Parameter	Value	Unit
R_{thJC}	Thermal resistance, junction-to-case, IGBT	0.36	°C/W
	Thermal resistance, junction-to-case, diode	0.97	
R_{thJA}	Thermal resistance, junction-to-ambient	50	°C/W

2 Electrical characteristics

$T_C = 25\text{ °C}$ unless otherwise specified

Table 3. Static characteristics

Symbol	Parameter	Test conditions	Min.	Typ.	Max.	Unit
$V_{(BR)CES}$	Collector-emitter breakdown voltage	$V_{GE} = 0\text{ V}, I_C = 1\text{ mA}$	1350			V
$V_{CE(sat)}$	Collector-emitter saturation voltage	$V_{GE} = 15\text{ V}, I_C = 30\text{ A}$		1.7	2.2	V
		$V_{GE} = 15\text{ V}, I_C = 30\text{ A}, T_J = 125\text{ °C}$		1.9		
		$V_{GE} = 15\text{ V}, I_C = 30\text{ A}, T_J = 175\text{ °C}$		2		
V_F	Forward on-voltage	$I_F = 30\text{ A}$		1.25		V
		$I_F = 30\text{ A}, T_J = 125\text{ °C}$		1.3		
		$I_F = 30\text{ A}, T_J = 175\text{ °C}$		1.3		
$V_{GE(th)}$	Gate threshold voltage	$V_{CE} = V_{GE}, I_C = 1\text{ mA}$	5	6	7	V
I_{CES}	Collector cut-off current	$V_{GE} = 0\text{ V}, V_{CE} = 1350\text{ V}$			25	μA
I_{GES}	Gate-emitter leakage current	$V_{CE} = 0\text{ V}, V_{GE} = \pm 20\text{ V}$			± 250	nA

Table 4. Dynamic characteristics

Symbol	Parameter	Test conditions	Min.	Typ.	Max.	Unit
C_{ies}	Input capacitance	$V_{CE} = 25\text{ V}, f = 1\text{ MHz}, V_{GE} = 0\text{ V}$	-	2920	-	pF
C_{oes}	Output capacitance		-	124	-	pF
C_{res}	Reverse transfer capacitance		-	69	-	pF
Q_g	Total gate charge	$V_{CC} = 1080\text{ V}, I_C = 30\text{ A}, V_{GE} = 0\text{ to }15\text{ V}$ (see Figure 25. Gate charge test circuit)	-	258	-	nC
Q_{ge}	Gate-emitter charge		-	22	-	nC
Q_{gc}	Gate-collector charge		-	147	-	nC

Table 5. IGBT switching characteristics (inductive load)

Symbol	Parameter	Test conditions	Min.	Typ.	Max.	Unit
$t_{d(off)}$	Turn-off delay time	$V_{CC} = 600\text{ V}, I_C = 30\text{ A},$	-	368	-	ns
t_f	Current fall time	$V_{GE} = 15\text{ V}, R_G = 10\ \Omega$	-	121	-	ns
$E_{off}^{(1)}$	Turn-off switching energy	(see Figure 23. Test circuit for inductive load switching)	-	1.6	-	mJ
$t_{d(off)}$	Turn-off delay time	$V_{CC} = 600\text{ V}, I_C = 30\text{ A},$	-	407	-	ns
t_f	Current fall time	$V_{GE} = 15\text{ V}, R_G = 10\ \Omega, T_J = 175\text{ °C}$	-	281	-	ns
$E_{off}^{(1)}$	Turn-off switching energy	(see Figure 23. Test circuit for inductive load switching)	-	2.68	-	mJ

1. Including the tail of the collector current.

Table 6. IGBT switching characteristics (capacitive load)

Symbol	Parameter	Test conditions	Min.	Typ.	Max.	Unit
$E_{off}^{(1)}$	Turn-off switching energy	$V_{CC} = 900\text{ V}$, $V_{GE} = 15\text{ V}$, $R_G = 10\ \Omega$, $I_C = 60\text{ A}$, $L = 500\ \mu\text{H}$, $C_{sn} = 330\text{ nF}$ (see Figure 24. Test circuit for snubbed inductive load switching)	-	588	-	μJ
		$V_{CC} = 900\text{ V}$, $V_{GE} = 15\text{ V}$, $R_G = 10\ \Omega$, $I_C = 60\text{ A}$, $L = 500\ \mu\text{H}$, $C_{sn} = 330\text{ nF}$, $T_J = 175\text{ }^\circ\text{C}$ (see Figure 24. Test circuit for snubbed inductive load switching)	-	1030	-	

1. Including the tail of the collector current.

2.1 Electrical characteristics (curves)

Figure 1. Total power dissipation vs temperature

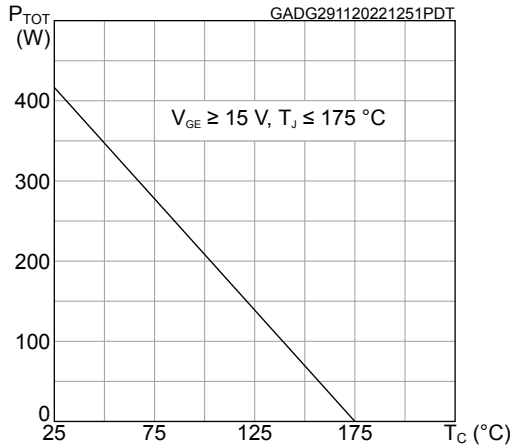

Figure 2. Collector current vs temperature

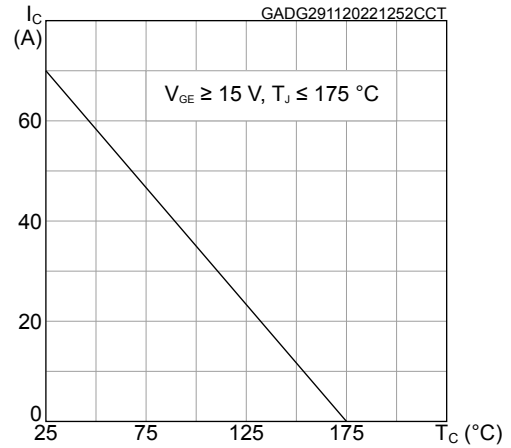

Figure 3. Typical output characteristics (T_J = 25 °C)

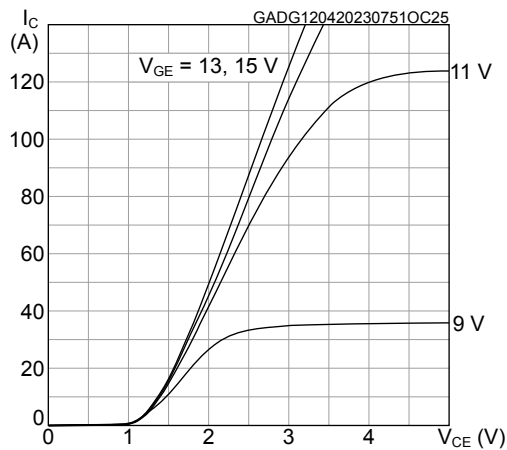

Figure 4. Typical output characteristics (T_J = 175 °C)

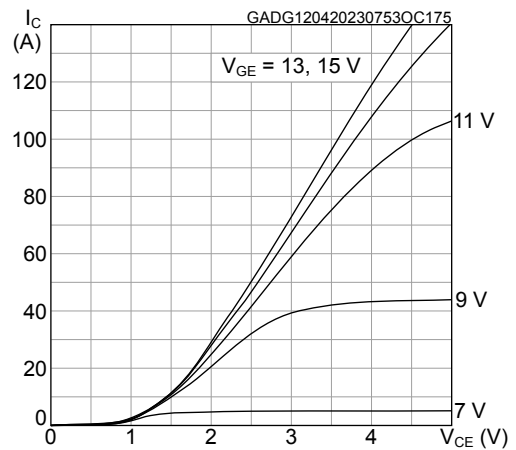

Figure 5. Typical V_{CE(sat)} vs temperature

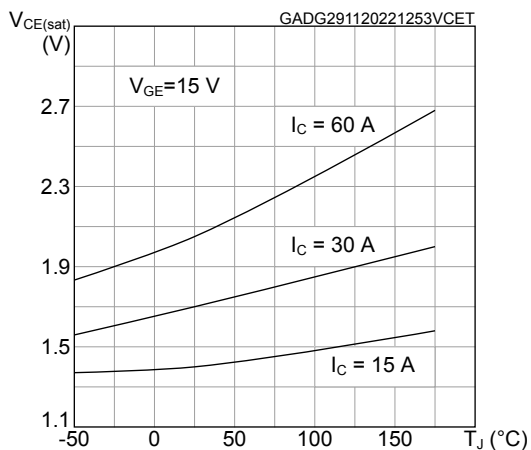

Figure 6. Typical V_{CE(sat)} vs collector current

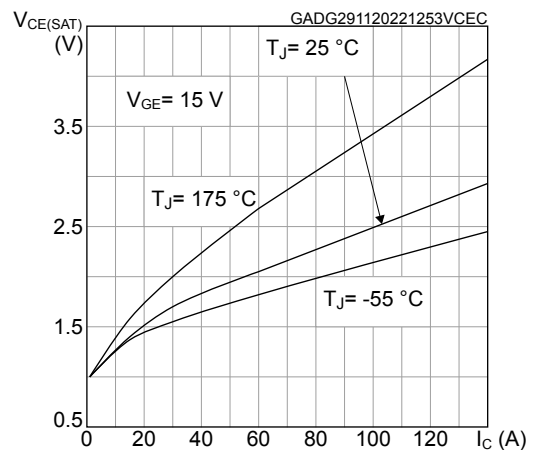

Figure 7. Forward bias safe operating area

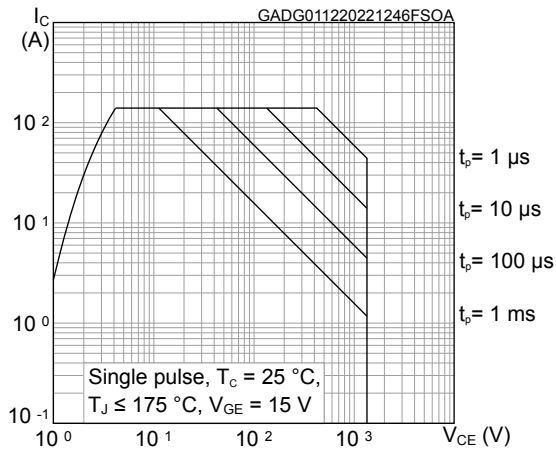

Figure 8. Transfer characteristics

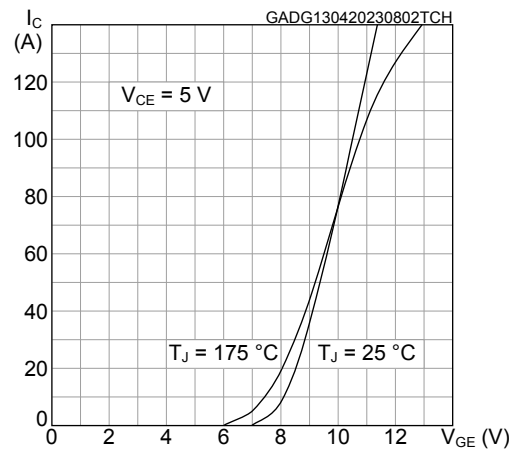

Figure 9. Typical diode V_F vs forward current

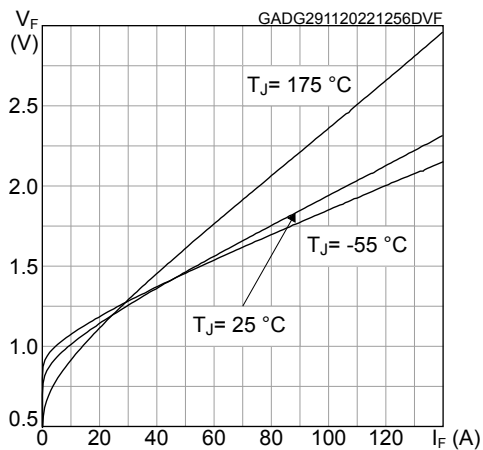

Figure 10. Normalized V_GE(th) vs temperature

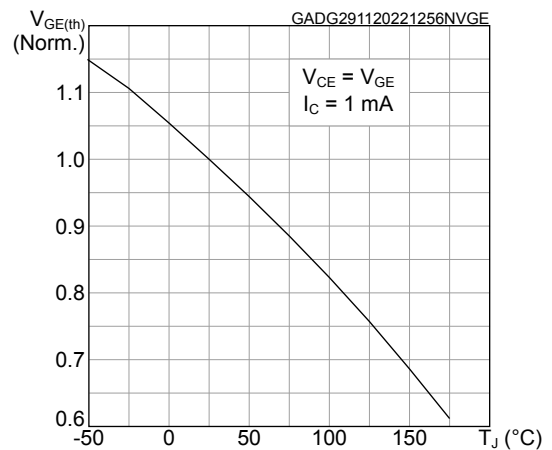

Figure 11. Normalized V_(BR)CES vs temperature

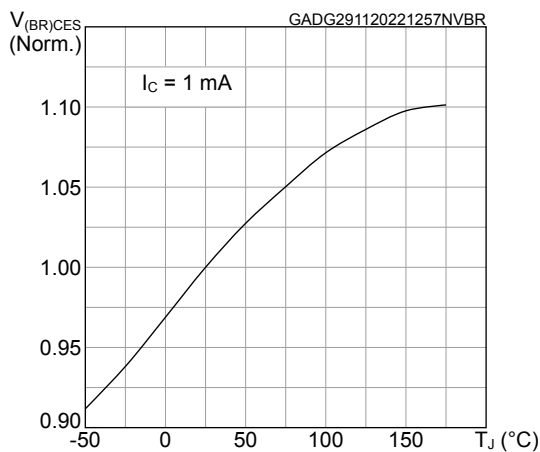

Figure 12. Typical capacitance characteristics

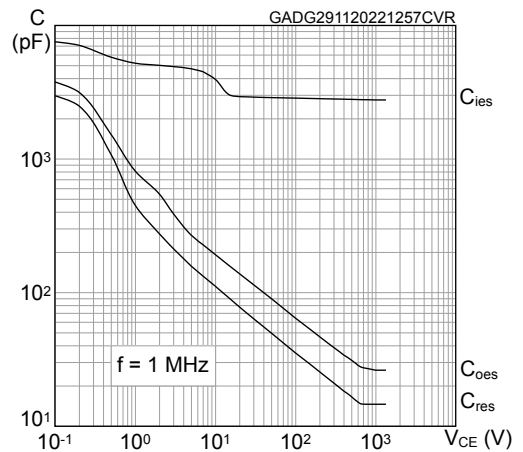

Figure 13. Typical gate charge characteristics

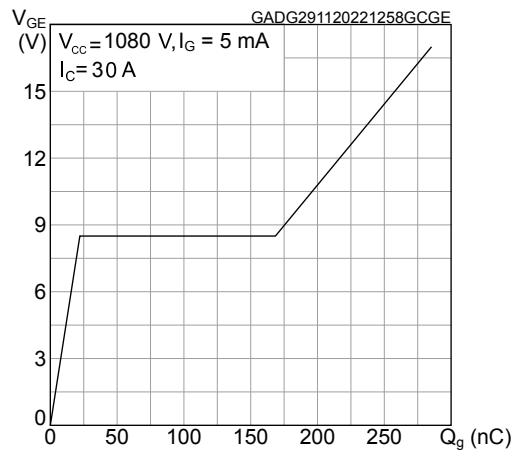

Figure 14. Typical switching energy vs collector current

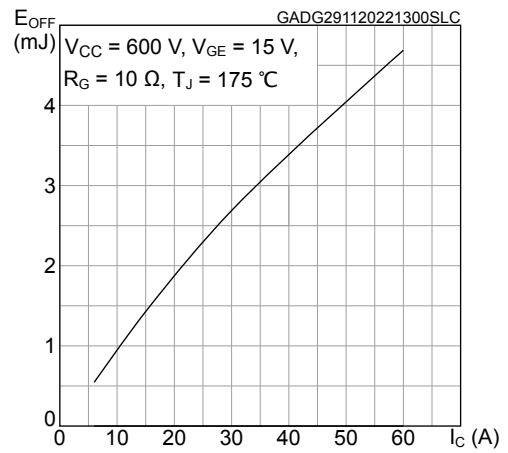

Figure 15. Typical switching energy vs temperature

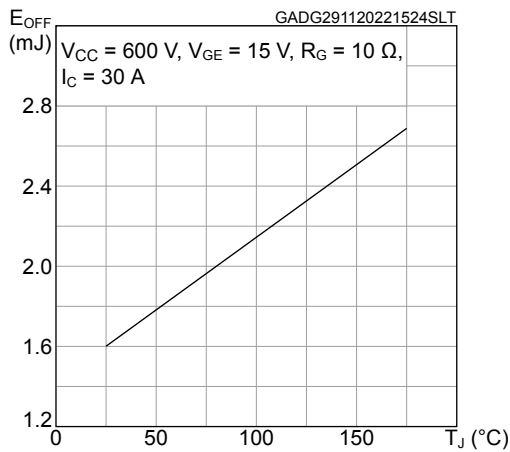

Figure 16. Typical switching energy vs collector emitter voltage

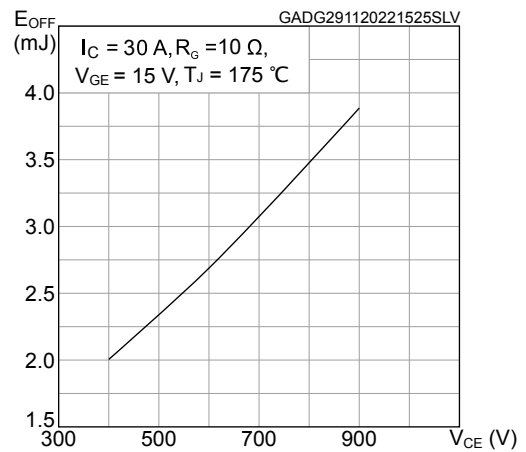

Figure 17. Typical switching energy vs RG

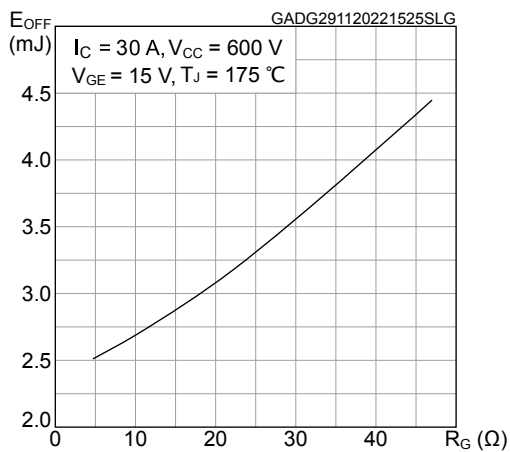

Figure 18. Typical switching times vs collector current

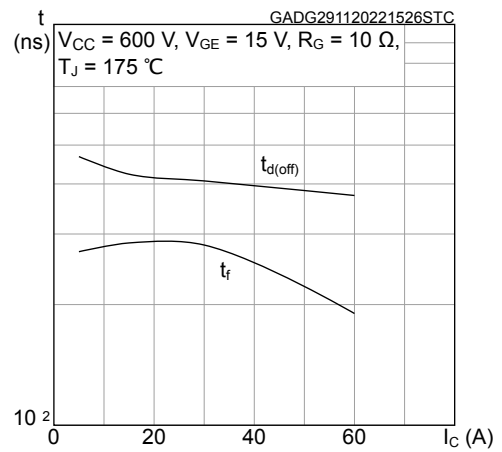

Figure 19. Typical switching times vs gate resistance

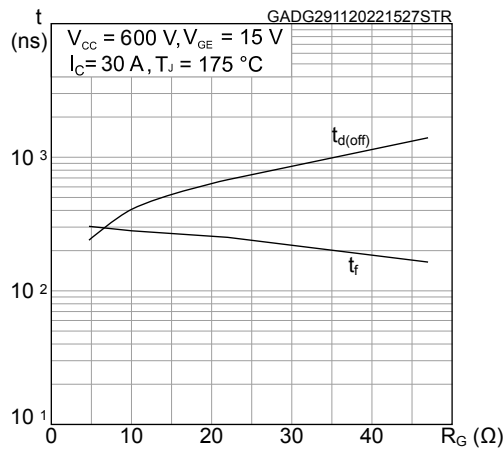

Figure 20. Typical switching energy vs snubber capacitance

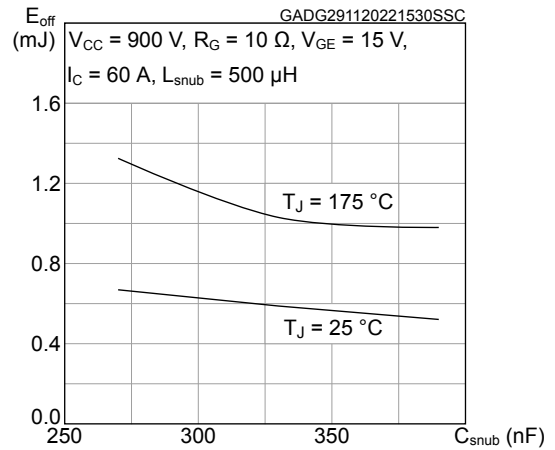

Figure 21. Maximum transient thermal impedance for IGBT

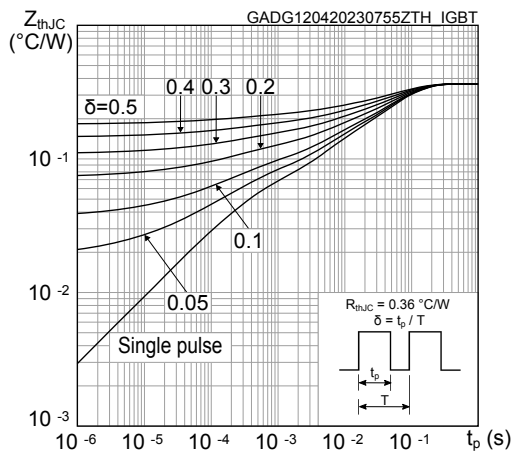
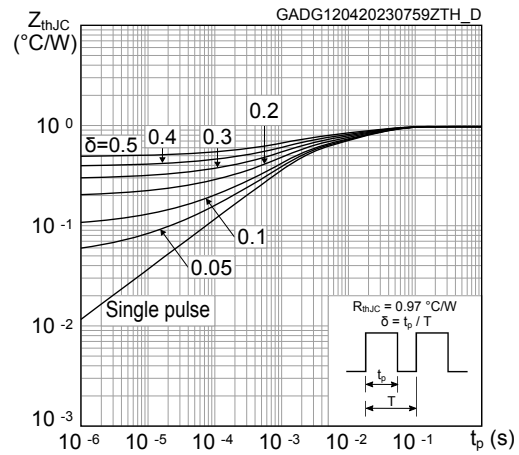
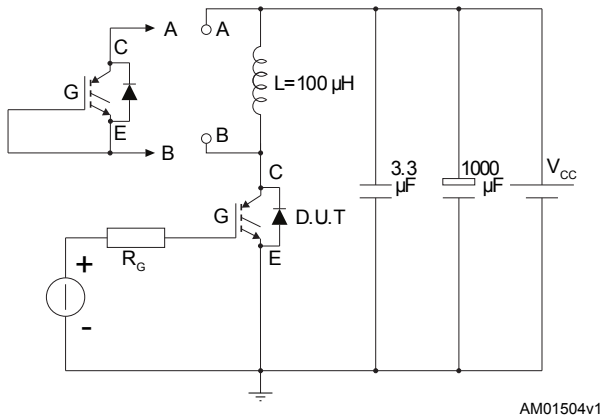
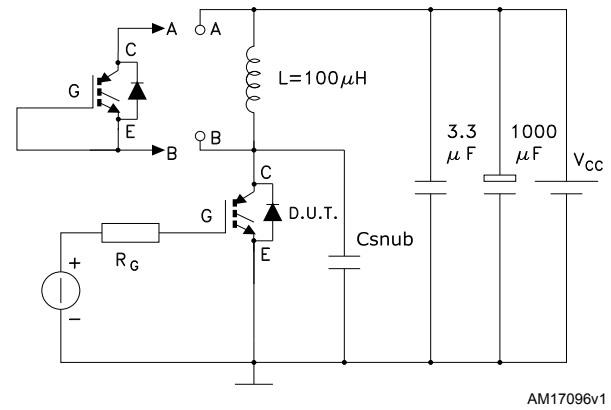
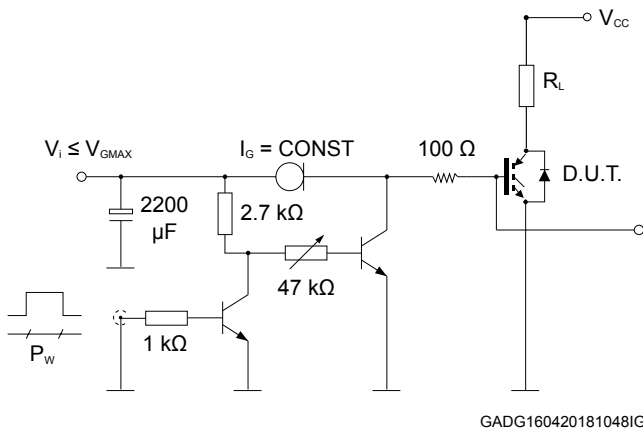
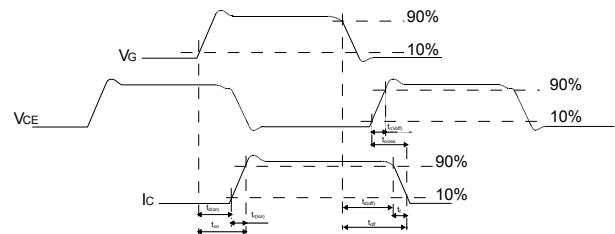

Figure 22. Maximum transient thermal impedance for diode



3 Test circuits

Figure 23. Test circuit for inductive load switching

Figure 24. Test circuit for snubbed inductive load switching

Figure 25. Gate charge test circuit

Figure 26. Switching waveform

4 Package information

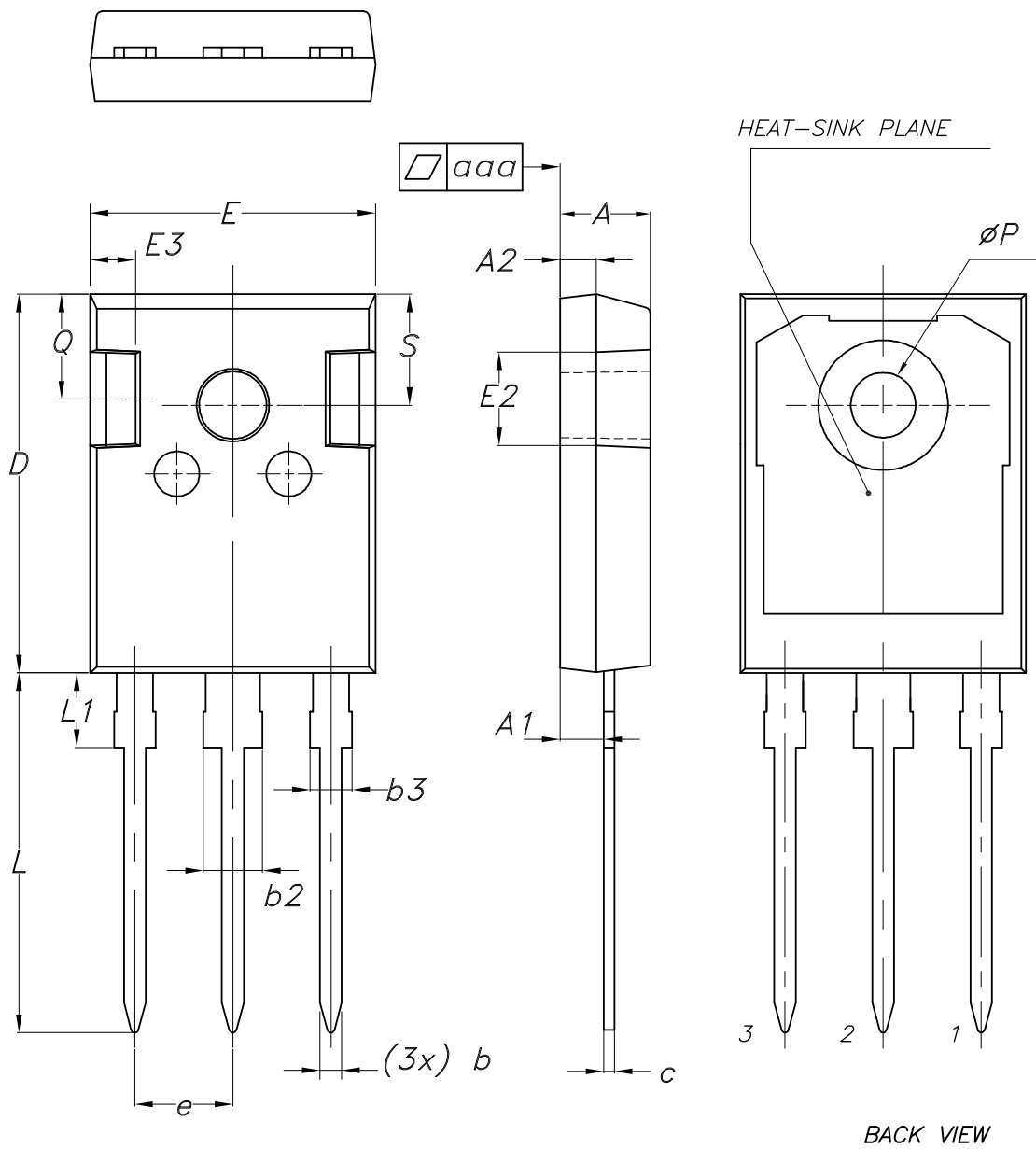
In order to meet environmental requirements, ST offers these devices in different grades of **ECOPACK** packages, depending on their level of environmental compliance. ECOPACK specifications, grade definitions and product status are available at: www.st.com. ECOPACK is an ST trademark.

4.1 TO-247 long leads package information

Figure 27. TO-247 long leads package outline



8463846_4

Table 7. TO-247 long leads package mechanical data

Dim.	mm		
	Min.	Typ.	Max.
A	4.90	5.00	5.10
A1	2.31	2.41	2.51
A2	1.90	2.00	2.10
b	1.16		1.26
b2			3.25
b3			2.25
c	0.59		0.66
D	20.90	21.00	21.10
E	15.70	15.80	15.90
E2	4.90	5.00	5.10
E3	2.40	2.50	2.60
e	5.34	5.44	5.54
L	19.80	19.92	20.10
L1			4.30
P	3.50	3.60	3.70
Q	5.60		6.00
S	6.05	6.15	6.25
aaa		0.04	0.10

Revision history

Table 8. Document revision history

Date	Revision	Changes
06-Dec-2022	1	First release.
15-Feb-2023	2	Updated <i>Table 1. Absolute maximum ratings.</i> Updated <i>Table 2. Thermal data.</i> Updated <i>Figure 14. Typical switching energy vs collector current, Figure 15. Typical switching energy vs temperature, Figure 16. Typical switching energy vs collector emitter voltage and Figure 17. Typical switching energy vs R_G.</i>
13-Apr-2023	3	Updated <i>Figure 3. Typical output characteristics ($T_J = 25\text{ °C}$), Figure 4. Typical output characteristics ($T_J = 175\text{ °C}$), Figure 8. Transfer characteristics, Figure 21. Maximum transient thermal impedance for IGBT and Figure 22. Maximum transient thermal impedance for diode.</i> Minor text changes.

Contents

1	Electrical ratings	2
2	Electrical characteristics	3
2.1	Electrical characteristics (curves)	5
3	Test circuits	9
4	Package information	10
4.1	TO-247 long leads package information	10
	Revision history	12

IMPORTANT NOTICE – READ CAREFULLY

STMicroelectronics NV and its subsidiaries (“ST”) reserve the right to make changes, corrections, enhancements, modifications, and improvements to ST products and/or to this document at any time without notice. Purchasers should obtain the latest relevant information on ST products before placing orders. ST products are sold pursuant to ST’s terms and conditions of sale in place at the time of order acknowledgment.

Purchasers are solely responsible for the choice, selection, and use of ST products and ST assumes no liability for application assistance or the design of purchasers’ products.

No license, express or implied, to any intellectual property right is granted by ST herein.

Resale of ST products with provisions different from the information set forth herein shall void any warranty granted by ST for such product.

ST and the ST logo are trademarks of ST. For additional information about ST trademarks, refer to www.st.com/trademarks. All other product or service names are the property of their respective owners.

Information in this document supersedes and replaces information previously supplied in any prior versions of this document.

© 2023 STMicroelectronics – All rights reserved