

EXTREME SPEC Pak™

Sealed Power For Environmental Connections



Marine | Wind Power | Lighting | Transportation | Pumps | Ground Support
Machine Tool | Industrial Automation | Motor | Solar Power | Harsh Environments



APP
Anderson Power Products

Rugged and Sealed (IP68) Plugs and Receptacles

For Use with APP® Powerpole® Signal, Power & Ground Contacts & Housings

The SPEC Pak™ Extreme uses rugged and environmentally sealed (IP68) shells to protect APP Powerpole® contacts and housings. Customer configured SPEC Pak™ Extreme Connectors are capable of up to 320 amps and may be used anywhere a rugged and/or waterproof high power, signal and ground interconnect solution is required.

The SPEC Pak™ Extreme shell accepts 75 to 180 amp Powerpole® contacts. The wide range of Powerpole® housing colors and contact sizes, coupled with the available Powerpole® holders, offers the user a wide array of design options. Flexibility can be enhanced by replacing a PP120 housing with the PP 15/45 adapter to provide auxiliary signal options. Wire sizes ranging from 20 to 3/0 AWG (0.5 to 85.0 mm²) can be accommodated. SPEC Pak™ Extreme is highly configurable with thousands of design options in a single interconnect.

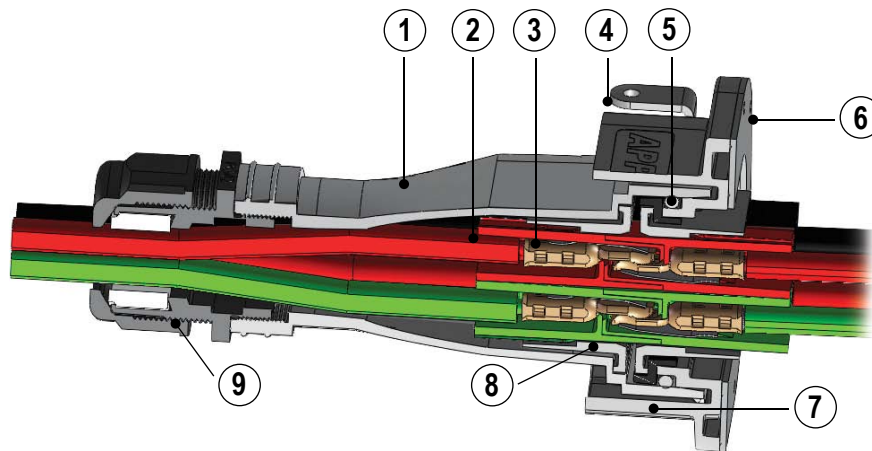

8 Powerpole® Insert Holders



E02



E04



E06



E09

- 1 - Chemical & UV Resistant Ruggedized Plug Shell
- 2 - Color Coded Powerpole® Housings Match Wire Colors
- 3 - Power Contacts (up to 310 amps)
- 4 - Stainless Steel Latches (securing plug to receptacle)
- 5 - IP68 Interfacial Sealing O-Ring
- 6 - IP68 Panel Mount Sealing Gasket
- 7 - Chemical & UV Resistant Ruggedized Panel Mount Receptacle Shell

8 - Powerpole® Insert Holders (user configurable)

- E02 Arrangement - up to two PP180
- E04 Arrangement - up to four PP120
- E06 Arrangement - up to six PP120 (4) & PP75 (2)
- E09 Arrangement - up to nine PP75

9 - Industry Standard Sealing (IP68) Components

- PG Gland Compatible - Size 42
- Multi-hole Glands For Use With Discrete Wires
- Single Hole Glands For Use With Jacketed Cable

Specifications

Extreme SPEC Pak™ Shell / Components

Electrical	Extreme
UL Voltage Rating (AC/DC)	600
Dielectric Withstanding Voltage (AC)	3000
Operating Temperature (°C)	-20 to + 105
(°F)	-4 to 221
Flammability Rating of SPEC Pak™ Shells	UL94 V-0
UV Rating (equivalent)	UL746C F1

Mechanical	
Shell/Latch Mating Cycles	1,500
Average Connect/Disconnect (lbf)	37
(N)	165
IP Rating	IP68
Sealing Exceeds IP68, Meets Sealing Requirements of UL50E	
Crush Test per EIA-364-40B	Pass

Material	
SPEC Pak™ - Receptacle, Plug & Holders	PBT
Latch	Stainless Steel
Latch Retainer	Stainless Steel
Holder Retention Hardware (M8 x 18 & M8 x 25 screws)	NI Plated Steel

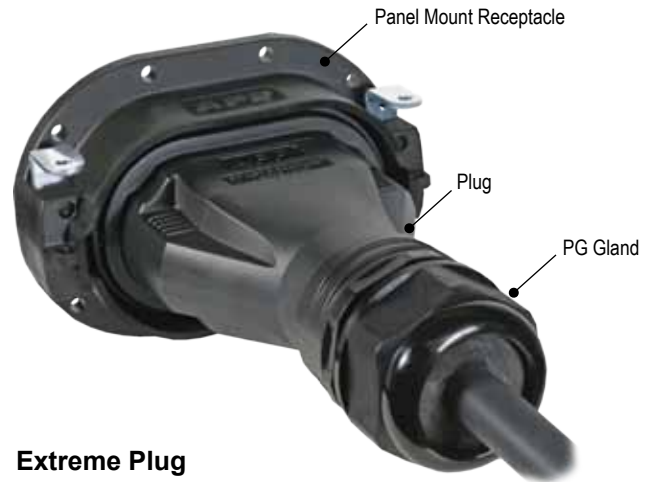

**Extreme Plug
Mated To Panel Mount Receptacle**

Powerpole® Contacts	PP180	PP120	PP75	PP15/45 & Ground
UL Current Rating (Amperes)	310	200	75	15 to 45
CSA (30C Rise) (Amperes)	230	155	45	10 to 29
Voltage Rating (AC/DC)	600	600	600	600
Contact Barrel Wire Size (AWG) - Power	3/0 to 6	1/0 to 6	6 to 12	10 to 20
- Ground	-	-	-	10 to 14
(mm²) - Power	85 to 13.3	53.5 to 13.3	13.3 to 3.3	4.0 to 0.5
- Ground	-	-	-	4.0 to 1.5
Average Contact Resistance (micro-ohms)	100	136	200	600
Contact Retention Force (lbf)	170	100	50	25-35
(N)	756	445	222	111
Operating Temperature (°C)	-20 to 105	-20 to 105	-20 to 105	-20 to 105
(°F)	-4 to 221	-4 to 221	-4 to 221	40 to 221
Flammability Rating	UL94 V-0	UL94 V-0	UL94 V-0	UL94 V-0
Contact Materials	Copper	Copper	Copper	Copper
Contact Plating	Silver	Silver	Silver	Tin or Silver
Mechanical				
Mating Cycles - No Load	10,000	10,000	10,000	10,000
Average Connect/Disconnect (lbf)	20	8	5 (Low Detent)	3 (Low Detent)
(single mated pair)			7 (High Detent)	5 (High Detent)
Material				
Powerpole® Housing Material	Polycarbonate	Polycarbonate	Polycarbonate	Polycarbonate

NOTE: Agency approvals - TUV Pending **UL** File No. E26226
/ Patents & Patents Pending



Part Number Configurator

PART NUMBER PLAN

SPEC Pak™ Series (1 Fixed Character) Shell Color (1 Character) Shell Style (1 Character) Dash Shell Size (mm) (3 Characters) Insert Arrangement (3 Characters)

S **K** **2** **-** **142** **E02**

S = SPEC Pak™ Series

K = Black

2 = Panel Mount Receptacle
6 = Straight Plug
9P = Environmental Plug Cover

142 = 142mm shell

Detailed Information
Is Available On:

E02 = PP180, 2 Pole Page 7
E04 = PP120 Housing, 4 Pole Page 8
E06 = PP120 (4), PP75 (2), 6 Pole ... Page 9
E09 = PP75, 9 Pole Page 10

PLUG KIT

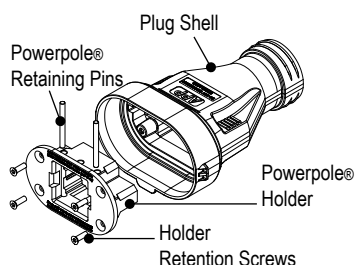

NOTE:

- Panel mount receptacle mounting hardware (8 each ¼ inch or M6 screw) not included
- Recommended torque for panel mount receptacle mounting hardware is 26 to 30 inch - lbs [3 to- 3.4Nm]

RECEPTACLE KIT

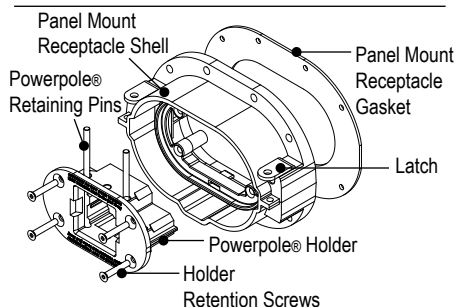

PLUG COVER

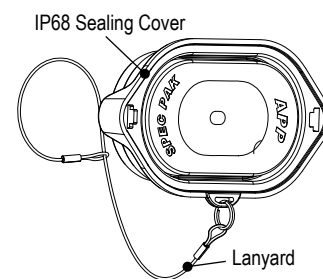

ORDERING INFORMATION

SPEC Pak™ Kits

Part Number	Description
SK2-142E02	Receptacle Kit - Panel mount shell with latches - Panel mount gasket - Powerpole® holder - 2 pole - Retaining pins - 0.187 x 1.5 - Holder retention screws - M5 x 25
SK2-142E04	Receptacle Kit - Panel mount shell with latches - Panel mount gasket - Powerpole® holder - 4 pole - Retaining pins - 0.187 x 2.0 - Holder retention screws - M5 x 25
SK2-142E06	Receptacle Kit - Panel mount shell with latches - Panel mount gasket - Powerpole® holder - 6 pole - Retaining pins - 0.187 x 2.0 - Retaining pins - 0.187 x 0.87 - Holder retention screws - M5 x 25
SK2-142E09	Receptacle Kit - Panel mount shell with latches - Panel mount gasket - Powerpole® holder - 9 pole - Holder Retention Screws - M5 x 25

Part Number	Description
SK6-142E02	Plug Kit - Plug shell - Powerpole® holder - 2 pole - Retaining pins - 0.187 x 1.5 - Holder retention screws - M5 x 18
SK6-142E04	Plug Kit - Plug shell - Powerpole® holder - 4 pole - Retaining pins - 0.187 x 2.0 - Holder retention screws - M5 x 18
SK6-142E06	Plug Kit - Plug shell - Powerpole® holder - 6 pole - Retaining pins - Retaining pins - 0.187 x 2.0 - Retaining pins - 0.187 x 0.87 - Holder retention screws - M5 x 18
SK6-142E09	Plug Kit - Plug Shell - Powerpole® holder - 9 pole - Holder retention screws - M5 x 18

Component Replacement Parts

Part Number	Description
H1120P49	Screw M5x25 (for use in w/ receptacle)
H1120P48	Screw M5x18 (for use in w/ plug)
111812P12	Retaining pin 0.187 x 2.0
111812P11	Retaining pin 0.187 x 0.87
111812P1	Retaining pin 0.094 x 0.85
114896P1	Panel gasket (for use w/ receptacle)
111812P8	Retaining pin 0.187 x 1.5
2400G1	PP15/45 housing adapter

Cover Kit

Part Number	Description
SK9P-142	Plug Protective Cover - Protective sealing (IP68) cover - Lanyard

NOTE: Contact factory for receptacle cover.

PART NUMBER PLAN

Wire Protection See page 6 (4 Characters)	Housing Arrangement For more information see pages 7 thru 10 Dash (1 Character)	Contact For more information see pages 7 thru 10 Dash (2 Characters)	APP® Content Dash (3 Characters)																																																																																				
PS	00	-	0																																																																																				
00	00	-	A01																																																																																				
00 = None PS = Plastic Short PM = Plastic Multi-hole	00 = None 00 - 99 = Various Gland Type <table border="1" style="width: 100%; border-collapse: collapse;"> <thead> <tr> <th style="text-align: left;">Housing Arrangement</th> <th style="text-align: left;">Available in Insert Arrangement</th> </tr> </thead> <tbody> <tr><td>0 = Custom Configuration</td><td>-</td></tr> <tr><td>A = AC Single Phase</td><td>E04</td></tr> <tr><td>B = AC 3 Phase, 3 Wire</td><td>E04</td></tr> <tr><td>C = DC 2 Circuit, 4 wire</td><td>E04</td></tr> <tr><td>Q = DC 2 Circuit, 4 wire with 2 power Auxiliary Circuits</td><td>E06</td></tr> <tr><td>R = DC 1 Circuit, 2 Wire</td><td>E02</td></tr> <tr><td>Z = All Black</td><td>E02, E04, E06 & E09</td></tr> </tbody> </table>	Housing Arrangement	Available in Insert Arrangement	0 = Custom Configuration	-	A = AC Single Phase	E04	B = AC 3 Phase, 3 Wire	E04	C = DC 2 Circuit, 4 wire	E04	Q = DC 2 Circuit, 4 wire with 2 power Auxiliary Circuits	E06	R = DC 1 Circuit, 2 Wire	E02	Z = All Black	E02, E04, E06 & E09	<table border="1" style="width: 100%; border-collapse: collapse;"> <thead> <tr> <th style="text-align: left;">Contact Code</th> <th style="text-align: left;">Contact</th> <th style="text-align: left;">Wire Size AWG (mm²)</th> <th style="text-align: left;">Available in Insert Arrangement</th> </tr> </thead> <tbody> <tr><td>00 =</td><td colspan="3">Custom Configuration - Use Next section</td></tr> <tr><td>11 =</td><td>5900</td><td>#6 (13.3)</td><td>E06, E09</td></tr> <tr><td>12 =</td><td>5952</td><td>#8 (8.4)</td><td>E06, E09</td></tr> <tr><td>13 =</td><td>5915</td><td>#10/12 (5.3/3.3)</td><td>E06, E09</td></tr> <tr><td>20 =</td><td>1323G2</td><td>1/0 (53.5)</td><td>E04, E06</td></tr> <tr><td>21 =</td><td>1323G1</td><td>#1 (42.4)</td><td>E04, E06</td></tr> <tr><td>22 =</td><td>1319</td><td>#2 (33.6)</td><td>E04, E06</td></tr> <tr><td>23 =</td><td>1319G4</td><td>#4 (21.2)</td><td>E04, E06</td></tr> <tr><td>24 =</td><td>1319G6</td><td>#6 (13.3)</td><td>E04, E06</td></tr> <tr><td>80 =</td><td>1328G2</td><td>3/0 (85.0)</td><td>E02</td></tr> <tr><td>81 =</td><td>1328G1</td><td>2/0 (67.4)</td><td>E02</td></tr> <tr><td>82 =</td><td>1382</td><td>1/0 (53.5)</td><td>E02</td></tr> <tr><td>83 =</td><td>1347</td><td>#1 (42.4)</td><td>E02</td></tr> <tr><td>84 =</td><td>1383</td><td>#2 (33.6)</td><td>E02</td></tr> <tr><td>85 =</td><td>1384</td><td>#4 (21.2)</td><td>E02</td></tr> <tr><td>86 =</td><td>1348</td><td>#6 (13.3)</td><td>E02</td></tr> </tbody> </table>	Contact Code	Contact	Wire Size AWG (mm²)	Available in Insert Arrangement	00 =	Custom Configuration - Use Next section			11 =	5900	#6 (13.3)	E06, E09	12 =	5952	#8 (8.4)	E06, E09	13 =	5915	#10/12 (5.3/3.3)	E06, E09	20 =	1323G2	1/0 (53.5)	E04, E06	21 =	1323G1	#1 (42.4)	E04, E06	22 =	1319	#2 (33.6)	E04, E06	23 =	1319G4	#4 (21.2)	E04, E06	24 =	1319G6	#6 (13.3)	E04, E06	80 =	1328G2	3/0 (85.0)	E02	81 =	1328G1	2/0 (67.4)	E02	82 =	1382	1/0 (53.5)	E02	83 =	1347	#1 (42.4)	E02	84 =	1383	#2 (33.6)	E02	85 =	1384	#4 (21.2)	E02	86 =	1348	#6 (13.3)	E02	* Custom Configurator
Housing Arrangement	Available in Insert Arrangement																																																																																						
0 = Custom Configuration	-																																																																																						
A = AC Single Phase	E04																																																																																						
B = AC 3 Phase, 3 Wire	E04																																																																																						
C = DC 2 Circuit, 4 wire	E04																																																																																						
Q = DC 2 Circuit, 4 wire with 2 power Auxiliary Circuits	E06																																																																																						
R = DC 1 Circuit, 2 Wire	E02																																																																																						
Z = All Black	E02, E04, E06 & E09																																																																																						
Contact Code	Contact	Wire Size AWG (mm²)	Available in Insert Arrangement																																																																																				
00 =	Custom Configuration - Use Next section																																																																																						
11 =	5900	#6 (13.3)	E06, E09																																																																																				
12 =	5952	#8 (8.4)	E06, E09																																																																																				
13 =	5915	#10/12 (5.3/3.3)	E06, E09																																																																																				
20 =	1323G2	1/0 (53.5)	E04, E06																																																																																				
21 =	1323G1	#1 (42.4)	E04, E06																																																																																				
22 =	1319	#2 (33.6)	E04, E06																																																																																				
23 =	1319G4	#4 (21.2)	E04, E06																																																																																				
24 =	1319G6	#6 (13.3)	E04, E06																																																																																				
80 =	1328G2	3/0 (85.0)	E02																																																																																				
81 =	1328G1	2/0 (67.4)	E02																																																																																				
82 =	1382	1/0 (53.5)	E02																																																																																				
83 =	1347	#1 (42.4)	E02																																																																																				
84 =	1383	#2 (33.6)	E02																																																																																				
85 =	1384	#4 (21.2)	E02																																																																																				
86 =	1348	#6 (13.3)	E02																																																																																				

Part Numbering Notes:

- 1) To order SPEC Pak™ Kits only (no internal Powerpole® housings or contacts), use part numbering on page 4 only. **Plug Kit Example: SK6-142E04.** Powerpole® housings, contacts and wire protection may be ordered separately, see pages 7 thru 10 for information.
- 2) To order customer configured SPEC Pak™ connectors (including internal Powerpole® housings and contacts) use Part Number Plan across the top of pages 4 and 5. **Customer Configured SPEC Pak™ Plug Connector Example: SK6-142E04PS01-A23.**
- 3) To order a custom configuration which is not listed on page 7 thru 10, use APP® custom part number configurator on the APP® website, www.andersonpower.com or contact factory.

* Custom configurations may not be UL Recognized.

Wire Protection - PG Gland

SPECIFICATIONS

Material		Mechanical		Torque Requirements
Shell	Nylon PA 66 (UL94 V-2)*	Operating Temp	-40°C to 105°C (-40°F to 221°F)	Cable Gland Body to Plug Housing
Gasket	EPDM	IP Rating	IP68	- Hand tighten until snug, tighten additional 1/8 - 1/4 turn with wrench
Color	Black	UV Rating	Equivalent to UL746C F1	Sealing Nut to Cable
		Thread Type	PG	- Hand tighten until snug, tighten additional 1/2 - 3/4 turn with wrench

* Contact factory for UL94 V-0 material
 NOTE: Only UL listed cable glands are UL recognized components when used with SPEC Pak™ connector(s).



STRAIGHT PLASTIC SHORT THREAD TYPE - STD PACK 10 / UL LISTED

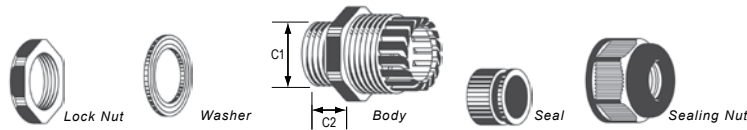

APP® P/N	Wire Protection Designation (4 Characters)	Number Of Holes	Cable Range Wire Outer Dia. mm (in)	Thread O.D. C1 mm (in)	Panel Mounting Hole mm (in)	Thread Length C2 mm (in)	Wrench Size Lock Nut mm	Wrench Size Sealing Nut mm
PL1P42-19X	PS01	1	19.5 - 16.0 (0.77 - 0.63)	54 (2.13)	54 - 54.4 (2.13 - 2.14)	15.5 (0.61)	64	62
PS1P42-32X	PS02	1	32.0 - 26.0 (1.26 - 0.79)	54 (2.13)	54 - 54.4 (2.13 - 2.14)	15.5 (0.61)	64	62

STRAIGHT PLASTIC MULTI-HOLE TYPE - STD PACK 10 / NOT UL LISTED

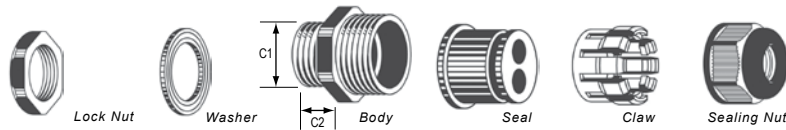

APP® P/N	Wire Protection Designation (4 Characters)	Number Of Holes	Cable Range Wire Outer Dia. mm (in)	Thread O.D. C1 mm (in)	Panel Mounting Hole mm (in)	Thread Length C2 mm (in)	Wrench Size Lock Nut (mm)	Wrench Size Sealing Nut (mm)
PL4P42-10X	PM46	4	10.5 - 8.5 (0.41 - 0.33)	54 (2.13)	54 - 54.4 (2.13 - 2.14)	15.5 (0.61)	64	62
PL6P42-7X	PM66	6	7.0 - 5.0 (0.28 - 0.20)	54 (2.13)	54 - 54.4 (2.13 - 2.14)	15.5 (0.61)	64	62
PL8P42-7X	PM86	8	7.0 - 5.7 (0.28 - 0.22)	54 (2.13)	54 - 54.4 (2.13 - 2.14)	15.5 (0.61)	64	62

NOTE: Custom PG Glands may be available. Contact customer service for more information.

E02 Insert Arrangement

Configured with up to 2 PP180 Contacts (up to 310 amps)
Standard & Custom Configuration Options

HOUSING ARRANGEMENT

0 Custom Configuration *

DC 1 Circuit, 2 Wire

R 1381G1 1381G3

All Black

Z 1381G1 1381G1

NOTE:

(1) For agency approval, contact factory.

* For custom configurations, use APP® custom part number configurator at www.andersonpower.com or contact the factory.

TEMPERATURE CHART

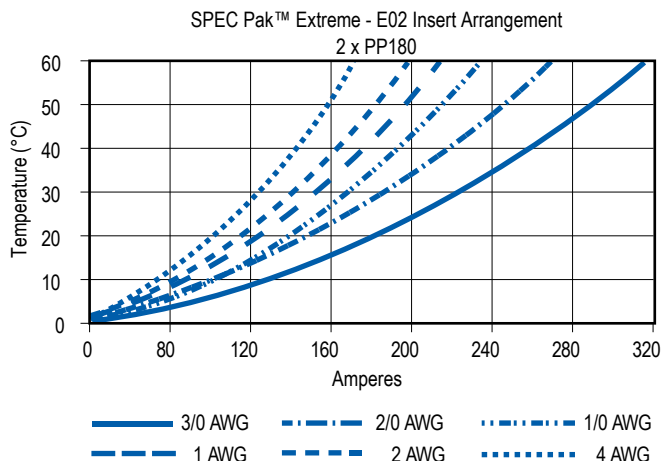

POWERPOLE® CONTACTS & HOUSINGS FOR E02 INSERT ARRANGEMENT

Contacts

Contact Code Designation	Standard Part Number	Standard Package	Bulk Part Number	Bulk Package	Description	Wire Size (AWG)
PP180 Contacts						
80	1328G2	20	1328G2-BK	100	Individual	3/0
81	1328G1	20	1328G1-BK	100	Individual	2/0
82	1382	10	1382-BK	500	Individual	1/0
83	1347	10	1347-BK	500	Individual	#1
84	1383	10	1383-BK	500	Individual	#2
85	1384	10	1384-BK	500	Individual	#4
86	1348	10	1348-BK	500	Individual	#6

Contact Housings

Standard Part Number	Standard Package	Bulk Part Number	Bulk Package	Description
PP180				
1381G1	10	1381G1-BK	250	Black
1381	10	1381-BK	250	Blue
1381G4	10	1381G4-BK	250	Green
1381G3	10	1381G3-BK	250	Red
1381G2	10	1381G2-BK	250	White

NOTE:

(1) See Powerpole® & Multipole Power Connectors Catalog for additional contacts and/or housings options.

(2) Application tooling information is available on page 11.



**E02 Powerpole®
Insert Holder**

E04 Insert Arrangement

Configured with up to 4 PP120 Contacts (up to 200 amps)
Standard & Custom Configuration Options

HOUSING ARRANGEMENT

0 Custom Configuration *

AC Single Phase

A	1321G1	1321G2
	1321G4	E

AC 3 Phase, 3 Wire

B	1321G1	1321G2
	1321G3	1321G4

DC 2 Circuit, 4 Wire

C	1321G1	1321G1
	1321G3	1321G3

All Black

Z	1321G1	1321G1
	1321G1	1321G1

TEMPERATURE CHART

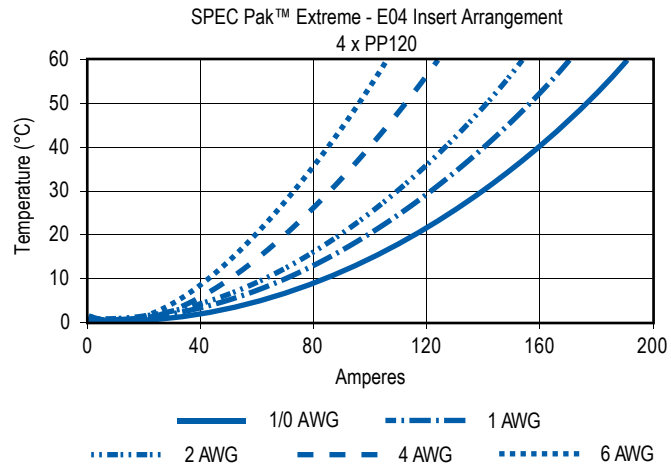

NOTE:

(1) E = Empty

(2) For agency approval, contact factory.

* For custom configurations, use APP® custom part number configurator at www.andersonpower.com or contact the factory.

POWERPOLE® CONTACTS & HOUSINGS FOR E04 & E06 INSERT ARRANGEMENTS

Contacts

Contact Code	Standard Part Number	Standard Package	Bulk Part Number	Bulk Package	Description	Wire Size (AWG)
PP 120 Contacts (for E04 & E06 insert arrangement)						
20	1323G2	20	1323G2-BK	100	Individual	1/0
21	1323G1	20	1323G1-BK	100	Individual	#1
22	1319	20	1319-BK	500	Individual	#2
23	1319G4	20	1319G4-BK	500	Individual	#4
24	1319G6	20	1319G6-BK	500	Individual	#6
PP 75 Contacts (for E06 insert arrangement only)						
11	5900	25	5900-BK	1000	Individual	#6
12	5952	25	5952-BK	1000	Individual	#8
13	5915	100	5915-BK	1000	Individual	#10 to 12

Contact Housings

Standard Part Number	Standard Package	Bulk Part Number	Bulk Package	Description
PP 120 Housings				
1321G1	20	1321G1-BK	500	Black
1321	20	1321-BK	500	Blue
1321G4	20	1321G4-BK	500	Green
1321G3	20	1321G3-BK	500	Red
1321G2	20	1321G2-BK	500	White
PP 75 Housings				
5916G4	25	5916G4-BK	1000	Black
5916	25	5916-BK	1000	Blue
5916G6	25	5916G6-BK	1000	Green
5916G7	25	5916G7-BK	1000	Red
5916G5	25	5916G5-BK	1000	White



**E04 Powerpole®
Insert Holder**



**E06 Powerpole®
Insert Holder**

NOTE:

(1) See Powerpole® & Multipole Power Connectors Catalog for additional contacts and/or housings options.

(2) Application tooling information is available on page 11.

(3) PP15/45 housing adapter (custom configuration) information is available on page 9.

E06 Insert Arrangement

Configured with up to 4 PP120 & 2 PP75 Contacts (up to 200 amps)
Standard & Custom Configuration Options

HOUSING ARRANGEMENT

0 Custom Configuration *

DC 2 Circuit, 4 Wire With 2 Power Auxiliary Circuits

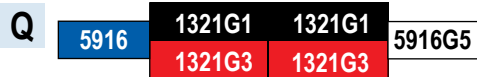

All Black



NOTE:

(1) For agency approval, contact factory.

* For custom configurations, use APP® custom part number configurator at www.andersonpower.com or contact the factory.

TEMPERATURE CHART

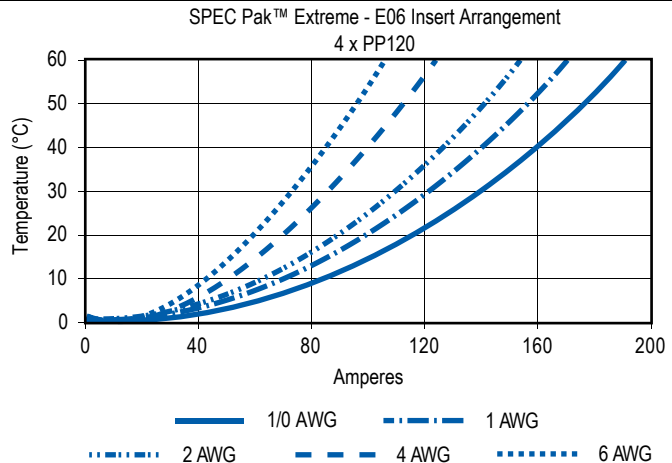

E06 Standard Powerpole® Contacts and Housings Options Are Available On Page 8.

POWERPOLE® CONTACTS & HOUSINGS FOR PP15/45 HOUSING ADAPTER FOR E04 & E06 INSERT ARRANGEMENTS

Contacts

Part Number	Standard Package	Bulk Package	Description	Wire Size AWG
PP 15/45				
200G1L	-	5000	Reeled-LD-Tin Plated	#10 to 20
200G1L-LPBK	100	-	Superflex, Sing. Reel-LD-Tin Plated	#10 to 20
261G2	-	5000	Reeled-HD-Tin Plated	#10 to 20
261G2-LPBK	100	-	Singulated-LD Tin Plate	#10 to 20
1331	100	-	Individual-LD-Silver Plated	#12 to 16
1331-BK	-	1000	Individual-LD-Silver Plated	#12 to 16
261G1	-	5000	Reeled-LD-Tin Plated	#12 to 16
261G1-LBBK	100	-	Singulated-LD Tin Plate	#12 to 16
1332	100	-	Individual-LD-Silver Plated	#16 to 20
1332-BK	-	1000	Individual-LD-Silver Plated	#16 to 20
262G1	-	5000	Reel-LD-Silver Plated	#16 to 20
262G1-LPBK	100	-	Singulated-LD Silver Plate	#16 to 20
PP 15/45 Ground				
1830G1	-	5000	Reel-LD-Tin Plated	#10 to 14
1830G1-LPBK	100	-	Singulated Reel-LD-Tin Plated	#10 to 14
1830G2	-	5000	Reel-LD-Silver Plated	#10 to 14
1830G2-LPBK	1000	-	Singulated Reel-LD-Silver Plated	#10 to 14

Contact Housings

Standard Part Number	Standard Package	Bulk Part Number	Bulk Package	Description
PP 15/45				
1327G6FP	100	1327G6FP-BK	1000	Black
1327G8FP	100	1327G8FP-BK	1000	Blue
1327G5FP	100	1327G5FP-BK	1000	Green
1327FP	100	1327FP-BK	1000	Red
1327G7FP	100	1327G7FP-BK	1000	White
1327G16FP	100	1327G16FP-BK	1000	Yellow
PP 15/45 Ground				
1827G1	100	1827G1-BK	1000	Green

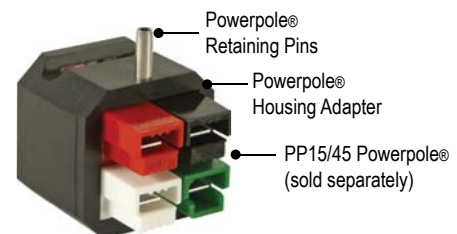

**Housing Adapter
Part Number 2400G1**

NOTE:

(1) See Powerpole® & Multipole Power Connectors

Catalog for additional contacts and/or housings options.

(2) Application tooling information is available on page 11.

(3) Housing adapter (p/n 2400G1) can be used in place of PP120 housing and contact.

E09 Insert Arrangement

Configured with up to 9 PP75 Contacts (up to 75 amps)
Standard & Custom Configuration Options

HOUSING ARRANGEMENT

0 Custom Configuration *

All Black

Z	5916G4	5916G4	5916G4
	5916G4	5916G4	5916G4
	5916G4	5916G4	5916G4

* For custom configurations, use APP® custom part number configurator at www.andersonpower.com or contact the factory.

TEMPERATURE CHART

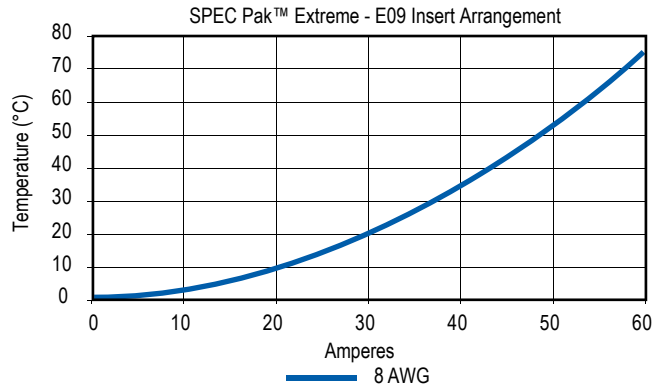

POWERPOLE® CONTACTS & HOUSINGS FOR E09 INSERT ARRANGEMENT

Contacts

Contact Code Designation	Standard Part Number	Standard Package	Bulk Part Number	Bulk Package	Description	Wire Size (AWG)
PP75						
11	5900	25	5900-BK	1000	Individual	#6
12	5952	25	5952-BK	1000	Individual	#8
13	5915	100	5915-BK	1000	Individual	#10 to 12



Contact Housings

Standard Part Number	Standard Package	Bulk Part Number	Bulk Package	Description
PP75				
5916G4	25	5916G4-BK	1000	Black
5916	25	5916-BK	1000	Blue
5916G6	25	5916G6-BK	1000	Green
5916G7	25	5916G7-BK	1000	Red
5916G5	25	5916G5-BK	1000	White



E09 Powerpole®
Insert Holder

NOTE:

- (1) See Powerpole® & Multipole Power Connectors Catalog for additional contacts and/or housings options.
- (2) Application tooling information is available on page 11.
- (3) Shaded box  are  File No. E26226

Tooling Charts

APPLICATION TOOLING

PP15/45 Contact Tools

Contact Loose Piece Part Number	Hand Tool or	Pneumatic Tool	Reeled Part Number	ATS Applicator
1332	1309G2	1367G1	N/A	N/A
1331			N/A	N/A
262G1-LPBK		261G1	1385520	
200G2L-LPBK		200G2L	TBD	
269G2-LPBK	1309G3	N/A	269G2	1385519
261G1-LPBK			261G1	1385520
261G2-LPBK			261G2	1385458
269G1-LPBK			269G1	1385520
269G3-LPBK	269G3		1385458	
200G1L-LPBK	1309G6		200G1L	1385460
201G1H-LPBK			201G1H	1385460
1830G1-LPBK			1830G1	1385460
1830G2-LPBK		1830G2	1385460	

PP75 Contact Tools

Contact Part Number	+ Hand Tool	or	Pneumatic Bench Tool	+ Die	+ Locator
5900	1309G4	or	1387G1	1388G6	1389G6
5952				1388G7	1388G7
5915					

PP120 Contact Tools

Contact Part Number	Dieless Hydraulic Tool	or	Pneumatic Bench Tool	+ Die	+ Locator
1319	1368	or	1387G1	1388G4	1389G4
1319G4					
1319G6					
1323G1				1388G3	1389G3
1323G2					

PP180 Contact Tools

Contact Part Number	Dieless Hydraulic Tool	or	Pneumatic Bench Tool	+ Die	+ Locator		
1382	1368	or	1387G2	1303G4	1304G32		
1383			1387G1	1388G3	1389G3		
1348							
1347							
1384					1388G5	1389G5	
1328G1			1387G2	or	1303G4	1304G32	
1328G2					1303G12		

NOTE: Visit www.andersonpower.com for additional tooling options.



1309



1367G1



1387



1368

Dimensions

PLUG

Top View

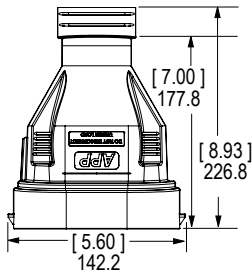

Side View

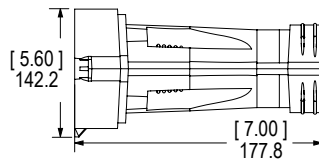

Mated Side View With Receptacle

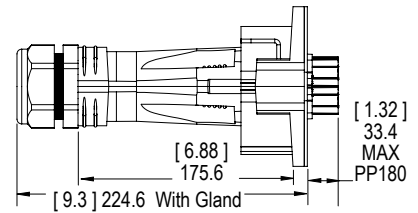

Front View - E02

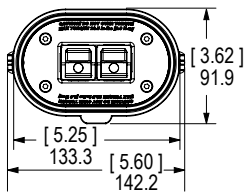

Front View - E04

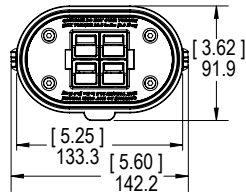

Front View - E06

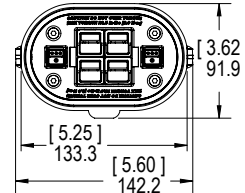

Front View - E09

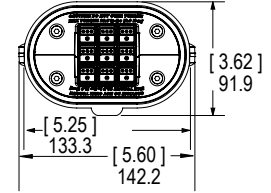

RECEPTACLE

Top View

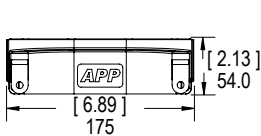

Side View

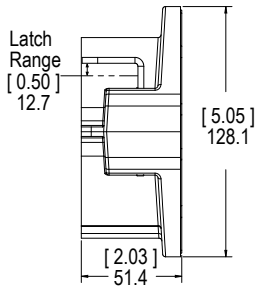

Panel Cut Out

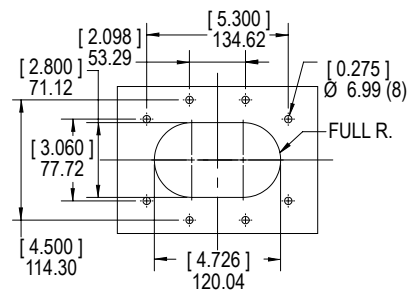

Front View - E02

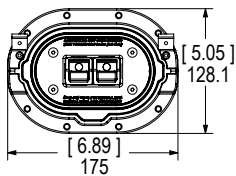

Front View - E04

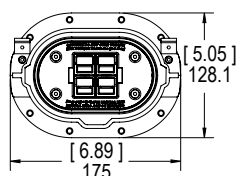

Front View - E06

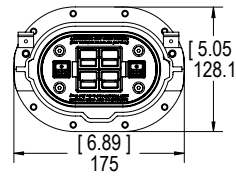

Front View - E09

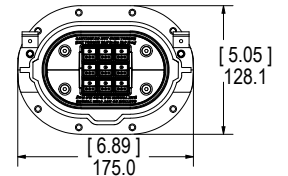

PLUG COVER KIT

Front View

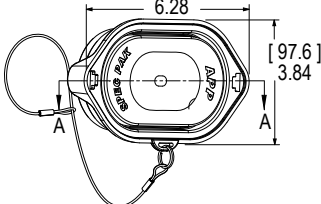

Side View

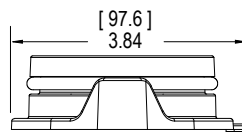

All Data Subject To Change Without Notice Patents with Patents Pending

14838 DS-EXSPAK REV01

HEADQUARTERS: Anderson Power Products®, 13 Pratts Junction Road, Sterling, MA 01564-2305 USA T:978-422-3600 F:978-422-3700

EUROPE: Anderson Power Products® Ltd., Unit 3, Europa Court, Europa Boulevard, Westbrook, Warrington, Cheshire, WA5 7TN United Kingdom T: +44 (0) 1925 428390 F: +44 (0) 1925 520203

ASIA / PACIFIC: IDEAL Anderson Asia Pacific Ltd., Unit 922-928 Topsail Plaza, 11 On Sum Street, Shatin N.T., Hong Kong T: +(852) 2636 0836 F: +(852) 2635 9036

CHINA: IDEAL Anderson Technologies (Shenzhen) Ltd., Block A8 Tantou Western Industrial Park, Songgang Baoan District, Shenzhen, P.R. China 518105 T: +(86) 755 2768 2118 F: +(86) 755 2768 2218

TAIWAN: IDEAL Anderson Asia Pacific Ltd., Taiwan Branch, 4F-2, No.116, Dadun 20th St., Situn District, Taichung City 407, Taiwan (R.O.C.) T: +(886) 4 2310 6451 F: +(886) 4 2310 6460

www.andersonpower.com

Mouser Electronics

Authorized Distributor

Click to View Pricing, Inventory, Delivery & Lifecycle Information:

Anderson Power Products:

[111812P5](#) [124G30](#) [111812P11](#) [111812P12](#) [114896P1](#) [114919G1](#) [2400G1](#) [2-8670P1](#) [2-8671P1](#) [2-8673P1](#) [2-8709P1](#) [3-5955P1](#) [3-5964P1](#) [3-5964P2](#) [3-5972P2](#) [3-5977P1](#) [3-5977P2](#) [3-5981P1](#) [3-5986P2](#) [3-5994P1](#) [4802G3](#) [4803G3](#) [B02082G1](#) [H1120P48](#) [H1120P49](#) [PK2-050B04](#) [PL1P42-19X](#) [SK1-050B04](#) [SK2-050B04](#) [SK2-142E02](#) [SK2-142E04](#) [SK2-142E06](#) [SK2-142E09](#) [SK6-050B04](#) [SK6-142E02](#) [SK6-142E04](#) [SK6-142E06](#) [SK6-142E09](#) [SK9-050](#) [SK9P-142](#) [SK9R-050](#) [2-8693P1](#)