

ORDERING INFORMATION

Tooling

Part Number	Description
1387G3	Hydraulic tool for power contacts
E160-36	Extraction tool

Note: For tooling die information, see tooling chart on website.

DIMENSIONS

Pin Contact

Part AWG	- Wire -		- ØA -		- ØB -		Number mm ²
	mm	in.	mm	in.	mm	in.	
160-1016	16	#6	8.4	0.33	6.0	0.24	
160-1025	25	#4	11.0	0.43	8.0	0.31	
160-1035	35	#2	12.5	0.49	9.0	0.35	
160-1050	50	#1/0	14.5	0.57	11.0	0.43	

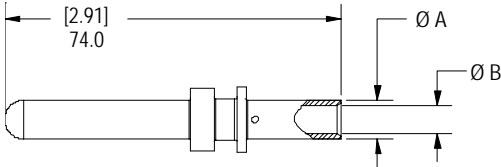

Upper Auxiliary Contact

E160-32 upper auxiliary contact for 4 mm² (#12 AWG)

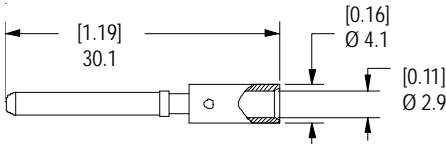

Lower Auxiliary Contact

160-12 lower auxiliary contact for 6 mm² (#10 AWG)

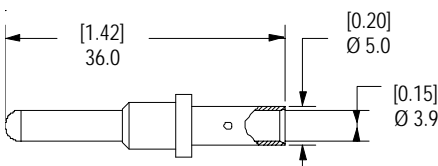

Handle / Lever Assembly / Latch

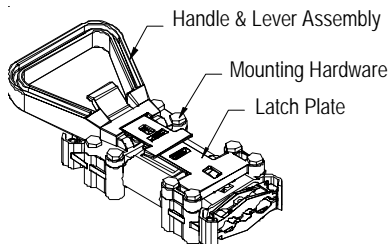

Housing Front View

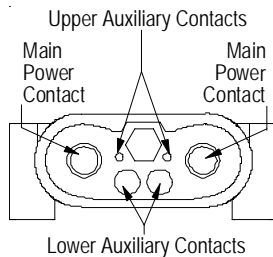

TEMPERATURE CHARTS

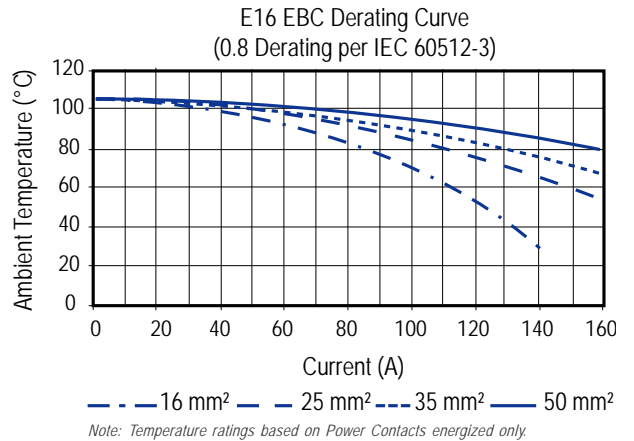
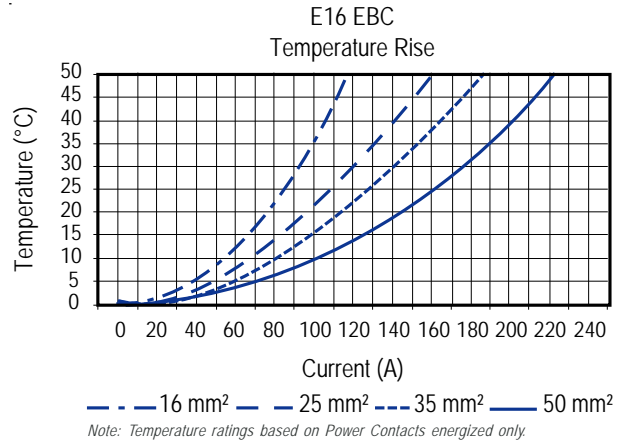

Housing Side View

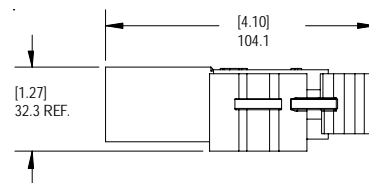

Housing Top View

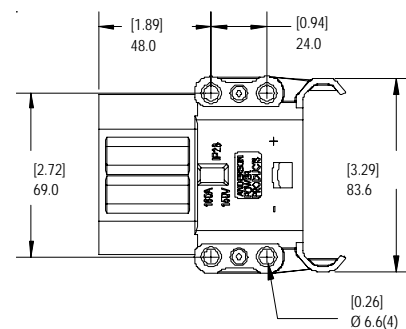

File No. E26226

All Data Subject To Change Without Notice

DS-E16EBCM REV06

HEADQUARTERS: Anderson Power Products®, 13 Pratts Junction Road, Sterling, MA 01564-2305 USA T:978-422-3600 F:978-422-3700

EUROPE: Anderson Power Products® Ltd., Unit 3, Europa Court, Europa Boulevard, Westbrook, Warrington, Cheshire, WA5 7TN United Kingdom T: +44 (0) 1925 428390 F: +44 (0) 1925 428399

ASIA / PACIFIC: IDEAL Anderson Asia Pacific Ltd., Unit 922-928 Topsail Plaza, 11 On Sum Street, Shatin N.T., Hong Kong T: +(852) 2636 0836 F: +(852) 2635 9036

CHINA: IDEAL Anderson Technologies (Shenzhen) Ltd., Block A8 Tantou Western Industrial Park, Songgang Baoan District, Shenzhen, P.R. China 518105 T: +(86) 755 2768 2118 F: +(86) 755 2768 2218

TAIWAN: IDEAL Anderson Asia Pacific Ltd., Taiwan Branch, 4F-2, No.116, Dadun 20th St., Situn District, Taichung City 407, Taiwan (R.O.C.) T: +(886) 4 2310 6451 F: +(886) 4 2310 6460

www.andersonpower.com

Mouser Electronics

Authorized Distributor

Click to View Pricing, Inventory, Delivery & Lifecycle Information:

Anderson Power Products:

[160-1025](#) [E160-20](#) [E16400-0009](#) [E16400-1009](#) [E16416-0009](#) [E16416-1009](#) [E16416-1019](#) [E16416-1029](#) [E16416-1309](#) [E16425-0009](#) [E16425-0049](#) [E16425-1009](#) [E16425-1029](#) [E16435-0008](#) [E16435-0009](#) [E16435-0019](#) [E16435-0049](#) [E16435-1009](#) [E16435-1049](#) [E16435-1059](#) [E16435-1309](#) [E16435-1349](#) [E16450-0009](#) [E16450-0049](#) [E16450-0059](#) [E16450-1009](#) [E16450-1029](#) [E16450-1049](#) [E16416-0208](#) [E16416-0209](#) [E16425-0019](#) [E16435-0059](#) [E16450-0008](#)