Low Noise 150 mA LDO Regulator

No. EA-173-180607

OUTLINE

The RP130x is a voltage regulator IC with high ripple rejection, low dropout voltage, high output voltage accuracy and extremely low supply current. The IC consists of a voltage reference unit, an error amplifier, a resistor-net for voltage setting, a short current limit circuit and a chip enable circuit.

This IC has an excellent low supply current performed by CMOS process, moreover they perform with low dropout voltage due to built-in low on-resistance. A chip enable function prolongs the battery life.

The input transient response, the load transient response and the ripple rejection have been improved in the RP130x compared with the conventional products. Besides achieving low supply current (Typ. 38 μ A).

The range of the operation voltage is capable from 1.7 V to 6.5 V and the range of the output voltage is capable from 1.2 V to 5.3 V for this product, which is wider range as our conventional product R1114x.

The output voltage of this IC is fixed with high accuracy. Since the packages for this IC are DFN(PLP)1010-4, SOT-23-5 and SC-82AB, therefore high density mounting of the IC on board is possible.

FEATURES

- Supply Current Typ. 38 μ A
- Standby Current Typ. 0.1 μ A
- Ripple Rejection Typ. 80 dB (f = 1 kHz)
- Input Voltage Range (Maximum Rating) 1.7 V to 6.5 V (7.0 V)
- Output Voltage Range 1.2 V to 5.3 V (0.1 V step⁽¹⁾)
- Output Voltage Accuracy $\pm 1.0\%$ ($V_{OUT} > 2.0$ V, $T_a = 25^\circ\text{C}$)
- Temperature-Drift Coefficient of Output Voltage Typ. ± 20 ppm/ $^\circ\text{C}$
- Dropout Voltage Typ. 0.32 V ($I_{OUT} = 150$ mA, $V_{OUT} = 2.8$ V)
- Line Regulation Typ. 0.02%/V
- Packages DFN(PLP)1010-4, SC-82AB, SOT-23-5
- Built-in Fold Back Protection Circuit Typ. 40 mA
- Ceramic capacitors are recommended to be used with this IC 0.47 μ F or more

APPLICATIONS

- Power source for battery-powered equipment.
- Power source for portable communication equipment.
- Power source for electrical appliances such as cameras, VCRs and camcorders.
- Power source for high stable reference voltage.

⁽¹⁾ For other voltages, please refer to *SELECTION GUIDE*.

RP130x

No. EA-173-180607

SELECTION GUIDE

The set output voltage, chip enable polarity, auto-discharge function⁽¹⁾, and packages for the IC can be selected at the user's request.

Selection Guide

Product Name	Package	Quantity per Reel	Pb Free	Halogen Free
RP130Kxx1*-TR	DFN(PLP)1010-4	10,000 pcs	Yes	Yes
RP130Qxx1*-TR-FE	SC-82AB	3,000 pcs	Yes	Yes
RP130Nxx1*-TR-FE	SOT-23-5	3,000 pcs	Yes	Yes

xx : Set Output Voltage (V_{SET})

Fixed Type: 12 to 53 Stepwise setting with 0.1 V increment in the range from 1.2 V to 5.3 V

Exception: 1.25 V = RP130x121*5

1.85 V = RP130x181*5

2.85 V = RP130x281*5

3.45 V = RP130x341*5

4.25 V = RP130x421*5

* : CE pin polarity and auto-discharge function at off state are options as follows.

A: active low, without auto-discharge function at off state.

B: active high, without auto-discharge function at off state.

D: active high, with auto-discharge function at off state.

⁽¹⁾ Auto-discharge function quickly lowers the output voltage to 0 V by releasing the electrical charge in the external capacitor when the chip enable signal is switched from the active mode to the standby mode.

BLOCK DIAGRAMS

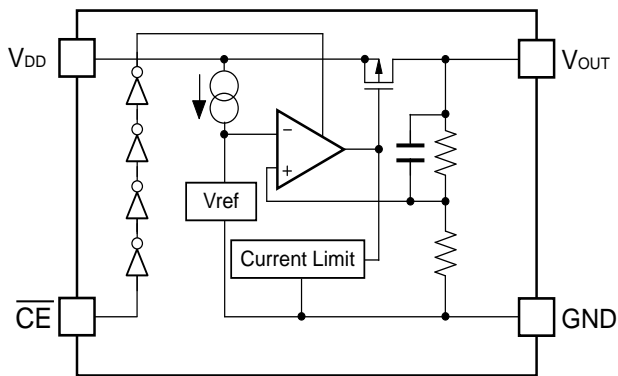

RP130xxx1A Block Diagram

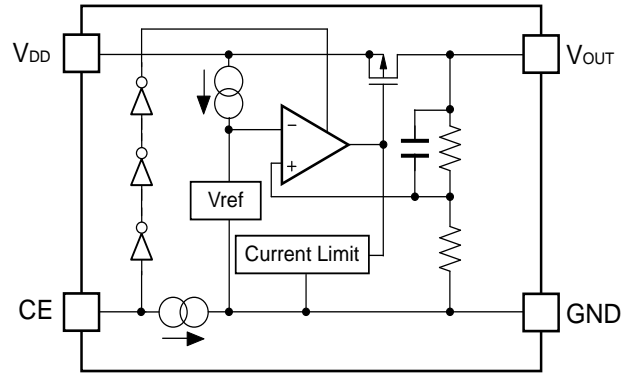

RP130xxx1B Block Diagram

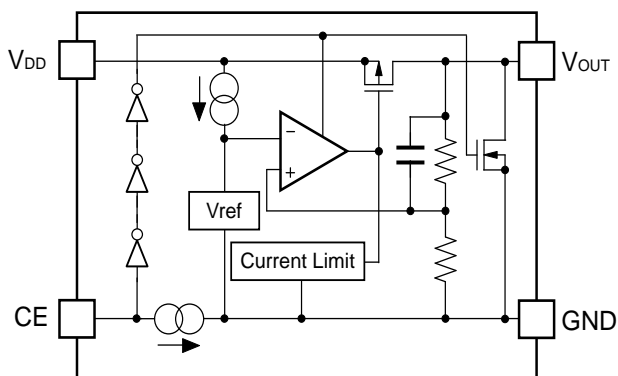

RP130xxx1D Block Diagram

RP130x

No. EA-173-180607

PIN DESCRIPTIONS

Top View

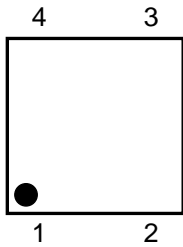

Bottom View

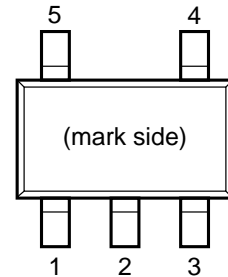
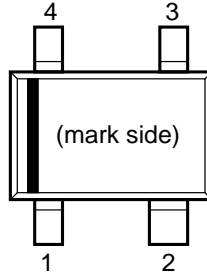
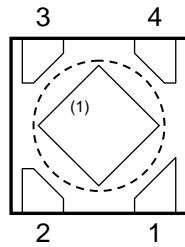

DFN(PLP)1010-4 Pin Configuration

SC-82AB Pin Configuration

SOT-23-5 Pin Configuration

DFN(PLP)1010-4 Pin Description

Pin No	Symbol	Pin Description
1	VOUT	Output Pin
2	GND	Ground Pin
3	$\overline{\text{CE}} / \text{CE}$	Chip Enable Pin ("L" Active / "H" Active)
4	VDD	Input Pin

SC-82AB Pin Description

Pin No	Symbol	Pin Description
1	$\overline{\text{CE}} / \text{CE}$	Chip Enable Pin ("L" Active / "H" Active)
2	GND	Ground Pin
3	VOUT	Output Pin
4	VDD	Input Pin

SOT-23-5 Pin Description

Pin No	Symbol	Pin Description
1	VDD	Input Pin
2	GND	Ground Pin
3	$\overline{\text{CE}} / \text{CE}$	Chip Enable Pin ("L" Active / "H" Active)
4	NC	No Connection
5	VOUT	Output Pin

⁽¹⁾ Tab is GND level (they are connected to the reverse side of this IC). The tab is better to be connected to the GND, but leaving it open is also acceptable.

ABSOLUTE MAXIMUM RATINGS

Absolute Maximum Ratings

Symbol	Item		Rating	Unit	
V _{IN}	Input Voltage		7.0	V	
V _{CE}	Input Voltage (CE Pin)		-0.3 to 7.0	V	
V _{OUT}	Output Voltage		-0.3 to V _{IN} + 0.3	V	
I _{OUT}	Output Current		200	mA	
P _D	Power Dissipation ⁽¹⁾	DFN(PLP)1010-4	JEDEC STD. 51-7 Test Land Pattern	800	mW
		SC-82AB	Standard Test Land Pattern	380	
		SOT-23-5	JEDEC STD. 51-7 Test Land Pattern	660	
T _j	Junction Temperature Range		-40 to 125	°C	
T _{stg}	Storage Temperature Range		-55 to 125	°C	

ABSOLUTE MAXIMUM RATINGS

Electronic and mechanical stress momentarily exceeded absolute maximum ratings may cause the permanent damages and may degrade the lifetime and safety for both device and system using the device in the field. The functional operation at or over these absolute maximum ratings are not assured.

RECOMMENDED OPERATING CONDITIONS

Recommended Operating Conditions

Symbol	Item	Rating	Unit
V _{IN}	Input Voltage	1.7 to 6.5	V
T _a	Operating Temperature Range	-40 to 85	°C

RECOMMENDED OPERATING CONDITIONS

All of electronic equipment should be designed that the mounted semiconductor devices operate within the recommended operating conditions. The semiconductor devices cannot operate normally over the recommended operating conditions, even if when they are used over such conditions by momentary electronic noise or surge. And the semiconductor devices may receive serious damage when they continue to operate over the recommended operating conditions.

⁽¹⁾ Refer to *POWER DISSIPATION* for detailed information.

RP130x

No. EA-173-180607

ELECTRICAL CHARACTERISTICS

$V_{IN} = V_{SET} + 1\text{ V}$ ($V_{OUT} > 1.5\text{ V}$), $V_{IN} = 2.5\text{ V}$ ($V_{OUT} \leq 1.5\text{ V}$), $I_{OUT} = 1\text{ mA}$, $C_{IN} = C_{OUT} = 0.47\text{ }\mu\text{F}$, unless otherwise noted.

The specifications surrounded by are guaranteed by design engineering at $-40^{\circ}\text{C} \leq T_a \leq 85^{\circ}\text{C}$.

RP130xxx1A Electrical Characteristics

($T_a = 25^{\circ}\text{C}$)

Symbol	Item	Conditions	Min.	Typ.	Max.	Unit	
V_{OUT}	Output Voltage	$T_a = 25^{\circ}\text{C}$	$V_{SET} > 2.0\text{ V}$	x 0.99	x 1.01	V	
			$V_{SET} \leq 2.0\text{ V}$	-20	20	mV	
		$-40^{\circ}\text{C} \leq T_a \leq 85^{\circ}\text{C}$	$V_{SET} > 2.0\text{ V}$	x0.985		x1.015	V
			$V_{SET} \leq 2.0\text{ V}$	-30		30	mV
I_{LIM}	Output Current Limit		150		mA		
$\frac{\Delta V_{OUT}}{\Delta I_{OUT}}$	Load Regulation	$1\text{ mA} \leq I_{OUT} \leq 150\text{ mA}$		10	30	mV	
V_{DIF}	Dropout Voltage	$I_{OUT} = 150\text{ mA}$	$1.2\text{ V} \leq V_{SET} < 1.5\text{ V}$		0.67	1.00	V
			$1.5\text{ V} \leq V_{SET} < 1.7\text{ V}$		0.54	0.81	
			$1.7\text{ V} \leq V_{SET} < 2.0\text{ V}$		0.46	0.68	
			$2.0\text{ V} \leq V_{SET} < 2.5\text{ V}$		0.41	0.60	
			$2.5\text{ V} \leq V_{SET} < 4.0\text{ V}$		0.32	0.51	
			$4.0\text{ V} \leq V_{SET}$		0.24	0.37	
I_{SS}	Supply Current	$I_{OUT} = 0\text{ mA}$		38	58	μA	
$I_{standby}$	Supply Current (Standby)	$V_{CE} = V_{IN}$		0.1	1.0	μA	
$\frac{\Delta V_{OUT}}{\Delta V_{IN}}$	Line Regulation	$V_{SET} + 0.5\text{ V} \leq V_{IN} \leq 6.5\text{ V}$		0.02	0.10	%/V	
RR	Ripple Rejection	$f = 1\text{ kHz}$, Ripple 0.2 Vp-p $V_{IN} = V_{SET} + 1\text{ V}$ $I_{OUT} = 30\text{ mA}$ (In case that $V_{OUT} \leq 2.0\text{ V}$, $V_{IN} = 3.0\text{ V}$)		80		dB	
V_{IN}	Input Voltage		1.7		6.5	V	
$\frac{\Delta V_{OUT}}{\Delta T_a}$	Output Voltage Temperature Coefficient	$-40^{\circ}\text{C} \leq T_a \leq 85^{\circ}\text{C}$		± 20		ppm/ $^{\circ}\text{C}$	
I_{SC}	Short Current Limit	$V_{OUT} = 0\text{ V}$		40		mA	
V_{CEH}	\overline{CE} Input Voltage "H"		1.0			μA	
V_{CEL}	\overline{CE} Input Voltage "L"				0.4		
en	Output Noise	BW = 10 Hz to 100 kHz $I_{OUT} = 30\text{ mA}$		20 x V_{SET}		μVrms	

All test items listed under *Electrical Characteristics* are done under the pulse load condition ($T_j \approx T_a = 25^{\circ}\text{C}$) except for Output Noise, Ripple Rejection, and Output Voltage Temperature Coefficient.

ELECTRICAL CHARACTERISTICS (continued)

$V_{IN} = V_{SET} + 1\text{ V}$ ($V_{OUT} > 1.5\text{ V}$), $V_{IN} = 2.5\text{ V}$ ($V_{OUT} \leq 1.5\text{ V}$), $I_{OUT} = 1\text{ mA}$, $C_{IN} = C_{OUT} = 0.47\text{ }\mu\text{F}$, unless otherwise noted.

The specifications surrounded by are guaranteed by design engineering at $-40^{\circ}\text{C} \leq T_a \leq 85^{\circ}\text{C}$.

RP130xxx1B/D Electrical Characteristics

($T_a = 25^{\circ}\text{C}$)

Symbol	Item	Conditions	Min.	Typ.	Max.	Unit	
V_{OUT}	Output Voltage	$T_a = 25^{\circ}\text{C}$	$V_{SET} > 2.0\text{ V}$	x 0.99		x 1.01	V
			$V_{SET} \leq 2.0\text{ V}$	-20		20	mV
		$-40^{\circ}\text{C} \leq T_a \leq 85^{\circ}\text{C}$	$V_{SET} > 2.0\text{ V}$	x 0.985		x 1.015	V
			$V_{SET} \leq 2.0\text{ V}$	-30		30	mV
I_{LIM}	Output Current Limit		150			mA	
$\frac{\Delta V_{OUT}}{\Delta I_{OUT}}$	Load Regulation	$1\text{ mA} \leq I_{OUT} \leq 150\text{ mA}$		10	30	mV	
V_{DIF}	Dropout Voltage	$I_{OUT} = 150\text{ mA}$	$1.2\text{ V} \leq V_{SET} < 1.5\text{ V}$		0.67	1.00	
			$1.5\text{ V} \leq V_{SET} < 1.7\text{ V}$		0.54	0.81	
			$1.7\text{ V} \leq V_{SET} < 2.0\text{ V}$		0.46	0.68	
			$2.0\text{ V} \leq V_{SET} < 2.5\text{ V}$		0.41	0.60	
			$2.5\text{ V} \leq V_{SET} < 4.0\text{ V}$		0.32	0.51	
			$4.0\text{ V} \leq V_{SET}$		0.24	0.37	
I_{SS}	Supply Current	$I_{OUT} = 0\text{ mA}$		38	58	μA	
$I_{standby}$	Standby Current	$V_{CE} = V_{IN}$		0.1	1.0	μA	
$\frac{\Delta V_{OUT}}{\Delta V_{IN}}$	Line Regulation	$V_{SET} + 0.5\text{ V} \leq V_{IN} \leq 6.5\text{ V}$		0.02	0.10	%/V	
RR	Ripple Rejection	$f = 1\text{ kHz}$, Ripple 0.2 Vp-p $V_{IN} = V_{SET} + 1\text{ V}$, $I_{OUT} = 30\text{ mA}$ (In case that $V_{OUT} \leq 2.0\text{ V}$, $V_{IN} = 3.0\text{ V}$)		80		dB	
V_{IN}	Input Voltage		1.7		6.5	V	
$\frac{\Delta V_{OUT}}{\Delta T_a}$	Output Voltage Temperature Coefficient	$-40^{\circ}\text{C} \leq T_a \leq 85^{\circ}\text{C}$		± 20		ppm/ $^{\circ}\text{C}$	
I_{SC}	Short Current Limit	$V_{OUT} = 0\text{ V}$		40		mA	
I_{PD}	CE Pull-down Current			0.4		μA	
V_{CEH}	$\overline{\text{CE}}$ Input Voltage "H"		1.0			μA	
V_{CEL}	$\overline{\text{CE}}$ Input Voltage "L"				0.4		
en	Output Noise	BW = 10 Hz to 100 kHz $I_{OUT} = 30\text{ mA}$		20 x V_{SET}		μVrms	
R_{LOW}	Nch ON Resistance for Auto Discharge (RP130xxx1D)	$V_{IN} = 4.0\text{ V}$ $V_{CE} = 0\text{ V}$		30		Ω	

All test items listed under *Electrical Characteristics* are done under the pulse load condition ($T_j \approx T_a = 25^{\circ}\text{C}$) except for Output Noise, Ripple Rejection, and Output Voltage Temperature Coefficient.

RP130x

No. EA-173-180607

The specifications surrounded by are guaranteed by design engineering at $-40^{\circ}\text{C} \leq T_a \leq 85^{\circ}\text{C}$.

Product-specific Electrical Characteristics

($T_a = 25^{\circ}\text{C}$)

Product Name	$V_{\text{OUT}} [\text{V}]$ ($T_a = 25^{\circ}\text{C}$)			$V_{\text{OUT}} [\text{V}]$ ($T_a = -40^{\circ}\text{C}$ to 85°C)			$V_{\text{DIF}} [\text{V}]$	
	Min.	Typ.	Max.	Min.	Typ.	Max.	Typ.	Max.
RP130x121x	1.180	1.2	1.220	1.170	1.2	1.230	0.67	1.00
RP130x121x5	1.230	1.25	1.270	1.220	1.25	1.280		
RP130x131x	1.280	1.3	1.320	1.270	1.3	1.330		
RP130x141x	1.380	1.4	1.420	1.370	1.4	1.430	0.54	0.81
RP130x151x	1.480	1.5	1.520	1.470	1.5	1.530		
RP130x161x	1.580	1.6	1.620	1.570	1.6	1.630		
RP130x171x	1.680	1.7	1.720	1.670	1.7	1.730	0.46	0.68
RP130x181x	1.780	1.8	1.820	1.770	1.8	1.830		
RP130x181x5	1.830	1.85	1.870	1.820	1.85	1.880		
RP130x191x	1.880	1.9	1.920	1.870	1.9	1.930	0.41	0.60
RP130x201x	1.980	2.0	2.020	1.970	2.0	2.030		
RP130x211x	2.079	2.1	2.121	2.069	2.1	2.132		
RP130x221x	2.178	2.2	2.222	2.167	2.2	2.233	0.32	0.51
RP130x231x	2.277	2.3	2.323	2.266	2.3	2.335		
RP130x241x	2.376	2.4	2.424	2.364	2.4	2.436		
RP130x251x	2.475	2.5	2.525	2.463	2.5	2.538	0.24	0.37
RP130x261x	2.574	2.6	2.626	2.561	2.6	2.639		
RP130x271x	2.673	2.7	2.727	2.660	2.7	2.741		
RP130x281x	2.772	2.8	2.828	2.758	2.8	2.842	0.24	0.37
RP130x281x5	2.822	2.85	2.879	2.807	2.85	2.893		
RP130x291x	2.871	2.9	2.929	2.857	2.9	2.944		
RP130x301x	2.970	3.0	3.030	2.955	3.0	3.045	0.24	0.37
RP130x311x	3.069	3.1	3.131	3.054	3.1	3.147		
RP130x321x	3.168	3.2	3.232	3.152	3.2	3.248		
RP130x331x	3.267	3.3	3.333	3.251	3.3	3.350	0.24	0.37
RP130x341x	3.366	3.4	3.434	3.349	3.4	3.451		
RP130x341x5	3.416	3.45	3.485	3.398	3.45	3.502		
RP130x351x	3.465	3.5	3.535	3.448	3.5	3.553	0.24	0.37
RP130x361x	3.564	3.6	3.636	3.546	3.6	3.654		
RP130x371x	3.663	3.7	3.737	3.645	3.7	3.756		
RP130x381x	3.762	3.8	3.838	3.743	3.8	3.857	0.24	0.37
RP130x391x	3.861	3.9	3.939	3.842	3.9	3.959		
RP130x401x	3.960	4.0	4.040	3.940	4.0	4.060		
RP130x411x	4.059	4.1	4.141	4.039	4.1	4.162	0.24	0.37
RP130x421x	4.158	4.2	4.242	4.137	4.2	4.263		
RP130x421x5	4.208	4.25	4.293	4.186	4.25	4.314		
RP130x431x	4.257	4.3	4.343	4.236	4.3	4.365	0.24	0.37
RP130x441x	4.356	4.4	4.444	4.334	4.4	4.466		
RP130x451x	4.455	4.5	4.545	4.433	4.5	4.568		
RP130x461x	4.554	4.6	4.646	4.531	4.6	4.669	0.24	0.37
RP130x471x	4.653	4.7	4.747	4.630	4.7	4.771		
RP130x481x	4.752	4.8	4.848	4.728	4.8	4.872		
RP130x491x	4.851	4.9	4.949	4.827	4.9	4.974	0.24	0.37
RP130x501x	4.950	5.0	5.050	4.925	5.0	5.075		
RP130x511x	5.049	5.1	5.151	5.024	5.1	5.177		
RP130x521x	5.148	5.2	5.252	5.122	5.2	5.278	0.24	0.37
RP130x531x	5.247	5.3	5.353	5.221	5.3	5.380		

APPLICATION INFORMATION

TYPICAL APPLICATION

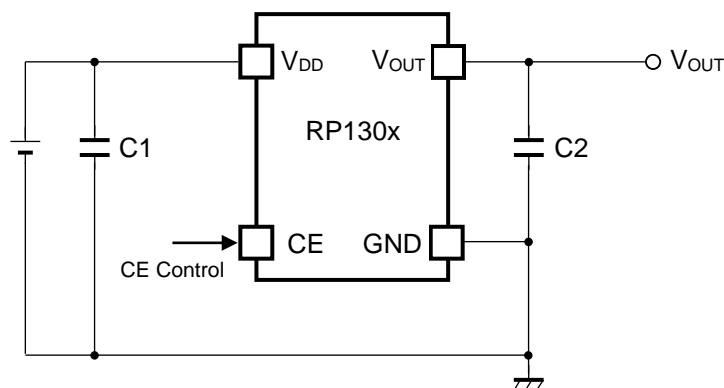

RP130x Typical Application

External Components

Symbol	Descriptions
C1, C2	0.47 μ F, Ceramic Capacitor, Murata, GRM155B30J474KE18B

TECHNICAL NOTES

Phase Compensation

In these ICs, phase compensation is made for securing stable operation even if the load current is varied. For this purpose, use a capacitor C2 with 0.47 μ F or more. If a tantalum capacitor is used, and its ESR (Equivalent Series Resistance) of C2 is large, the loop oscillation may result. Because of this, select C2 carefully considering its frequency characteristics.

PCB Layout

Make VDD and GND lines sufficient. If their impedance is high, noise pickup or unstable operation may result. Connect a capacitor C1 with a capacitance value as much as 0.47 μ F or more between VDD and GND pin, and as close as possible to the pins. Set external components, especially the output capacitor C2, as close as possible to the ICs, and make wiring as short as possible.

RP130x

No. EA-173-180607

TYPICAL CHARACTERISTICS

Typical characteristics are intended to be used as reference data, they are not guaranteed.

1) Output Voltage vs. Output Current ($C_1 = 0.47 \mu\text{F}$, $C_2 = 0.47 \mu\text{F}$, $T_a = 25^\circ\text{C}$)

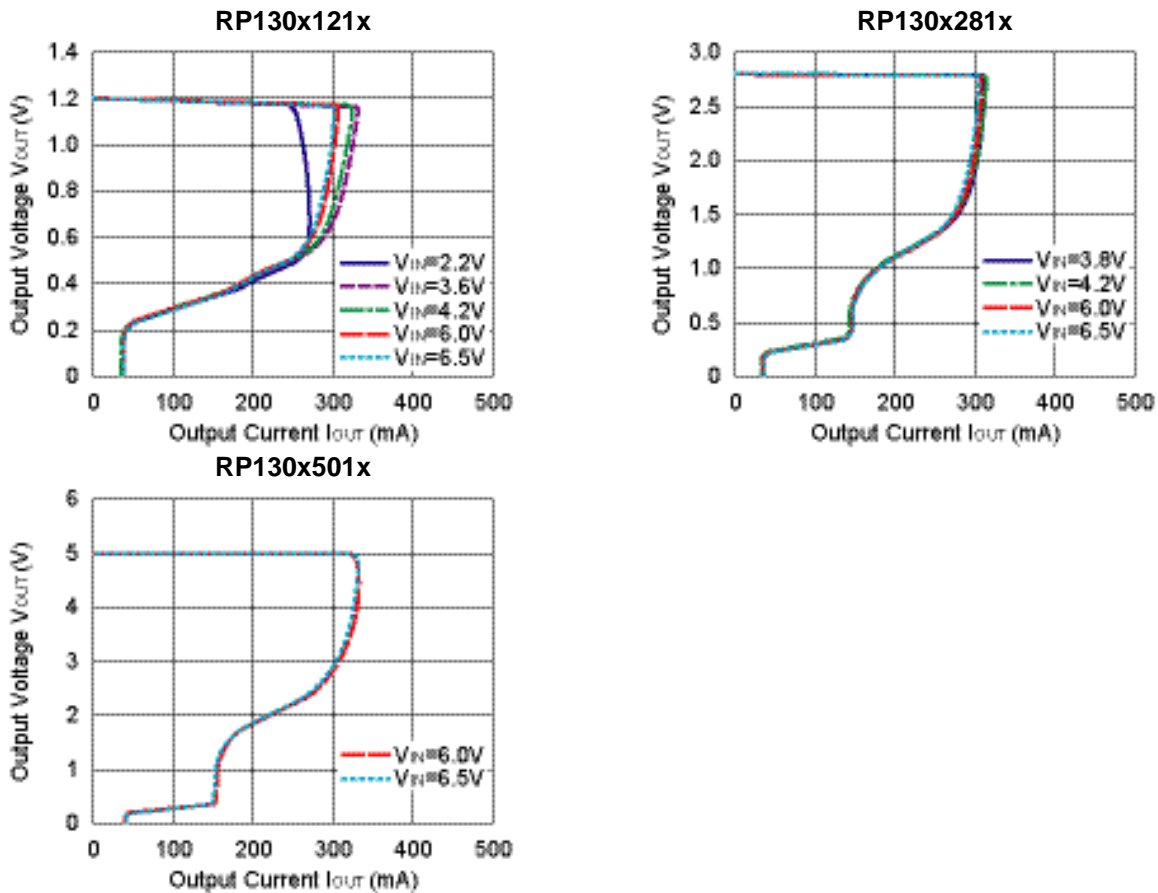

2) Output Voltage vs. Input Voltage ($C_1 = 0.47 \mu\text{F}$, $C_2 = 0.47 \mu\text{F}$, $T_a = 25^\circ\text{C}$)

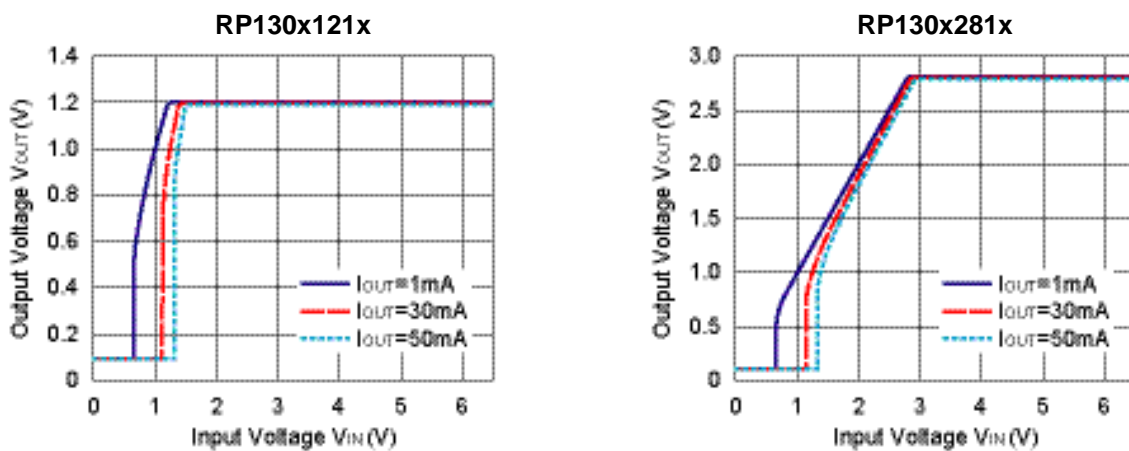

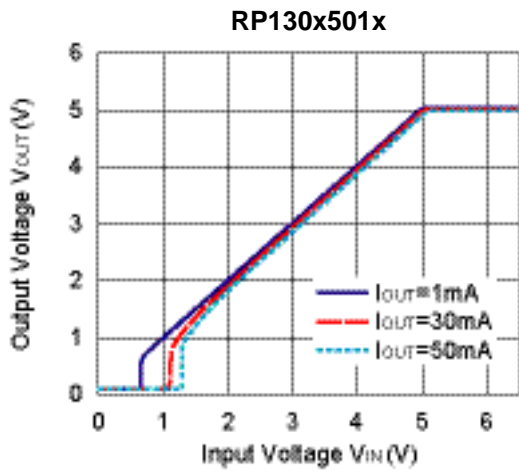

3) Supply Current vs. Input Voltage ($C1 = 0.47 \mu F$, $C2 = 0.47 \mu F$, $T_a = 25^\circ C$)

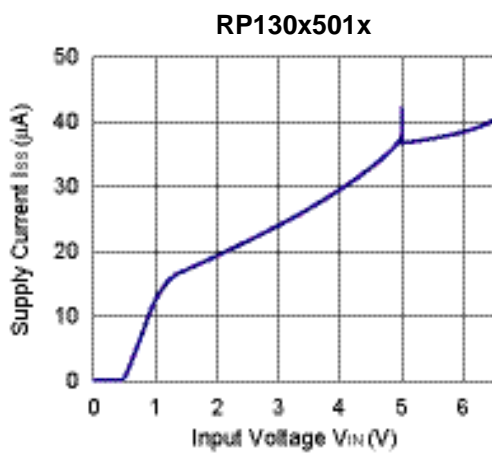
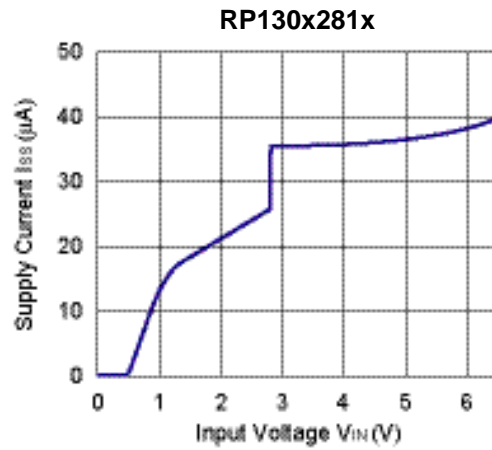
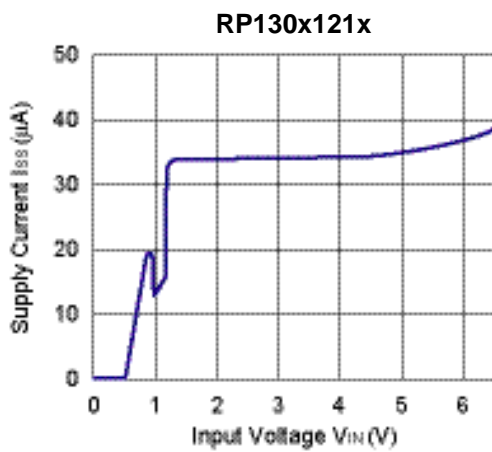

RP130x

No. EA-173-180607

4) Output Voltage vs. Temperature ($I_{OUT} = 1 \text{ mA}$, $C1 = 0.47 \mu\text{F}$, $C2 = 0.47 \mu\text{F}$)

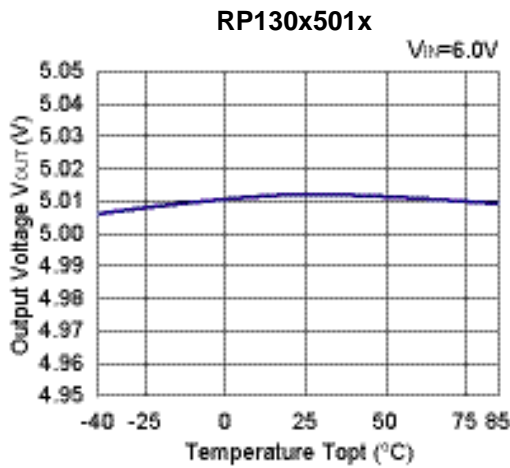
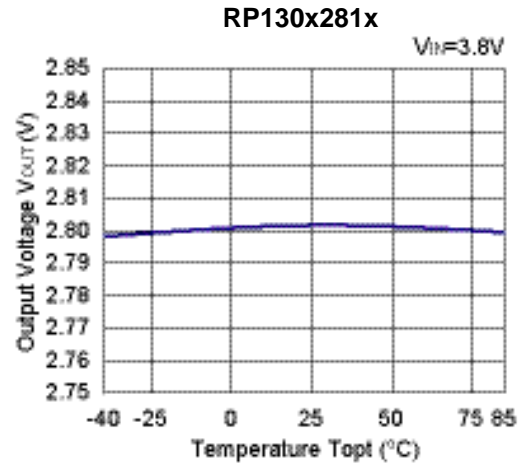
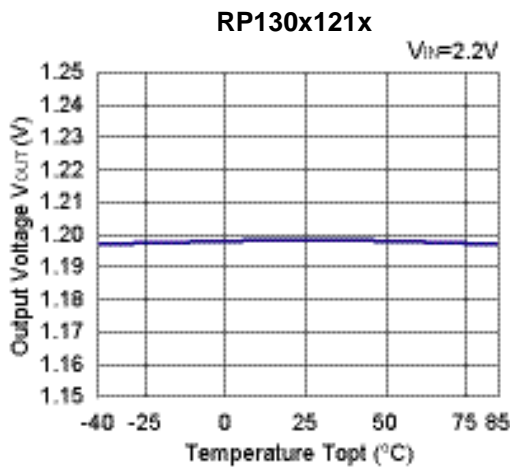

5) Supply Current vs. Temperature ($I_{OUT} = 0 \text{ mA}$, $C1 = 0.47 \mu\text{F}$, $C2 = 0.47 \mu\text{F}$)

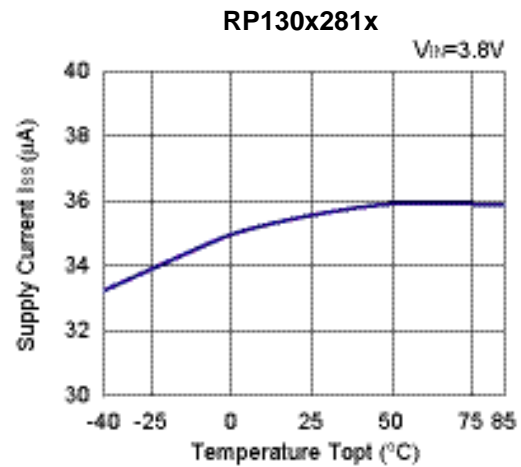
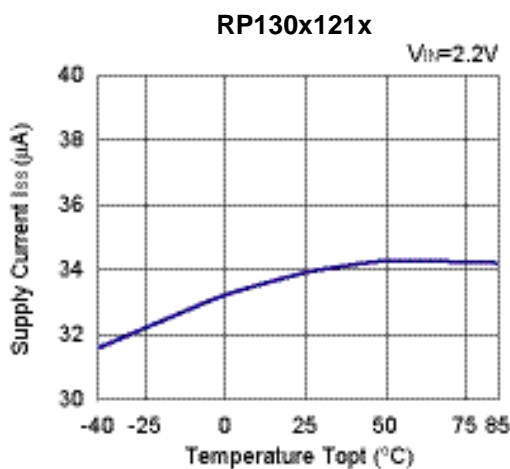

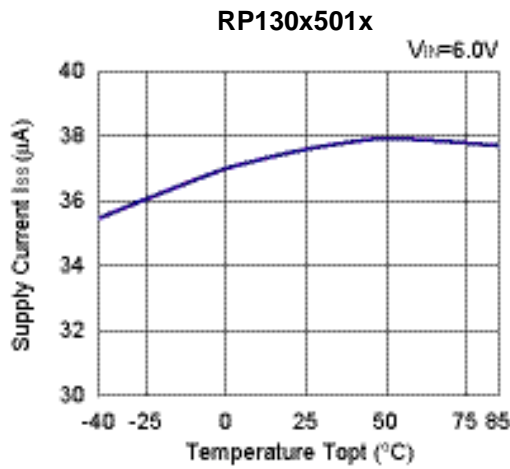

6) Dropout Voltage vs. Output Current ($C1 = 0.47 \mu F$, $C2 = 0.47 \mu F$)

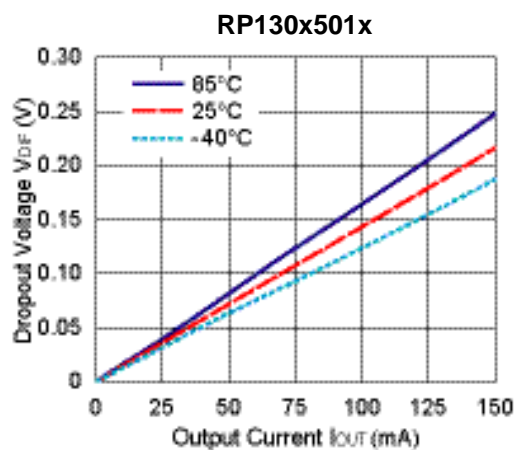
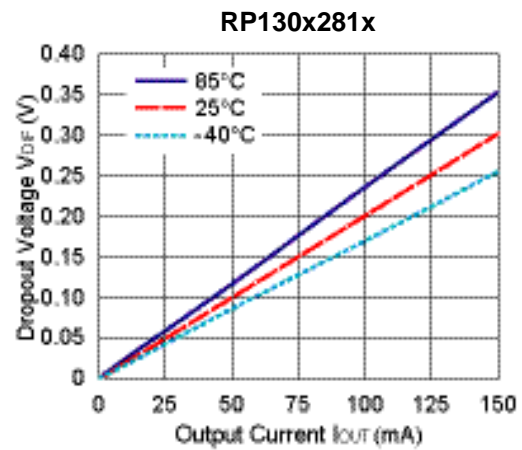
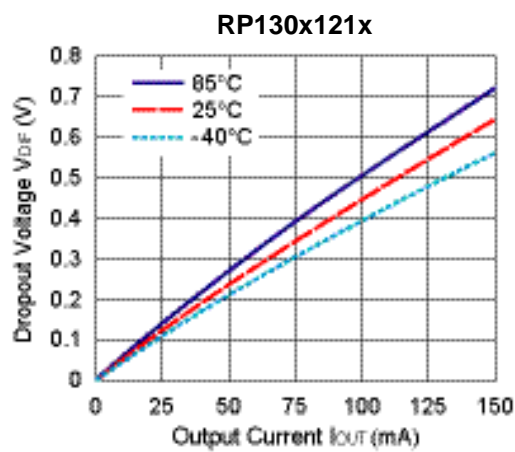

RP130x

No. EA-173-180607

7) Dropout Voltage vs. Set Output Voltage (C1 = 0.47 μ F, C2 = 0.47 μ F)

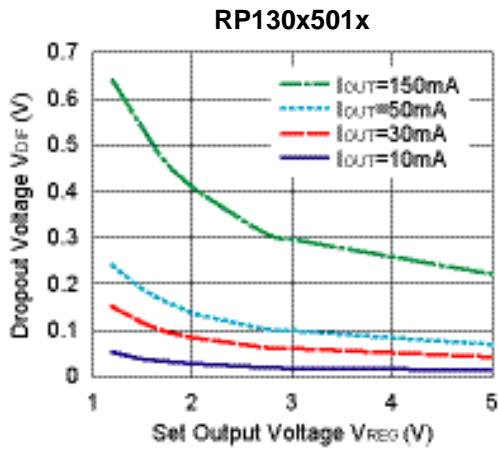

8) Ripple Rejection vs. Input Bias Voltage (C1 = none, C2 = 0.47 μ F, Ripple = 0.2 Vp-p, $T_a = 25^\circ C$)

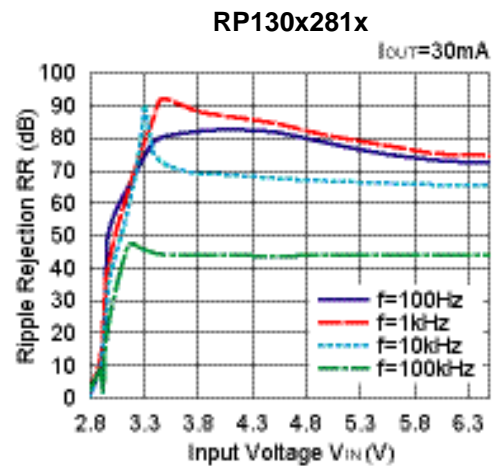
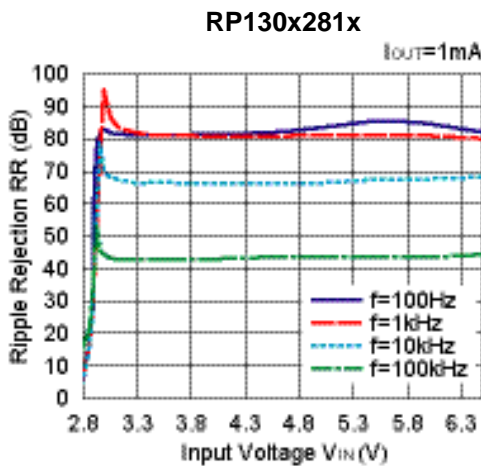

9) Ripple Rejection vs. Frequency (C1 = none, C2 = 0.47 μ F, Ripple = 0.2 Vp-p, $T_a = 25^\circ C$)

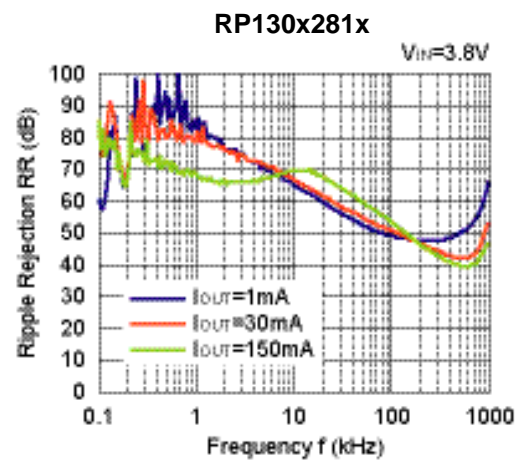
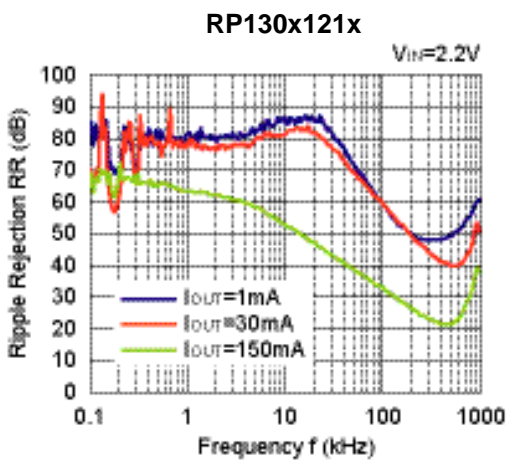

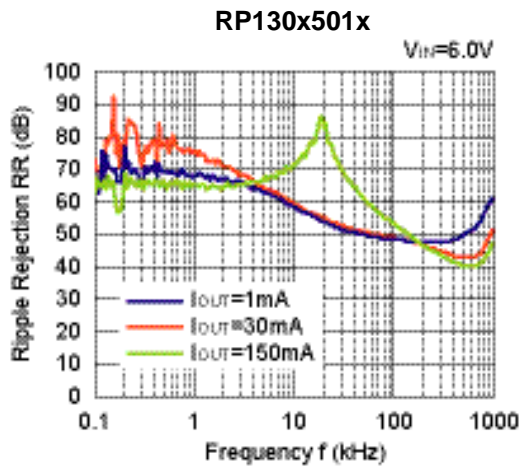

10) Input Transient Response ($I_{OUT} = 30\text{ mA}$, $t_r = t_f = 5\ \mu\text{s}$, $C_1 = \text{none}$, $C_2 = 0.47\ \mu\text{F}$, $T_a = 25^\circ\text{C}$)

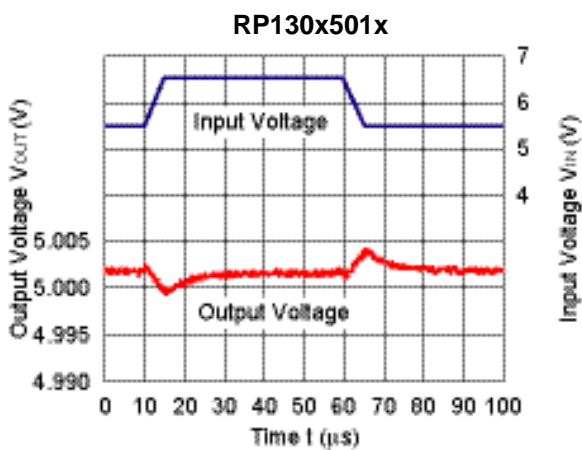
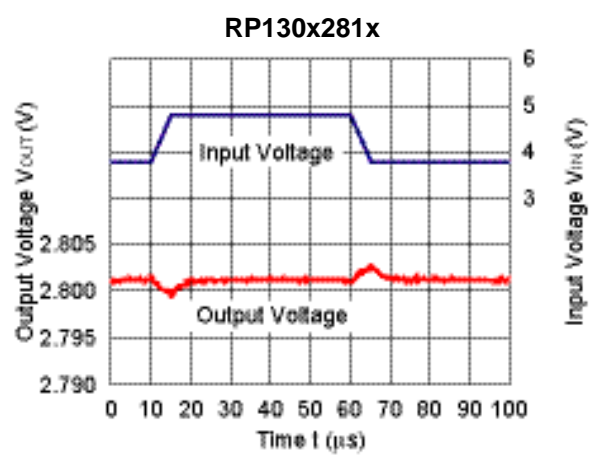
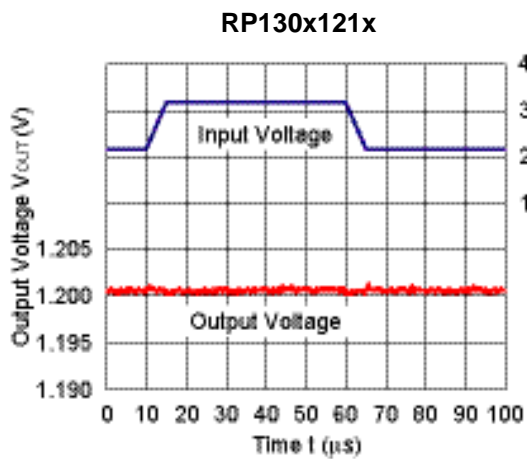

RP130x

No. EA-173-180607

11) Load Transient Response

($t_r = t_f = 0.5 \mu\text{s}$, $C_1 = 0.47 \mu\text{F}$, $C_2 = 0.47 \mu\text{F}$, $I_{\text{OUT}} = 50\text{mA} \leftrightarrow 100 \text{mA}$, $T_a = 25^\circ\text{C}$)

RP130x121x

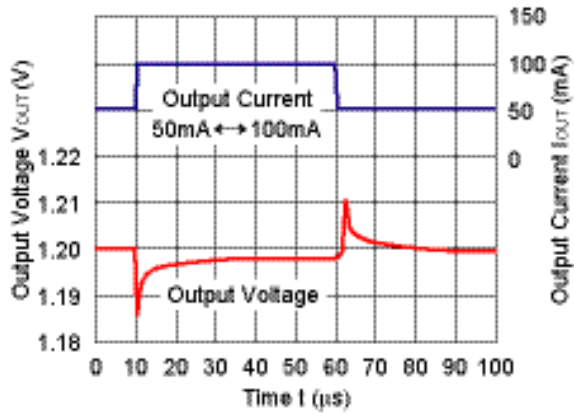

RP130x281x

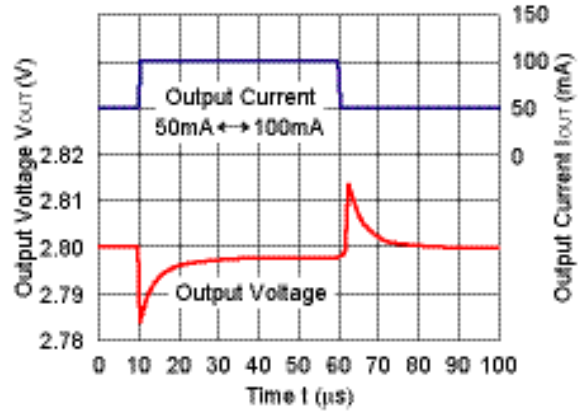

RP130x501x

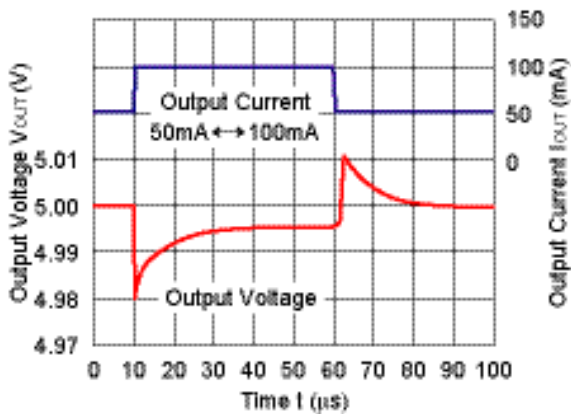

12) Load Transient Response

($t_r = t_f = 0.5 \mu\text{s}$, $C_1 = 0.47 \mu\text{F}$, $C_2 = 0.47 \mu\text{F}$, $I_{\text{OUT}} = 1 \text{mA} \leftrightarrow 150\text{mA}$, $T_a = 25^\circ\text{C}$)

RP130x121x

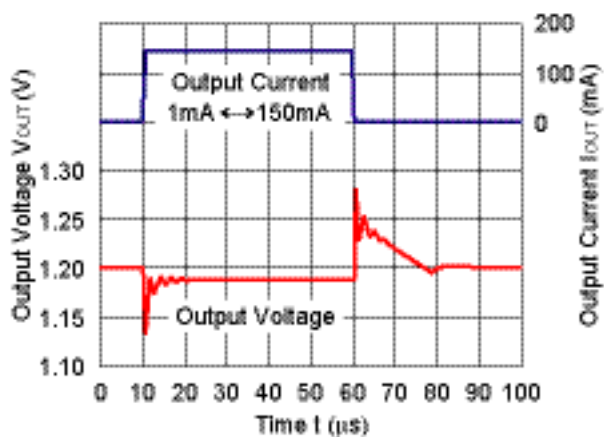

RP130x281x

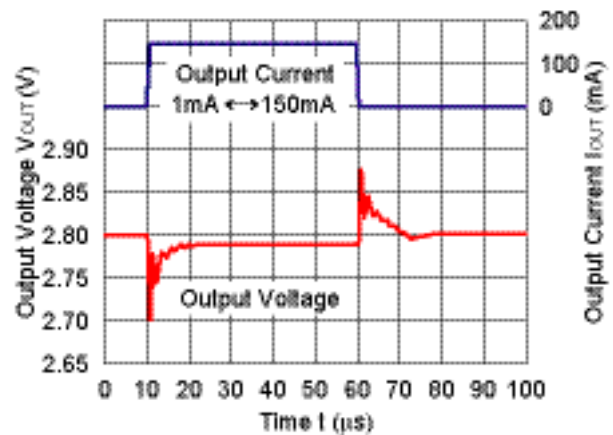

RP130x501x

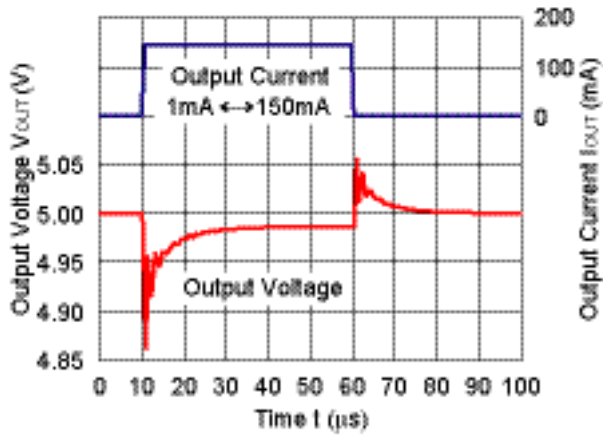

13) Turn On Speed with CE pin ($C1 = 0.47 \mu$ F, $C2 = 0.47 \mu$ F, $T_a = 25^\circ$ C)

RP130x121x

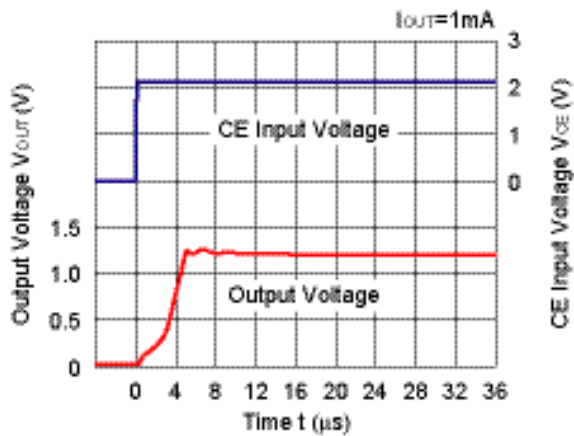

RP130x121x

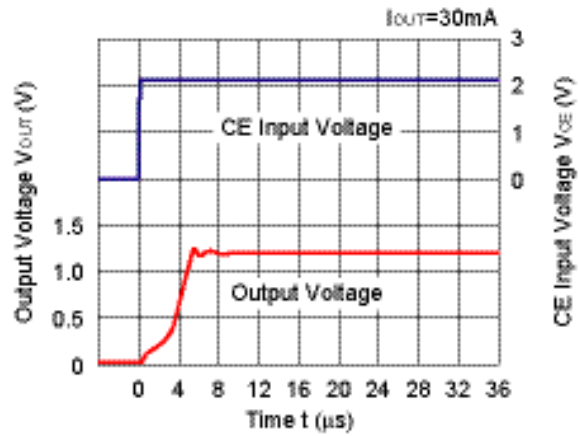

RP130x121x

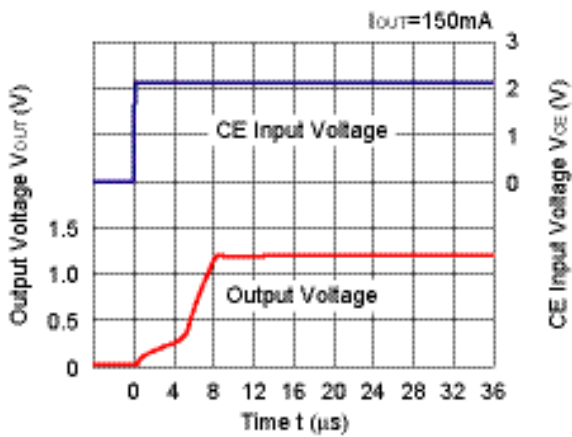

RP130x281x

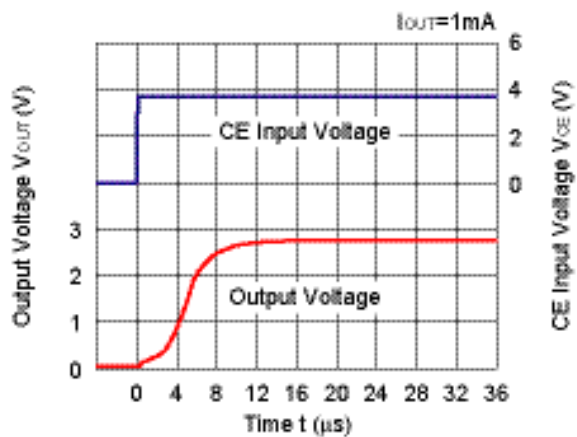

RP130x

No. EA-173-180607

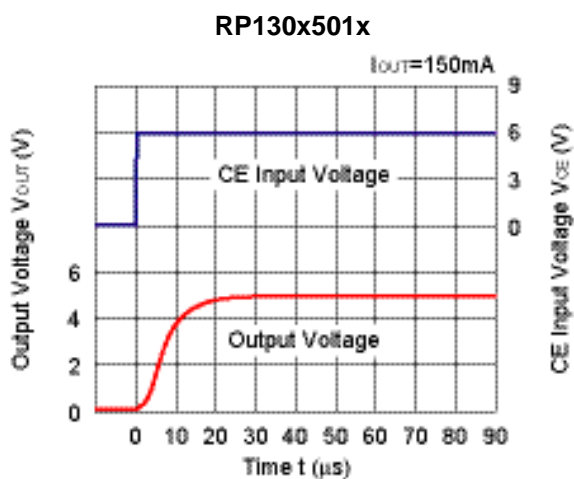
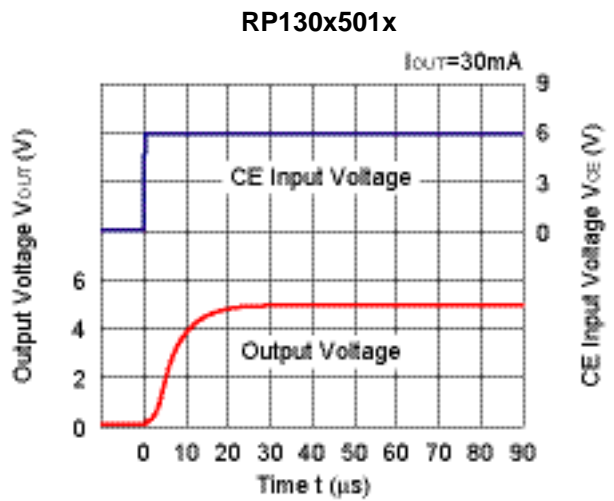
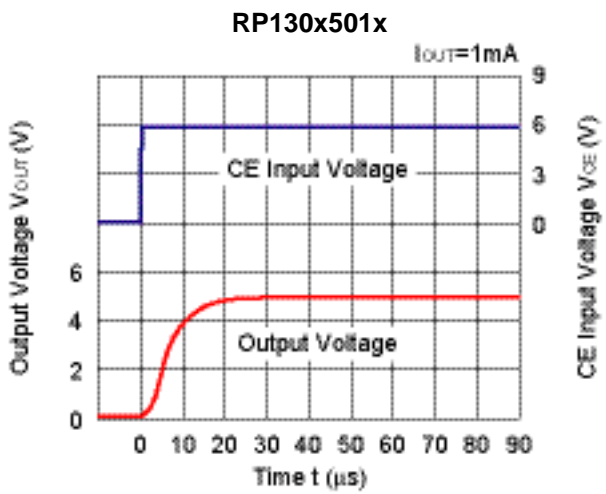
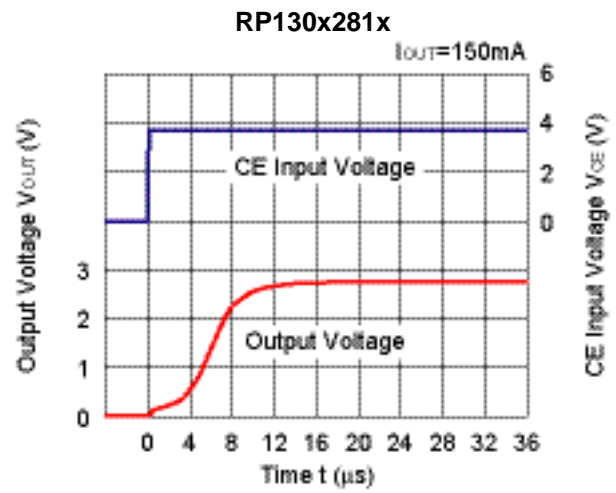
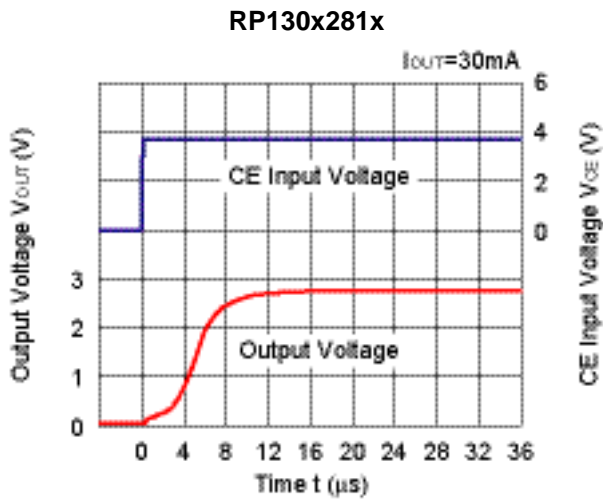

14) Turn Off Speed with CE pin (RP130xxx1D) (C1 = 0.47 μ F, C2 = 0.47 μ F, Ta = 25°C)

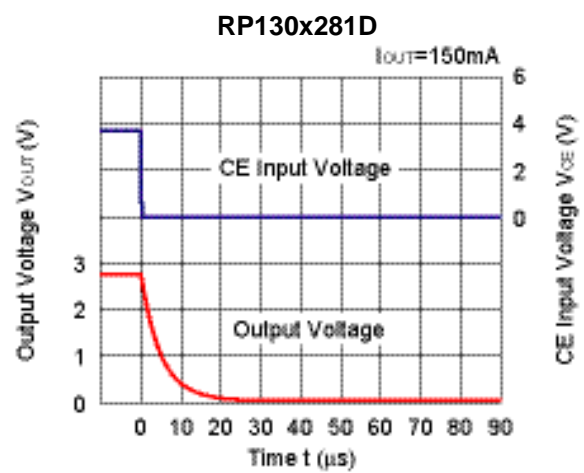
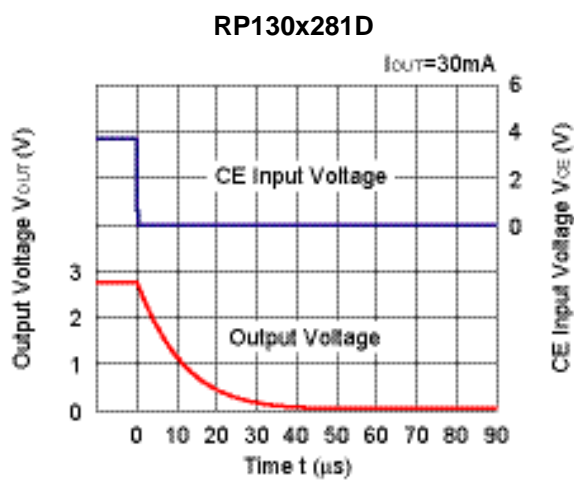
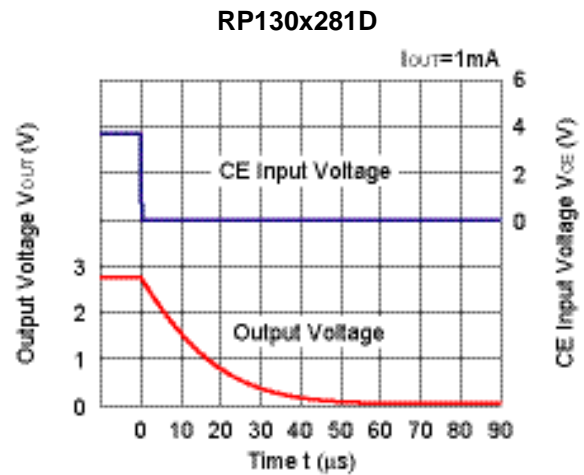
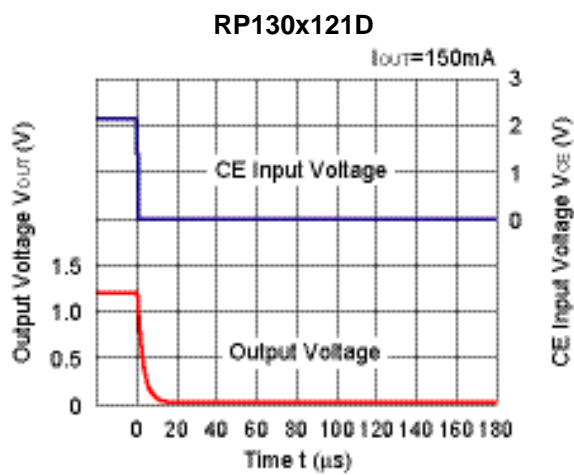
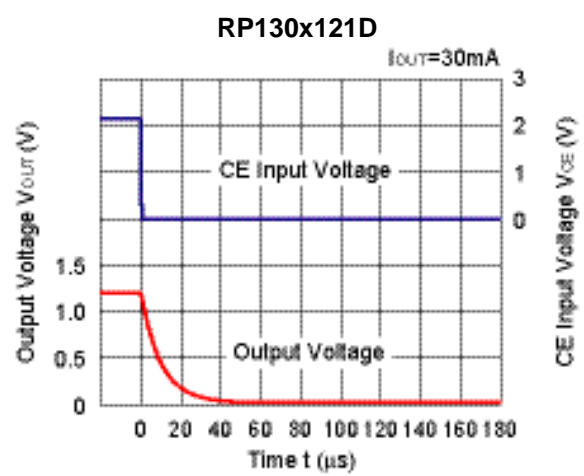
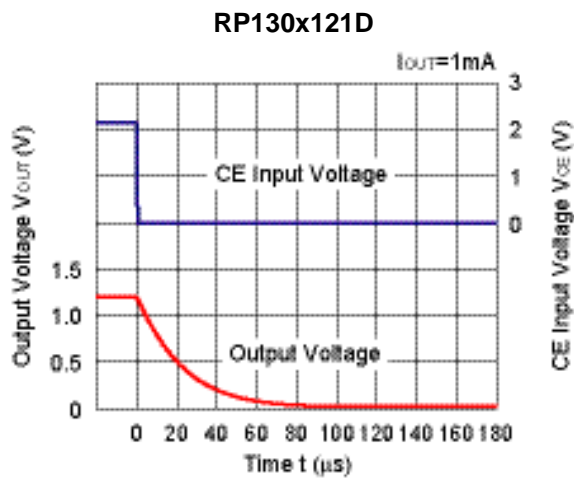

RP130x

No. EA-173-180607

RP130x501D

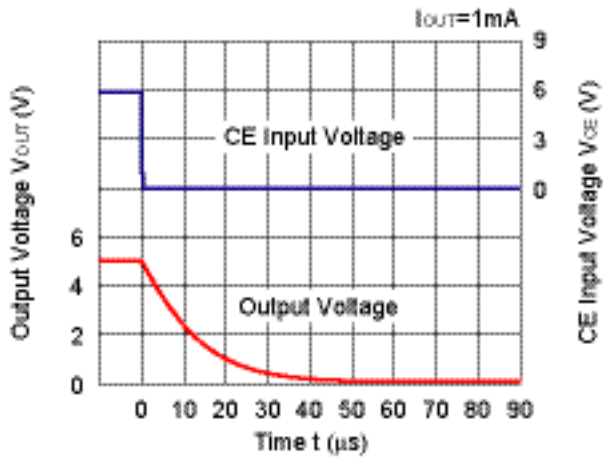

RP130x501D

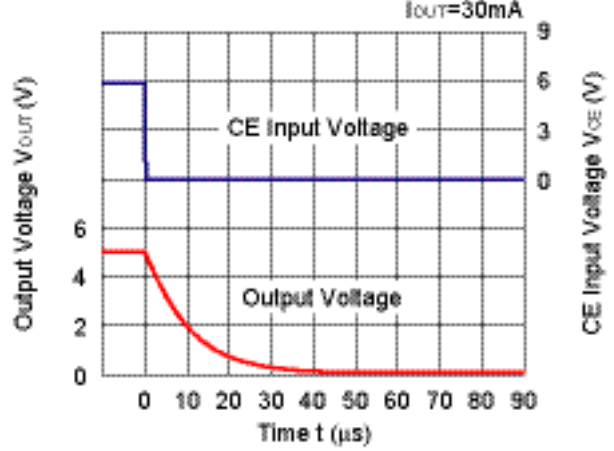

RP130x501D

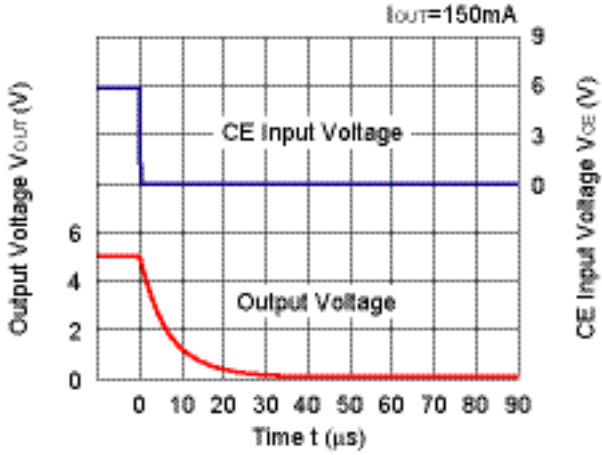

15) Minimum Operating Voltage ($C1 = 0.47 \mu F$, $C2 = 0.47 \mu F$)

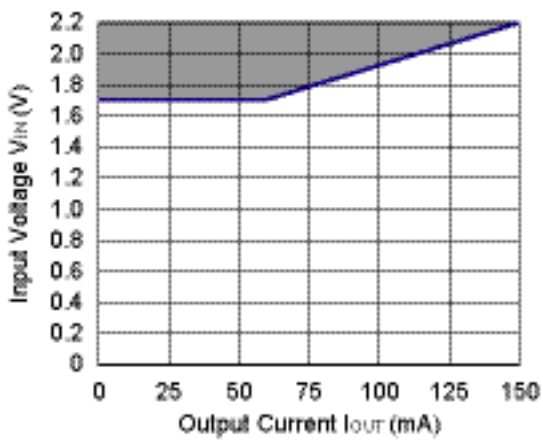

Hatched area is available for 1.2 V output.

ESR vs. Output Current

When using these ICs, consider the following points:

The relations between I_{OUT} (Output Current) and ESR of an output capacitor are shown below.

The conditions when the white noise level is under $40 \mu\text{V}$ (Avg.) are marked as the hatched area in the graph.

Measurement conditions

Frequency Band : 10 Hz to 3 MHz

Temperature : -40°C to 85°C

C1, C2 : $0.47 \mu\text{F}$

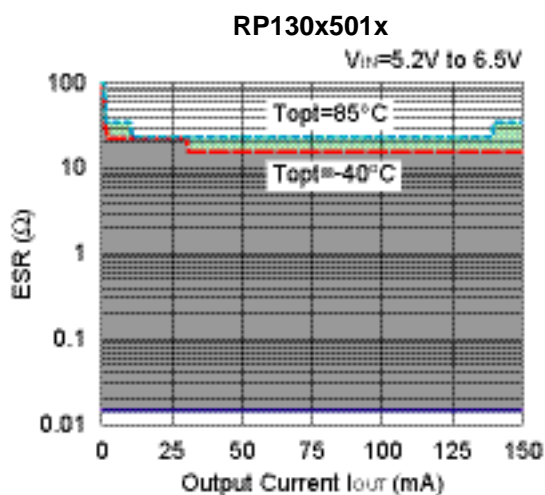
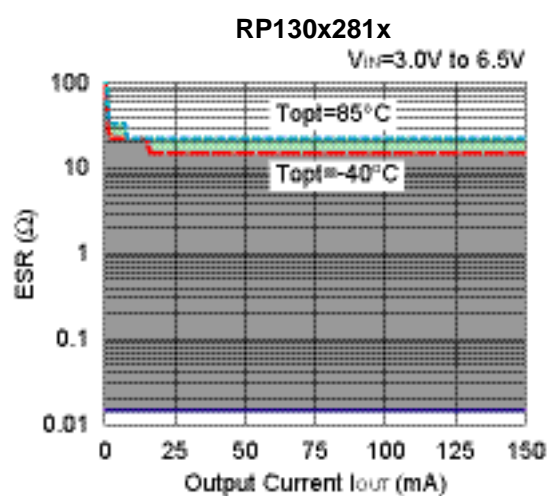
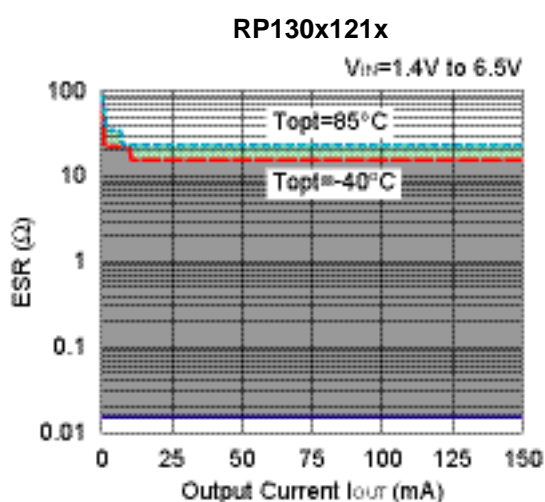

The power dissipation of the package is dependent on PCB material, layout, and environmental conditions. The following measurement conditions are based on JEDEC STD. 51-7.

Measurement Conditions

Item	Measurement Conditions
Environment	Mounting on Board (Wind Velocity = 0 m/s)
Board Material	Glass Cloth Epoxy Plastic (Four-Layer Board)
Board Dimensions	76.2 mm × 114.3 mm × 0.8 mm
Copper Ratio	Outer Layer (First Layer): Less than 95% of 50 mm Square Inner Layers (Second and Third Layers): Approx. 100% of 50 mm Square Outer Layer (Fourth Layer): Approx. 100% of 50 mm Square
Through-holes	φ 0.2 mm × 11 pcs

Measurement Result

(Ta = 25°C, Tjmax = 125°C)

Item	Measurement Result
Power Dissipation	800 mW
Thermal Resistance (θja)	θja = 125°C/W
Thermal Characterization Parameter (ψjt)	ψjt = 58°C/W

θja: Junction-to-Ambient Thermal Resistance

ψjt: Junction-to-Top Thermal Characterization Parameter

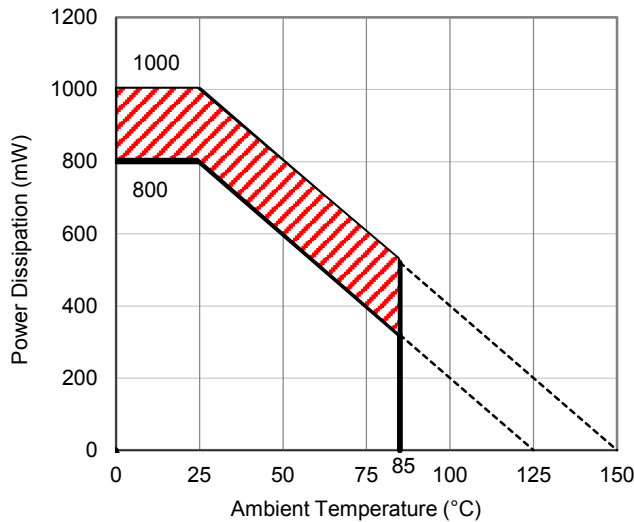

Power Dissipation vs. Ambient Temperature

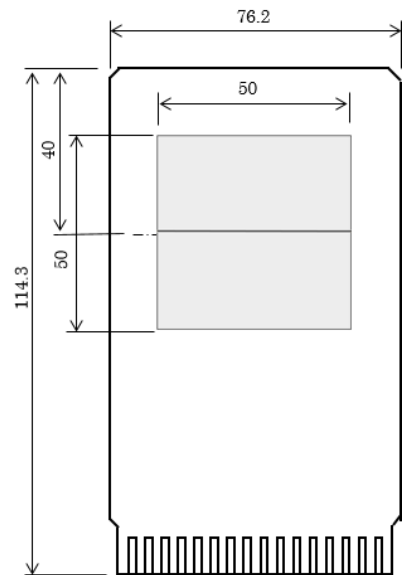

Measurement Board Pattern

The above graph shows the power dissipation of the package at Tjmax = 125°C and Tjmax = 150°C. Operating the device in the hatched range might have a negative influence on its lifetime. The total hours of use and the total years of use must be limited as follows:

Total Hours of Use	Total Years of Use (4 hours/day)
13,000 hours	9 years

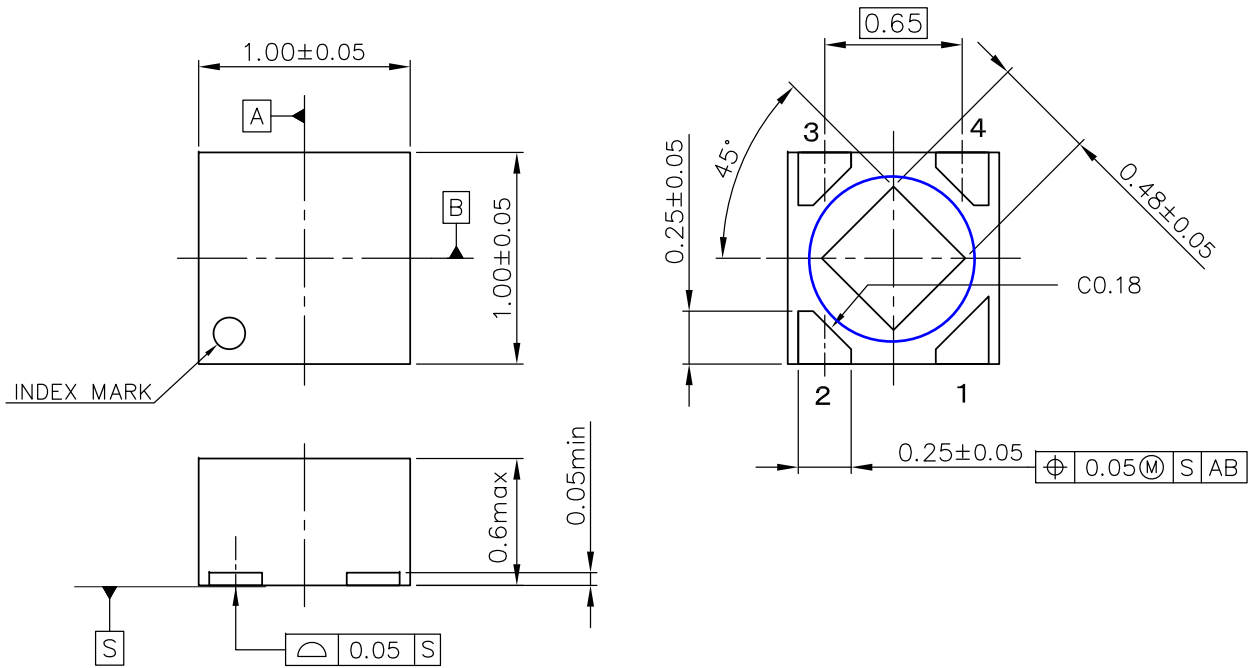

UNIT: mm

DFN(PLP)1010-4 Package Dimensions

* The tab on the bottom of the package shown by blue circle is a substrate potential (GND). It is recommended that this tab be connected to the ground plane on the board but it is possible to leave the tab floating.

The power dissipation of the package is dependent on PCB material, layout, and environmental conditions. The following conditions are used in this measurement.

Measurement Conditions

Item	Standard Land Pattern
Environment	Mounting on Board (Wind Velocity = 0 m/s)
Board Material	Glass Cloth Epoxy Plastic (Double-Sided Board)
Board Dimensions	40 mm x 40 mm x 1.6 mm
Copper Ratio	Top Side: Approx. 50% Bottom Side: Approx. 50%
Through-holes	φ 0.5 mm x 44 pcs

Measurement Result

(Ta = 25°C, Tjmax = 125°C)

Item	Standard Land Pattern
Power Dissipation	380 mW
Thermal Resistance (θja)	θja = 263°C/W

θja: Junction-to-Ambient Thermal Resistance

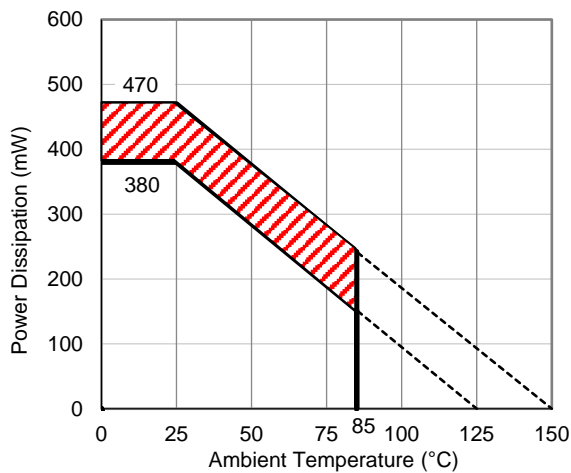

Power Dissipation vs. Ambient Temperature

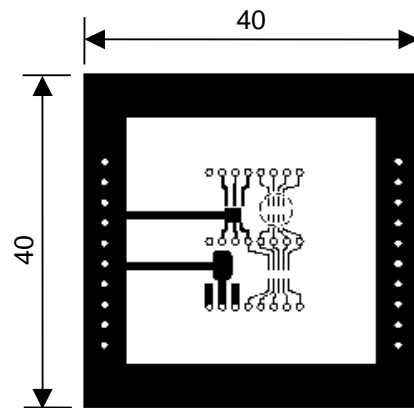

Measurement Board Pattern

The above graph shows the power dissipation of the package at Tjmax = 125°C and Tjmax = 150°C. Operating the device in the hatched range might have a negative influence on its lifetime. The total hours of use and the total years of use must be limited as follows:

Total Hours of Use	Total Years of Use (4 hours/day)
13,000 hours	9 years

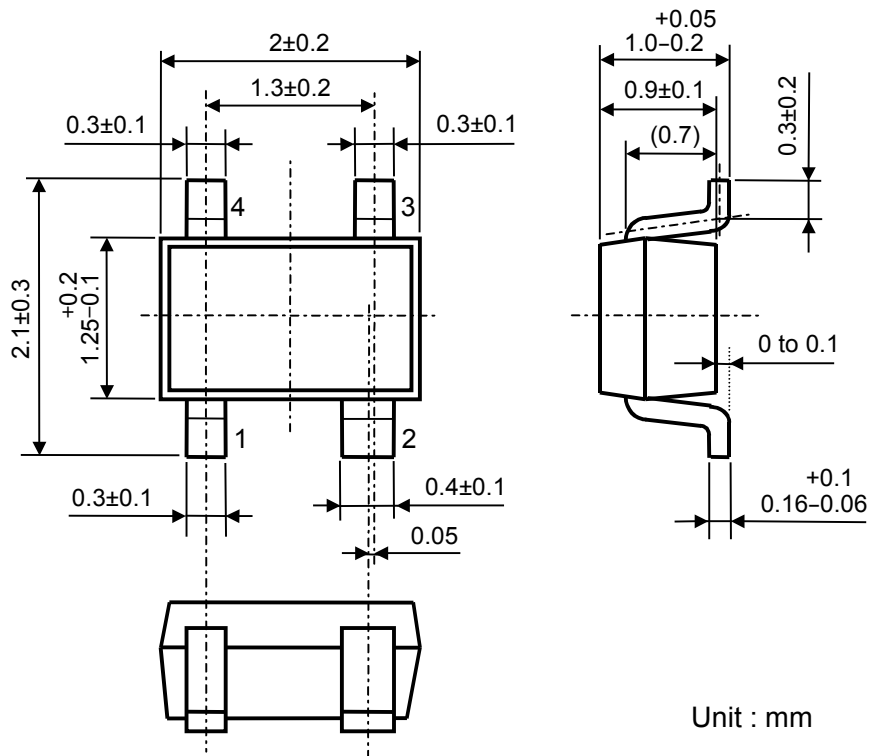

SC-82AB Package Dimensions

The power dissipation of the package is dependent on PCB material, layout, and environmental conditions. The following measurement conditions are based on JEDEC STD. 51-7.

Measurement Conditions

Item	Measurement Conditions
Environment	Mounting on Board (Wind Velocity = 0 m/s)
Board Material	Glass Cloth Epoxy Plastic (Four-Layer Board)
Board Dimensions	76.2 mm × 114.3 mm × 0.8 mm
Copper Ratio	Outer Layer (First Layer): Less than 95% of 50 mm Square Inner Layers (Second and Third Layers): Approx. 100% of 50 mm Square Outer Layer (Fourth Layer): Approx. 100% of 50 mm Square
Through-holes	φ 0.3 mm × 7 pcs

Measurement Result

(Ta = 25°C, Tjmax = 125°C)

Item	Measurement Result
Power Dissipation	660 mW
Thermal Resistance (θja)	θja = 150°C/W
Thermal Characterization Parameter (ψjt)	ψjt = 51°C/W

θja: Junction-to-Ambient Thermal Resistance

ψjt: Junction-to-Top Thermal Characterization Parameter

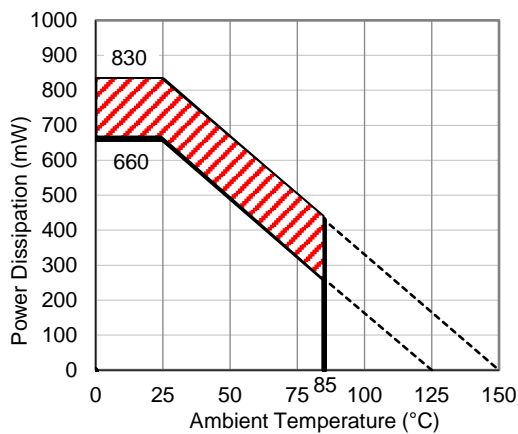

Power Dissipation vs. Ambient Temperature

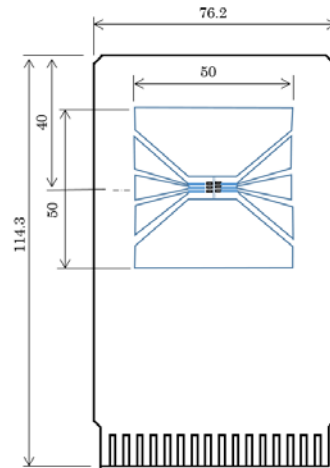

Measurement Board Pattern

The above graph shows the power dissipation of the package at Tjmax = 125°C and Tjmax = 150°C. Operating the device in the hatched range might have a negative influence on its lifetime. The total hours of use and the total years of use must be limited as follows:

Total Hours of Use	Total Years of Use (4 hours/day)
13,000 hours	9 years

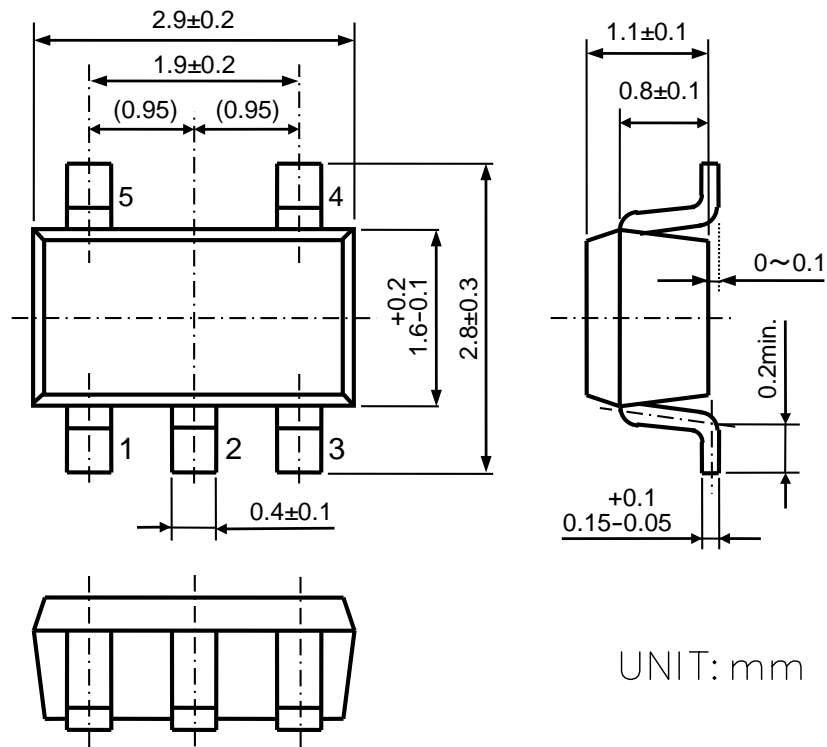

UNIT: mm

SOT-23-5 Package Dimensions



1. The products and the product specifications described in this document are subject to change or discontinuation of production without notice for reasons such as improvement. Therefore, before deciding to use the products, please refer to Ricoh sales representatives for the latest information thereon.
2. The materials in this document may not be copied or otherwise reproduced in whole or in part without prior written consent of Ricoh.
3. Please be sure to take any necessary formalities under relevant laws or regulations before exporting or otherwise taking out of your country the products or the technical information described herein.
4. The technical information described in this document shows typical characteristics of and example application circuits for the products. The release of such information is not to be construed as a warranty of or a grant of license under Ricoh's or any third party's intellectual property rights or any other rights.
5. The products listed in this document are intended and designed for use as general electronic components in standard applications (office equipment, telecommunication equipment, measuring instruments, consumer electronic products, amusement equipment etc.). Those customers intending to use a product in an application requiring extreme quality and reliability, for example, in a highly specific application where the failure or misoperation of the product could result in human injury or death (aircraft, spacevehicle, nuclear reactor control system, traffic control system, automotive and transportation equipment, combustion equipment, safety devices, life support system etc.) should first contact us.
6. We are making our continuous effort to improve the quality and reliability of our products, but semiconductor products are likely to fail with certain probability. In order to prevent any injury to persons or damages to property resulting from such failure, customers should be careful enough to incorporate safety measures in their design, such as redundancy feature, fire containment feature and fail-safe feature. We do not assume any liability or responsibility for any loss or damage arising from misuse or inappropriate use of the products.
7. Anti-radiation design is not implemented in the products described in this document.
8. The X-ray exposure can influence functions and characteristics of the products. Confirm the product functions and characteristics in the evaluation stage.
9. WLCSP products should be used in light shielded environments. The light exposure can influence functions and characteristics of the products under operation or storage.
10. There can be variation in the marking when different AOI (Automated Optical Inspection) equipment is used. In the case of recognizing the marking characteristic with AOI, please contact Ricoh sales or our distributor before attempting to use AOI.
11. Please contact Ricoh sales representatives should you have any questions or comments concerning the products or the technical information.



Ricoh is committed to reducing the environmental loading materials in electrical devices with a view to contributing to the protection of human health and the environment.

Ricoh has been providing RoHS compliant products since April 1, 2006 and Halogen-free products since April 1, 2012.

RICOH RICOH ELECTRONIC DEVICES CO., LTD.

<https://www.e-devices.ricoh.co.jp/en/>

Sales & Support Offices

Ricoh Electronic Devices Co., Ltd.

Shin-Yokohama Office (International Sales)

2-3, Shin-Yokohama 3-chome, Kohoku-ku, Yokohama-shi, Kanagawa, 222-8530, Japan
Phone: +81-50-3814-7687 Fax: +81-45-474-0074

Ricoh Americas Holdings, Inc.

675 Campbell Technology Parkway, Suite 200 Campbell, CA 95008, U.S.A.
Phone: +1-408-610-3105

Ricoh Europe (Netherlands) B.V.

Semiconductor Support Centre

Prof. W.H. Keesomlaan 1, 1183 DJ Amstelveen, The Netherlands
Phone: +31-20-5474-309

Ricoh International B.V. - German Branch

Semiconductor Sales and Support Centre

Oberrather Strasse 6, 40472 Düsseldorf, Germany
Phone: +49-211-6546-0

Ricoh Electronic Devices Korea Co., Ltd.

3F, Haesung Bldg, 504, Teheran-ro, Gangnam-gu, Seoul, 135-725, Korea
Phone: +82-2-2135-5700 Fax: +82-2-2051-5713

Ricoh Electronic Devices Shanghai Co., Ltd.

Room 403, No.2 Building, No.690 Bibo Road, Pu Dong New District, Shanghai 201203,
People's Republic of China
Phone: +86-21-5027-3200 Fax: +86-21-5027-3299

Ricoh Electronic Devices Shanghai Co., Ltd.

Shenzhen Branch

1205, Block D (Jinlong Building), Kingkey 100, Hongbao Road, Luohu District,
Shenzhen, China
Phone: +86-755-8348-7600 Ext 225

Ricoh Electronic Devices Co., Ltd.

Taipei office

Room 109, 10F-1, No.51, Hengyang Rd., Taipei City, Taiwan
Phone: +886-2-2313-1621/1622 Fax: +886-2-2313-1623

Mouser Electronics

Authorized Distributor

Click to View Pricing, Inventory, Delivery & Lifecycle Information:

Ricoh Electronics:

[RP130K501D-TR](#) [RP130N251D-TR-FE](#) [RP130N151D-TR-FE](#) [RP130N501D-TR-FE](#) [RP130N121D-TR-FE](#)
[RP130N451D-TR-FE](#) [RP130K251A-TR](#) [RP130N501B-TR-FE](#) [RP130N331B-TR-FE](#) [RP130K301D-TR](#) [RP130N251B-TR-FE](#) [RP130K121D-TR](#) [RP130N121B-TR-FE](#) [RP130K281D-TR](#) [RP130N151B-TR-FE](#) [RP130K331D-TR](#)
[RP130N331D-TR-FE](#) [RP130N451B-TR-FE](#) [RP130K451D-TR](#) [RP130N301D-TR-FE](#) [RP130K181D-TR](#) [RP130N181B-TR-FE](#) [RP130K251D-TR](#) [RP130N301B-TR-FE](#) [RP130N181D-TR-FE](#) [RP130K501B-TR](#) [RP130Q331D-TR-FE](#)
[RP130Q181D-TR-FE](#) [RP130K401D-TR](#) [RP130Q281D-TR-FE](#) [RP130Q401D-TR-FE](#) [RP130K131D-TR](#) [RP130Q501D-TR-FE](#) [RP130K181A-TR](#) [RP130Q451D-TR-FE](#) [RP130Q461D-TR-FE](#) [RP130Q471D-TR-FE](#) [RP130Q491D-TR-FE](#)
[RP130Q501B-TR-FE](#) [RP130Q271D-TR-FE](#) [RP130Q301D-TR-FE](#) [RP130Q321D-TR-FE](#) [RP130Q341D-TR-FE](#)
[RP130Q351D-TR-FE](#) [RP130Q421D-TR-FE](#) [RP130N471A-TR-FE](#) [RP130N471D-TR-FE](#) [RP130Q141D-TR-FE](#)
[RP130Q161D-TR-FE](#) [RP130Q171D-TR-FE](#) [RP130Q231D-TR-FE](#) [RP130N361D-TR-FE](#) [RP130N381D-TR-FE](#)
[RP130N411D-TR-FE](#) [RP130N421D-TR-FE](#) [RP130N441D-TR-FE](#) [RP130N461D-TR-FE](#) [RP130N301A-TR-FE](#)
[RP130N311B-TR-FE](#) [RP130N311D-TR-FE](#) [RP130N321B-TR-FE](#) [RP130N321D-TR-FE](#) [RP130N331A-TR-FE](#)
[RP130N261B-TR-FE](#) [RP130N261D-TR-FE](#) [RP130N271B-TR-FE](#) [RP130N271D-TR-FE](#) [RP130N281B-TR-FE](#)
[RP130N291D-TR-FE](#) [RP130N151A-TR-FE](#) [RP130N171D-TR-FE](#) [RP130N201D-TR-FE](#) [RP130N221B-TR-FE](#)
[RP130N221D-TR-FE](#) [RP130N241D-TR-FE](#) [RP130K341D-TR](#) [RP130K351B-TR](#) [RP130K391D-TR](#) [RP130K411D-TR](#)
[RP130K451B-TR](#) [RP130K491D-TR](#) [RP130K281B-TR](#) [RP130K281D5-TR](#) [RP130K291D-TR](#) [RP130K301B-TR](#)
[RP130K321D-TR](#) [RP130K341D5-TR](#) [RP130K211D-TR](#) [RP130K231D-TR](#) [RP130K261D-TR](#) [RP130K271B-TR](#)
[RP130K281A5-TR](#) [RP130K281A-TR](#) [RP130K151A-TR](#) [RP130K151B-TR](#) [RP130K171D-TR](#) [RP130K181B-TR](#)
[RP130K191B-TR](#) [RP130K191D-TR](#) [RP130K121A-TR](#)