

# Surface Mount Frequency Mixer

## SYM-30DMHW+

### Level 13 (LO Power +13 dBm) 5 to 3000 MHz



Generic photo used for illustration purposes only

CASE STYLE: TTT167

**+RoHS Compliant**

The +Suffix identifies RoHS Compliance. See our web site for RoHS Compliance methodologies and qualifications

Available Tape and Reel at no extra cost

Reel Size	Devices/Reel
7"	10, 20, 50, 100, 200
13"	500

### Maximum Ratings

Operating Temperature	-40°C to 85°C
Storage Temperature	-55°C to 100°C
RF Power	200mW
IF Current	40mA

Permanent damage may occur if any of these limits are exceeded.

### Pin Connections

LO	2
RF	1
IF	3
GROUND	4,5,6

### Outline Drawing

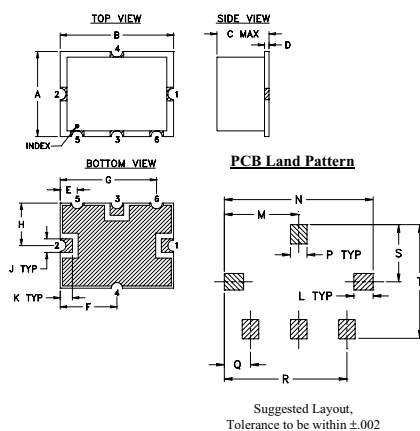

### Outline Dimensions (inch/mm)

A	B	C	D	E	F	G	H	J	K
.38	.50	.23	.020	.075	.250	.425	.187	.050	.050
9.65	12.70	5.84	0.51	1.91	6.35	10.80	4.75	1.27	1.27
L	M	N	P	Q	R	S	T	wt.	
.070	.270	.540	.060	.095	.445	.208	.415		
1.78	6.86	13.72	1.52	2.41	11.30	5.28	10.54		0.8

### Demo Board MCL P/N: TB-12 Suggested PCB Layout (PL-079)

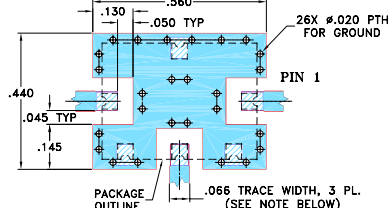

#### NOTE:

- TRACE WIDTH IS SHOWN FOR ROGERS RO4350B WITH DIELECTRIC THICKNESS .030" ± .002"; COPPER: 1/2 OZ. EACH SIDE. FOR OTHER MATERIALS TRACE WIDTH MAY NEED TO BE MODIFIED.
  - THE USE OF SOLDER MASK OVER THE GROUND AREA UNDER THE UNIT AS SHOWN IS RECOMMENDED TO PREVENT POTENTIAL SHORTING. IF USER CHOOSES TO EXPOSE METAL UNDER THE ENTIRE UNIT GROUND PAD FOR IMPROVED GROUNDING, IT IS RECOMMENDED A SOLDER MASK DAM BE APPLIED AROUND EACH GROUND PAD TO ENSURE FILLET AND CONNECTION AT GROUND PADS.
  - BOTTOM SIDE OF THE PCB IS CONTINUOUS GROUND PLANE.
- DENOTES PCB COPPER LAYOUT WITH SMOBC (SOLDER MASK OVER BARE COPPER). SEE NOTE 2.  
■ DENOTES COPPER LAND PATTERN FREE OF SOLDER MASK

#### Notes

- A. Performance and quality attributes and conditions not expressly stated in this specification document are intended to be excluded and do not form a part of this specification document.  
 B. Electrical specifications and performance data contained in this specification document are based on Mini-Circuit's applicable established test performance criteria and measurement instructions.  
 C. The parts covered by this specification document are subject to Mini-Circuits standard limited warranty and terms and conditions (collectively, "Standard Terms"); Purchasers of this part are entitled to the rights and benefits contained therein. For a full statement of the Standard Terms and the exclusive rights and remedies thereunder, please visit Mini-Circuits' website at [www.minicircuits.com/MCLStore/terms.jsp](http://www.minicircuits.com/MCLStore/terms.jsp)

### Features

- wideband, 5 to 3000 MHz
- good L-R isolation, 36 dB typ.
- excellent L-I isolation, 42 dB typ.
- triple balanced mixer

### Applications

- CDMA
- GSM
- DCS
- PCN

### Electrical Specifications

FREQUENCY (MHz)	CONVERSION LOSS* (dB)				LO-RF ISOLATION (dB)						LO-IF ISOLATION (dB)						IP3* at center band (dBm)	
	LO/RF	IF	Mid-Band m	Total Range Max.	L	M	U	L	M	U	L	M	U	L	M	U		
5-3000	5-1500	6.5	.10	8.4	9.3	36	25	39	30	34	23	41	27	42	33	45	30	22

1 dB COMP: +9 dBm typ.

\*IP3 at 800-900 MHz and 1800-1900 MHz

L = low range [ $f_1$  to  $10 f_1$ ]

m = mid band [ $2 f_1$  to  $f_1/2$ ]

M = mid range [ $10 f_1$  to  $f_1/2$ ]

U = upper range [ $f_1/2$  to  $f_1$ ]

### Typical Performance Data

Frequency (MHz)	Conversion Loss (dB)		Isolation L-R (dB)		Isolation L-I (dB)		VSWR RF Port (:1)		VSWR LO Port (:1)	
	RF	LO	LO +13dBm	LO +13dBm	LO +13dBm	LO +13dBm	LO +13dBm	LO +13dBm	LO +13dBm	LO +13dBm
5.10	35.11	6.58	36.03	38.39	1.15	1.57				
100.10	130.11	6.50	35.88	43.47	1.08	1.55				
221.15	251.16	6.49	36.20	43.04	1.13	1.54				
434.31	464.32	6.56	36.53	42.16	1.25	1.53				
647.47	677.48	6.43	37.23	40.16	1.44	1.52				
860.63	890.64	6.59	38.94	39.55	1.66	1.49				
1002.73	1032.74	6.75	40.44	39.15	1.78	1.50				
1215.89	1245.90	6.44	42.67	40.10	1.88	1.46				
1429.05	1459.06	6.20	42.49	40.48	1.74	1.43				
1500.10	1530.11	6.25	42.48	40.72	1.68	1.42				
1600.10	1630.11	6.21	41.45	40.86	1.56	1.43				
1815.49	1845.50	6.39	38.09	42.04	1.39	1.39				
1923.18	1953.19	6.74	35.83	42.77	1.41	1.37				
2030.87	2060.88	7.04	33.82	43.36	1.49	1.35				
2138.56	2168.57	7.32	31.83	43.31	1.58	1.34				
2246.25	2276.26	7.45	30.59	42.74	1.58	1.28				
2461.64	2491.65	7.42	29.50	42.49	1.41	1.19				
2677.02	2707.03	7.35	29.11	41.54	1.11	1.12				
2892.41	2922.42	7.40	29.03	38.92	1.17	1.16				
3000.10	3030.11	7.48	28.88	37.68	1.28	1.17				

### Electrical Schematic

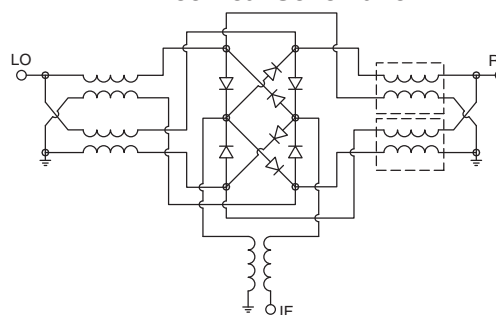

[www.minicircuits.com](http://www.minicircuits.com) P.O. Box 350166, Brooklyn, NY 11235-0003 (718) 934-4500 sales@minicircuits.com

REV. E  
M160892  
SYM-30DMHW+  
DJ/TD/AM  
200813  
Page 1 of 2

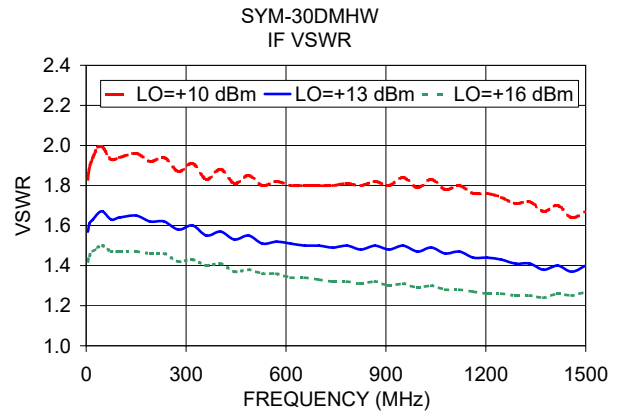
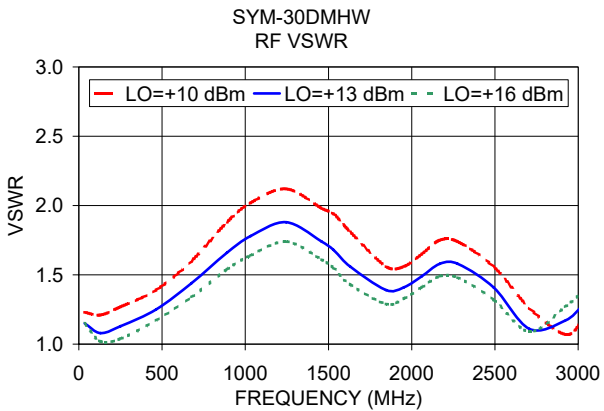
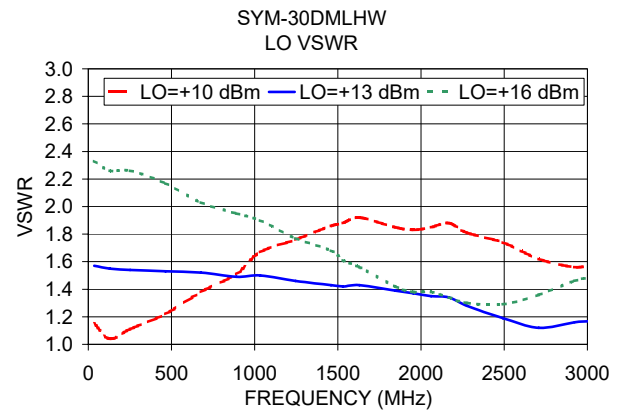
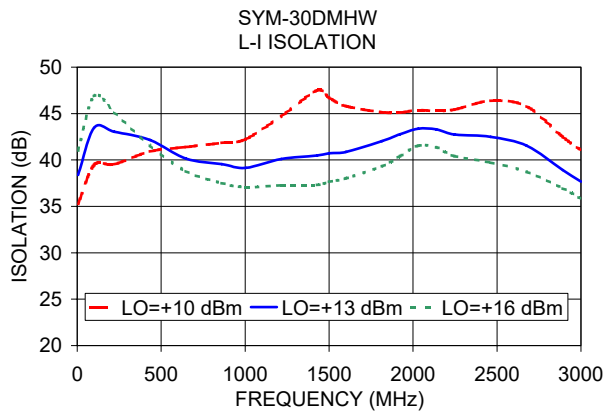
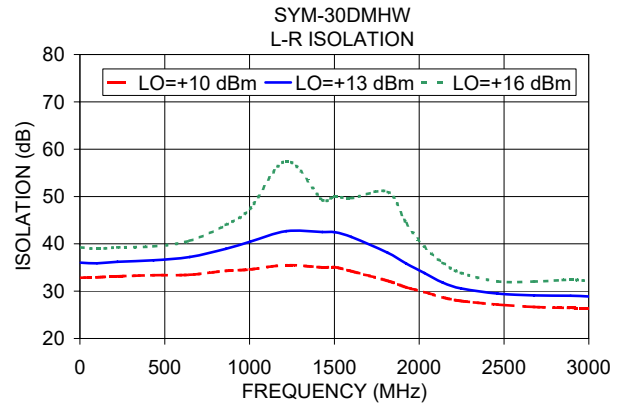
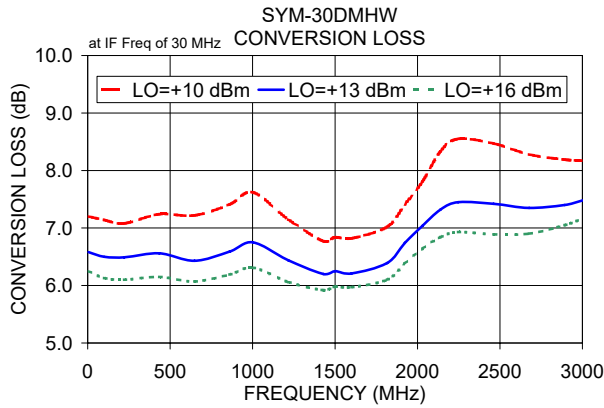

**Notes**

- A. Performance and quality attributes and conditions not expressly stated in this specification document are intended to be excluded and do not form a part of this specification document.
- B. Electrical specifications and performance data contained in this specification document are based on Mini-Circuit's applicable established test performance criteria and measurement instructions.
- C. The parts covered by this specification document are subject to Mini-Circuits standard limited warranty and terms and conditions (collectively, "Standard Terms"); Purchasers of this part are entitled to the rights and benefits contained therein. For a full statement of the Standard Terms and the exclusive rights and remedies thereunder, please visit Mini-Circuits' website at [www.minicircuits.com/MCLStore/terms.jsp](http://www.minicircuits.com/MCLStore/terms.jsp)



# Frequency Mixer

# SYM-30DMHW+

## Typical Performance Data

RF (IN) (MHz)	LO (MHz)	CONVERSION LOSS IF FIXED @IF(OUT)=30MHz (dB)			RF (IN) (MHz)	LO (MHz)	IP3 INPUT (dBm)			RF (IN) (MHz)	LO (MHz)	COMPRESSION @RF IN=+9dBm (dB)		
		@LO (dBm)					@LO (dBm)					@LO (dBm)		
		+10	+13	+16			+10	+13	+16			+10	+13	+16
5.1	35.1	7.20	6.58	6.25	10.1	40.1	25.06	26.14	25.38	10.1	40.1	0.53	0.21	0.09
8.1	38.1	7.10	6.49	6.14	110.4	140.4	21.07	23.13	23.23	110.4	140.4	0.37	0.15	0.07
10.1	40.1	7.07	6.43	6.12	210.6	240.6	19.99	20.63	21.12	210.6	240.6	0.37	0.14	0.06
50.1	80.1	6.98	6.40	6.07	310.9	340.9	18.47	19.14	21.00	310.9	340.9	0.30	0.08	0.02
110.4	140.4	7.19	6.54	6.24	411.1	441.1	17.48	19.17	21.58	411.1	441.1	0.30	0.09	0.04
210.6	240.6	7.29	6.61	6.30	511.4	541.4	17.36	20.09	22.82	511.4	541.4	0.26	0.10	0.08
310.9	340.9	7.47	6.77	6.41	611.6	641.6	16.73	20.29	24.22	611.6	641.6	0.18	0.12	0.08
411.1	441.1	7.54	6.81	6.40	711.9	741.9	17.20	21.30	25.70	711.9	741.9	0.19	0.15	0.09
511.4	541.4	7.66	6.84	6.38	812.1	842.1	17.72	22.45	25.53	812.1	842.1	0.18	0.14	0.08
611.6	641.6	7.82	6.88	6.41	912.4	942.4	18.73	22.26	23.27	912.4	942.4	0.23	0.18	0.10
711.9	741.9	7.80	6.83	6.39	1012.6	1042.6	21.31	23.80	25.53	1012.6	1042.6	0.37	0.15	0.10
812.1	842.1	7.85	6.85	6.44	1112.9	1142.9	20.80	24.36	23.86	1112.9	1142.9	0.35	0.16	0.11
912.4	942.4	7.81	6.86	6.47	1213.1	1243.1	20.67	22.02	22.75	1213.1	1243.1	0.25	0.11	0.10
1012.6	1042.6	7.76	6.87	6.52	1313.4	1343.4	19.49	20.13	21.46	1313.4	1343.4	0.32	0.13	0.12
1112.9	1142.9	7.73	6.94	6.57	1413.6	1443.6	18.89	19.90	20.54	1413.6	1443.6	0.32	0.14	0.11
1413.6	1443.6	7.65	6.83	6.52	1513.9	1543.9	18.64	19.59	20.88	1513.9	1543.9	0.35	0.16	0.11
1513.9	1543.9	7.64	6.80	6.49	1614.1	1644.1	19.54	19.48	21.05	1614.1	1644.1	0.41	0.19	0.11
1614.1	1644.1	7.66	6.76	6.46	1714.4	1744.4	21.66	20.52	21.32	1714.4	1744.4	0.37	0.18	0.11
1714.4	1744.4	7.66	6.75	6.46	1814.6	1844.6	23.10	22.32	22.28	1814.6	1844.6	0.33	0.17	0.10
1814.6	1844.6	7.77	6.83	6.51	1914.9	1944.9	22.25	25.91	24.26	1914.9	1944.9	0.25	0.13	0.08
1914.9	1944.9	8.01	6.99	6.63	2015.1	2045.1	19.88	26.15	26.83	2015.1	2045.1	0.26	0.12	0.08
2015.1	2045.1	8.17	7.18	6.79	2115.4	2145.4	18.16	23.12	29.23	2115.4	2145.4	0.17	0.09	0.08
2215.6	2245.6	8.89	7.73	7.23	2215.6	2245.6	17.11	21.83	27.52	2215.6	2245.6	0.07	0.06	0.07
2315.9	2345.9	9.18	8.01	7.43	2315.9	2345.9	17.71	22.08	25.34	2315.9	2345.9	0.01	0.04	0.07
2416.1	2446.1	9.25	7.96	7.44	2416.1	2446.1	18.54	21.20	21.81	2416.1	2446.1	0.14	0.21	0.20
2516.4	2546.4	9.03	7.80	7.26	2516.4	2546.4	17.86	19.21	19.87	2516.4	2546.4	0.41	0.39	0.35
2616.6	2646.6	8.72	7.65	7.15	2616.6	2646.6	17.09	17.88	18.23	2616.6	2646.6	0.56	0.52	0.47
2716.9	2746.9	8.57	7.60	7.15	2716.9	2746.9	15.94	16.85	17.26	2716.9	2746.9	0.69	0.59	0.52
2817.1	2847.1	8.34	7.50	7.12	2817.1	2847.1	15.08	15.98	16.51	2817.1	2847.1	0.82	0.66	0.55
2917.4	2947.4	8.27	7.45	7.12	2917.4	2947.4	14.66	15.68	16.20	2917.4	2947.4	0.87	0.65	0.54
3017.6	3047.6	8.19	7.53	7.22	3017.6	3047.6	14.23	15.16	15.94	3017.6	3047.6	0.93	0.65	0.53
3117.9	3147.9	8.24	7.63	7.35	3117.9	3147.9	14.16	15.25	16.20	3117.9	3147.9	0.90	0.59	0.47
3238.2	3268.2	8.44	7.82	7.53	3238.2	3268.2	14.03	15.11	16.62	3238.2	3268.2	0.87	0.57	0.45
3338.4	3368.4	8.66	8.09	7.79	3338.4	3368.4	13.84	15.04	16.51	3338.4	3368.4	0.82	0.51	0.39
3458.7	3488.7	9.04	8.45	8.15	3458.7	3488.7	14.07	15.62	17.67	3458.7	3488.7	0.71	0.45	0.35
3559.0	3589.0	9.41	8.81	8.47	3559.0	3589.0	14.29	16.22	18.63	3559.0	3589.0	0.66	0.40	0.31
3679.3	3709.3	9.86	9.20	8.86	3679.3	3709.3	15.30	17.72	20.15	3679.3	3709.3	0.55	0.32	0.26
3779.5	3809.5	10.28	9.62	9.23	3779.5	3809.5	16.18	18.15	20.99	3779.5	3809.5	0.50	0.26	0.23
3899.8	3929.8	10.80	10.10	9.72	3899.8	3929.8	18.19	19.39	22.00	3899.8	3929.8	0.48	0.20	0.16
4000.1	4030.1	11.24	10.53	10.13	4000.1	4030.1	20.37	20.33	21.94	4000.1	4030.1	0.56	0.21	0.16

# Frequency Mixer

# SYM-30DMHW+

## Typical Performance Data

IF (OUT) (MHz)	LO (MHz)	CONVERSION LOSS VS. IF FREQUENCY @RF(IN)=1500.1MHz (dB)	IF (OUT) (MHz)	LO (MHz)	CONVERSION LOSS VS. IF FREQUENCY @RF(IN)=10.1MHz (dB)	IF (OUT) (MHz)	LO (MHz)	CONVERSION LOSS VS. IF FREQUENCY @RF(IN)=3000.1MHz (dB)
		@LO (dBm)			@LO (dBm)			@LO (dBm)
		+13			+13			+13
1490.0	10.1	7.32	10.0	20.1	6.42	1500.0	1500.1	7.76
1449.5	50.6	7.41	50.8	60.9	6.33	1460.3	1539.8	7.87
1408.9	91.2	7.49	91.6	101.7	6.35	1420.5	1579.6	7.89
1368.4	131.7	7.37	132.5	142.6	6.29	1380.8	1619.3	7.91
1327.8	172.3	7.47	173.3	183.4	6.44	1341.1	1659.0	7.96
1287.3	212.8	7.53	214.1	224.2	6.35	1301.3	1698.8	7.96
1246.7	253.4	7.49	254.9	265.0	6.41	1261.6	1738.5	7.99
1206.2	293.9	7.58	295.8	305.9	6.41	1221.9	1778.2	7.99
1165.6	334.5	7.52	336.6	346.7	6.36	1182.1	1818.0	8.01
1125.1	375.0	7.41	377.4	387.5	6.42	1142.4	1857.7	8.03
1084.5	415.6	7.61	418.2	428.3	6.38	1102.7	1897.4	7.99
1044.0	456.1	7.58	459.0	469.1	6.41	1062.9	1937.2	8.01
1003.4	496.7	7.54	499.9	510.0	6.39	1023.2	1976.9	7.94
962.9	537.2	7.52	540.7	550.8	6.40	983.5	2016.6	7.92
922.3	577.8	7.51	581.5	591.6	6.39	943.7	2056.4	7.89
881.8	618.3	7.42	622.3	632.4	6.36	904.0	2096.1	7.82
841.2	658.9	7.46	663.2	673.3	6.45	864.3	2135.8	7.82
800.7	699.4	7.39	704.0	714.1	6.46	824.5	2175.6	7.74
760.1	740.0	7.33	744.8	754.9	6.46	784.8	2215.3	7.69
719.6	780.5	7.34	785.6	795.7	6.46	745.1	2255.0	7.64
679.0	821.1	7.24	826.4	836.5	6.48	705.3	2294.8	7.55
638.5	861.6	7.21	867.3	877.4	6.53	665.6	2334.5	7.55
597.9	902.2	7.24	908.1	918.2	6.50	625.9	2374.2	7.44
557.4	942.7	7.21	948.9	959.0	6.52	586.1	2414.0	7.38
516.8	983.3	7.16	989.7	999.8	6.57	546.4	2453.7	7.31
476.3	1023.8	7.14	1030.5	1040.6	6.57	506.7	2493.4	7.21
435.8	1064.3	7.16	1071.4	1081.5	6.62	466.9	2533.2	7.21
395.2	1104.9	7.14	1112.2	1122.3	6.63	427.2	2572.9	7.16
354.7	1145.4	7.12	1153.0	1163.1	6.67	387.5	2612.6	7.15
314.1	1186.0	7.07	1193.8	1203.9	6.70	347.7	2652.4	7.11
273.6	1226.5	7.00	1234.7	1244.8	6.74	308.0	2692.1	7.12
253.3	1246.8	7.01	1255.1	1265.2	6.73	268.3	2731.8	7.17
212.7	1287.4	6.96	1295.9	1306.0	6.74	228.5	2771.6	7.16
192.5	1307.6	6.93	1316.3	1326.4	6.70	188.8	2811.3	7.19
151.9	1348.2	6.89	1357.1	1367.2	6.74	149.1	2851.0	7.22
131.6	1368.5	6.88	1377.5	1387.6	6.72	129.2	2870.9	7.21
91.1	1409.0	6.78	1418.4	1428.5	6.77	89.5	2910.6	7.27
70.8	1429.3	6.81	1438.8	1448.9	6.78	69.6	2930.5	7.29
30.3	1469.8	6.76	1479.6	1489.7	6.82	29.9	2970.2	7.35
10.0	1490.1	6.84	1500.0	1510.1	6.83	10.0	2990.1	7.46



# Frequency Mixer

# SYM-30DMHW+

## Typical Performance Data

LO (MHz)	LO-RF ISOLATION (dB)			LO-IF ISOLATION (dB)		
	@LO (dBm)			@LO (dBm)		
	+10	+13	+16	+10	+13	+16
5.1	32.84	36.03	39.25	35.27	38.39	41.02
8.1	33.26	36.24	39.38	36.96	40.31	43.23
10.1	33.21	36.18	39.20	37.54	41.08	44.12
50.1	32.80	35.70	38.66	39.55	43.60	47.30
110.4	31.88	34.41	36.76	40.15	44.28	47.78
210.6	31.91	34.46	36.66	40.56	44.55	47.32
310.9	32.09	34.55	36.55	41.15	45.13	46.41
411.1	32.08	34.46	36.24	42.23	45.83	45.33
511.4	32.26	34.57	36.42	43.47	45.85	44.14
611.6	32.30	34.58	36.42	44.96	45.98	43.20
711.9	32.57	35.10	37.23	46.48	45.91	42.39
812.1	32.81	35.42	37.79	48.10	44.85	41.35
912.4	33.28	36.16	38.88	49.44	44.67	41.05
1012.6	34.05	37.50	40.66	51.14	44.99	41.13
1112.9	34.92	38.68	42.37	53.74	46.43	41.67
1413.6	35.67	40.12	46.31	47.71	53.49	44.66
1513.9	35.30	40.17	47.72	44.22	51.50	45.90
1614.1	34.80	39.82	47.68	42.50	49.72	48.01
1714.4	33.93	38.78	46.18	41.37	48.10	51.17
1814.6	33.27	37.38	43.87	40.74	47.18	56.26
1914.9	32.65	35.93	40.64	39.98	44.93	55.47
2015.1	32.27	34.68	37.84	39.40	43.02	50.03
2215.6	31.63	32.71	34.06	38.98	41.51	45.99
2315.9	31.21	31.93	32.79	39.07	41.51	45.40
2416.1	30.73	31.55	32.52	39.11	41.83	45.52
2516.4	30.34	31.27	32.65	39.51	42.53	46.05
2616.6	30.20	31.13	32.59	39.82	42.95	45.76
2716.9	30.18	31.35	33.01	40.21	43.09	44.18
2817.1	30.49	32.02	33.97	40.52	42.82	42.29
2917.4	30.80	32.60	34.91	41.37	41.95	40.68
3017.6	31.24	33.56	36.16	41.58	40.89	38.65
3117.9	31.99	34.66	37.28	41.01	39.45	37.09
3238.2	33.39	36.60	37.89	39.42	37.38	35.21
3338.4	34.34	37.53	36.72	37.96	35.68	33.90
3458.7	35.46	37.51	34.77	36.27	34.37	32.98
3559.0	36.15	36.90	33.62	34.88	33.31	32.13
3679.3	36.65	35.32	32.60	33.24	31.93	31.27
3779.5	36.38	34.30	32.08	31.99	31.16	30.75
3899.8	35.15	33.31	31.56	30.32	30.07	29.85
4000.1	33.93	32.53	31.28	29.01	28.96	28.92

RF (IN) (MHz)	LO (MHz)	RF-IF ISOLATION (dB)		
		@LO (dBm)		
		+10	+13	+16
10.1	40.1	31.69	31.72	31.55
110.4	140.4	32.80	32.93	32.83
210.6	240.6	33.42	33.80	34.20
310.9	340.9	34.29	34.64	34.78
411.1	441.1	35.38	35.75	36.15
511.4	541.4	36.49	36.84	36.57
611.6	641.6	38.02	38.20	37.71
711.9	741.9	39.72	39.17	38.75
812.1	842.1	42.14	40.92	39.92
912.4	942.4	43.07	41.52	40.12
1012.6	1042.6	41.52	40.92	40.68
1112.9	1142.9	40.86	40.99	41.34
1213.1	1243.1	40.70	41.28	41.64
1313.4	1343.4	40.26	40.74	40.48
1413.6	1443.6	39.51	39.49	39.33
1513.9	1543.9	38.66	38.14	37.69
1614.1	1644.1	37.36	37.05	36.51
1714.4	1744.4	36.47	36.18	36.02
1814.6	1844.6	36.30	36.51	36.23
1914.9	1944.9	36.83	37.47	37.57
2015.1	2045.1	36.91	37.90	37.86
2115.4	2145.4	36.01	36.35	36.36
2215.6	2245.6	34.70	34.61	34.65
2315.9	2345.9	33.25	33.04	32.84
2416.1	2446.1	31.88	31.45	31.20
2516.4	2546.4	30.61	30.09	29.83
2616.6	2646.6	29.61	29.18	28.92
2716.9	2746.9	28.77	28.43	28.27
2817.1	2847.1	28.03	27.79	27.79
2917.4	2947.4	27.43	27.30	27.40
3017.6	3047.6	26.91	26.82	26.82
3117.9	3147.9	26.72	26.81	26.77
3238.2	3268.2	26.38	26.73	26.83
3338.4	3368.4	26.15	26.50	26.49
3458.7	3488.7	26.14	26.44	26.47
3559.0	3589.0	26.32	26.75	26.85
3679.3	3709.3	26.64	27.20	27.50
3779.5	3809.5	26.76	27.41	27.74
3899.8	3929.8	27.18	27.84	28.12
4000.1	4030.1	27.81	28.38	28.64

# Frequency Mixer

# SYM-30DMHW+

## Typical Performance Data

RF (IN) (MHz)	LO (MHz)	RF VSWR (:1)			LO (MHz)	LO VSWR (:1)			IF (OUT) (MHz)	IF VSWR @LO=3000.1MHz (:1)		
		@LO (dBm)				@LO (dBm)				@LO (dBm)		
		+10	+13	+16		+10	+13	+16		+10	+13	+16
5.1	35.1	1.23	1.15	1.15	5.1	1.15	1.57	2.33	5.1	1.83	1.57	1.42
8.1	38.1	1.21	1.11	1.10	8.1	1.10	1.57	2.30	10.1	1.89	1.61	1.45
10.1	40.1	1.20	1.09	1.08	10.1	1.08	1.56	2.32	49.7	1.74	1.47	1.32
50.1	80.1	1.19	1.06	1.06	50.1	1.03	1.56	2.31	89.5	1.76	1.48	1.34
110.4	140.4	1.21	1.07	1.04	110.4	1.08	1.53	2.20	129.2	1.80	1.51	1.36
210.6	240.6	1.26	1.13	1.06	210.6	1.18	1.54	2.18	168.9	1.78	1.50	1.35
310.9	340.9	1.35	1.21	1.14	310.9	1.23	1.55	2.20	208.7	1.76	1.48	1.33
411.1	441.1	1.44	1.30	1.22	411.1	1.35	1.53	2.09	248.4	1.80	1.51	1.35
511.4	541.4	1.55	1.40	1.30	511.4	1.43	1.50	2.01	288.1	1.80	1.51	1.36
611.6	641.6	1.71	1.53	1.42	611.6	1.53	1.51	1.96	327.9	1.80	1.51	1.35
711.9	741.9	1.85	1.64	1.53	711.9	1.63	1.49	1.88	367.6	1.86	1.56	1.40
812.1	842.1	2.00	1.77	1.65	812.1	1.74	1.47	1.79	407.3	1.84	1.55	1.39
912.4	942.4	2.15	1.90	1.76	912.4	1.87	1.49	1.71	447.1	1.86	1.57	1.39
1012.6	1042.6	2.23	1.96	1.82	1012.6	2.02	1.51	1.64	486.8	1.88	1.59	1.41
1112.9	1142.9	2.34	2.08	1.94	1112.9	2.16	1.55	1.57	526.5	1.83	1.54	1.37
1213.1	1243.1	2.47	2.20	2.05	1213.1	2.32	1.58	1.50	566.3	1.86	1.55	1.38
1413.6	1443.6	2.54	2.22	2.04	1413.6	2.55	1.64	1.36	606.0	1.89	1.58	1.40
1513.9	1543.9	2.54	2.19	2.01	1513.9	2.62	1.65	1.30	645.7	1.87	1.56	1.37
1614.1	1644.1	2.52	2.13	1.94	1614.1	2.63	1.64	1.23	685.5	1.94	1.61	1.41
1714.4	1744.4	2.46	2.04	1.85	1714.4	2.61	1.62	1.17	725.2	1.95	1.62	1.42
1814.6	1844.6	2.37	2.00	1.79	1814.6	2.57	1.59	1.11	764.9	1.93	1.60	1.40
1914.9	1944.9	2.36	2.00	1.81	1914.9	2.51	1.55	1.07	804.7	2.03	1.67	1.46
2015.1	2045.1	2.35	2.04	1.87	2015.1	2.44	1.52	1.09	844.4	2.00	1.65	1.44
2215.6	2245.6	2.39	2.15	2.02	2215.6	2.29	1.47	1.23	884.1	2.01	1.66	1.45
2315.9	2345.9	2.39	2.18	2.04	2315.9	2.20	1.46	1.31	923.9	2.10	1.73	1.50
2416.1	2446.1	2.33	2.10	1.99	2416.1	2.10	1.45	1.39	963.6	2.05	1.69	1.47
2516.4	2546.4	2.14	1.94	1.83	2516.4	1.99	1.43	1.46	1003.3	2.09	1.71	1.49
2616.6	2646.6	1.90	1.74	1.64	2616.6	1.88	1.42	1.53	1043.1	2.12	1.73	1.51
2716.9	2746.9	1.70	1.56	1.48	2716.9	1.77	1.41	1.60	1082.8	2.03	1.67	1.45
2817.1	2847.1	1.53	1.41	1.36	2817.1	1.66	1.42	1.67	1122.5	2.08	1.70	1.48
2917.4	2947.4	1.38	1.29	1.26	2917.4	1.56	1.44	1.75	1162.3	2.10	1.71	1.48
3017.6	3047.6	1.24	1.21	1.24	3017.6	1.47	1.47	1.82	1202.0	2.03	1.66	1.44
3117.9	3147.9	1.17	1.22	1.31	3117.9	1.40	1.51	1.90	1241.7	2.07	1.69	1.47
3238.2	3268.2	1.20	1.34	1.46	3238.2	1.32	1.54	1.96	1281.5	2.02	1.65	1.43
3338.4	3368.4	1.30	1.47	1.62	3338.4	1.29	1.59	2.01	1321.2	1.95	1.60	1.39
3458.7	3488.7	1.47	1.66	1.83	3458.7	1.30	1.66	2.09	1360.9	1.97	1.62	1.41
3559.0	3589.0	1.64	1.84	2.03	3559.0	1.35	1.74	2.18	1380.8	1.95	1.60	1.40
3679.3	3709.3	1.87	2.12	2.30	3679.3	1.44	1.85	2.30	1420.5	1.83	1.51	1.32
3779.5	3809.5	2.08	2.33	2.51	3779.5	1.52	1.95	2.40	1440.4	1.83	1.52	1.33
3899.8	3929.8	2.33	2.58	2.75	3899.8	1.65	2.08	2.54	1480.1	1.84	1.52	1.34
4000.1	4030.1	2.55	2.77	2.95	4000.1	1.77	2.19	2.65	1500.0	1.80	1.49	1.30

## Harmonics Tables

RF HARMONICS ORDER

	(-dBm)	(-dBc)										
0	-	-	11	13	21	18	30	30	28	44	43	44
1	-	53	+0	44	16	48	28	42	44	42	46	50
2	>100	49	56	54	61	53	75	58	61	68	64	71
3	>100	>87	62	>87	66	80	64	>87	72	74	74	78
4	>100	>87	>87	>87	>87	>87	>87	>87	>87	>87	>87	>87
5	>100	>87	>87	>87	>87	>87	>87	>87	>87	>87	>87	>87
6	>100	>87	>87	>87	>87	>87	>87	>87	>87	>87	>87	>87
7	>100	>87	>87	>87	>87	>87	>87	>87	>87	>87	>87	>87
8	>100	>87	>87	>87	>87	>87	>87	>87	>87	>87	>87	>87
9	>100	>87	>87	>87	>87	>87	>87	>87	>87	>87	>87	>87
10	>100	>87	>87	>87	>87	>87	>87	>87	>87	>87	>87	>87
	RF CAL	0	1	2	3	4	5	6	7	8	9	10

### LO HARMONICS ORDER

Test conditions: RF IN: 1500.1 MHz; -6.00 dBm.  
 LO IN: 1530.01 MHz; +13.00 dBm  
 IF OUT: 29.91 MHz; -13.12 dBm

RF HARMONICS ORDER

	(-dBm)	(-dBc)										
0	-	-	21	23	32	29	39	41	39	54	64	75
1	-	51	+0	43	16	47	29	44	44	45	51	54
2	>100	40	46	45	52	44	67	53	57	68	59	71
3	>100	70	42	69	48	66	47	78	58	58	59	60
4	>100	76	74	62	74	65	72	64	80	68	69	72
5	>100	83	77	82	63	85	64	77	64	87	68	73
6	>100	>97	90	88	89	76	90	75	84	72	>97	78
7	>100	93	93	90	91	94	83	93	84	87	81	91
8	>100	>97	>97	>97	>97	>97	>97	90	>97	92	>97	87
9	>100	>97	>97	>97	>97	>97	>97	>97	>97	>97	95	>97
10	>100	>97	>97	>97	>97	>97	>97	>97	>97	>97	>97	96
	RF CAL	0	1	2	3	4	5	6	7	8	9	10

### LO HARMONICS ORDER

Test conditions: RF IN: 1500.1 MHz; 4.00 dBm.  
 LO IN: 1530.01 MHz; +13.00 dBm  
 IF OUT: 29.91 MHz; -3.19 dBm

- Notes: 1. All Harmonics are in (dBc) relative to IF OUTPUT.  
 2. + entry denotes harmonics are in (dBc) above IF OUTPUT.  
 3. RF Cal represent the Harmonics level of the RF input signal to the mixer.

REV. X2  
 SYM-30DMHW+  
 100818  
 Page 5 of 5



IF/RF MICROWAVE COMPONENTS • ISO 9001 ISO 14001 AS 9100 CERTIFIED • RoHS compliant  
 P.O. Box 350166, Brooklyn, New York 11235-0006 (718) 934-4500 Fax (718) 332-4661



The Design Engineers Search Engine finds the model you need, Instantly • For detailed performance specs & shopping online see





# Frequency Mixer

# SYM-30DMHW+

## Typical Performance Curves

Conversion Loss @ IF=30MHz

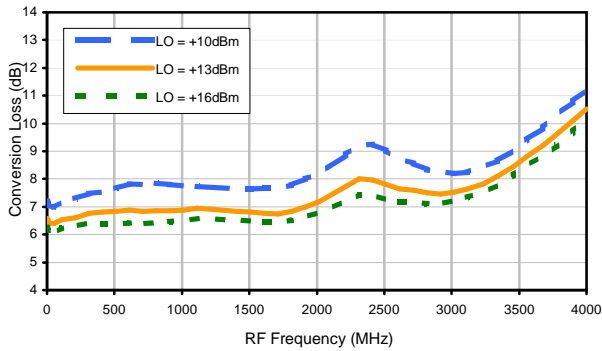

Conversion Loss vs. IF @ RF=1500.1MHz

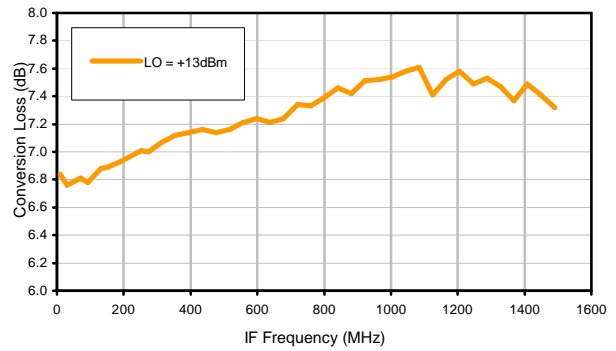

Conversion Loss vs. IF @ RF=10.1MHz

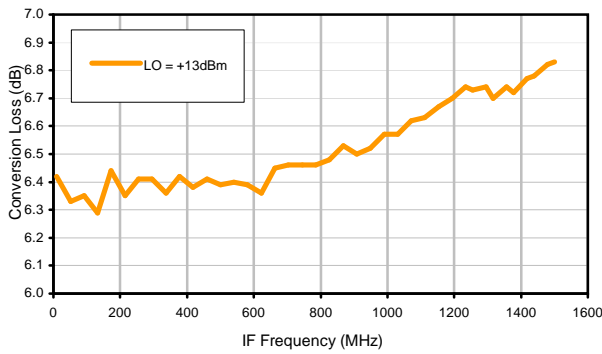

Conversion Loss vs. IF @ RF=3000.1MHz

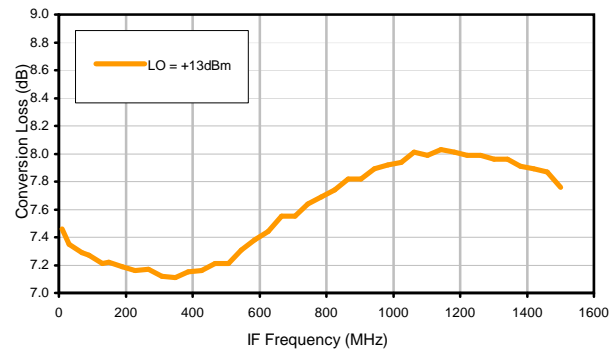

IP3 Input

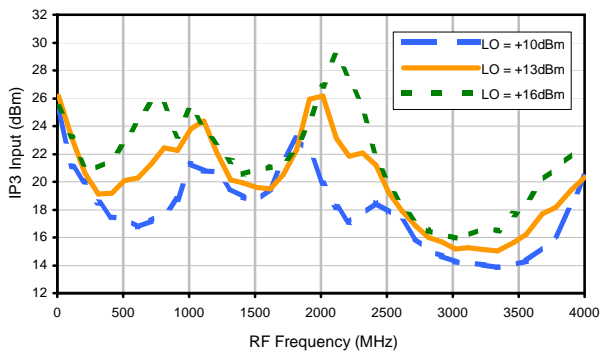

Compression @ RF IN=+9dBm

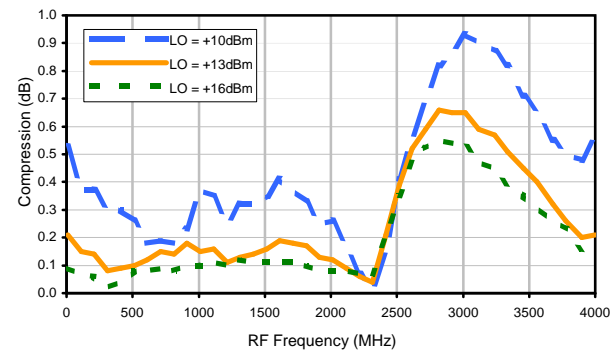



## Typical Performance Curves

LO-RF Isolation

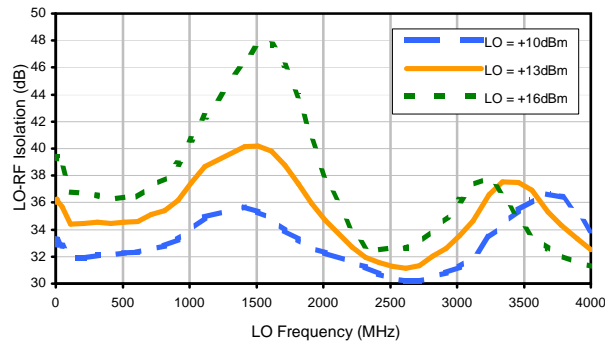

LO-IF Isolation

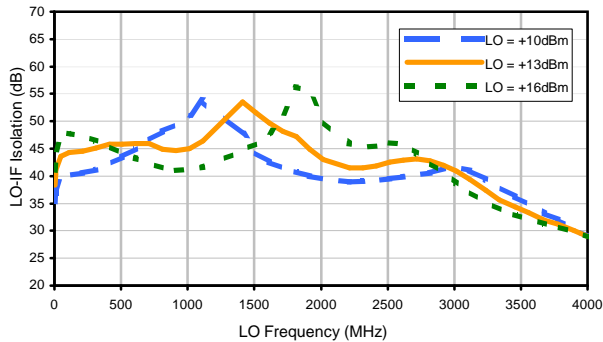

RF-IF Isolation

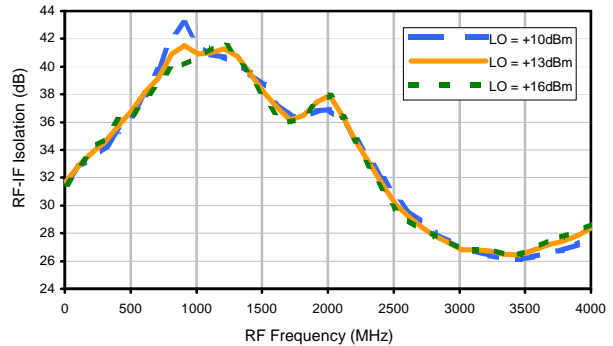

RF VSWR

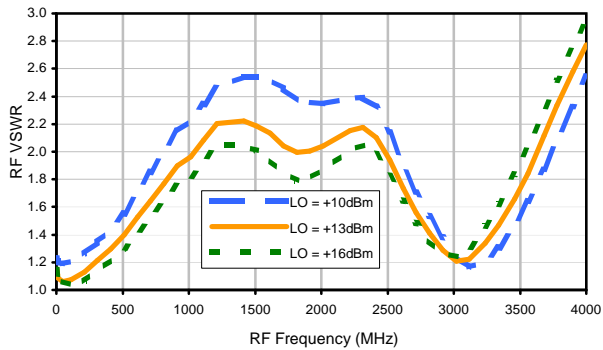

LO VSWR

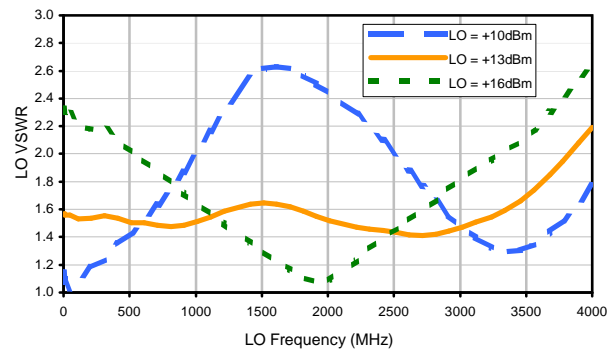

IF VSWR

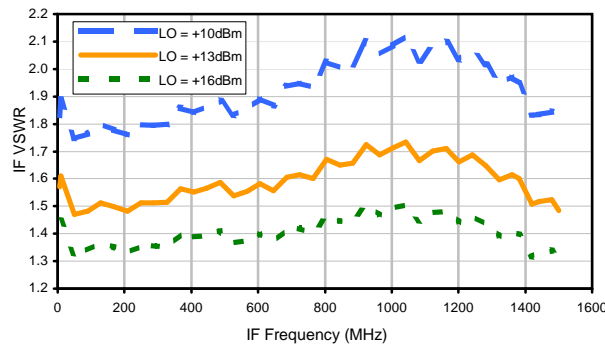

## Harmonics Tables

RF HARMONICS ORDER

	(-dBm)	(-dBc)										
0	-	-	11	13	21	18	30	30	28	44	43	44
1	-	53	+0	44	16	48	28	42	44	42	46	50
2	>100	49	56	54	61	53	75	58	61	68	64	71
3	>100	>87	62	>87	66	80	64	>87	72	74	74	78
4	>100	>87	>87	>87	>87	>87	>87	>87	>87	>87	>87	>87
5	>100	>87	>87	>87	>87	>87	>87	>87	>87	>87	>87	>87
6	>100	>87	>87	>87	>87	>87	>87	>87	>87	>87	>87	>87
7	>100	>87	>87	>87	>87	>87	>87	>87	>87	>87	>87	>87
8	>100	>87	>87	>87	>87	>87	>87	>87	>87	>87	>87	>87
9	>100	>87	>87	>87	>87	>87	>87	>87	>87	>87	>87	>87
10	>100	>87	>87	>87	>87	>87	>87	>87	>87	>87	>87	>87
	RF CAL	0	1	2	3	4	5	6	7	8	9	10

### LO HARMONICS ORDER

Test conditions: RF IN: 1500.1 MHz; -6.00 dBm.  
 LO IN: 1530.01 MHz; +13.00 dBm  
 IF OUT: 29.91 MHz; -13.12 dBm

RF HARMONICS ORDER

	(-dBm)	(-dBc)										
0	-	-	21	23	32	29	39	41	39	54	64	75
1	-	51	+0	43	16	47	29	44	44	45	51	54
2	>100	40	46	45	52	44	67	53	57	68	59	71
3	>100	70	42	69	48	66	47	78	58	58	59	60
4	>100	76	74	62	74	65	72	64	80	68	69	72
5	>100	83	77	82	63	85	64	77	64	87	68	73
6	>100	>97	90	88	89	76	90	75	84	72	>97	78
7	>100	93	93	90	91	94	83	93	84	87	81	91
8	>100	>97	>97	>97	>97	>97	>97	90	>97	92	>97	87
9	>100	>97	>97	>97	>97	>97	>97	>97	>97	>97	95	>97
10	>100	>97	>97	>97	>97	>97	>97	>97	>97	>97	>97	96
	RF CAL	0	1	2	3	4	5	6	7	8	9	10

### LO HARMONICS ORDER

Test conditions: RF IN: 1500.1 MHz; 4.00 dBm.  
 LO IN: 1530.01 MHz; +13.00 dBm  
 IF OUT: 29.91 MHz; -3.19 dBm

- Notes: 1. All Harmonics are in (dBc) relative to IF OUTPUT.  
 2. + entry denotes harmonics are in (dBc) above IF OUTPUT.  
 3. RF Cal represent the Harmonics level of the RF input signal to the mixer.

REV. X2  
 SYM-30DMHW+  
 100818  
 Page 3 of 3



IF/RF MICROWAVE COMPONENTS • ISO 9001 ISO 14001 AS 9100 CERTIFIED • RoHS compliant  
 P.O. Box 350166, Brooklyn, New York 11235-0006 (718) 934-4500 Fax (718) 332-4661



The Design Engineers Search Engine finds the model you need, Instantly • For detailed performance specs & shopping online see



## Outline Dimensions

TTT166  
TTT167

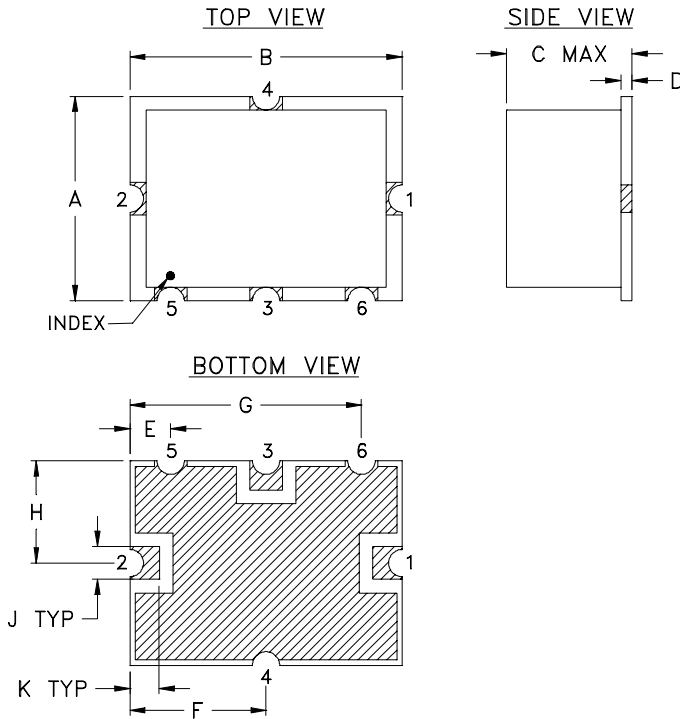

## PCB Land Pattern

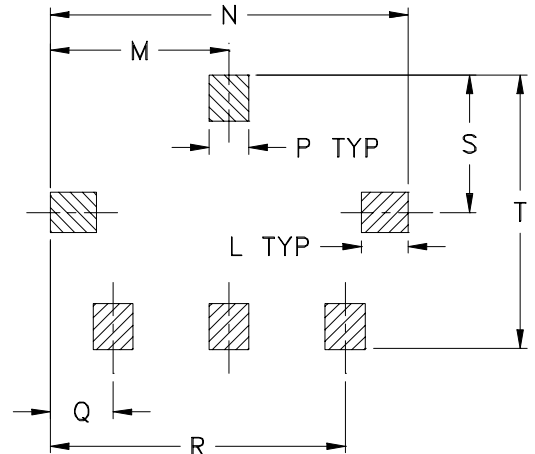

Suggested Layout,  
Tolerance to be within  $\pm .002$

CASE #	A	B	C	D	E	F	G	H	J	K	L	M	N
TTT166	.38 (9.65)	.50 (12.70)	.15 (3.81)	.020 (0.51)	.075 (1.91)	.250 (6.35)	.425 (10.80)	.187 (4.75)	.050 (1.27)	.050 (1.27)	.070 (1.78)	.270 (6.86)	.540 (13.72)
TTT167			.23 (5.84)										

CASE #	P	Q	R	S	T	WT. GRAM
TTT166	.060 (1.52)	.095 (2.41)	.445 (11.30)	.208 (5.28)	.415 (10.54)	.8
TTT167						.8

Dimensions are in inches (mm). Tolerances: 2 Pl.  $\pm .01$ ; 3 Pl.  $\pm .005$

### Note:

- Case material: Plastic.
- Base material: Printed wiring laminate.
- Termination finish:
  - For RoHS Case Styles: 3-5  $\mu$  inch (.08-.13 microns) Gold over 120-240  $\mu$  inch (3.05-6.10 microns) Nickel plate. All models, (+) suffix.
  - For RoHS-5 Case Styles: Tin-Lead plate. All models, no (+) suffix.

# Tape & Reel Packaging TR-F12

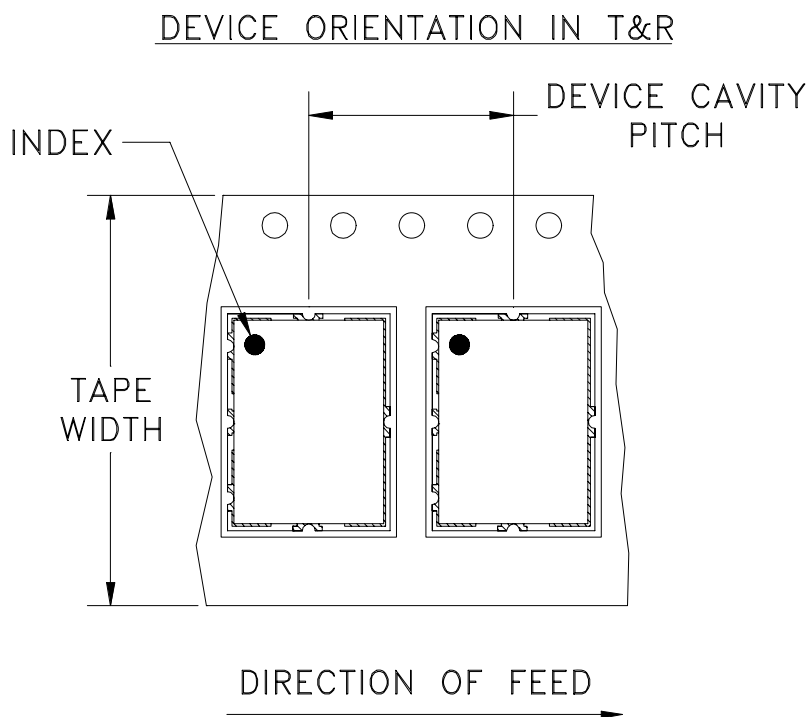

Tape Width, mm	Device Cavity Pitch, mm	Reel Size, inches	Devices per Reel	
24	12	7	Small quantity standards (see note)	10
				20
				50
				100
				200
		13	Standard	500

Note: Please Consult individual model data sheet to determine device per reel availability.

Mini-Circuits carrier tape materials provide protection from ESD (Electro-Static Discharge) during handling and transportation. Tapes are static dissipative and comply with industry standards EIA-481/EIA-541.

Go to: [www.minicircuits.com/pages/pdfs/tape.pdf](http://www.minicircuits.com/pages/pdfs/tape.pdf)

 **Mini-Circuits**<sup>®</sup>

INTERNET <http://www.minicircuits.com>

P.O. Box 350166, Brooklyn, New York 11235-0003 (718) 934-4500 Fax (718) 332-4661

Distribution Centers NORTH AMERICA 800-654-7949 • 417-335-5935 • Fax 417-335-5945 • EUROPE 44-1252-832600 • Fax 44-1252-837010

Mini-Circuits ISO 9001 & ISO 14001 Certified

THIRD ANGLE PROJECTION

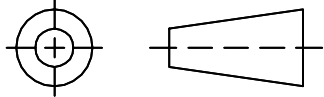

REVISIONS

REV	ECN No.	DESCRIPTION	DATE	DR	AUTH
A	M86762	ADDED CONNECTIONS "lp & lq"	05/23/03	MMG	WL
B	M94598	ADDED CONNECTION "hk"	10/08/04	MMG	HY
C	M102713	UPDATED NOTES & DESCRIPTION	01/14/06	GF	IL
D	M132989	UPDATED NOTE 2	08/24/11	GF	DJ

SUGGESTED MOUNTING CONFIGURATION FOR  
TTT166/167 CASE STYLE, "hk"/"lp"/"lq"  
"x"/"ck"/"ec" PIN CONNECTIONS

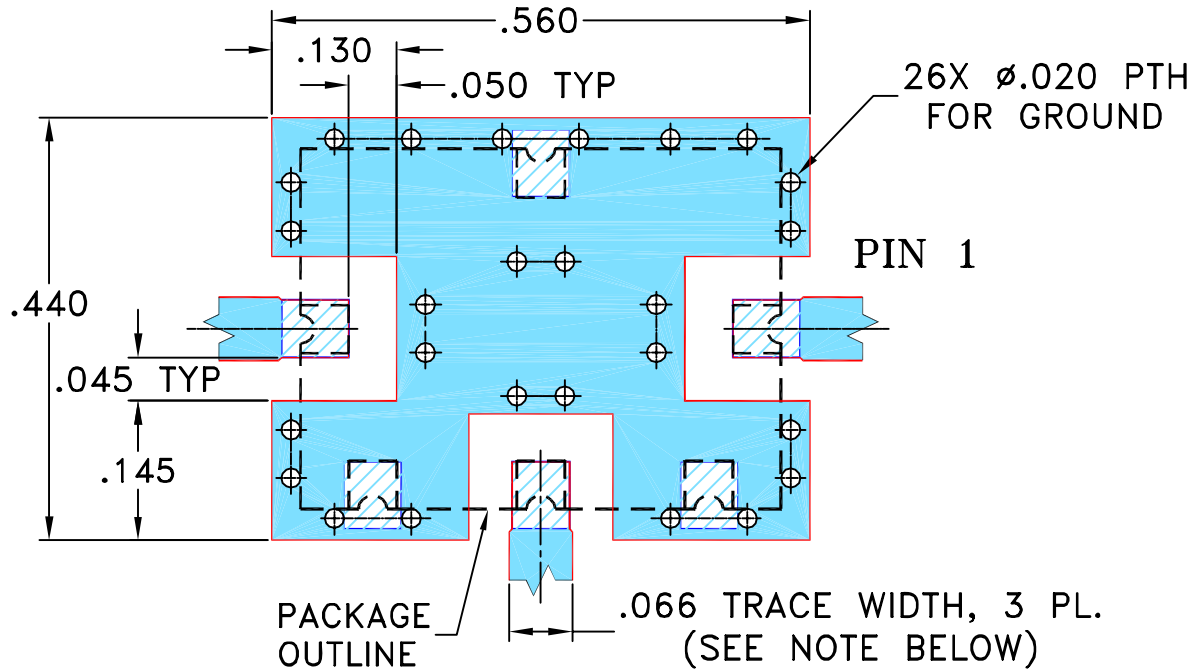

NOTE:

1. TRACE WIDTH IS SHOWN FOR ROGERS R04350B WITH DIELECTRIC THICKNESS .030" ± .002"; COPPER: 1/2 OZ. EACH SIDE. FOR OTHER MATERIALS TRACE WIDTH MAY NEED TO BE MODIFIED.
2. THE USE OF SOLDER MASK OVER THE GROUND AREA UNDER THE UNIT AS SHOWN IS RECOMMENDED TO PREVENT POTENTIAL SHORTING. IF USER CHOOSES TO EXPOSE METAL UNDER THE ENTIRE UNIT GROUND PAD FOR IMPROVED GROUNDING, IT IS RECOMMENDED A SOLDER MASK DAM BE APPLIED AROUND EACH GROUND PAD TO ENSURE FILLET AND CONNECTION AT GROUND PADS.
3. BOTTOM SIDE OF THE PCB IS CONTINUOUS GROUND PLANE.



DENOTES PCB COPPER LAYOUT WITH SMOBC (SOLDER MASK OVER BARE COPPER), SEE NOTE 2.

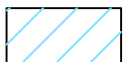

DENOTES COPPER LAND PATTERN FREE OF SOLDER MASK

UNLESS OTHERWISE SPECIFIED

DIMENSIONS ARE IN INCHES  
TOLERANCES ON:  
2 PL DECIMALS ±  
3 PL DECIMALS ± .005  
ANGLES ±  
FRACTIONS ±

	INITIALS	DATE
DRAWN	GF	03/18/03
CHECKED	IL	04/15/03
APPROVED	DJ	04/15/03



Mini-Circuits®

13 Neptune Avenue  
Brooklyn NY 11235

PL, hk/lp/lq/x/ck/ec, TTT166/167,  
SYM/HJK/SYAS/SYPD, TB-12

Mini-Circuits®  
THIS DOCUMENT AND ITS CONTENTS ARE THE PROPERTY OF MINI-CIRCUITS. EXCEPT FOR USE EXPRESSLY GRANTED, IN WRITING, TO ITS VENDORS, VENDEE AND THE UNITED STATES GOVERNMENT, MINI-CIRCUITS RESERVES ALL PROPRIETARY DESIGN, USE, MANUFACTURING AND REPRODUCTION RIGHTS THERETO. THESE CONTENTS SHALL NOT BE USED, DUPLICATED OR DISCLOSED TO ANY OUTSIDE PARTY, IN WHOLE OR IN PART, WITHOUT WRITTEN PERMISSION OF MINI-CIRCUITS.

SIZE	CODE IDENT	DRAWING NO:	REV:
A	15542	98-PL-079	D
FILE:	98PL079	SCALE: 5:1	SHEET: 1 OF 1

# Evaluation Board and Circuit

For Pin Connections Refer to Data Sheet of the DUT

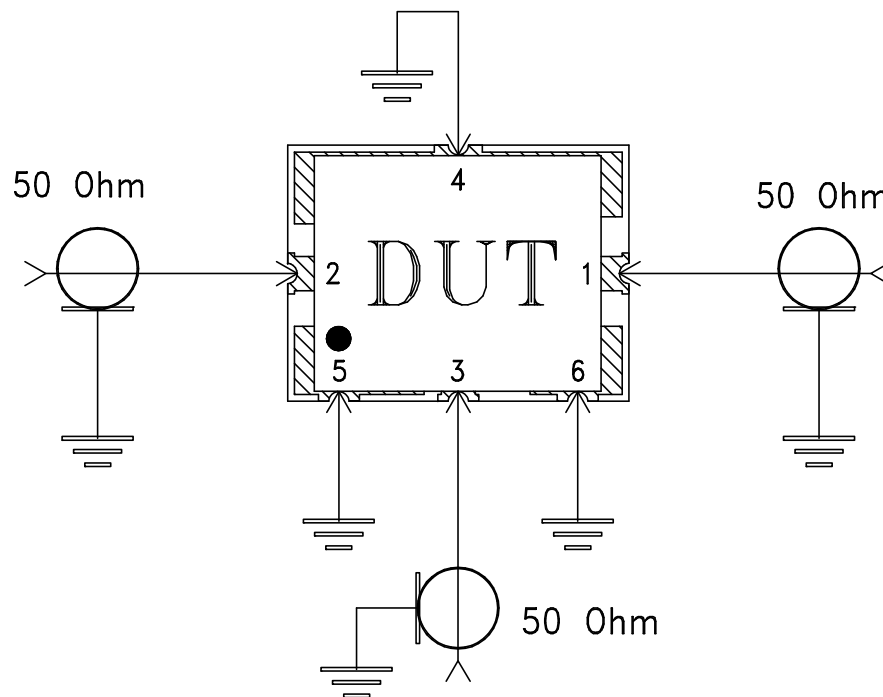
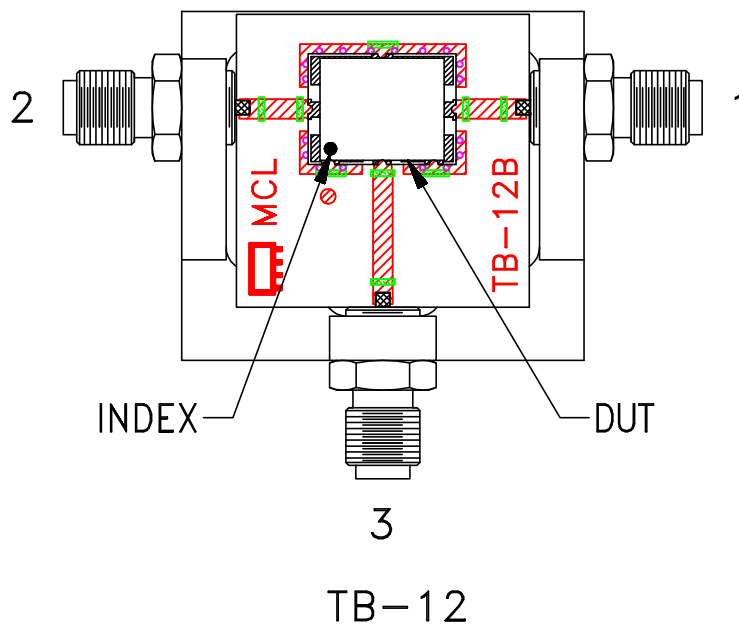

Schematic Diagram

## Notes:

1. SMA Female connectors.
2. PCB Material: Rogers R04350 or equivalent, Dielectric Constant=3.5, Thickness=.030 inch.

 **Mini-Circuits®**



All Mini-Circuits products are manufactured under exacting quality assurance and control standards, and are capable of meeting published specifications after being subjected to any or all of the following physical and environmental test.

Specification	Test/Inspection Condition	Reference/Spec
Operating Temperature	-40° to 85°C Ambient Environment	Individual Model Data Sheet
Storage Temperature	-55° to 100° C Ambient Environment	Individual Model Data Sheet
Humidity	90 to 95% RH, 240 hours, 50°C	MIL-STD-202, Method 103, Condition A, Except 50°C and end-point electrical test done within 12 hours
Thermal Shock	-55° to 100°C, 100 cycles	MIL-STD-202, Method 107, Condition A-3, except +100°C
Solder Reflow Heat	Sn-Pb Eutetic Process: 225°C peak Pb-Free Process 245° - 250°C peak	J-STD-020, Table 4-1, 4-2 and 5-2, Figure 5-1
Solderability	10X Magnification	J-STD-002, 95% Coverage
Vibration (High Frequency)	20g peak, 10-2000 Hz, 12 times in each of three perpendicular directions (total 36)	MIL-STD-202, Method 204, Condition D
Mechanical Shock	50g, 11 ms, 1/2-sine, 18 shocks: 3 each direction, each of 3 axes	MIL-STD-202, Method 213, Condition A
Marking Resistance to Solvents	Isopropyl alcohol + mineral spirits at 25°C; terpene defluxer at 25°C; distilled water + proylene glycol monomethyl ether + monoethanolamine at 63°C to 70°C	MIL-STD-202, Method 215