

## Compact water and dust resistant LiDAR sensor



### Features

- *Application:* A dust and water resistant sensor for distance and height measurement
- *Key features:* Water and dust resistant, small size
- *Measuring range:* 0.2 ... 100 m (LW20/C) or 0.2 ... 50 m (LW20/B)
- *Size:* 30 mm x 20 mm x 43 mm
- *Weight:* 20g
- *Measuring speed:* 48 ... 388 readings per second (configurable)
- *Interfaces:* Serial or I2C and servo driver
- *Integration:* Ardupilot compatible and LightWare Terminal
- *Safety:* Eye safe laser emission Class 1M
- *Environmental:* IP 67 rating



FM 654831

## Table of contents

<b>Overview</b>	<b>3</b>
<b>Specifications</b>	<b>4</b>
<b>Quickstart guide</b>	<b>5</b>
<b>Connection guide</b>	<b>7</b>
Communication with a controller	7
Human Machine Interface (HMI) communication with a USB converter cable	8
Graphical User Interface (GUI) mode	10
Servo	11
Alarms	15
Machine Machine Interface (MMI) communication with a Devantech USB to I2C module	17
<b>Safety instructions</b>	<b>19</b>
Labeling Labelling	19
Laser radiation information	19
<b>Hardware</b>	<b>20</b>
Powering up the LW20	20
Dimension drawings	20
Installation	20
Communication cable	21
<b>Settings</b>	<b>22</b>
HMI main menu	22
HMI servo menu	22
MMI commands set	23
<b>Revision history</b>	<b>27</b>

## Product ordering codes

Model family	Model name	Model description
LW20	LW20/B (50 m)	LiDAR sensor, max 50 m
LW20	LW20/C (100 m)	LiDAR sensor, max 100 m

## Disclaimer

Information found in this document is used entirely at the reader's own risk and whilst every effort has been made to ensure its validity, neither LightWare Optoelectronics (Pty) Ltd nor its representatives make any warranties with respect to the accuracy of the information contained herein.

## 1. Overview

The LW20 is a small form factor, water resistant LiDAR sensor that measures the distance to objects by timing a laser flash. Accuracy is not generally affected by the colour or texture of the target surface, nor the angle of incidence of the laser beam. The LW20 is tolerant to changes in background lighting conditions, wind and noise.

**Please note that the LW20 requires correct grounding to reduce the effects of electromagnetic interference.**

The following capabilities are included in the LW20 as standard:

- Measurement to the nearest detected surface (first return).
- Measurement to the farthest detected surface (last return).
- Selectable filters to adjust the dynamic response to moving targets.
- Adjustable measuring update rate.
- Internal status monitoring.
- Servo driver for scanning applications.

There are two communication interfaces available using a common set of wires:

- A serial port (3.3V logic level) with configurable baud rate to connect to a host controller.
- An I2C serial bus (3.3V logic level and 3.3k pull up resistors) with configurable address as an alternative to the serial port when multiple devices are connected on a common bus.

Application software support is available from the LightWare **API** repository.

**The LW20 LiDAR is rated laser Class 1M eye safe. Do not view the laser with magnifying optics such as microscopes, binoculars or telescopes.**

## 2. Specifications

<b>Performance</b>	
<b>Range</b>	LW20/C: 0.2 ... 100 m ( white wall in daylight conditions) LW20/B: 0.2 ... 50 m ( white wall in daylight conditions)
<b>Resolution</b>	1 cm
<b>Update rate</b>	40 ... 388 readings per second
<b>Accuracy</b>	±10 cm
<b>Connections</b>	
<b>Power supply voltage</b>	4.5 V ... 5.5 V
<b>Power supply current</b>	100 mA
<b>Outputs &amp; interfaces</b>	Serial and I2C (3.3 V)
<b>Mechanical</b>	
<b>Dimensions</b>	30 mm x 20 mm x 43 mm
<b>Weight</b>	20 g (excluding cables)
<b>Optical</b>	
<b>Laser safety</b>	Class 1M (Refer to <a href="http://www.lightware.co.za/safety">www.lightware.co.za/safety</a> for full details)
<b>Optical aperture</b>	28 mm x 15 mm
<b>Beam divergence</b>	<0.5°
<b>Environmental</b>	
<b>Operating temperature</b>	-10 ... +50°C
<b>Approvals</b>	FDA: 1710193-000 (2020/09)
<b>Enclosure rating</b>	IP67
<b>Accessories</b>	
<b>Main cable</b>	Main cable - 5 way with shield, 32 AWG
<b>Default settings</b>	
<b>Serial port settings</b>	115200 baud, 8 data bits, 1 stop bit, no parity, no handshaking
<b>I2C address</b>	0x66 (Hex), 102 (Dec)
<b>Update rate</b>	48 readings per second
<b>Main cable connections</b>	
<b>Black</b>	GND - power supply negative
<b>Red</b>	+5V - power supply positive (4.5V to 5.5V at 100mA)
<b>Yellow</b>	TXD/SDA - serial data transmitted or data for I2C
<b>White</b>	RXD/SCL - serial data received or clock for I2C
<b>Blue</b>	Servo control line
<b>Shield</b>	Earth point to reduce EMI

### 3. Quickstart guide

#### Caution

**The LW20 contains a laser and should never be aimed at a person or an animal. Do not look at the beam directly with optical instruments.**

- Download the **LightWare Terminal** application to your PC or laptop.
- Install and start the application by following the prompts.
- Connect the LW 20 to the PC using a serial (3.3V UART) to USB adaptor.
- The LW 20 will automatically be detected by the application.
- Press the <↑> keyboard key to engage serial communication mode (if you are using an alternative Terminal emulation program, send the character string <UU>. The LW 20 will reply with a product code, firmware revision and hardware revision number.

```
p:SF20,1.7.0,12
```

- Press the <ESC> keyboard key and the LW20 will display a live data stream - first distance signal, last distance signal, alarm A status and alarm B status - in the LightWare Terminal application window.

```
...
2.68 2.68 1 1
2.68 2.68 1 1
2.68 2.68 1 1
...
```

- Press the <SPACE> key to display the main menu. This menu includes a list of all the settings that can be changed in the unit:

```
*** LW20 V16 Firmware: V1.7.0 ***
Serial: S20-*****
```

1: Measurement update rate	55 per sec
2: Serial port baud rate	115200
3: I2C address	0x66
4: Zero distance offset trim	0.00 m
5: Number of lost results before out of range	25
6: Alarm A distance	10.00 m
7: Alarm B distance	5.00 m
8: Alarm hysteresis	0.10 m

<- Use arrow keys to navigate ->

- Change the settings to suit your application.
- Unplug the USB adaptor when finished.

Once the settings have been entered, your host controller can communicate with the LW20 through the serial or I2C ports. API support is available from the LightWare **API** repository.

Sensors have a resolution of 1 centimeter and the accuracy of each measurement is  $\pm 10$  centimeter. Laser precise distance measurements provide the exact height above ground level for multi-copter drones to set off alarms when the ground gets too close. The LW20 is able to measure the first and last return signals when there is more than one object in the laser beam - objects must be separated by approximately 5 meters before they are seen as separate return signals. For terrain following applications, this enables a drone to track the closest tops of trees, and measure the height above ground simultaneously, to get information about potential collisions.

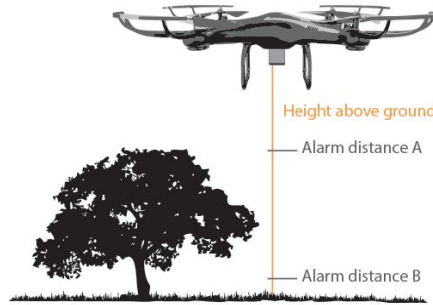

Measuring exact height above ground

The LW20 outputs measurements from 48 readings per second, to a maximum of 388 readings per second. The slower reading rate gives better measuring range for forwards-facing obstacle detection. The faster reading rate is better for scanning applications. By adding a small digital servo, the LW 20 has built-in drivers to allow the unit to scan the area ahead of autonomous vehicles. Ideal for sense-and-avoid navigation, the LW20 can either stream the measured data to the communication ports for “SLAM(Stop Look Assess and Manage)” mapping, or analysed internally to look for potentially hazardous alarm conditions.

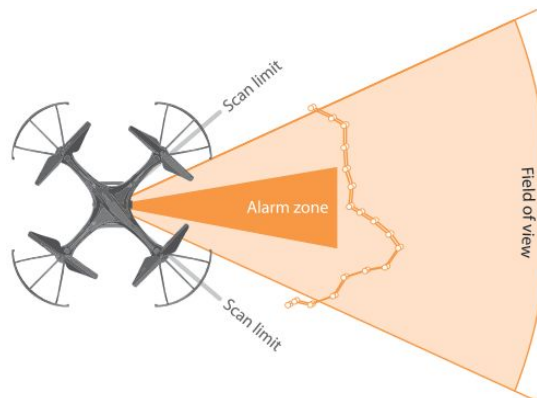

Collision avoidance zones

There are two enclosure options available, the LW20 and the SF20. The LW20 is a sealed waterproof IP67 unit suitable for outdoor applications. Weighing less than 20 grams (excluding cables), it is ideal for applications where the weight and size are important. The SF20 is an open frame, 10 gram unit, suitable for OEM applications when low mass is the defining specification. The SF20 is not waterproof.

The SF20 / LW20 includes serial, I2C and alarm outputs that can be easily connected to a flight controller or a standard processing platform. Each interface on the SF20 / LW20 can be configured using a simple software menu.

The SF20 / LW20 LiDAR is rated laser Class 1M eye safe. Do not view the laser with magnifying optics such as microscopes and telescopes.



## 4. Connection guide

### Caution

**The LW20 laser rangefinder contains a laser and should never be aimed at a person or an animal. Do not look at the beam directly with optical instruments.**

You can communicate with the LW20 unit in a number of ways:

#### 4.1. Communication with a controller

The LW20 is designed to communicate with a host controller. This controller can be a single board computer, flight controller, PC or laptop.

There are two communications interfaces available, serial and I2C. The LW20 will wait for the first command to confirm which communication mode to select (serial or I2C). The first command will not get a response.

The serial port is a one-to-one protocol that lets a single LW20 talk to a single host controller. The serial interface uses 3.3 V logic to transmit results and receive commands.

Multiple LW20's with an I2C port can be connected onto an I2C bus. The I2C interface uses 3.3 V logic to receive commands from a master device.

The communication language for both the serial and I2C ports is based on ASCII commands and messages. Command strings take the form of simple mnemonics and results are provided as text strings.

A command string is made up of:

- A directive that indicates what action to take
- A channel that represents a functional block containing related information
- An index that determines which value is being acted on
- A numeric value if needed
- **<CR><LF>** indicates the end of the command

There are four different directives, each using a single ASCII character:

? Fetch a value  
 # Write a value  
 \$ Stream live results  
 % Save changes

There are six channels available inside the LW20:

P The Product channel contains product related information  
 L The Laser channel contains all laser related information  
 S The Servo channel contains all servo related information  
 C The Communication channel handles serial and I2C data  
 A The Alarm channel provides alarm status information

A typical command sent by the host controller would be:

```
?PN<CR><LF>
```

Which means: What is your Product Name?

The SF20 / LW20 would reply with:

```
PN:LW20 <CR><LF>
```

Which means: Product Name : LW20

Full details of the communication language are given in Section 7.3.

#### 4.2. Human Machine Interface (HMI) communication with a USB converter cable

- Download the LightWare Terminal application from [www.lightware.co.za](http://www.lightware.co.za) onto your PC or laptop. Open the installer package and follow the installation instructions. Everything needed for communicating with the unit will automatically be installed.
- Connect the serial port of the LW20 to the USB port on a PC or laptop using a serial UART TTL (3.3 V logic, 5 V power) to USB adapter such as the TTL-232R-3V3-WE converter cable from FTDI. This will allow for communication and power supply to the LW20. A red indicator light will show that the unit is powered up.



- Start the LightWare Terminal application and click on the “Settings” icon and set the baud rate to “115200”. Select the correct “Protocol” for your communication type and the correct USB port. You can tick the “Remember settings” box if you intend to use this configuration again. Click “Apply” the change to close the dialog window.

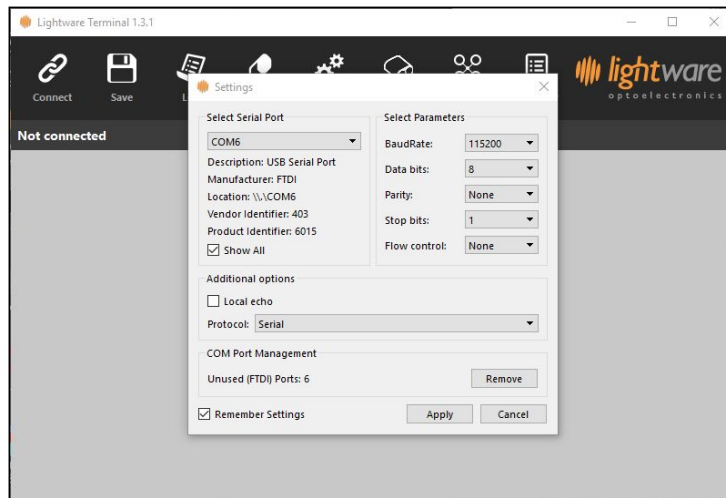

- Click the “Connect” icon to open a communication port.

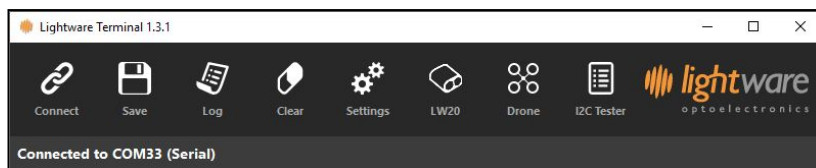

- Press the <↑> keyboard key to engage serial communication mode (if you are using an alternative Terminal emulation program, send the character string <UU>). The LW20 will reply with a product code, firmware revision and hardware revision number.

```
p:SF20,1.7.0,12
```

- Press the <ESC> keyboard key and the LW20 will display a live data stream - first distance signal, last distance signal, alarm A status and alarm B status - in the LightWare Terminal application window.

```
...
2.68 2.68 1 1
2.68 2.68 1 1
2.68 2.68 1 1
...
```

- The live data stream displays the first distance signal, last distance signal, alarm A status and alarm B status. The servo live data stream (if it is attached) displays the aiming angle, first distance signal, last distance signal, alarm A status and alarm B status.
- Press the <SPACE> key to display the main menu. This menu includes a list of all the settings that can be changed in the unit:



\*\*\* SF20 V11 Firmware: V1.7.0 \*\*\*  
Serial: S20-\*\*\*\*\*

1: Measurement update rate	55 per sec
2: Serial port baud rate	115200
3: I2C address	0x66
4: Zero distance offset trim	0.00 m
5: Number of lost results before out of range	25
6: Alarm A distance	10.00 m
7: Alarm B distance	5.00 m
8: Alarm hysteresis	0.10 m

<- Use arrow keys to navigate ->

- To activate a menu item, press the keyboard key relating to that menu. Some of the menu values are numeric, and others will toggle between the available options. For example, to access the menu item “**1: Measurement update rate**” - which toggles through “**48 per sec**”, “**55 per sec**”, “**64 per sec**”, “**77 per sec**”, “**97 per sec**”, “**129 per sec**” and “**388 per sec**” as the preferred rate at which distances are measured - press the <1> key. Note that any changes made are stored immediately in permanent memory, and will remain valid after the power is removed. Information regarding the other menu items, and how to use them for your application, is contained in the body of this document.
- You can navigate between the main menu and the servo menu (if attached), and between the live data stream, and the servo live data stream (if attached) using the <=>,<←>,<↓> and <↑> keyboard keys.

\*\*\* Servo settings \*\*\*

C: Servo connected	no
S: Servo scanning	no
P: Go to position	0.0 degrees
M: Go to midpoint	
1: Minimum allowed pulse width	1000.0 us
2: Maximum allowed pulse width	2000.0 us
3: Angular scale	10us per degree
T: Scan type	bi-directional
R: Steps per reading	4 = 0.27 degrees per reading
L: Servo Lag	0.00 degrees
4: Field of view - lowest angle	-180.0 degrees
5: Field of view - highest angle	180.0 degrees
6: Alarm A - low angle	- 90.0 degrees
7: Alarm A - high angle	0.0 degrees
8: Alarm B - low angle	0.0 degrees
9: Alarm B - high angle	90.0 degrees

<- Use arrow keys to navigate ->

- Information regarding the other menu items, and how to use them for your application, is contained in the body of this document.
- To exit the menu, press the <SPACE> key and the unit will resume taking distance measurements.
- Pressing the “**Save**” icon to save the information currently displayed on the Terminal, the information is saved as a **txt** file.
- Pressing the “**Log**” icon allows the user to log the live streamed data either as a **txt** file or as a **csv** file.
- Pressing the “**Clear**” icon clears the workspace in Terminal.
- Under the “**Settings**” icon, the Serial Port, Baud Rate and Communication protocol can be selected.
- The “**LW20**” icon is explained in the next section (4.2).
- The “**Drone**” icon is still an experimental feature that allows one to upload pixhawk settings directly to Pixhawk.
- The “**I2C Tester**” icon will be explained in section (4.5).
- Press the “**Disconnect**” icon before unplugging the USB cable.

### 4.3. Graphical User Interface (GUI) mode

- Connect your LW20 to a PC or laptop as detailed in section “4.2 Human Machine Interface (HMI) communication with a USB converter cable”
- Start the LightWare Terminal application and click the “**Connect**” icon to open a communication port.
- Click the “**LW20**” icon to open the GUI home screen. There are four tabs at the top of the home screen. Each one provides a visualization of the settings inside the LW20 and guides you through the setup process as follows:
- The “**Home**” tab shows the welcome screen with shortcuts to other screens.

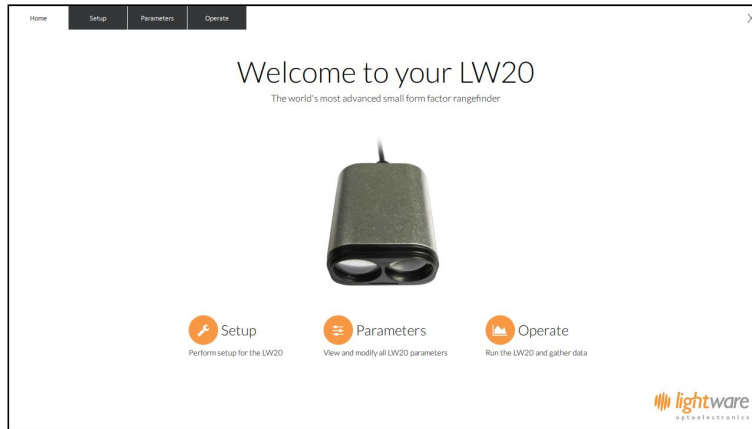

- The “**Setup**” tab is for checking or entering settings with graphical indicators showing the effect of any changes. The “**Setup**” tab is divided into three functional areas. On the left there are four buttons that group related settings together. In the middle column the names and values of each setting are shown in editable boxes. On the right of the screen there is a graphic visualizing the group of settings.
- The four Setup buttons have the following features:
  - The “**Laser**” button is for settings that relate to distance measurement, communication and encoding
  - The “**Servo**” button is to configure the physical parameters of servo chosen for scanning
  - The “**Sweep**” button defines the software limits of the scan
  - The “**Alarm**” button is used to create software controlled, two dimensional alarms

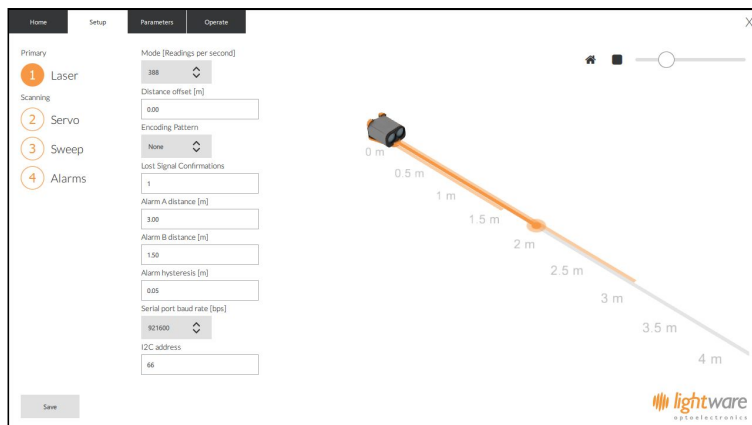

- The “**Parameters**” tab gives a tabulated summary of all the settings. The “**Parameters**” tab gives a summary of all the available settings, grouped into columns to match the buttons on the “**Setup**” tab. This tab is useful to users who are familiar with the effects of each setting and know what values to enter for their application.

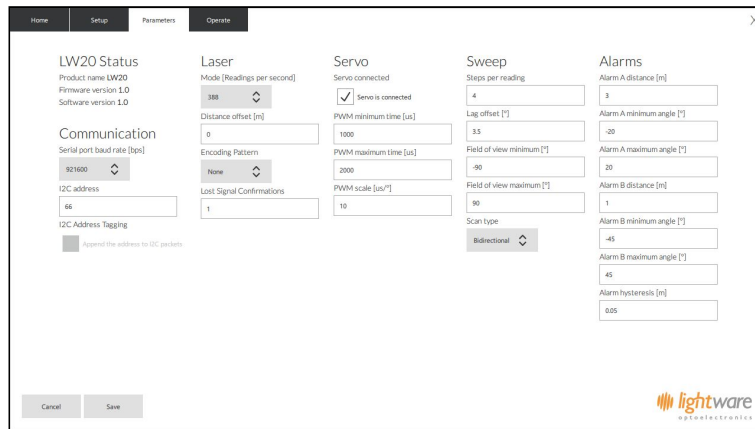

- The **“Operate”** tab is a graphical display that shows the LW20 working with the settings that you have entered, it shows a graphic that can be used for display purposes. Different elements can be added or removed from the image using the tick boxes and the view can be changed to represent either single point distance measurement or two dimensional LiDAR scanning.

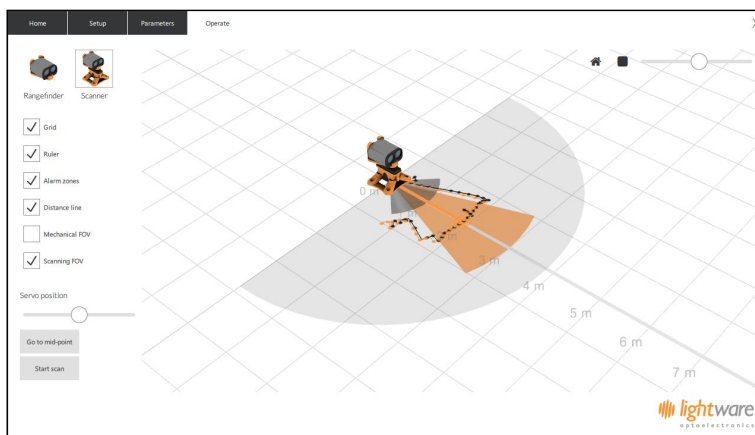

- Note that any settings changes are not automatically saved. The **“Save”** button must be pressed if you want to keep the changes. The graphics can be manipulated to alter their position and angle of view using the left and right mouse keys. There is a scale slider in the top right hand corner along with icons to return to the default isometric view or change to a view from above.

#### 4.4. Servo

The LW20 can be converted into a scanning LiDAR by attaching it to a digital servo and using the built-in servo driver hardware and software. The LiDAR data can be streamed live or used to activate two internal alarms. This makes a useful SLAM mapping device or a collision sensor.

The servo driver works with most standard digital servos. Note that analog servos are not compatible as they respond too slowly to the control signals produced by the LW20. The LW20 is connected to the servo as shown in the diagram below:

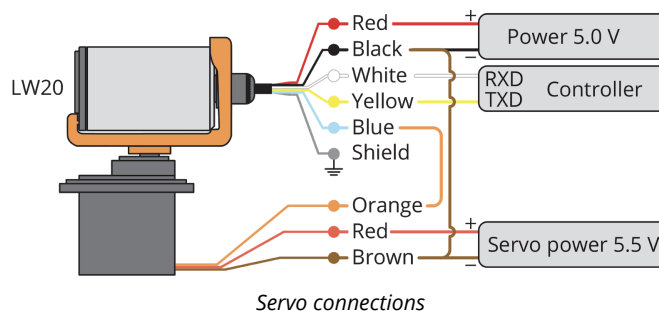

Servo connections

To reduce the chances of power supply spikes affecting the performance of the LW20, it is important to run the servo from a separate power supply. Check the servo specifications for the correct voltage and current ratings and make sure that there is a common connection to the negative rails of the LW20 and servo power supplies.

Communications to the LW20 and the servo can be made through either the serial port or via an I2C bus. In this guide we will use the serial port and the GUI interface to set up the servo parameters and configure automatic scanning.

Start the LightWare Terminal application and click the **"Connect"** icon to open a communications port. Click the **"LW20"** icon to open the GUI home screen. Select the **"Servo"** button under the **"Setup"** tab to access the initial servo configuration graphic.

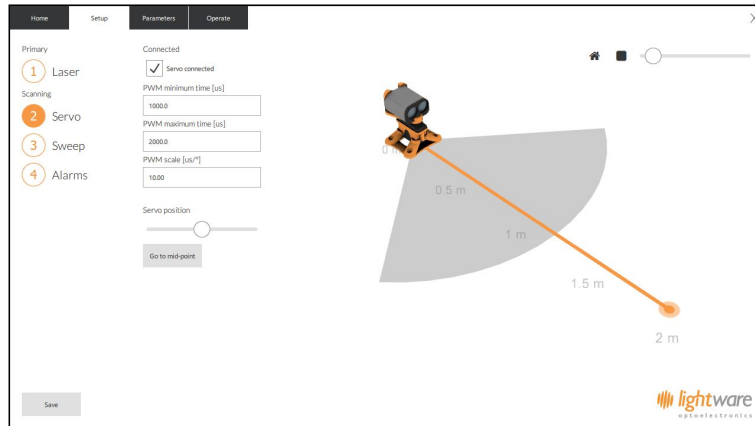

*Setting up the electrical and mechanical characteristics of the servo*

With the LW20 connected to the GUI, settings can be entered and saved even without the servo attached. This is useful if you already know what values to enter for your chosen servo. If the servo is connected, then ticking the **"Connected"** box and entering settings through the GUI will result in live movements of the servo, allowing you to see the effect of the new values.

The servo position is controlled by a pulse-width modulated (PWM) signal coming from the blue control line of the LW20. This signal can change in width from 0 us to 3000 us in steps of 0.7 us and updates 333 times per second. A given servo will be limited to a specific range of PWM widths, corresponding to the physical limits of rotary motion. By default the minimum PWM width is set to 1000 us and the maximum PWM width to 2000 us. This is suitable for most servos but new values can be entered if needed. If a new value beyond the capabilities of the servo is entered, the servo may draw too much power, get hot or buzz.

## Caution

**Setting PWM values outside the specified range of the servo may cause damage to the servo.**

When viewed from above, the lower PWM setting turns the servo shaft to the extreme left position and the higher PWM setting turns it to the extreme right. The midpoint position corresponds to the PWM value that is halfway between the two end settings.

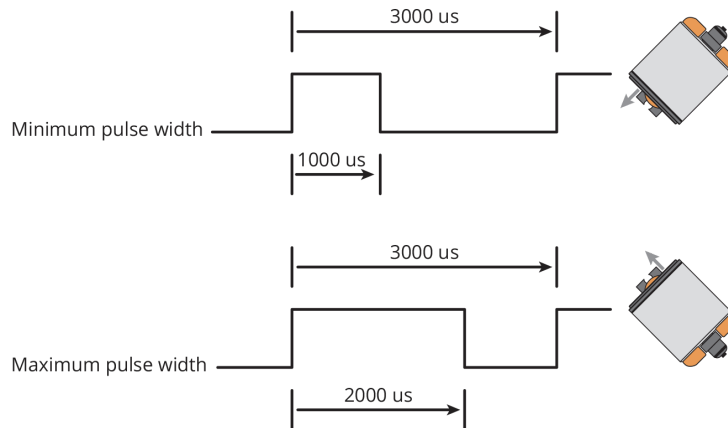

*Setting the servo's limits of motion using the PWM values*

For each degree of motion by the servo, the PWM pulse width needs to change by a specific number of us. This "PWM scale" can usually be found on the data sheet of the servo. Alternatively, you can measure how many degrees the servo moves for a 1000 us change in PWM pulse width and calculate the PWM scale from this result. The default scale value is 10.00 us per degree as shown in the picture below:

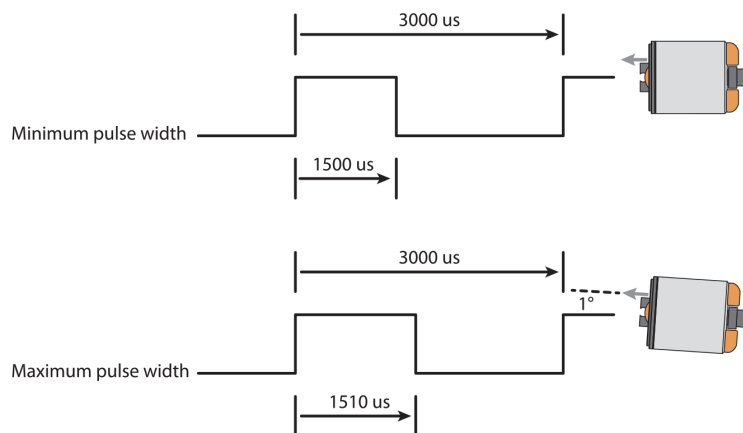

*Setting the servo's PWM scale*

Once the settings have been entered, the servo can be manually positioned using the slider near the bottom of the graphic page. This slider works in 5 degree increments. The central or middle position can be checked by pressing the "Go to midpoint" button. The midpoint should be lined up with the forward direction of whatever the servo is mounted on. In the graphic, the physical range of angular motion of the servo is shown as a grey segment.

Note that settings will only be saved to the LW20 once the "Save" button in the bottom left corner of the screen has been pushed.

Once the electrical characteristics of the servo have been entered using the method above, the servo can be used to aim the LW20 in a specific direction or autonomously scan the LW20 to produce LiDAR maps and provide collision warning alarms.

Configuring the scanning motion is done by selecting the "Sweep" button under the "Setup" tab. Note that the settings entered here are limited by the physical and electrical characteristics of the servo. Only the first return signal is shown on the graphic.

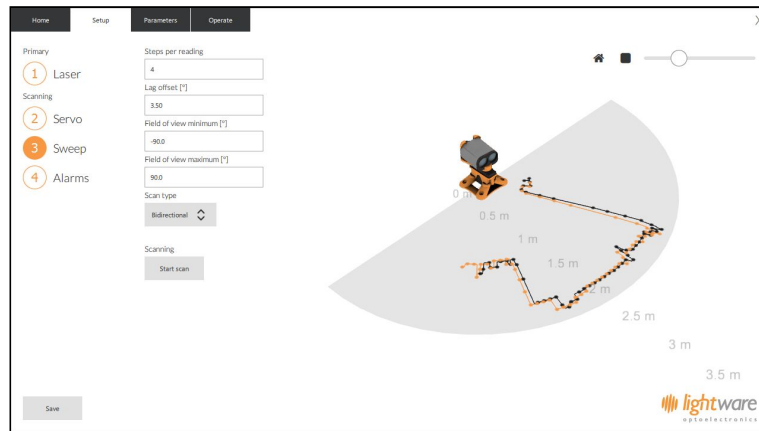

### Setting up the servo's scanning characteristics

The speed of the scan is determined by how fast the LW20 updates and the number of steps that the servo moves with each reading. The **"Steps per reading"** box increases or decreases this speed as does the update rate setting in the **"Laser"** section. Running the servo faster increases its power consumption but provides a faster response to changes in measurements. If the servo moves too fast its range of motion may be decreased.

Each direction of the scan is indicated in a different color on the graphic. This is to emphasize the effect of "servo lag" that most servos exhibit when moving at a constant speed. Servo lag comes about because servos are designed to aim in a fixed direction and their control systems are optimized for this type of action. When the servo moves continuously, the control loop isn't able to catch up with the aiming direction and always lags behind.

The number of degrees of lag is different for different servos, at different speeds and at different power supply voltages. To correct for this lag enter a value in the "Lag offset" box. This is typically between 0.5 degrees and 10 degrees depending upon the torque, speed and quality of the servo. By making small adjustments to the lag offset the images from each direction of scan can be made to coincide, as seen in the picture below.

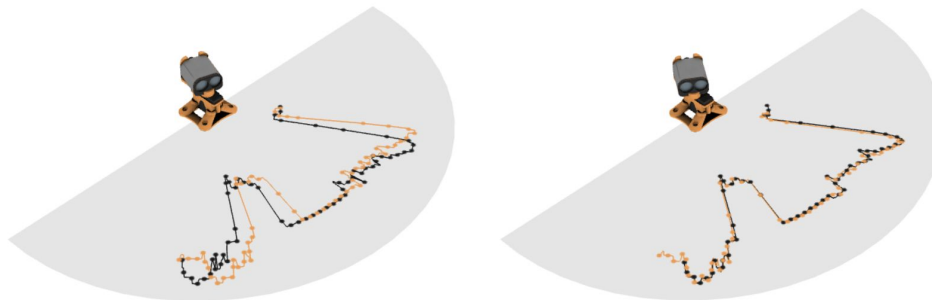

*The effect of servo lag with no correction and after applying a 2.5 degree correction*

Once the servo lag has been corrected, the mechanical motion of the servo will remain consistent. From time to time the settings should be checked in case wear on the gears or changes to the power supply have affected the servo.

In most applications, the field of view of the scanning pattern will need to be reduced. This could be because of fixed objects inside the scanning area or to remove errors at the edges of the scan caused by the servo changing direction.

Changing the field of view does not affect the physical motion of the servo as this would upset the PWM and servo lag settings. Instead, the field of view cuts out unwanted data from the edges of the scanned image. The left and right edge settings of the field of view can be changed independently.

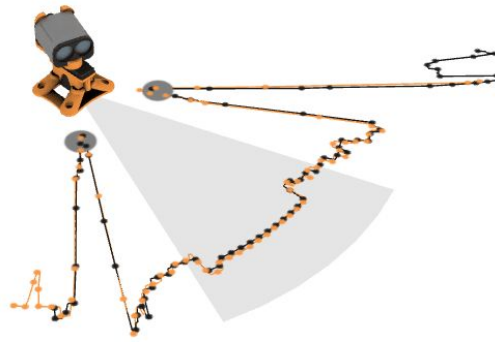

*Reducing the field of view to avoid detecting the landing legs on a drone*

For high precision scanning, the servo can be made to scan in one direction only. The resulting image has higher angular repeatability at the expense of increased power consumption by the servo when returning to the start of the scan. Switching from bi-directional to uni-directional scans is done using the “**Scan type**” selection box.

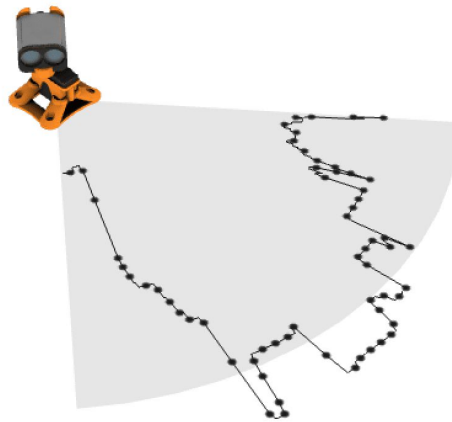

*Uni-directional scanning for higher precision*

#### 4.5. Alarms

The LW20 has two alarms, A and B, that can be used to warn when objects get too close. The alarm changes from a 0 state to a 1 state when an object is detected closer than the set distance. The alarms are updated every time a new distance measurement is taken.

Communications to the LW20 can be made through either the serial port or via an I2C bus. In this guide we will use the serial port and the GUI interface to set up the servo parameters and configure automatic scanning.

Start the LightWare Terminal application and click the “**Connect**” icon to open a communications port. Click the “**LW20**” icon to open the GUI home screen. Select the “**Laser**” button under the “**Setup**” tab to access the configuration graphic.

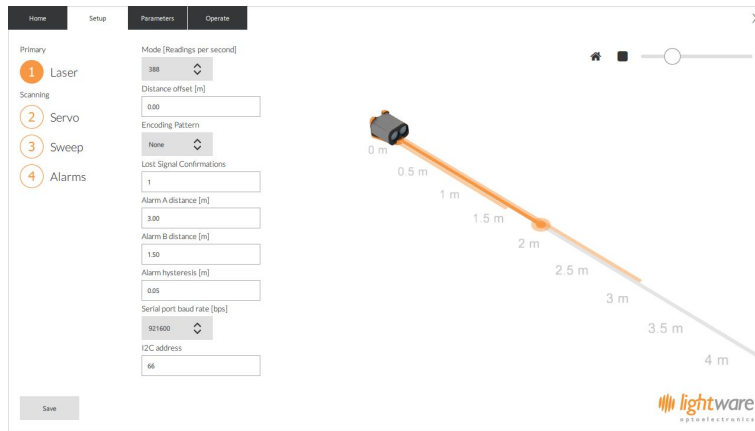

*Setting the alarms to warn of nearby objects*

The alarms can also be used in scanning mode when the LW20 is attached to a servo. In this case, the alarms become two dimensional with distance and angle settings. Two dimensional alarms update at the ends of each sweep and remain in a fixed state for the duration of the sweep, giving the host controller time to check the alarm status.

The two dimensional alarm settings can be found using the **“Alarms”** button under the **“Setup”** tab. The segment representing alarm A is indicated in orange and alarm B is indicated in grey. The colored areas flash when an object is detected inside the alarm zone.

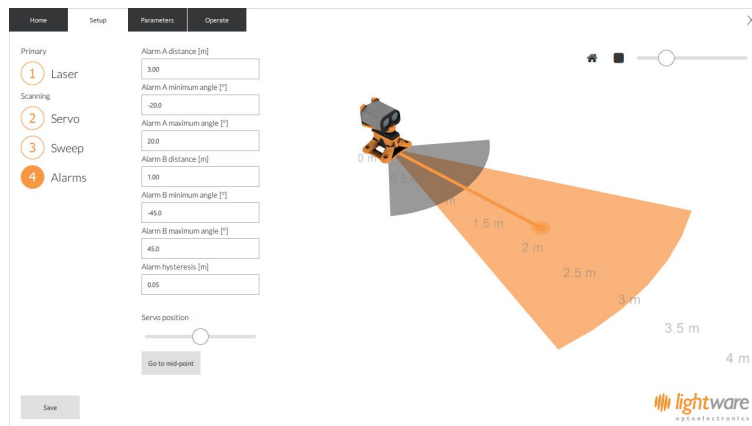

*Setting two dimensional alarms*

You can use the position slider to check the activation of alarms at different scanning angles.



#### 4.6. Machine Machine Interface (MMI) communication with a Devantech USB to I2C module

The I2C interface is designed for machine-to-machine communications with multiple devices over a small network. In order to test the I2C interface on the LW20, an I2C to USB converter can be connected and a limited number of commands can be sent to the LW20 using the LightWare Terminal application.

- Connect the serial port of the LW20 to the USB port on a PC or laptop using a Devantech USB to I2C, SPI, Serial Adaptor module (USB-ISS). This will allow for communication and power supply to the LW20. A red indicator light will show that the unit is powered up.

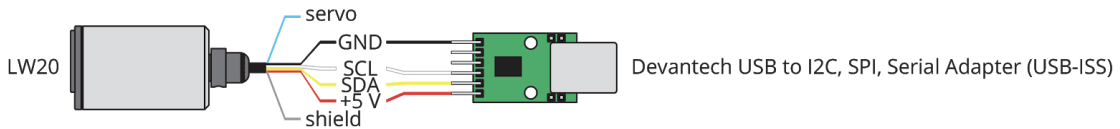

- Start the LightWare Terminal application and click on the “Settings” icon and set the baud rate to “115200”. Select the correct “Protocol” for your communication type. This should match the I2C converter being used and in this example the Devantech USB-ISS adaptor is shown.
- You can tick the “Remember settings” box if you intend to use this configuration again. Click “Apply” the change to close the dialog window.

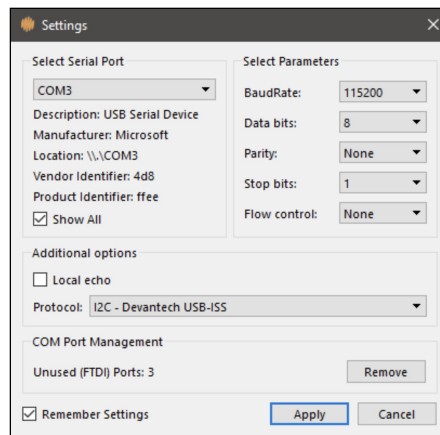

- Click the “Connect” icon to open a communication port.

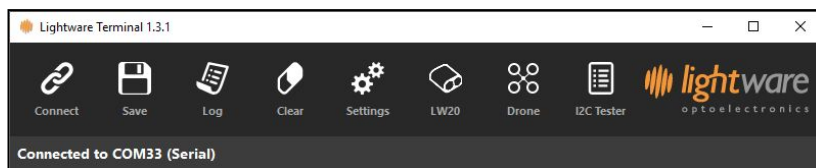

- Once connected, open the I2C tester by clicking on the “I2C Tester Icon”. Located inside the I2C tester page, there are three buttons. these three buttons have been programmed as follows:
  - **Get Product** - this sends the command <?>
    - p:SF20,1.7.0,12 (The LW20 will reply with a product code, firmware revision and hardware revision number.)
  - **Distance (First Pulse Median)** - this sends the command <?LDF,0>
    - ldf,0:5.82
  - **Distance (First Pulse Raw)** - this sends the command <?LDF,1>
    - ldf,1:5:83
- A full list of I2C commands can be viewed under the command list provided later in this document.
- The factory default I2C bus address is **0x66**.

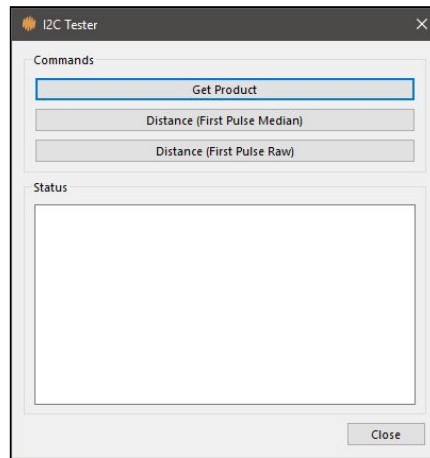

- Using an alternative emulation program, send the character string <UU>. The LW20 will reply with a product code, firmware revision and hardware revision number.
- In this mode, the LW20 will respond to the command set normally used by a controller to communicate using either the serial or I2C ports (please refer to section 7.3 for a comprehensive list of commands and how to communicate with the unit via I2C).
- Press the “**Disconnect**” icon before unplugging the USB cable.

## 5. Safety instructions

The LW20 is a laser based altimeter that emits ionizing laser radiation. The level of the laser emission is Class 1M which indicates that the laser beam is safe to look at with the unaided eye but must not be viewed using binoculars or other optical devices at a distance of less than 0.5 meters. Notwithstanding the safety rating, avoid looking into the beam and switch the unit off when working in the area.

### Caution

**The use of optical instruments with this product will increase eye hazard.**

The LW20 should not be disassembled or modified in any way. The laser eye safety rating depends on the mechanical integrity of the optics and electronics so if these are damaged do not continue using the LW20. There are no user serviceable parts and maintenance. Repairs must only be carried out by the manufacturer or a qualified service agent.

No regular maintenance is required for the LW20 but if the lenses start to collect dust then they may be wiped with suitable lens cleaning materials. Make sure that the LW20 is switched OFF before looking into the lenses.

### 5.1. Labeling

#### Labelling

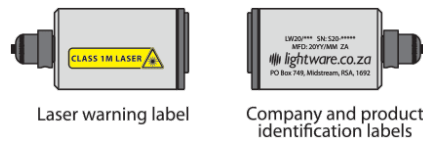

*Laser radiation information and labels*

### 5.2. Laser radiation information

Specification	Value / AEL	Notes
Eye safety classification	Class 1M	
Laser wavelength	905 nm	
Pulse width	16 ns	
Pulse frequency	20 kHz	
Average power	< 2.5 mW	7 millimeter aperture

## 6. Hardware

6.1. Powering up the LW20

The power supply, communications and servo driver signals are connected to the LW20 using a built-in cable. The cable has a shield that should be earthed to reduce electrical interference. The power supply voltage must be between 4.5 V and 5.5 V and the LW20 draws about 100 mA while measuring. It is good practice to make sure that the power supply is able to deliver more current than needed and to make sure that the voltage is stable and clean from spikes.

6.2. Dimension drawings

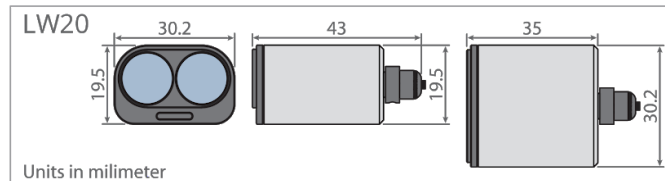

6.3. Installation

LW20 Rangefinders require a clear line-of-sight to measure distance to a target surface. They can be mounted with a vertical or horizontal lens orientation.



They can be mounted in a downward facing orientation for altimetry, terrain following or precision landing applications. For terrain following, install the rangefinder at an angle to reduce lag time in reaction. The angle depends on the speed traveled, and the overall system lag, but should be between 20 and 45 degrees. They can be mounted forward facing orientation for sense-and-avoid or position-hold applications.

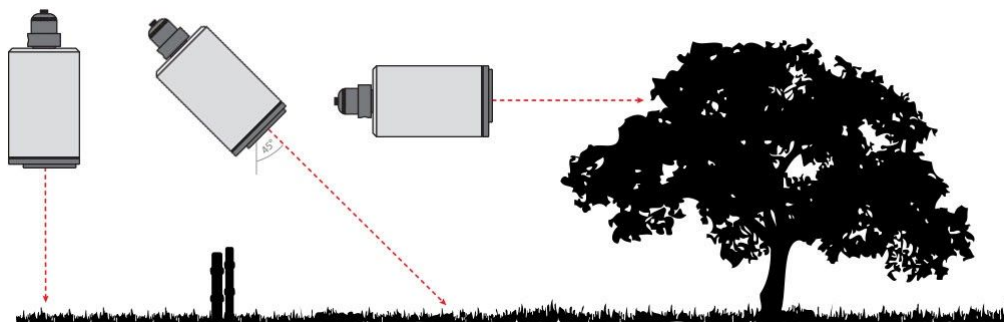

Several mounting accessories can be purchased, or downloaded from the [LightWare website](http://www.lightware.co.za).

Do not mount the rangefinder within the cavity of an airframe, rather mount it directly at the surface boundary. This can prevent beam divergence from causing false readings in short range distances, or out of range conditions.



## Precautions

Ensure that nothing is in the path of the laser beam.

Ensure that no shiny or highly reflective surfaces are near the path of the beam.

Secure the cable with zip ties to protect it from pulling on the connectors.

### 6.4. Communication cable

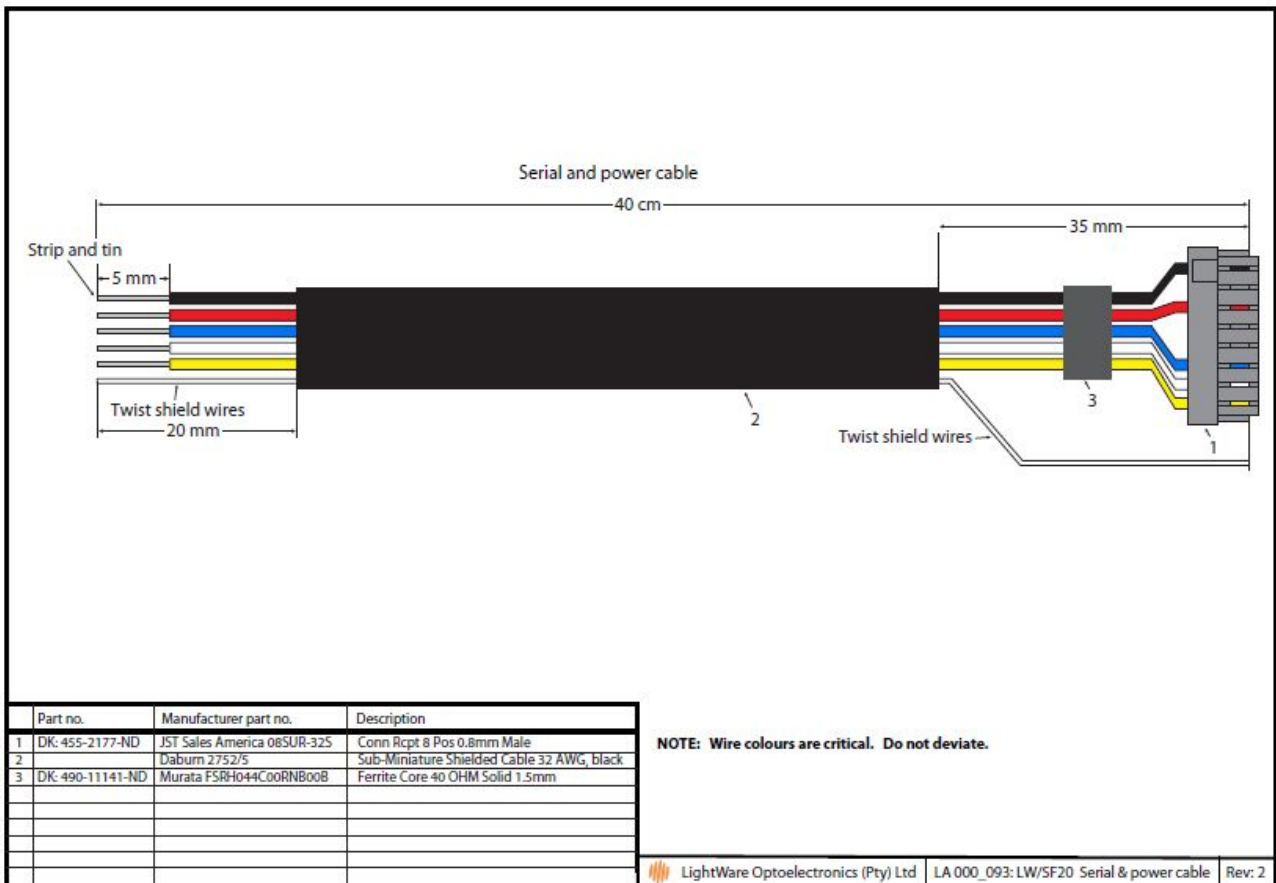

### 6.5. Pinout diagram for LW20

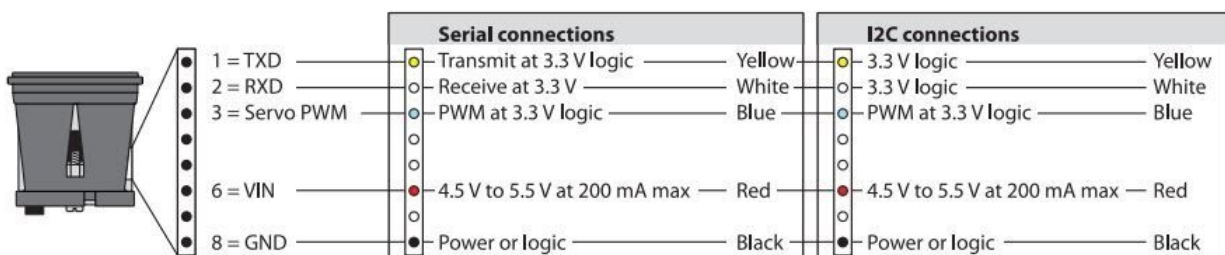

## 7. Settings

**7.1. HMI main menu**

Setting	Values	Description
1: Measurement update rate	48 ... 388 readings per second	Sets the rate at which distances are measured.
2: Serial port baud rate	9600 ... 921600	Select the baud rate for the serial communication port. Note that new values take effect after they are saved and power is cycled, the factory default is 115200.
3: I2C address	0x00 ... 0x7F	The address of the LW20 on the I2C bus, the factory default is 0x66.
4: Zero distance offset trim	-10.00 ... 10.00 meters	Moves the point at which the measured distance reads zero. This is to correct for errors introduced by the mounting position.
5: Number of lost results before out of range	1 ... 250	Sets the number of readings that must be taken before a lost signal or out-of-range condition is reported. This value prevents brief losses of signal from affecting the distance results.
6: Alarm A distance	0 ... 100 meters	Sets the activation distance of alarm A. This is the distance below which the alarm changes state from '0' to '1'.
7: Alarm B distance	0 ... 100 meters	Sets the activation distance of alarm B. This is the distance below which the alarm changes state from '0' to '1'.
8: Alarm hysteresis	0 ... 10 meters	The alarm hysteresis prevents the alarms from switching rapidly between states when the target surface is at the activation distance. Activation occurs at the set distance minus the hysteresis distance and deactivation occurs at the set distance plus the hysteresis distance.

**7.2. HMI servo menu**

Setting	Values	Description
C: Servo connected	no	
S: Servo scanning	no	
P: Go to position	0.0 degrees	
M: Go to mid-point		
1: Minimum allowed pulse width	1000.0 us	
2: Maximum allowed pulse width	2000.0 us	
3: Angular scale	10.00 us per degree	
T: Scan type	bi-directional	
R: Steps per reading	4 = 0.27 degrees per reading	
L: Servo lag	0.00 degrees	
4: Field of view - lowest angle	-180.0 degrees	
5: Field of view - highest angle	180.0 degrees	
6: Alarm A - low angle	-90.0 degrees	
7: Alarm A - high angle	0.0 degrees	
8: Alarm B - low angle	0.0 degrees	
9: Alarm B - high angle	90.0 degrees	

**7.3. MMI commands set**

The LW20 has either a serial or an I2C communication port. Commands can be sent that read values, change settings, or alter the performance of the LW20. Distances are in meters and temperatures in degrees celsius.

Commands are sent and responses received in ASCII format (human readable). These ASCII strings have a maximum of 32 characters.

NOTE: There are some special commands to make the LW20 compatible with older systems and these are in binary format.

Once a command has been sent a single reply will be returned. To continuously update the reply without re-sending the command the streaming (\$) command can be used.

**Note**

The first command sent after power up will be used to detect if the LW20 is running in Serial or I2C mode, and therefore will not get a response.

Command string format:

<command type><channel><parameter><index><,><numeric value><CR><LF>

Command types:

- ? Read a value once. This can be either a result or a setting.
- # Change a setting. All settings can be changed.
- \$ Stream a value continuously. Update a result or a setting every time it changes.
- % Save a setting. The setting becomes permanent even after the power is switched off.

Channels:

- P Product channel - provides product specific information
- L Laser channel - provides distance measurements and related settings
- S Servo channel - relates to servo position and settings
- A Alarm channel - shows the status of alarms
- C Communications channel - handles serial and I2C settings

Examples:

- ?LDF,0 Read the median value of the distance to the first return signal
- #LO,0.23 Move the measurement zero datum further away by 0.23 meters
- \$1LT Stream the internal temperature in the first column
- %P Save all settings to permanent memory

**Command list**

Command	Typical return	Description
<b>Product channel commands</b>		
? ?P	p:SF20,1.0.0,11	Product name, firmware version, hardware version
?PN	pn:SF20	Product name
?PF	pf:11	Hardware version
?PS	ps:1.0.0	Firmware version
%P	%p:	Save all new settings to permanent memory
<b>Laser channel commands</b>		
?L ?LD	l:3.35 ld,0:23.67	Default raw distance Default median distance
?LDF ?LDF,0 ?LDF,1 ?LDF,2 ?LDF,3	ldf,0:56.98 ldf,0:45.32 ldf,1:32.78 ldf,2:65.12 ldf,3:34.23	Median distance to the first return Median distance to the first return Raw distance to the first return Closest distance to the first return Furthest distance to the first return
?LDL ?LDL,0 ?LDL,1 ?LDL,2 ?LDL,3	ldl,0:56.98 ldl,0:45.32 ldl,1:32.78 ldl,2:65.12 ldl,3:34.23	Median distance to the last return Median distance to the last return Raw distance to the last return Closest distance to the last return Furthest distance to the last return
?LH ?LHF ?LHL	lhf:100 lhf:100 lhl:78	Signal strength of first default signal (%) Signal strength of first return (%) Signal strength of last return (%)

?LO #LO,0.56	lo:0.14 lo:0.56	Read distance measurement datum offset Change to a new datum offset: Adjustment range = -10.00 ... 10.00
?LA ?LAA #LAA,5.00	laa:3.00 laa:3.00 laa:5.00	Read the first alarm distance Read the first alarm distance Change the first alarm distance: Adjustment range = 0.00 ... 100.00
?LAB #LAB,6.00	lab:3.00 lab:6.00	Read the second alarm distance Change the second alarm distance: Adjustment range = 0.00 ... 100.00
?LAH #LAH,0.05	lh:0.00 lh:0.05	Read the alarm hysteresis value Change the alarm hysteresis value: Adjustment range = 0.00 ... 10.00
?LM #LM,1	lm:5 lm:1	Check which measuring mode (update rate) is active Change to a new measuring mode (update rate): 1 = 388 readings per second 2 = 194 readings per second 3 = 129 readings per second 4 = 97 readings per second 5 = 78 readings per second 6 = 65 readings per second 7 = 55 readings per second 8 = 48 readings per second
?LF #LF,0	lf:1 lf:0	Check if the laser is running Change the laser state: 0 = laser is off 1 = laser is running
?LT	lt:35.7	Read the internal temperature
?LN	ln:0.5	Read the level of background noise
?LC #LC,16	lc:8 lc:16	Read the number of lost signal confirmations Change the number of lost signal confirmations: Adjustment range = 1 ... 250
%L	%!	Save all new settings to permanent memory
<b>Servo channel commands</b>		
?S ?SC #SC,1	s:0 sc:0 sc:1	Check if a servo is connected Check if a servo is connected Connect the servo
?SS #SS,1 \$1SS	ss:0 ss:1 ss:30.5,15.56,27.43	Check if the servo is scanning Turn on servo scanning Stream servo scanning data: ss:angle, first return, last return
?SP #SP,20.5	sp:0.0 sp:20.5	Read the current servo position in degrees Move the servo to a new position: Adjustment range = -180 ... 180
?SM #SM	sm:15.0 sm:0.0	Read the current servo position in degrees Move the servo to the middle position
?SWL #SWL,1100.0	swl:1000.0 swl:1100.0	Read the minimum allowed PWM time in us Change the minimum allowed PWM time: Adjustment range = 0.0 ... 2999.0
?SWH #SWH,1900	swh:2000.0 swh:1900.0	Read the maximum allowed PWM time in us Change the maximum allowed PWM time: Adjustment range = 0.0 ... 2999.0
?SWS #SWS,10.00	sws:9.00 sws:10.00	Read the us per degree scale of the servo Change the us per degree scale of the servo: Adjustment range = 0.1 ... 1000.0
?ST #ST,0	st:1 st:0	Read the type of scan being used Change the type of scan: 0 = bidirectional scan 1 = unidirectional scan
?SR #SR,8	sr:4 sr:8	Read the number of servo steps per reading Change the number of servo steps per reading: Adjustment range = 1 ... 32
?SL #SL,2.57	sl:1.32 sl:2.57	Read the servo lag angle in degrees Change the servo lag angle: Adjustment range = 0.00 ... 90.00
?SFL #SFL,-30.0	sfl:-45.0 sfl:-30.0	Read the lower angle of the field of view Change the lower angle of the field of view: Adjustment range = -180.0 ... 180.0



?SFH #SFH,30.0	sfh:45.0 sfh:30.0	Read the higher angle of the field of view Change the higher angle of the field of view: Adjustment range = -180.0 ... 180.0
?SAL #SAL,-15.0	sal:-45.0 sal:-15.0	Read the lower angle for alarm A Change the lower angle for alarm A: Adjustment range = -180.0 ... 180.0
?SAH #SAH,0.0	sah:45.0 sah:0.0	Read the higher angle for alarm A Change the higher angle for alarm A: Adjustment range = -180.0 ... 180.0
?SBL #SBL,0.0	sbl:-45.0 sbl:0.0	Read the lower angle for alarm B Change the lower angle for alarm B: Adjustment range = -180.0 ... 180.0
?SBH #SBH,15.0	sbh:45.0 sbh:15.0	Read the higher angle for alarm B Change the higher angle for alarm B: Adjustment range = -180.0 ... 180.0
%S	\$:	Save all new settings to permanent memory
<b>Alarm channel commands</b>		
?A ?AA ?AB	a:0,1 aa:0 ab:1	Read the states of both alarms Read the state of alarm A Read the state of alarm B
<b>Communications channel commands</b>		
?CB #CB,6	cb:7 cb:6	Read the serial port baud rate Change the serial port baud rate: 0 = 9600 1 = 19200 2 = 38400 3 = 57600 4 = 115200 5 = 230400 6 = 460800 7 = 921600
?CI #CI,0x78	ci:0x66 ci:0x78	Read the I2C address in hexadecimal Change the I2C address: Adjustment range = 0 ... 0x7F
%C	%c:	Save all new settings to permanent memory
<b>Legacy commands for the serial port</b>		
D' or 'd'	78.32	Output the current distance once only
?SU #SU,1	su:0 su:1	Check if distance streaming is active Switch distance streaming on or off: 0 = off 1 = on
0'	No response	Enable I2C legacy distance streaming
<b>Legacy commands for the I2C port</b>		
0' or 0 or 1 or 129	78.23	Enable output binary coded distance in centimeters Send any other command to disable

### Data streaming

The SF20 / LW20 can stream up to five read commands (?).

Set a stream using the format: <\$><stream num><,><parameter name><CR>

For example:

To stream the median distance to the first return, on stream one:     \$1,ldf<CR>

To stream the signal strength of first return, on stream two:         \$2,lhf<CR>

You can clear an individual stream by using:                     \$<stream num><CR>

You can clear all streams by sending \$<CR>

Streams are considered a settable parameter like any other in the LW20, therefore you can save the stream to persist through boot up. The command %p<CR> will save all settings.

Note: Saving parameters in the LW20 happens on flash memory, which has limited writes. This is not a problem for everyday use, but don't call the save command in a tight loop, as you could exhaust the flash if you accidentally call it a few hundred thousand times.



## 8. Revision history

Revision	Date	Comments
Rev 12	2020/09/23	Fix incorrect average Laser power, pulse frequency and NOHD distance in paragraph 5.2. Update FDA Accession number (page 4). Cable layout displayed on page 23 was incorrect
Rev 11	2020/05/22	Separated LW20 information from SF20. Updated branding and layout of this document has resulted in page number changes to previous revision history entries. Include "CE" certification. Converted to new layout to datasheet format. Updated power supply current to "100mA" (page 4). Removed housing details (page 4). Include HMI commands description table (page 21,22)
Rev 10	2019/11/28	include ce certification
Rev 9	2018/07/23	Included "Figure 30 :: Heat sink contact area" (page 22).
Rev 8	2018/07/04	Removed feature "Remove feature: "Encoded laser pulses prevent interference for other lasers" (pages 1, 6). Removed feature "Power saving mode to save energy when not in use" (page 1). Updated power supply current to "130 mA" (pages 5, 7). Added "Objects must be separated by approximately 5 meters before they are seen as separate return signals." (page 6). Include cautionary note "The SF20 is an OEM module that requires the customer to provide appropriate heat sinking and EMI shielding" (page 7). Changed "Select the "Laser" icon" to "Select the "Settings" icon" (page 8). Added new instruction "Press the up arrow to engage serial communication mode. The LW20 will reply with a product code" (page 11). Removed <-> key option to go back into machine-to-machine mode (page 11). Updated "Figure 12 :: Arrangement of screens in terminal emulation mode" (page 11). Update "The LW20 will wait for the first command to confirm which communication mode to select (serial or I2C). The first command will not get a response (page 15). Remove the "E - The Energy channel controls power usage" channel (pages 15, 24, 26). Remove the setting "Encoding pattern" from the table (page 16). Correct the serial port baud rate to "9600 ... 921600" (page 16). Updated "Figure 31 :: Pinout diagram" (page 23). Added note "The first command sent after power up will be used to detect if the LW20 is running in Serial or I2C mode, and therefore will not get a response" (page 24). Replace "%C - Save the latest communications settings to permanent memory" with "%P - Save all settings to permanent memory" (page 24). Updated "Command list" table (pages 24, 25, 26).
Rev 7	2018/04/26	Added new model variations for "LW20/B", "LW20/C", "SF20/B" and "SF20/C" to replace obsolete "LW20/SER", "LW20/I2C" and "SF20" models (pages 2, 7, 15). Units now ship a single I2C and serial communication cable (pages 7, 15, 17, 24). Updated "Figure 10 :: Connection to a USB converter cable" (page 11). Updated "Figure 4 :: Connection to a USB converter cable" (page 8) and "Figure 13 :: Connection to a Devantech USB-ISS module" (page 13). Removed sentences "5 V logic should also work without any level shifters." and "In some cases, 5 V logic will also work but this is not guaranteed." (page 15). Included cautionary note "Ensure that adequate ventilation or heat sinking is provided if the SF20 is incorporated into a custom enclosure, as heat build-up could occur." (page 22). Removed "Figure 31 :: I2C and power cable". Updated "Figure 31 :: Pinout diagram" by removing reference to "or 5 V logic" on RXD pin (page 22).
Rev 6	2018/04/05	Updated "4. Specifications of the LW20 / SF20" item "Range" to "0.2 ... 100 m (sunlit white wall, 45 readings per second)" (pages 4, 5). "4. Specifications of the LW20 / SF20" item "Beam divergence" to "0.3°" (page 5). Updated "Figure 13 :: Connection to a Devantech USB-ISS module" to reflect an LW20/I2C model (page 11).
Rev 5	2017/07/27	Added "Figure 32 :: Pinout diagram (page 22).
Rev 4	2017/05/25	Highlighted the factory default I2C bus address as 0x66 (pages 12, 14). Highlighted the factory default serial baud rate as 115200 (page 12).
Rev 3	2017/05/05	Changed baud rate setting from 921600 to 115200 (pages 6, 9). Updated "Figure 13 :: Connection to a Devantech USB-ISS module" (page 11). Updated LightWare Terminal screens to version 1.3.1 (pages 6, 9, 10, 11, 14). Included "Data streaming" section into "Appendix C" (page 25).
Rev 2	2017/04/10	Include new section "6.1 How to communicate with the LW20 using the Devantech USB to I2C module" (pages 11, 12).
Rev 1	2017/03/03	Updated "4. Specifications of the LW20 / SF20" to include the approval "FDA: 1710193-000 (2017/02)" (page 5). Update "Figure 26 :: Serial and power cable" (Rev 2) and "Figure 27 :: I2C and power cable" (Rev 2) to include a Ferrite Core component (page 19).
Rev 0	2017/02/20	First edition