



PIC18F2423/2523/4423/4523

Data Sheet

28/40/44-Pin, Enhanced Flash
Microcontrollers with 12-Bit A/D
and nanoWatt Technology

Note the following details of the code protection feature on Microchip devices:

- Microchip products meet the specification contained in their particular Microchip Data Sheet.
- Microchip believes that its family of products is one of the most secure families of its kind on the market today, when used in the intended manner and under normal conditions.
- There are dishonest and possibly illegal methods used to breach the code protection feature. All of these methods, to our knowledge, require using the Microchip products in a manner outside the operating specifications contained in Microchip's Data Sheets. Most likely, the person doing so is engaged in theft of intellectual property.
- Microchip is willing to work with the customer who is concerned about the integrity of their code.
- Neither Microchip nor any other semiconductor manufacturer can guarantee the security of their code. Code protection does not mean that we are guaranteeing the product as "unbreakable."

Code protection is constantly evolving. We at Microchip are committed to continuously improving the code protection features of our products. Attempts to break Microchip's code protection feature may be a violation of the Digital Millennium Copyright Act. If such acts allow unauthorized access to your software or other copyrighted work, you may have a right to sue for relief under that Act.

Information contained in this publication regarding device applications and the like is provided only for your convenience and may be superseded by updates. It is your responsibility to ensure that your application meets with your specifications. MICROCHIP MAKES NO REPRESENTATIONS OR WARRANTIES OF ANY KIND WHETHER EXPRESS OR IMPLIED, WRITTEN OR ORAL, STATUTORY OR OTHERWISE, RELATED TO THE INFORMATION, INCLUDING BUT NOT LIMITED TO ITS CONDITION, QUALITY, PERFORMANCE, MERCHANTABILITY OR FITNESS FOR PURPOSE. Microchip disclaims all liability arising from this information and its use. Use of Microchip devices in life support and/or safety applications is entirely at the buyer's risk, and the buyer agrees to defend, indemnify and hold harmless Microchip from any and all damages, claims, suits, or expenses resulting from such use. No licenses are conveyed, implicitly or otherwise, under any Microchip intellectual property rights.

Trademarks

The Microchip name and logo, the Microchip logo, dsPIC, KEELOQ, KEELOQ logo, MPLAB, PIC, PICmicro, PICSTART, rPIC and UNI/O are registered trademarks of Microchip Technology Incorporated in the U.S.A. and other countries.

FilterLab, Hampshire, HI-TECH C, Linear Active Thermistor, MXDEV, MXLAB, SEEVAL and The Embedded Control Solutions Company are registered trademarks of Microchip Technology Incorporated in the U.S.A.

Analog-for-the-Digital Age, Application Maestro, CodeGuard, dsPICDEM, dsPICDEM.net, dsPICworks, dsSPEAK, ECAN, ECONOMONITOR, FanSense, HI-TIDE, In-Circuit Serial Programming, ICSP, Mindi, MiWi, MPASM, MPLAB Certified logo, MPLIB, MPLINK, mTouch, Octopus, Omniscient Code Generation, PICC, PICC-18, PICDEM, PICDEM.net, PICKit, PICTail, PIC³² logo, REAL ICE, rLAB, Select Mode, Total Endurance, TSHARC, UniWinDriver, WiperLock and ZENA are trademarks of Microchip Technology Incorporated in the U.S.A. and other countries.

SQTP is a service mark of Microchip Technology Incorporated in the U.S.A.

All other trademarks mentioned herein are property of their respective companies.

© 2009, Microchip Technology Incorporated, Printed in the U.S.A., All Rights Reserved.

 Printed on recycled paper.

QUALITY MANAGEMENT SYSTEM
CERTIFIED BY DNV
== ISO/TS 16949:2002 ==

Microchip received ISO/TS-16949:2002 certification for its worldwide headquarters, design and wafer fabrication facilities in Chandler and Tempe, Arizona; Gresham, Oregon and design centers in California and India. The Company's quality system processes and procedures are for its PIC[®] MCUs and dsPIC[®] DSCs, KEELOQ[®] code hopping devices, Serial EEPROMs, microperipherals, nonvolatile memory and analog products. In addition, Microchip's quality system for the design and manufacture of development systems is ISO 9001:2000 certified.



MICROCHIP

PIC18F2423/2523/4423/4523

28/40/44-Pin, Enhanced Flash Microcontrollers with 12-Bit A/D and nanoWatt Technology

Power Management Features:

- Run: CPU on, Peripherals on
- Idle: CPU off, Peripherals on
- Sleep: CPU off, Peripherals off
- Ultra Low 50 nA Input Leakage
- Run mode Currents Down to 11 μ A Typical
- Idle mode Currents Down to 2.5 μ A Typical
- Sleep mode Current Down to 100 μ A Typical
- Timer1 Oscillator: 900 nA, 32 kHz, 2V
- Watchdog Timer: 1.4 μ A, 2V Typical
- Two-Speed Oscillator Start-up

Flexible Oscillator Structure:

- Four Crystal modes, up to 40 MHz
- 4x Phase Lock Loop (PLL) – Available for Crystal and Internal Oscillators
- Two External RC modes, up to 4 MHz
- Two External Clock modes, up to 40 MHz
- Internal Oscillator Block:
 - Fast wake from Sleep and Idle, 1 μ s typical
 - 8 user-selectable frequencies, from 31 kHz to 8 MHz
 - Provides a complete range of clock speeds, from 31 kHz to 32 MHz, when used with PLL
 - User-tunable to Compensate for Frequency Drift
- Secondary Oscillator using Timer1 @ 32 kHz
- Fail-Safe Clock Monitor:
 - Allows for safe shutdown if peripheral clock stops

Peripheral Highlights:

- 12-Bit, Up to 13-Channel Analog-to-Digital Converter module (A/D):
 - Auto-acquisition capability
 - Conversion available during Sleep mode
- Dual Analog Comparators with Input Multiplexing
- High-Current Sink/Source 25 mA/25 mA
- Three Programmable External Interrupts
- Four Input Change Interrupts
- Up to Two Capture/Compare/PWM (CCP) modules, One with Auto-Shutdown (28-pin devices)
- Enhanced Capture/Compare/PWM (ECCP) module (40/44-pin devices only):
 - One, two or four PWM outputs
 - Selectable polarity
 - Programmable dead time
 - Auto-shutdown and auto-restart

Peripheral Highlights (Continued):

- Master Synchronous Serial Port (MSSP) module Supporting 3-Wire SPI (all four modes) and I²C™ Master and Slave modes
- Enhanced USART module:
 - Support for RS-485, RS-232 and LIN/J2602
 - RS-232 operation using internal oscillator block (no external crystal required)
 - Auto-wake-up on Start bit
 - Auto-Baud Detect (ABD)

Special Microcontroller Features:

- C Compiler Optimized Architecture: Optional Extended Instruction Set Designed to Optimize Re-Entrant Code
- 100,000 Erase/Write Cycle, Enhanced Flash Program Memory Typical
- 1,000,000 Erase/Write Cycle, Data EEPROM Memory Typical
- Flash/Data EEPROM Retention: 100 Years Typical
- Self-Programmable under Software Control
- Priority Levels for Interrupts
- 8 x 8 Single-Cycle Hardware Multiplier
- Extended Watchdog Timer (WDT): Programmable Period, from 4 ms to 131s
- Single-Supply In-Circuit Serial Programming™ (ICSP™) via Two Pins
- In-Circuit Debug (ICD) via Two Pins
- Operating Voltage Range: 2.0V to 5.5V
- Programmable, 16-Level High/Low-Voltage Detection (HLVD) module: Supports Interrupt on High/Low-Voltage Detection
- Programmable Brown-out Reset (BOR): With Software-Enable Option

Note: This document is supplemented by the "PIC18F2420/2520/4420/4520 Data Sheet" (DS39631). See **Section 1.0 "Device Overview"**.

Device	Program Memory		Data Memory		I/O	12-Bit A/D (ch)	CCP/ECCP (PWM)	MSSP		EUSART	Comp.	Timers 8/16-Bit
	Flash (bytes)	# Single-Word Instructions	SRAM (bytes)	EEPROM (bytes)				SPI	Master I ² C™			
PIC18F2423	16K	8192	768	256	25	10	2/0	Y	Y	1	2	1/3
PIC18F2523	32K	16384	1536	256	25	10	2/0	Y	Y	1	2	1/3
PIC18F4423	16K	8192	768	256	36	13	1/1	Y	Y	1	2	1/3
PIC18F4523	32K	16384	1536	256	36	13	1/1	Y	Y	1	2	1/3

PIC18F2423/2523/4423/4523

Pin Diagrams

28-Pin PDIP, SOIC

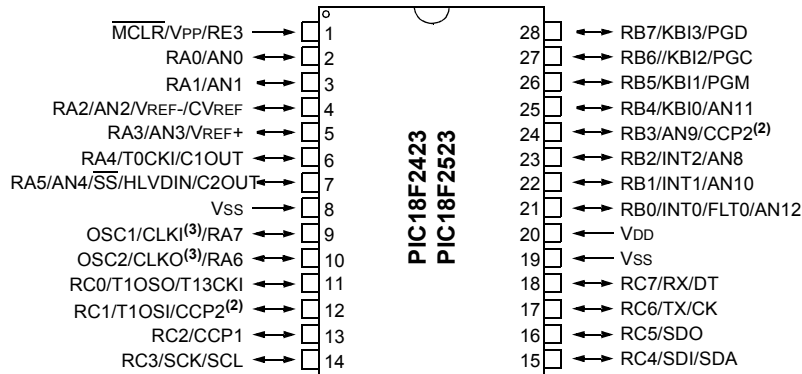

28-Pin QFN⁽¹⁾



- Note 1:** It is recommended to connect the bottom pad of QFN package parts to Vss.
Note 2: RB3 is the alternate pin for CCP2 multiplexing.
Note 3: OSC1/CLKI and OSC2/CLKO are only available in select oscillator modes and when these pins are not being used as digital I/O. For additional information, see **Section 2.0 "Oscillator Configurations"** of the "PIC18F2420/2520/4420/4520 Data Sheet" (DS39631).

PIC18F2423/2523/4423/4523

Pin Diagrams (Continued)

40-Pin PDIP

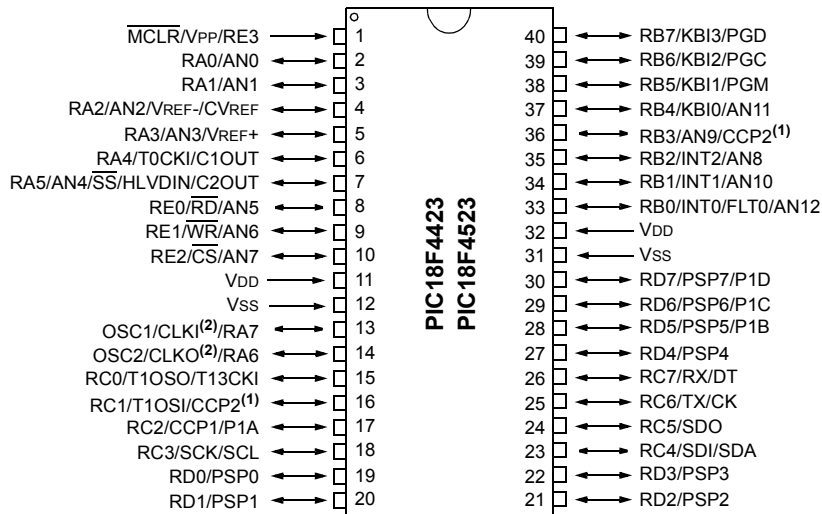

44-Pin TQFP

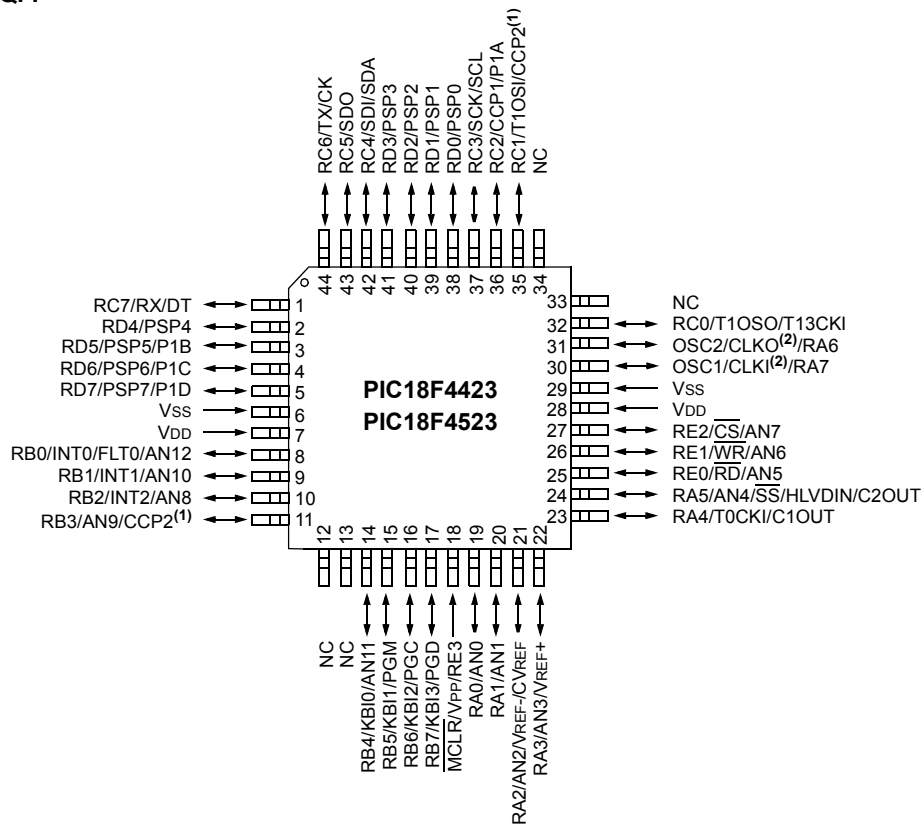

Note 1: RB3 is the alternate pin for CCP2 multiplexing.

Note 2: OSC1/CLKI and OSC2/CLKO are only available in select oscillator modes and when these pins are not being used as digital I/O. For additional information, see **Section 2.0 "Oscillator Configurations"** of the "PIC18F2420/2520/4420/4520 Data Sheet" (DS39631).

PIC18F2423/2523/4423/4523

Pin Diagrams (Continued)

44-Pin QFN⁽¹⁾



- Note 1:** It is recommended to connect the bottom pad of QFN package parts to Vss.
- Note 2:** RB3 is the alternate pin for CCP2 multiplexing.
- Note 3:** OSC1/CLKI and OSC2/CLKO are only available in select oscillator modes and when these pins are not being used as digital I/O. For additional information, see **Section 2.0 "Oscillator Configurations"** of the "PIC18F2420/2520/4420/4520 Data Sheet" (DS39631).

PIC18F2423/2523/4423/4523

Table of Contents

1.0	Device Overview	9
2.0	12-Bit Analog-to-Digital Converter (A/D) Module	25
3.0	Special Features of the CPU	35
4.0	Electrical Characteristics	37
5.0	Packaging Information.....	43
	Appendix A: Revision History.....	45
	Appendix B: Device Differences	45
	Appendix C: Conversion Considerations	46
	Appendix D: Migration from Baseline to Enhanced Devices.....	46
	Appendix E: Migration from Mid-Range to Enhanced Devices	47
	Appendix F: Migration from High-End to Enhanced Devices.....	47
	Index	49
	The Microchip Web Site	51
	Customer Change Notification Service	51
	Customer Support.....	51
	Reader Response	52
	Product Identification System	53

TO OUR VALUED CUSTOMERS

It is our intention to provide our valued customers with the best documentation possible to ensure successful use of your Microchip products. To this end, we will continue to improve our publications to better suit your needs. Our publications will be refined and enhanced as new volumes and updates are introduced.

If you have any questions or comments regarding this publication, please contact the Marketing Communications Department via E-mail at docerrors@microchip.com or fax the **Reader Response Form** in the back of this data sheet to (480) 792-4150. We welcome your feedback.

Most Current Data Sheet

To obtain the most up-to-date version of this data sheet, please register at our Worldwide Web site at:

<http://www.microchip.com>

You can determine the version of a data sheet by examining its literature number found on the bottom outside corner of any page. The last character of the literature number is the version number, (e.g., DS30000A is version A of document DS30000).

Errata

An errata sheet, describing minor operational differences from the data sheet and recommended workarounds, may exist for current devices. As device/documentation issues become known to us, we will publish an errata sheet. The errata will specify the revision of silicon and revision of document to which it applies.

To determine if an errata sheet exists for a particular device, please check with one of the following:

- Microchip's Worldwide Web site; <http://www.microchip.com>
- Your local Microchip sales office (see last page)

When contacting a sales office, please specify which device, revision of silicon and data sheet (include literature number) you are using.

Customer Notification System

Register on our web site at www.microchip.com to receive the most current information on all of our products.

PIC18F2423/2523/4423/4523

1.0 DEVICE OVERVIEW

This document contains device-specific information for the following devices:

- PIC18F2423
- PIC18F2523
- PIC18F4423
- PIC18F4523
- PIC18LF2423
- PIC18LF2523
- PIC18LF4423
- PIC18LF4523

Note: This data sheet documents only the devices' features and specifications that are in addition to, or different from, the features and specifications of the PIC18F2420/2520/4420/4520 devices. For information on the features and specifications shared by the PIC18F2423/2523/4423/4523 and PIC18F2420/2520/4420/4520 devices, see the "PIC18F2420/2520/4420/4520 Data Sheet" (DS39631).

This family offers the advantages of all PIC18 microcontrollers – namely, high computational performance at an economical price – with the addition of high-endurance, Enhanced Flash program memory. On top of these features, the PIC18F2423/2523/4423/4523 family introduces design enhancements that make these microcontrollers a logical choice for many high-performance, power-sensitive applications.

1.1 New Core Features

1.1.1 nanoWatt TECHNOLOGY

All of the devices in the PIC18F2423/2523/4423/4523 family incorporate a range of features that can significantly reduce power consumption during operation. Key items include:

- **Alternate Run Modes:** By clocking the controller from the Timer1 source or the internal oscillator block, power consumption during code execution can be reduced by as much as 90%.
- **Multiple Idle Modes:** The controller also can run with its CPU core disabled and the peripherals still active. In these states, power consumption can be reduced even further, to as little as 4% of normal operation requirements.
- **On-the-Fly Mode Switching:** The power-managed modes are invoked by user code during operation, allowing the user to incorporate power-saving ideas into their application's software design.
- **Low Consumption in Key Modules:** The power requirements for both Timer1 and the Watchdog Timer are minimized. See **Section 4.0 "Electrical Characteristics"** for values.

1.1.2 MULTIPLE OSCILLATOR OPTIONS AND FEATURES

All of the devices in the PIC18F2423/2523/4423/4523 family offer ten different oscillator options, allowing users a wide range of choices in developing application hardware. These include:

- Four Crystal modes, using crystals or ceramic resonators.
- Two External Clock modes, offering the option of using two pins (oscillator input and a divide-by-4 clock output) or one pin (oscillator input, with the second pin reassigned as general I/O).
- Two External RC Oscillator modes with the same pin options as the External Clock modes.
- An internal oscillator block that offers eight clock frequencies: an 8 MHz clock and an INTRC source (approximately 31 kHz), as well as a range of six user-selectable clock frequencies, between 125 kHz to 4 MHz. This option frees the two oscillator pins for use as additional general purpose I/O.
- A Phase Lock Loop (PLL) frequency multiplier, available to both the High-Speed Crystal and Internal Oscillator modes, allowing clock speeds of up to 40 MHz from the HS clock source. Used with the internal oscillator, the PLL gives users a complete selection of clock speeds, from 31 kHz to 32 MHz, all without using an external crystal or clock circuit.

Besides its availability as a clock source, the internal oscillator block provides a stable reference source that gives the family additional features for robust operation:

- **Fail-Safe Clock Monitor:** Constantly monitors the main clock source against a reference signal provided by the internal oscillator. If a clock failure occurs, the controller is switched to the internal oscillator block, allowing for continued operation or a safe application shutdown.
- **Two-Speed Start-up:** Allows the internal oscillator to serve as the clock source from Power-on Reset, or wake-up from Sleep mode, until the primary clock source is available.

PIC18F2423/2523/4423/4523

1.2 Other Special Features

- **12-Bit A/D Converter:** This module incorporates programmable acquisition time, allowing for a channel to be selected and a conversion to be initiated without waiting for a sampling period, thereby reducing code overhead.
- **Memory Endurance:** The Enhanced Flash cells for both program memory and data EEPROM are rated to last for many thousands of erase/write cycles – up to 100,000 for program memory and 1,000,000 for EEPROM. Data retention without refresh is conservatively estimated to be greater than 40 years.
- **Self-Programmability:** These devices can write to their own program memory spaces under internal software control. By using a bootloader routine located in the protected Boot Block at the top of program memory, it is possible to create an application that can update itself in the field.
- **Extended Instruction Set:** The PIC18F2423/2523/4423/4523 family introduces an optional extension to the PIC18 instruction set that adds eight new instructions and an Indexed Addressing mode. This extension, enabled as a device configuration option, has been specifically designed to optimize re-entrant application code originally developed in high-level languages, such as C.
- **Enhanced CCP module:** In PWM mode, this module provides one, two or four modulated outputs for controlling half-bridge and full-bridge drivers. Other features include auto-shutdown, for disabling PWM outputs on interrupt or other select conditions, and auto-restart, to reactivate outputs once the condition has cleared.
- **Enhanced Addressable USART:** This serial communication module is capable of standard RS-232 operation and provides support for the LIN/J2602 bus protocol. Other enhancements include automatic baud rate detection and a 16-bit Baud Rate Generator for improved resolution. When the microcontroller is using the internal oscillator block, the EUSART provides stable operation for applications that talk to the outside world without using an external crystal (or its accompanying power requirement).
- **Extended Watchdog Timer (WDT):** This Enhanced version incorporates a 16-bit prescaler, allowing an extended time-out range that is stable across operating voltage and temperature. See **Section 4.0 “Electrical Characteristics”** for time-out periods.

1.3 Details on Individual Family Members

Devices in the PIC18F2423/2523/4423/4523 family are available in 28-pin and 40/44-pin packages. Block diagrams for the two groups are shown in Figure 1-1 and Figure 1-2.

The devices are differentiated from each other in these ways:

- Flash Program Memory:
 - PIC18F2423/4423 devices – 16 Kbytes
 - PIC18F2523/4523 devices – 32 Kbytes
- A/D Channels:
 - PIC18F2423/2523 devices – 10
 - PIC18F4423/4523 devices – 13
- I/O Ports:
 - PIC18F2423/2523 devices – Three bidirectional ports
 - PIC18F4423/4523 devices – Five bidirectional ports
- CCP and Enhanced CCP Implementation:
 - PIC18F2423/2523 devices – Two standard CCP modules
 - PIC18F4423/4523 devices – One standard CCP module and one ECCP module
- Parallel Slave Port – Present only on PIC18F4423/4523 devices

All other features for devices in this family are identical. These are summarized in Table 1-1.

The pinouts for all devices are listed in Table 1-2 and Table 1-3.

Members of the PIC18F2423/2523/4423/4523 family are available only as low-voltage devices, designated by “LF” (such as PIC18**LF**2423), and function over an extended VDD range of 2.0V to 5.5V.

PIC18F2423/2523/4423/4523

TABLE 1-1: DEVICE FEATURES

Features	PIC18F2423	PIC18F2523	PIC18F4423	PIC18F4523
Operating Frequency	DC – 40 MHz	DC – 40 MHz	DC – 40 MHz	DC – 40 MHz
Program Memory (Bytes)	16,384	32,768	16,384	32,768
Program Memory (Instructions)	8,192	16,384	8,192	16,384
Data Memory (Bytes)	768	1,536	768	1,536
Data EEPROM Memory (Bytes)	256	256	256	256
Interrupt Sources	19	19	20	20
I/O Ports	Ports A, B, C, (E)	Ports A, B, C, (E)	Ports A, B, C, D, E	Ports A, B, C, D, E
Timers	4	4	4	4
Capture/Compare/PWM Modules	2	2	1	1
Enhanced Capture/Compare/PWM Modules	0	0	1	1
Serial Communications	MSSP, Enhanced USART	MSSP, Enhanced USART	MSSP, Enhanced USART	MSSP, Enhanced USART
Parallel Communications (PSP)	No	No	Yes	Yes
12-Bit Analog-to-Digital Module	10 Input Channels	10 Input Channels	13 Input Channels	13 Input Channels
Resets (and Delays)	POR, BOR, RESET Instruction, Stack Full, Stack Underflow (PWRT, OST), MCLR (optional), WDT	POR, BOR, RESET Instruction, Stack Full, Stack Underflow (PWRT, OST), MCLR (optional), WDT	POR, BOR, RESET Instruction, Stack Full, Stack Underflow (PWRT, OST), MCLR (optional), WDT	POR, BOR, RESET Instruction, Stack Full, Stack Underflow (PWRT, OST), MCLR (optional), WDT
Programmable High/Low-Voltage Detect	Yes	Yes	Yes	Yes
Programmable Brown-out Reset	Yes	Yes	Yes	Yes
Instruction Set	75 Instructions; 83 with Extended Instruction Set enabled	75 Instructions; 83 with Extended Instruction Set enabled	75 Instructions; 83 with Extended Instruction Set enabled	75 Instructions; 83 with Extended Instruction Set enabled
Packages	28-Pin PDIP 28-Pin SOIC 28-Pin QFN	28-Pin PDIP 28-Pin SOIC 28-Pin QFN	40-Pin PDIP 44-Pin QFN 44-Pin TQFP	40-Pin PDIP 44-Pin QFN 44-Pin TQFP

PIC18F2423/2523/4423/4523

FIGURE 1-1: PIC18F2423/2523 (28-PIN) BLOCK DIAGRAM



PIC18F2423/2523/4423/4523

FIGURE 1-2: PIC18F4423/4523 (40/44-PIN) BLOCK DIAGRAM



PIC18F2423/2523/4423/4523

TABLE 1-3: PIC18F4423/4523 PINOUT I/O DESCRIPTIONS

Pin Name	Pin Number			Pin Type	Buffer Type	Description
	PDIP	QFN	TQFP			
MCLR/VPP/RE3 MCLR VPP RE3	1	18	18	I P I	ST ST	Master Clear (input) or programming voltage (input). Master Clear (Reset) input. This pin is an active-low Reset to the device. Programming voltage input. Digital input.
OSC1/CLKI/RA7 OSC1 CLKI RA7	13	32	30	I I I/O	ST CMOS TTL	Oscillator crystal or external clock input. Oscillator crystal input or external clock source input. ST buffer when configured in RC mode; analog otherwise. External clock source input. Always associated with pin function, OSC1. (See related OSC1/CLKI, OSC2/CLKO pins.) General purpose I/O pin.
OSC2/CLKO/RA6 OSC2 CLKO RA6	14	33	31	O O I/O	— — TTL	Oscillator crystal or clock output. Oscillator crystal output. Connects to crystal or resonator in Crystal Oscillator mode. In RC mode, OSC2 pin outputs CLKO, which has 1/4 the frequency of OSC1 and denotes the instruction cycle rate. General purpose I/O pin.

Legend: TTL = TTL compatible input CMOS = CMOS compatible input or output
 ST = Schmitt Trigger input with CMOS levels I = Input
 O = Output P = Power
 I²C = I²C™/SMBus

Note 1: Default assignment for CCP2 when Configuration bit, CCP2MX, is set.
2: Alternate assignment for CCP2 when Configuration bit, CCP2MX, is cleared.

PIC18F2423/2523/4423/4523

TABLE 1-3: PIC18F4423/4523 PINOUT I/O DESCRIPTIONS (CONTINUED)

Pin Name	Pin Number			Pin Type	Buffer Type	Description	
	PDIP	QFN	TQFP				
RA0/AN0	2	19	19	I/O	TTL	PORTA is a bidirectional I/O port. Digital I/O.	
RA0				I	Analog		Analog Input 0.
AN0							
RA1/AN1	3	20	20	I/O	TTL	Digital I/O.	
RA1				I	Analog		Analog Input 1.
AN1							
RA2/AN2/VREF-/CVREF	4	21	21	I/O	TTL	Digital I/O.	
RA2				I	Analog		Analog Input 2.
AN2				I	Analog		A/D reference voltage (low) input.
VREF-				O	Analog		Comparator reference voltage output.
CVREF							
RA3/AN3/VREF+	5	22	22	I/O	TTL	Digital I/O.	
RA3				I	Analog		Analog Input 3.
AN3				I	Analog		A/D reference voltage (high) input.
VREF+							
RA4/T0CKI/C1OUT	6	23	23	I/O	ST	Digital I/O.	
RA4				I	ST		Timer0 external clock input.
T0CKI				O	—		Comparator 1 output.
C1OUT							
RA5/AN4/SS/HLVDIN/C2OUT	7	24	24	I/O	TTL	Digital I/O.	
RA5				I	Analog		Analog Input 4.
AN4				I	TTL		SPI slave select input.
SS				I	Analog		High/Low-Voltage Detect input.
HLVDIN				O	—		Comparator 2 output.
C2OUT							
RA6						See the OSC2/CLKO/RA6 pin.	
RA7						See the OSC1/CLKI/RA7 pin.	

Legend: TTL = TTL compatible input
 ST = Schmitt Trigger input with CMOS levels
 O = Output
 I²C = I²C™/SMBus
 CMOS = CMOS compatible input or output
 I = Input
 P = Power

- Note 1:** Default assignment for CCP2 when Configuration bit, CCP2MX, is set.
2: Alternate assignment for CCP2 when Configuration bit, CCP2MX, is cleared.

PIC18F2423/2523/4423/4523

TABLE 1-3: PIC18F4423/4523 PINOUT I/O DESCRIPTIONS (CONTINUED)

Pin Name	Pin Number			Pin Type	Buffer Type	Description
	PDIP	QFN	TQFP			
RB0/INT0/FLT0/AN12	33	9	8	I/O	TTL	PORTB is a bidirectional I/O port. PORTB can be software programmed for internal weak pull-ups on all inputs. Digital I/O. External Interrupt 0. PWM Fault input for Enhanced CCP1. Analog Input 12.
RB0				I	ST	
INT0				I	ST	
FLT0				I	Analog	
AN12				I	Analog	
RB1/INT1/AN10	34	10	9	I/O	TTL	Digital I/O. External Interrupt 1. Analog Input 10.
RB1				I	ST	
INT1				I	Analog	
AN10						
RB2/INT2/AN8	35	11	10	I/O	TTL	Digital I/O. External Interrupt 2. Analog Input 8.
RB2				I	ST	
INT2				I	Analog	
AN8						
RB3/AN9/CCP2	36	12	11	I/O	TTL	Digital I/O. Analog Input 9. Capture 2 input/Compare 2 output/PWM2 output.
RB3				I	Analog	
AN9				I/O	ST	
CCP2 ⁽¹⁾						
RB4/KBI0/AN11	37	14	14	I/O	TTL	Digital I/O. Interrupt-on-change pin. Analog Input 11.
RB4				I	TTL	
KBI0				I	Analog	
AN11						
RB5/KBI1/PGM	38	15	15	I/O	TTL	Digital I/O. Interrupt-on-change pin. Low-Voltage ICSP™ Programming enable pin.
RB5				I	TTL	
KBI1				I/O	ST	
PGM						
RB6/KBI2/PGC	39	16	16	I/O	TTL	Digital I/O. Interrupt-on-change pin. In-Circuit Debugger and ICSP programming clock pin.
RB6				I	TTL	
KBI2				I/O	ST	
PGC						
RB7/KBI3/PGD	40	17	17	I/O	TTL	Digital I/O. Interrupt-on-change pin. In-Circuit Debugger and ICSP programming data pin.
RB7				I	TTL	
KBI3				I/O	ST	
PGD						

Legend: TTL = TTL compatible input CMOS = CMOS compatible input or output
 ST = Schmitt Trigger input with CMOS levels I = Input
 O = Output P = Power
 I²C = I²C™/SMBus

Note 1: Default assignment for CCP2 when Configuration bit, CCP2MX, is set.
2: Alternate assignment for CCP2 when Configuration bit, CCP2MX, is cleared.

PIC18F2423/2523/4423/4523

TABLE 1-3: PIC18F4423/4523 PINOUT I/O DESCRIPTIONS (CONTINUED)

Pin Name	Pin Number			Pin Type	Buffer Type	Description
	PDIP	QFN	TQFP			
RC0/T1OSO/T13CKI	15	34	32			PORTC is a bidirectional I/O port.
RC0				I/O	ST	Digital I/O.
T1OSO				O	—	Timer1 oscillator output.
T13CKI				I	ST	Timer1/Timer3 external clock input.
RC1/T1OSI/CCP2	16	35	35			
RC1				I/O	ST	Digital I/O.
T1OSI				I	CMOS	Timer1 oscillator input.
CCP2 ⁽²⁾				I/O	ST	Capture 2 input/Compare 2 output/PWM2 output.
RC2/CCP1/P1A	17	36	36			
RC2				I/O	ST	Digital I/O.
CCP1				I/O	ST	Capture 1 input/Compare 1 output/PWM1 output.
P1A				O	—	Enhanced CCP1 output.
RC3/SCK/SCL	18	37	37			
RC3				I/O	ST	Digital I/O.
SCK				I/O	ST	Synchronous serial clock input/output for SPI mode.
SCL				I/O	I ² C	Synchronous serial clock input/output for I ² C™ mode.
RC4/SDI/SDA	23	42	42			
RC4				I/O	ST	Digital I/O.
SDI				I	ST	SPI data in.
SDA				I/O	I ² C	I ² C data I/O.
RC5/SDO	24	43	43			
RC5				I/O	ST	Digital I/O.
SDO				O	—	SPI data out.
RC6/TX/CK	25	44	44			
RC6				I/O	ST	Digital I/O.
TX				O	—	EUSART asynchronous transmit.
CK				I/O	ST	EUSART synchronous clock (see related RX/DT).
RC7/RX/DT	26	1	1			
RC7				I/O	ST	Digital I/O.
RX				I	ST	EUSART asynchronous receive.
DT				I/O	ST	EUSART synchronous data (see related TX/CK).

Legend: TTL = TTL compatible input
 ST = Schmitt Trigger input with CMOS levels
 O = Output
 I²C = I²C™/SMBus
 CMOS = CMOS compatible input or output
 I = Input
 P = Power

- Note 1:** Default assignment for CCP2 when Configuration bit, CCP2MX, is set.
2: Alternate assignment for CCP2 when Configuration bit, CCP2MX, is cleared.

PIC18F2423/2523/4423/4523

TABLE 1-3: PIC18F4423/4523 PINOUT I/O DESCRIPTIONS (CONTINUED)

Pin Name	Pin Number			Pin Type	Buffer Type	Description
	PDIP	QFN	TQFP			
RD0/PSP0 RD0 PSP0	19	38	38	I/O I/O	ST TTL	PORTD is a bidirectional I/O port or a Parallel Slave Port (PSP) for interfacing to a microprocessor port. These pins have TTL input buffers when the PSP module is enabled. Digital I/O. Parallel Slave Port data.
RD1/PSP1 RD1 PSP1	20	39	39	I/O I/O	ST TTL	Digital I/O. Parallel Slave Port data.
RD2/PSP2 RD2 PSP2	21	40	40	I/O I/O	ST TTL	Digital I/O. Parallel Slave Port data.
RD3/PSP3 RD3 PSP3	22	41	41	I/O I/O	ST TTL	Digital I/O. Parallel Slave Port data.
RD4/PSP4 RD4 PSP4	27	2	2	I/O I/O	ST TTL	Digital I/O. Parallel Slave Port data.
RD5/PSP5/P1B RD5 PSP5 P1B	28	3	3	I/O I/O O	ST TTL —	Digital I/O. Parallel Slave Port data. Enhanced CCP1 output.
RD6/PSP6/P1C RD6 PSP6 P1C	29	4	4	I/O I/O O	ST TTL —	Digital I/O. Parallel Slave Port data. Enhanced CCP1 output.
RD7/PSP7/P1D RD7 PSP7 P1D	30	5	5	I/O I/O O	ST TTL —	Digital I/O. Parallel Slave Port data. Enhanced CCP1 output.

Legend: TTL = TTL compatible input CMOS = CMOS compatible input or output
 ST = Schmitt Trigger input with CMOS levels I = Input
 O = Output P = Power
 I²C = I²C™/SMBus

Note 1: Default assignment for CCP2 when Configuration bit, CCP2MX, is set.
2: Alternate assignment for CCP2 when Configuration bit, CCP2MX, is cleared.

PIC18F2423/2523/4423/4523

NOTES:

PIC18F2423/2523/4423/4523

2.0 12-BIT ANALOG-TO-DIGITAL CONVERTER (A/D) MODULE

The Analog-to-Digital (A/D) Converter module has 10 inputs for the PIC18F2423/2523 devices and 13 for the PIC18F4423/4523 devices. This module allows conversion of an analog input signal to a corresponding 12-bit digital number.

The module has five registers:

- A/D Result High Register (ADRESH)
- A/D Result Low Register (ADRESL)
- A/D Control Register 0 (ADCON0)
- A/D Control Register 1 (ADCON1)
- A/D Control Register 2 (ADCON2)

Of the ADCONx registers:

- ADCON0 (shown in Register 2-1) – Controls the module's operation
- ADCON1 (Register 2-2) – Configures the functions of the port pins
- ADCON2 (Register 2-3) – Configures the A/D clock source, programmed acquisition time and justification

REGISTER 2-1: ADCON0: A/D CONTROL REGISTER 0

U-0	U-0	R/W-0	R/W-0	R/W-0	R/W-0	R/W-0	R/W-0
—	—	CHS3	CHS2	CHS1	CHS0	GO/DONE	ADON
bit 7							bit 0

Legend:

R = Readable bit	W = Writable bit	U = Unimplemented bit, read as '0'
-n = Value at POR	'1' = Bit is set	'0' = Bit is cleared
		x = Bit is unknown

bit 7-6 **Unimplemented:** Read as '0'

bit 5-2 **CHS<3:0>:** Analog Channel Select bits

0000 = Channel 0 (AN0)
 0001 = Channel 1 (AN1)
 0010 = Channel 2 (AN2)
 0011 = Channel 3 (AN3)
 0100 = Channel 4 (AN4)
 0101 = Channel 5 (AN5)^(1,2)
 0110 = Channel 6 (AN6)^(1,2)
 0111 = Channel 7 (AN7)^(1,2)
 1000 = Channel 8 (AN8)
 1001 = Channel 9 (AN9)
 1010 = Channel 10 (AN10)
 1011 = Channel 11 (AN11)
 1100 = Channel 12 (AN12)
 1101 = Unimplemented⁽²⁾
 1110 = Unimplemented⁽²⁾
 1111 = Unimplemented⁽²⁾

bit 1 **GO/DONE:** A/D Conversion Status bit

When ADON = 1:

1 = A/D conversion in progress
 0 = A/D Idle

bit 0 **ADON:** A/D On bit

1 = A/D Converter module is enabled
 0 = A/D Converter module is disabled

Note 1: These channels are not implemented on PIC18F2423/2523 devices.

2: Performing a conversion on unimplemented channels will return a floating input measurement.

PIC18F2423/2523/4423/4523

REGISTER 2-2: ADCON1: A/D CONTROL REGISTER 1

U-0	U-0	R/W-0	R/W-0	R/W-0 ⁽¹⁾	R/W ⁽¹⁾	R/W ⁽¹⁾	R/W ⁽¹⁾
—	—	VCFG1	VCFG0	PCFG3	PCFG2	PCFG1	PCFG0
bit 7							bit 0

Legend:

R = Readable bit

W = Writable bit

U = Unimplemented bit, read as '0'

-n = Value at POR

'1' = Bit is set

'0' = Bit is cleared

x = Bit is unknown

bit 7-6 **Unimplemented:** Read as '0'

bit 5 **VCFG1:** Voltage Reference Configuration bit (VREF- source)

1 = VREF- (AN2)

0 = VSS

bit 4 **VCFG0:** Voltage Reference Configuration bit (VREF+ source)

1 = VREF+ (AN3)

0 = VDD

bit 3-0 **PCFG<3:0>:** A/D Port Configuration Control bits:

PCFG<3:0>	AN12	AN11	AN10	AN9	AN8	AN7 ⁽²⁾	AN6 ⁽²⁾	AN5 ⁽²⁾	AN4	AN3	AN2	AN1	AN0
0000 ⁽¹⁾	A	A	A	A	A	A	A	A	A	A	A	A	A
0001	A	A	A	A	A	A	A	A	A	A	A	A	A
0010	A	A	A	A	A	A	A	A	A	A	A	A	A
0011	D	A	A	A	A	A	A	A	A	A	A	A	A
0100	D	D	A	A	A	A	A	A	A	A	A	A	A
0101	D	D	D	A	A	A	A	A	A	A	A	A	A
0110	D	D	D	D	A	A	A	A	A	A	A	A	A
0111 ⁽¹⁾	D	D	D	D	D	A	A	A	A	A	A	A	A
1000	D	D	D	D	D	D	A	A	A	A	A	A	A
1001	D	D	D	D	D	D	D	A	A	A	A	A	A
1010	D	D	D	D	D	D	D	D	A	A	A	A	A
1011	D	D	D	D	D	D	D	D	D	A	A	A	A
1100	D	D	D	D	D	D	D	D	D	D	A	A	A
1101	D	D	D	D	D	D	D	D	D	D	D	A	A
1110	D	D	D	D	D	D	D	D	D	D	D	D	A
1111	D	D	D	D	D	D	D	D	D	D	D	D	D

A = Analog input

D = Digital I/O

Note 1: The POR value of the PCFG bits depends on the value of the PBADEN Configuration bit. When PBADEN = 1, PCFG<3:0> = 0000; when PBADEN = 0, PCFG<3:0> = 0111.

2: AN5 through AN7 are only available on PIC18F4423/4523 devices.

PIC18F2423/2523/4423/4523

REGISTER 2-3: ADCON2: A/D CONTROL REGISTER 2

R/W-0	U-0	R/W-0	R/W-0	R/W-0	R/W-0	R/W-0	R/W-0
ADFM	—	ACQT2	ACQT1	ACQT0	ADCS2	ADCS1	ADCS0
bit 7							bit 0

Legend:

R = Readable bit W = Writable bit U = Unimplemented bit, read as '0'
 -n = Value at POR '1' = Bit is set '0' = Bit is cleared x = Bit is unknown

- bit 7 **ADFM:** A/D Result Format Select bit
 1 = Right justified
 0 = Left justified
- bit 6 **Unimplemented:** Read as '0'
- bit 5-3 **ACQT<2:0>:** A/D Acquisition Time Select bits
 111 = 20 TAD
 110 = 16 TAD
 101 = 12 TAD
 100 = 8 TAD
 011 = 6 TAD
 010 = 4 TAD
 001 = 2 TAD
 000 = 0 TAD⁽¹⁾
- bit 2-0 **ADCS<2:0>:** A/D Conversion Clock Select bits
 111 = FRC (clock derived from A/D RC oscillator)⁽¹⁾
 110 = FOSC/64
 101 = FOSC/16
 100 = FOSC/4
 011 = FRC (clock derived from A/D RC oscillator)⁽¹⁾
 010 = FOSC/32
 001 = FOSC/8
 000 = FOSC/2

Note 1: If the A/D FRC clock source is selected, a delay of one T_{CY} (instruction cycle) is added before the A/D clock starts. This allows the *SLEEP* instruction to be executed before starting a conversion.

PIC18F2423/2523/4423/4523

The analog reference voltage is software selectable to either the device's positive and negative supply voltage (VDD and VSS), or the voltage level on the RA3/AN3/VREF+ and RA2/AN2/VREF-/CVREF pins.

The A/D Converter has a unique feature of being able to operate while the device is in Sleep mode. To operate in Sleep, the A/D conversion clock must be derived from the A/D's internal RC oscillator.

The output of the sample and hold is the input into the converter, which generates the result via successive approximation.

A device Reset forces all registers to their Reset state. This forces the A/D module to be turned off and any conversion in progress is aborted.

Each port pin associated with the A/D Converter can be configured as an analog input or as a digital I/O. The ADRESH and ADRESL registers contain the result of the A/D conversion. When the A/D conversion is complete, the result is loaded into the ADRESH:ADRESL register pair, the GO/DONE bit (ADCON0<1>) is cleared and A/D Interrupt Flag bit, ADIF, is set.

The block diagram of the A/D module is shown in Figure 2-1.

FIGURE 2-1: A/D BLOCK DIAGRAM



PIC18F2423/2523/4423/4523

The value in the ADRESH:ADRESL registers is unknown following POR and BOR Resets and is not affected by any other Reset.

After the A/D module has been configured as desired, the selected channel must be acquired before the conversion is started. The analog input channels must have their corresponding TRIS bits selected as inputs. To determine acquisition time, see **Section 2.1 “A/D Acquisition Requirements”**.

After this acquisition time has elapsed, the A/D conversion can be started. An acquisition time can be programmed to occur between setting the GO/DONE bit and the actual start of the conversion.

The following steps should be followed to perform an A/D conversion:

1. Configure the A/D module:
 - Configure analog pins, voltage reference and digital I/O (ADCON1)
 - Select A/D input channel (ADCON0)
 - Select A/D acquisition time (ADCON2)
 - Select A/D conversion clock (ADCON2)
 - Turn on the A/D module (ADCON0)
2. Configure the A/D interrupt (if desired):
 - Clear ADIF bit
 - Set ADIE bit
 - Set GIE bit
3. Wait the required acquisition time (if required).
4. Start conversion by setting the GO/DONE bit (ADCON0<1>).

5. Wait for the A/D conversion to complete by either:
 - Polling for the GO/DONE bit to be cleared
 OR
 - Waiting for the A/D interrupt
6. Read the A/D Result registers (ADRESH:ADRESL) and clear the ADIF bit, if required.
7. For the next conversion, go to step 1 or step 2, as required.

The A/D conversion time per bit is defined as TAD. A minimum wait of 2 TAD is required before the next acquisition starts.

FIGURE 2-2: A/D TRANSFER FUNCTION

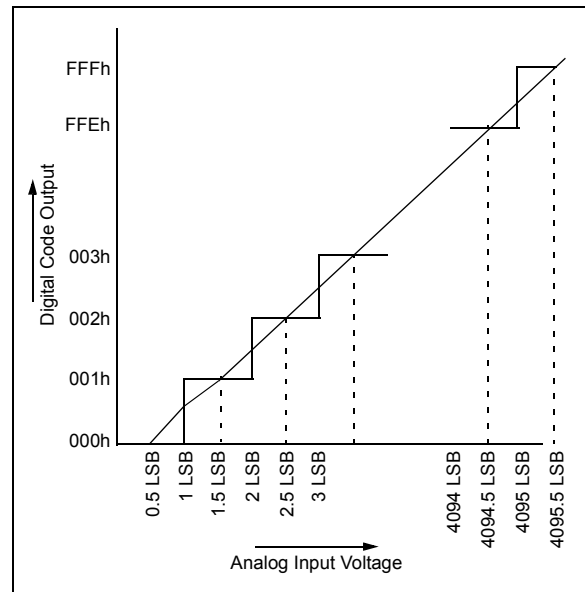

FIGURE 2-3: ANALOG INPUT MODEL



PIC18F2423/2523/4423/4523

2.1 A/D Acquisition Requirements

For the A/D Converter to meet its specified accuracy, the charge holding capacitor (CHOLD) must be allowed to fully charge to the input channel voltage level. The analog input model is shown in Figure 2-3.

The source impedance (Rs) and the internal sampling switch (Rss) impedance directly affect the time required to charge the capacitor, CHOLD. The sampling switch (Rss) impedance varies over the device voltage (VDD). The source impedance affects the offset voltage at the analog input (due to pin leakage current). **The maximum recommended impedance for analog sources is 2.5 kΩ.**

After the analog input channel is selected (changed), the channel must be sampled for at least the minimum acquisition time before starting a conversion.

Note: When the conversion is started, the holding capacitor is disconnected from the input pin.

To calculate the minimum acquisition time, Equation 2-1 may be used. This equation assumes that 1/2 LSB error is used (4,096 steps for the A/D). The 1/2 LSB error is the maximum error allowed for the A/D to meet its specified resolution.

Example 2-3 shows the calculation of the minimum required acquisition time, TACQ. This calculation is based on the application system assumptions shown in Table 2-1:

TABLE 2-1: TACQ ASSUMPTIONS

CHOLD	=	25 pF
Rs	=	2.5 kΩ
Conversion Error	≤	1/2 LSB
VDD	=	3V → Rss = 4 kΩ
Temperature	=	85°C (system maximum)

EQUATION 2-1: ACQUISITION TIME

$$\begin{aligned} \text{TACQ} &= \text{Amplifier Settling Time} + \text{Holding Capacitor Charging Time} + \text{Temperature Coefficient} \\ &= \text{TAMP} + \text{TC} + \text{TCOFF} \end{aligned}$$

EQUATION 2-2: A/D MINIMUM CHARGING TIME

$$\begin{aligned} \text{V}_{\text{HOLD}} &= (\text{V}_{\text{REF}} - (\text{V}_{\text{REF}}/4096)) \cdot (1 - e^{-(\text{TC}/\text{CHOLD})(\text{RIC} + \text{RSS} + \text{RS})}) \\ \text{or} \\ \text{TC} &= -(\text{CHOLD})(\text{RIC} + \text{RSS} + \text{RS}) \ln(1/4096) \end{aligned}$$

EQUATION 2-3: CALCULATING THE MINIMUM REQUIRED ACQUISITION TIME

$$\begin{aligned} \text{TACQ} &= \text{TAMP} + \text{TC} + \text{TCOFF} \\ \text{TAMP} &= 0.2 \mu\text{s} \\ \text{TCOFF} &= (\text{Temp} - 25^\circ\text{C})(0.02 \mu\text{s}/^\circ\text{C}) \\ &\quad (85^\circ\text{C} - 25^\circ\text{C})(0.02 \mu\text{s}/^\circ\text{C}) \\ &\quad 1.2 \mu\text{s} \end{aligned}$$

Temperature coefficient is only required for temperatures > 25°C. Below 25°C, TCOFF = 0 ms.

$$\begin{aligned} \text{TC} &= -(\text{CHOLD})(\text{RIC} + \text{RSS} + \text{RS}) \ln(1/4096) \mu\text{s} \\ &\quad -(25 \text{ pF})(1 \text{ k}\Omega + 4 \text{ k}\Omega + 2.5 \text{ k}\Omega) \ln(0.0004883) \mu\text{s} \\ &\quad 1.56 \mu\text{s} \end{aligned}$$

$$\begin{aligned} \text{TACQ} &= 0.2 \mu\text{s} + 1.56 \mu\text{s} + 1.2 \mu\text{s} \\ &\quad 2.96 \mu\text{s} \end{aligned}$$

2.2 Selecting and Configuring Acquisition Time

The ADCON2 register allows the user to select an acquisition time that occurs each time the GO/DONE bit is set. It also gives users the option of having an automatically determined acquisition time.

Acquisition time may be set with the ACQT<2:0> bits (ADCON2<5:3>), which provide a range of 2 to 20 TAD. When the GO/DONE bit is set, the A/D module continues to sample the input for the selected acquisition time, then automatically begins a conversion. Since the acquisition time is programmed, there may be no need to wait for an acquisition time between selecting a channel and setting the GO/DONE bit.

Manual acquisition time is selected when ACQT<2:0> = 000. When the GO/DONE bit is set, sampling is stopped and a conversion begins. The user is responsible for ensuring the required acquisition time has passed between selecting the desired input channel and setting the GO/DONE bit. This option is also the default Reset state of the ACQT<2:0> bits and is compatible with devices that do not offer programmable acquisition times.

In either case, when the conversion is completed, the GO/DONE bit is cleared, the ADIF flag is set and the A/D begins sampling the currently selected channel again. If an acquisition time is programmed, there is nothing to indicate if the acquisition time has ended or if the conversion has begun.

2.3 Selecting the A/D Conversion Clock

The A/D conversion time per bit is defined as TAD. The A/D conversion requires 13 TAD per 12-bit conversion. The source of the A/D conversion clock is software selectable.

There are seven possible options for TAD:

- 2 TOSC
- 4 TOSC
- 8 TOSC
- 16 TOSC
- 32 TOSC
- 64 TOSC
- Internal RC Oscillator

For correct A/D conversions, the A/D conversion clock (TAD) must be as short as possible, but greater than the minimum TAD. (For more information, see parameter 130 on page 41.)

Table 2-2 shows the resultant TAD times derived from the device operating frequencies and the A/D clock source selected.

TABLE 2-2: TAD vs. DEVICE OPERATING FREQUENCIES

A/D Clock Source (TAD)		Assumes TAD Min. = 0.8 μ s
Operation	ADCS<2:0>	Maximum Fosc
2 TOSC	000	2.50 MHz
4 TOSC	100	5.00 MHz
8 TOSC	001	10.00 MHz
16 TOSC	101	20.00 MHz
32 TOSC	010	40.00 MHz
64 TOSC	110	40.00 MHz
RC ⁽²⁾	x11	1.00 MHz ⁽¹⁾

Note 1: The RC source has a typical TAD time of 2.5 μ s.

2: For device frequencies above 1 MHz, the device must be in Sleep for the entire conversion or a Fosc divider should be used instead; otherwise, the A/D accuracy specification may not be met.

PIC18F2423/2523/4423/4523

2.4 Operation in Power-Managed Modes

The selection of the automatic acquisition time and A/D conversion clock is determined in part by the clock source and frequency while in a power-managed mode.

If the A/D is expected to operate while the device is in a power-managed mode, the ADCS<2:0> bits in ADCON2 should be updated in accordance with the clock source to be used. The ACQT<2:0> bits do not need to be adjusted as the ADCS<2:0> bits adjust the TAD time for the new clock speed. After entering the mode, an A/D acquisition or conversion may be started. Once started, the device should continue to be clocked by the same clock source until the conversion has been completed.

If desired, the device may be placed into the corresponding Idle mode during the conversion. If the device clock frequency is less than 1 MHz, the A/D RC clock source should be selected.

Operation in Sleep mode requires the A/D FRC clock to be selected. If bits, ACQT<2:0>, are set to '000' and a conversion is started, the conversion will be delayed one instruction cycle to allow execution of the SLEEP instruction and entry to Sleep mode. The IDLEN bit (OSCCON<7>) must have already been cleared prior to starting the conversion.

2.5 Configuring Analog Port Pins

The ADCON1, TRISA, TRISB and TRISE registers all configure the A/D port pins. The port pins needed as analog inputs must have their corresponding TRIS bits set (input). If the TRIS bit is cleared (output), the digital output level (VOH or VOL) will be converted.

The A/D operation is independent of the state of the CHS<3:0> bits and the TRIS bits.

- | |
|---|
| <p>Note 1: When reading the PORT register, all pins configured as analog input channels will read as cleared (a low level). Analog conversion on pins configured as digital pins can be performed. The voltage on the pin will be accurately converted.</p> <p>2: Analog levels on any pin defined as a digital input may cause the digital input buffer to consume current out of the device's specification limits.</p> <p>3: The PBDEN bit in Configuration Register 3H configures PORTB pins to reset as analog or digital pins by controlling how the PCFG<3:0> bits in ADCON1 are reset.</p> |
|---|

2.6 A/D Conversions

Figure 2-4 shows the operation of the A/D Converter after the $\overline{\text{GO/DONE}}$ bit has been set and the $\text{ACQT}<2:0>$ bits are cleared. A conversion is started after the following instruction to allow entry into Sleep mode before the conversion begins.

Figure 2-5 shows the operation of the A/D Converter after the $\overline{\text{GO/DONE}}$ bit has been set, the $\text{ACQT}<2:0>$ bits have been set to '010' and a 4 TAD acquisition time has been selected before the conversion starts.

Clearing the $\overline{\text{GO/DONE}}$ bit during a conversion will abort the current conversion. The A/D Result register pair will NOT be updated with the partially completed A/D conversion sample. This means, the ADRESH:ADRESL registers will continue to contain the value of the last completed conversion (or the last value written to the ADRESH:ADRESL registers).

After the A/D conversion is completed or aborted, a 2TCY wait is required before the next acquisition can be started. After this wait, acquisition on the selected channel is automatically started.

Note: The $\overline{\text{GO/DONE}}$ bit should **NOT** be set in the same instruction that turns on the A/D. Code should wait at least 3 TAD after enabling the A/D before beginning an acquisition and conversion cycle.

2.7 Discharge

The discharge phase is used to initialize the value of the holding capacitor. The array is discharged before every sample. This feature helps to optimize the unity-gain amplifier, as the circuit always needs to charge the capacitor array, rather than charge/discharge based on previous measure values.

FIGURE 2-4: A/D CONVERSION TAD CYCLES ($\text{ACQT}<2:0> = 000, \text{TACQ} = 0$)



FIGURE 2-5: A/D CONVERSION TAD CYCLES ($\text{ACQT}<2:0> = 010, \text{TACQ} = 4\text{ TAD}$)



PIC18F2423/2523/4423/4523

2.8 Use of the CCP2 Trigger

An A/D conversion can be started by the Special Event Trigger of the CCP2 module. This requires that the CCP2M<3:0> bits (CCP2CON<3:0>) be programmed as '1011' and that the A/D module is enabled (ADON bit is set). When the trigger occurs, the GO/DONE bit will be set, starting the A/D acquisition and conversion, and the Timer1 (or Timer3) counter will be reset to zero. Timer1 (or Timer3) is reset to automatically repeat the A/D acquisition period with minimal software overhead (moving ADRESH:ADRESL to the desired location).

The appropriate analog input channel must be selected and the minimum acquisition period is either timed by the user or an appropriate TACQ time is selected before the Special Event Trigger sets the GO/DONE bit (starts a conversion).

If the A/D module is not enabled (ADON is cleared), the Special Event Trigger will be ignored by the A/D module, but will still reset the Timer1 (or Timer3) counter.

TABLE 2-3: REGISTERS ASSOCIATED WITH A/D OPERATION

Name	Bit 7	Bit 6	Bit 5	Bit 4	Bit 3	Bit 2	Bit 1	Bit 0	Reset Values on page
INTCON	GIE/GIEH	PEIE/GIEL	TMR0IE	INT0IE	RBIE	TMR0IF	INT0IF	RBFIF	(Note 4)
PIR1	PSPIF ⁽¹⁾	ADIF	RCIF	TXIF	SSPIF	CCP1IF	TMR2IF	TMR1IF	(Note 4)
PIE1	PSPIE ⁽¹⁾	ADIE	RCIE	TXIE	SSPIE	CCP1IE	TMR2IE	TMR1IE	(Note 4)
IPR1	PSPPIP ⁽¹⁾	ADIP	RCIP	TXIP	SSPIP	CCP1IP	TMR2IP	TMR1IP	(Note 4)
PIR2	OSCFIF	CMIF	—	EEIF	BCLIF	HLVDIF	TMR3IF	CCP2IF	(Note 4)
PIE2	OSCFIE	CMIE	—	EEIE	BCLIE	HLVDIE	TMR3IE	CCP2IE	(Note 4)
IPR2	OSCFIP	CMIP	—	EEIP	BCLIP	HLVDIP	TMR3IP	CCP2IP	(Note 4)
ADRESH	A/D Result Register High Byte								(Note 4)
ADRESL	A/D Result Register Low Byte								(Note 4)
ADCON0	—	—	CHS3	CHS2	CHS1	CHS0	GO/DONE	ADON	(Note 4)
ADCON1	—	—	VCFG1	VCFG0	PCFG3	PCFG2	PCFG1	PCFG0	(Note 4)
ADCON2	ADFM	—	ACQT2	ACQT1	ACQT0	ADCS2	ADCS1	ADCS0	(Note 4)
PORTA	RA7 ⁽²⁾	RA6 ⁽²⁾	RA5	RA4	RA3	RA2	RA1	RA0	(Note 4)
TRISA	TRISA7 ⁽²⁾	TRISA6 ⁽²⁾	PORTA Data Direction Control Register						(Note 4)
PORTB	RB7	RB6	RB5	RB4	RB3	RB2	RB1	RB0	(Note 4)
TRISB	PORTB Data Direction Control Register								(Note 4)
LATB	PORTB Data Latch Register (Read and Write to Data Latch)								(Note 4)
PORTE ⁽¹⁾	—	—	—	—	RE3 ⁽³⁾	RE2	RE1	RE0	(Note 4)
TRISE ⁽¹⁾	IBF	OBF	IBOV	PSPMODE	—	TRISE2	TRISE1	TRISE0	(Note 4)
LATE ⁽¹⁾	—	—	—	—	—	PORTE Data Latch Register			(Note 4)

Legend: — = unimplemented, read as '0'. Shaded cells are not used for A/D conversion.

- Note 1:** These registers and/or bits are not implemented on PIC18F2423/2523 devices and are read as '0'.
- 2:** PORTA<7:6> and their direction bits are individually configured as port pins based on various primary oscillator modes. When disabled, these bits read as '0'.
- 3:** RE3 port bit is available only as an input pin when the MCLRE Configuration bit is '0'.
- 4:** For these Reset values, see **Section 4.0 "Reset"** of the "PIC18F2420/2520/4420/4520 Data Sheet" (DS39631).

PIC18F2423/2523/4423/4523

3.0 SPECIAL FEATURES OF THE CPU

Note: For additional details on the Configuration bits, refer to **Section 23.1 “Configuration Bits”** in the “PIC18F2420/2520/4420/4520 Data Sheet” (DS39631). Device ID information presented in this section is for the PIC18F2423/2523/4423/4523 devices only.

3.1 Device ID Registers

The Device ID registers are read-only registers. They identify the device type and revision for device programmers and can be read by firmware using table reads.

TABLE 3-1: DEVICE IDs

File Name	Bit 7	Bit 6	Bit 5	Bit 4	Bit 3	Bit 2	Bit 1	Bit 0	Default/ Unprogrammed Value	
3FFFFEh	DEVID1 ⁽¹⁾	DEV3	DEV2	DEV1	DEV0	REV3	REV2	REV1	REV0	xxxx xxxx ⁽²⁾
3FFFFFh	DEVID2 ⁽¹⁾	DEV11	DEV10	DEV9	DEV8	DEV7	DEV6	DEV5	DEV4	xxxx xxxx ⁽²⁾

Legend: x = unknown, u = unchanged, — = unimplemented. Shaded cells are unimplemented, read as '0'.

Note 1: DEVID registers are read-only and cannot be programmed by the user.

2: See Register 3-1 and Register 3-2 for DEVID1 and DEVID2 values.

REGISTER 3-1: DEVID1: DEVICE ID REGISTER 1 FOR PIC18F2423/2523/4423/4523

R	R	R	R	R	R	R	R	
DEV3	DEV2	DEV1	DEV0	REV3	REV2	REV1	REV0	
bit 7							bit 0	

Legend:

R = Read-only bit

P = Programmable bit

U = Unimplemented bit, read as '0'

-n = Value when device is unprogrammed

u = Unchanged from programmed state

bit 7-4 **DEV<3:0>**: Device ID bits

1101 = PIC18F4423

1001 = PIC18F4523

0101 = PIC18F2423

0001 = PIC18F2523

bit 3-0 **REV<3:0>**: Revision ID bits

These bits are used to indicate the device revision.

PIC18F2423/2523/4423/4523

REGISTER 3-2: DEVID2: DEVICE ID REGISTER 2 FOR PIC18F2423/2523/4423/4523

R	R	R	R	R	R	R	R
DEV11 ⁽¹⁾	DEV10 ⁽¹⁾	DEV9 ⁽¹⁾	DEV8 ⁽¹⁾	DEV7 ⁽¹⁾	DEV6 ⁽¹⁾	DEV5 ⁽¹⁾	DEV4 ⁽¹⁾
bit 7							bit 0

Legend:

R = Read-only bit

P = Programmable bit

U = Unimplemented bit, read as '0'

-n = Value when device is unprogrammed

u = Unchanged from programmed state

bit 7-0 **DEV<11:4>**: Device ID bits⁽¹⁾

These bits are used with the DEV<3:0> bits in Device ID Register 1 to identify the part number.

0001 0001 = PIC18F2423/2523 devices

0001 0000 = PIC18F4423/4523 devices

Note 1: These values for DEV<11:4> may be shared with other devices. The specific device is always identified by using the entire DEV<11:0> bit sequence.

PIC18F2423/2523/4423/4523

4.0 ELECTRICAL CHARACTERISTICS

Note: Other than some basic data, this section documents only the PIC18F2423/2523/4423/4523 devices' specifications that differ from those of the PIC18F2420/2520/4420/4520 devices. For detailed information on the electrical specifications shared by the PIC18F2423/2523/4423/4523 and PIC18F2420/2520/4420/4520 devices, see the "PIC18F2420/2520/4420/4520 Data Sheet" (DS39631).

Absolute Maximum Ratings^(†)

Ambient temperature under bias	-40°C to +125°C
Storage temperature	-65°C to +150°C
Voltage on any pin with respect to V _{SS} (except V _{DD} and $\overline{\text{MCLR}}$)	-0.3V to (V _{DD} + 0.3V)
Voltage on V _{DD} with respect to V _{SS}	-0.3V to +7.5V
Voltage on $\overline{\text{MCLR}}$ with respect to V _{SS} (Note 2)	0V to +13.25V
Total power dissipation (Note 1)	1.0W
Maximum current out of V _{SS} pin	300 mA
Maximum current into V _{DD} pin	250 mA
Input clamp current, I _{IK} (V _I < 0 or V _I > V _{DD})	±20 mA
Output clamp current, I _{OK} (V _O < 0 or V _O > V _{DD})	±20 mA
Maximum output current sunk by any I/O pin	25 mA
Maximum output current sourced by any I/O pin	25 mA
Maximum current sunk by all ports	200 mA
Maximum current sourced by all ports	200 mA

Note 1: Power dissipation is calculated as follows:

$$P_{dis} = V_{DD} \times \{I_{DD} - \sum I_{OH}\} + \sum \{(V_{DD} - V_{OH}) \times I_{OH}\} + \sum (V_{OL} \times I_{OL})$$

2: Voltage spikes below V_{SS} at the $\overline{\text{MCLR}}$ /V_{PP}/RE3 pin, inducing currents greater than 80 mA, may cause latch-up. Thus, a series resistor of 50-100Ω should be used when applying a "low" level to the $\overline{\text{MCLR}}$ /V_{PP}/RE3 pin, rather than pulling this pin directly to V_{SS}.

† **NOTICE:** Stresses above those listed under "Absolute Maximum Ratings" may cause permanent damage to the device. This is a stress rating only and functional operation of the device at those or any other conditions above those indicated in the operation listings of this specification is not implied. Exposure to maximum rating conditions for extended periods may affect device reliability.

PIC18F2423/2523/4423/4523

FIGURE 4-1: PIC18F2423/2523/4423/4523 VOLTAGE-FREQUENCY GRAPH (INDUSTRIAL)

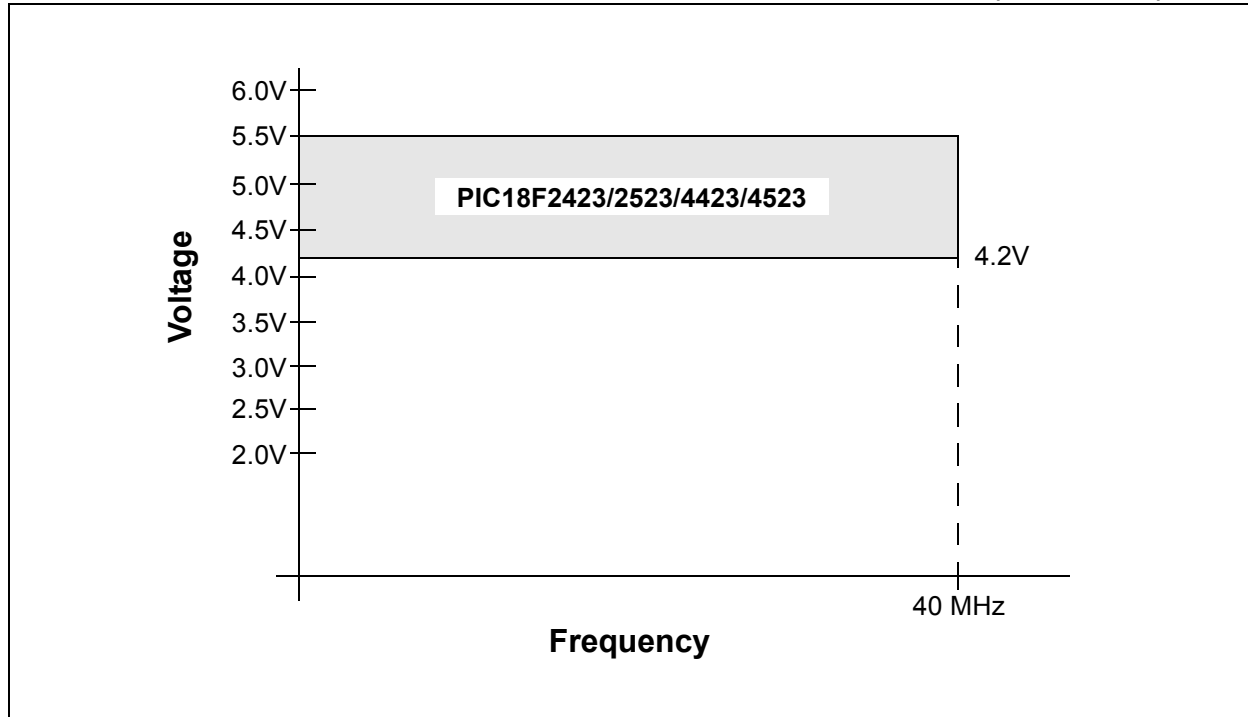
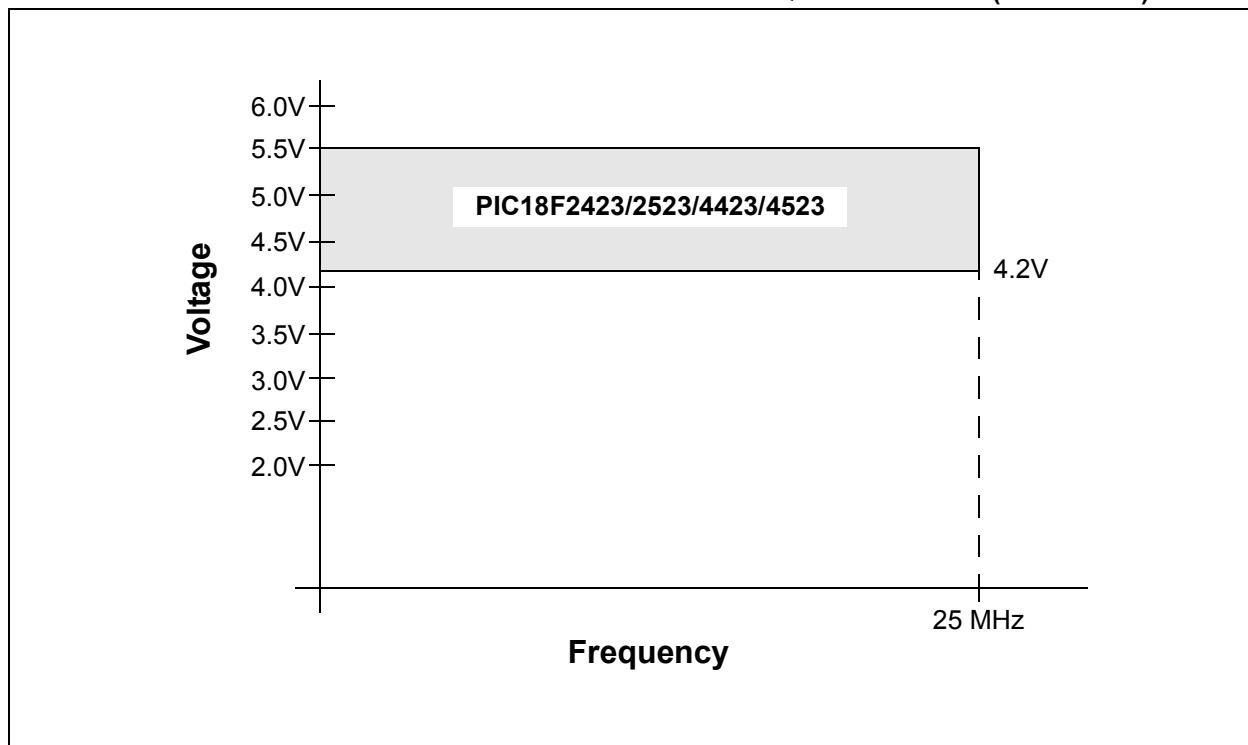
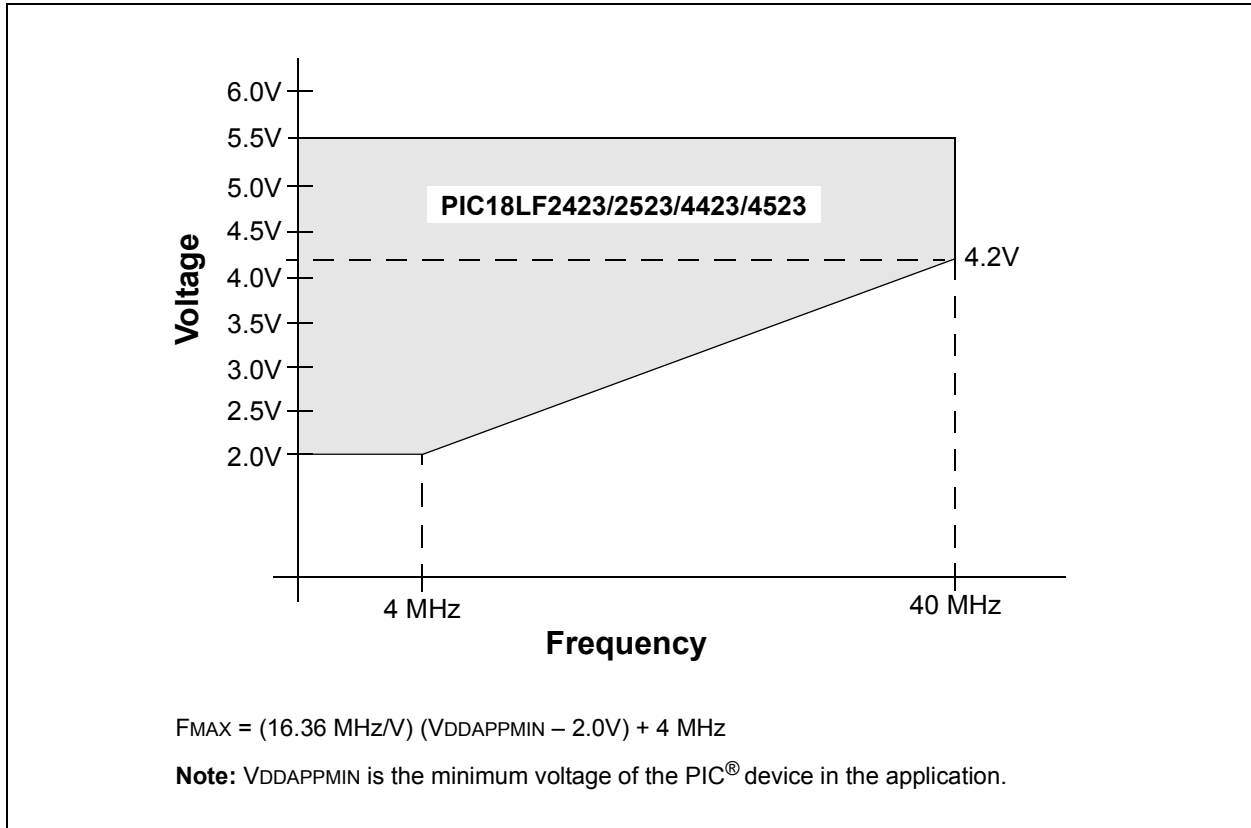

FIGURE 4-2: PIC18F2423/2523/4423/4523 VOLTAGE-FREQUENCY GRAPH (EXTENDED)



PIC18F2423/2523/4423/4523

FIGURE 4-3: PIC18LF2423/2523/4423/4523 VOLTAGE-FREQUENCY GRAPH (INDUSTRIAL)



PIC18F2423/2523/4423/4523

**TABLE 4-1: A/D CONVERTER CHARACTERISTICS: PIC18F2423/2523/4423/4523 (INDUSTRIAL)
PIC18LF2423/2523/4423/4523 (INDUSTRIAL)**

Param No.	Sym	Characteristic	Min	Typ	Max	Units	Conditions	
A01	NR	Resolution	—	—	12	bit		$\Delta V_{REF} \geq 3.0V$
A03	EIL	Integral Linearity Error	—	$<\pm 1$	± 2.0	LSB	$V_{DD} = 3.0V$	$\Delta V_{REF} \geq 3.0V$
			—	—	± 2.0	LSB	$V_{DD} = 5.0V$	
A04	EDL	Differential Linearity Error	—	$<\pm 1$	+1.5/-1.0	LSB	$V_{DD} = 3.0V$	$\Delta V_{REF} \geq 3.0V$
			—	—	+1.5/-1.0	LSB	$V_{DD} = 5.0V$	
A06	EOFF	Offset Error	—	$<\pm 1$	± 5	LSB	$V_{DD} = 3.0V$	$\Delta V_{REF} \geq 3.0V$
			—	—	± 3	LSB	$V_{DD} = 5.0V$	
A07	EGN	Gain Error	—	$<\pm 1$	± 1.25	LSB	$V_{DD} = 3.0V$	$\Delta V_{REF} \geq 3.0V$
			—	—	± 2.00	LSB	$V_{DD} = 5.0V$	
A10	—	Monotonicity	Guaranteed ⁽¹⁾			—		$V_{SS} \leq V_{AIN} \leq V_{REF}$
A20	ΔV_{REF}	Reference Voltage Range ($V_{REFH} - V_{REFL}$)	3	—	$V_{DD} - V_{SS}$	V		For 12-bit resolution.
A21	V_{REFH}	Reference Voltage High	$V_{SS} + 3.0V$	—	$V_{DD} + 0.3V$	V		For 12-bit resolution.
A22	V_{REFL}	Reference Voltage Low	$V_{SS} - 0.3V$	—	$V_{DD} - 3.0V$	V		For 12-bit resolution.
A25	V_{AIN}	Analog Input Voltage	V_{REFL}	—	V_{REFH}	V		
A30	Z_{AIN}	Recommended Impedance of Analog Voltage Source	—	—	2.5	k Ω		
A50	I _{REF}	V_{REF} Input Current ⁽²⁾	—	—	5	μA		During V_{AIN} acquisition. During A/D conversion cycle.
			—	—	150	μA		

- Note 1:** The A/D conversion result never decreases with an increase in the input voltage and has no missing codes.
Note 2: V_{REFH} current is from the RA3/AN3/ V_{REF+} pin or V_{DD} , whichever is selected as the V_{REFH} source. V_{REFL} current is from the RA2/AN2/ V_{REF-}/CV_{REF} pin or V_{SS} , whichever is selected as the V_{REFL} source.

PIC18F2423/2523/4423/4523

FIGURE 4-4: A/D CONVERSION TIMING



TABLE 4-2: A/D CONVERSION REQUIREMENTS

Param No.	Symbol	Characteristic	Min	Max	Units	Conditions	
130	TAD	A/D Clock Period	PIC18FXXXX	0.8	12.5 ⁽¹⁾	μs	TOSC based, VREF ≥ 3.0V
			PIC18LFXXXX	1.4	25.0 ⁽¹⁾	μs	VDD = 3.0V; TOSC based, VREF full range
		PIC18FXXXX	—	1	μs	A/D RC mode	
		PIC18LFXXXX	—	3	μs	VDD = 3.0V; A/D RC mode	
131	Tcnv	Conversion Time (not including acquisition time) ⁽²⁾	13	14	TAD		
132	TAcq	Acquisition Time ⁽³⁾	1.4	—	μs		
135	Tswc	Switching Time from Convert → Sample	—	(Note 4)			
137	Tdis	Discharge Time	0.2	—	μs		

- Note 1:** The time of the A/D clock period is dependent on the device frequency and the TAD clock divider.
- Note 2:** ADRES registers may be read on the following Tcy cycle.
- Note 3:** The time for the holding capacitor to acquire the “New” input voltage when the voltage changes full scale after the conversion (VDD to VSS or VSS to VDD). The source impedance (Rs) on the input channels is 50Ω.
- Note 4:** On the following cycle of the device clock.

PIC18F2423/2523/4423/4523

NOTES:

5.0 PACKAGING INFORMATION

For packaging information, see **Section 28.0 “Packaging Information”** in the *“PIC18F2420/2520/4420/4520 Data Sheet”* (DS39631).

PIC18F2423/2523/4423/4523

NOTES:

PIC18F2423/2523/4423/4523

APPENDIX A: REVISION HISTORY

Revision A (June 2006)

Original data sheet for PIC18F2423/2523/4423/4523 devices.

Revision B (January 2007)

This revision includes updates to the packaging diagrams.

Revision C (September 2009)

Electrical specifications updated. Preliminary condition status removed. Converted document to the "mini data sheet" format.

APPENDIX B: DEVICE DIFFERENCES

The differences between the devices listed in this data sheet are shown in Table B-1.

TABLE B-1: DEVICE DIFFERENCES

Features	PIC18F2423	PIC18F2523	PIC18F4423	PIC18F4523
Program Memory (Bytes)	16384	32768	16384	32768
Program Memory (Instructions)	8192	16384	8192	16384
Interrupt Sources	19	19	20	20
I/O Ports	Ports A, B, C, (E)	Ports A, B, C, (E)	Ports A, B, C, D, E	Ports A, B, C, D, E
Capture/Compare/PWM Modules	2	2	1	1
Enhanced Capture/Compare/PWM Modules	0	0	1	1
Parallel Communications (PSP)	No	No	Yes	Yes
12-Bit Analog-to-Digital Module	10 Input Channels	10 Input Channels	13 Input Channels	13 Input Channels
Packages	28-Pin PDIP 28-Pin SOIC 28-Pin QFN	28-Pin PDIP 28-Pin SOIC 28-Pin QFN	40-Pin PDIP 44-Pin TQFP 44-Pin QFN	40-Pin PDIP 44-Pin TQFP 44-Pin QFN

PIC18F2423/2523/4423/4523

APPENDIX C: CONVERSION CONSIDERATIONS

This appendix discusses the considerations for converting from previous versions of a device to the ones listed in this data sheet. Typically, these changes are due to the differences in the process technology used. An example of this type of conversion is from a PIC16C74A to a PIC16C74B.

Not Applicable

APPENDIX D: MIGRATION FROM BASELINE TO ENHANCED DEVICES

This section discusses how to migrate from a Baseline device (i.e., PIC16C5X) to an Enhanced MCU device (i.e., PIC18FXXX).

The following are the list of modifications over the PIC16C5X microcontroller family:

Not Currently Available

APPENDIX E: MIGRATION FROM MID-RANGE TO ENHANCED DEVICES

A detailed discussion of the differences between the mid-range MCU devices (i.e., PIC16CXXX) and the enhanced devices (i.e., PIC18FXXX) is provided in AN716, "*Migrating Designs from PIC16C74A/74B to PIC18C442*". The changes discussed, while device specific, are generally applicable to all mid-range to enhanced device migrations.

This Application Note is available as Literature Number DS00716.

APPENDIX F: MIGRATION FROM HIGH-END TO ENHANCED DEVICES

A detailed discussion of the migration pathway and differences between the high-end MCU devices (i.e., PIC17CXXX) and the enhanced devices (i.e., PIC18FXXX) is provided in AN726, "*PIC17CXXX to PIC18CXXX Migration*". This Application Note is available as Literature Number DS00726.

PIC18F2423/2523/4423/4523

NOTES:

INDEX

A

A/D	25
A/D Converter Interrupt, Configuring	29
Acquisition Requirements	30
ADCON0 Register	25
ADCON1 Register	25
ADCON2 Register	25
ADRESH Register	25, 28
ADRESL Register	25
Analog Port Pins, Configuring	32
Associated Registers	34
Configuring the Module	29
Conversion Clock (TAD)	31
Conversion Status (GO/DONE Bit)	28
Conversions	33
Converter Characteristics	40
Discharge	33
Operation in Power-Managed Modes	32
Selecting and Configuring Acquisition Time	31
Special Event Trigger (CCP)	34
Use of the CCP2 Trigger	34
Absolute Maximum Ratings	37
ADCON0 Register	25
GO/DONE Bit	28
ADCON1 Register	25
ADCON2 Register	25
ADRESH Register	25
ADRESL Register	25, 28
Analog-to-Digital Converter. <i>See</i> A/D.	

B

Block Diagrams	
A/D	28
Analog Input Model	29
PIC18F2423/2523 (28-Pin)	12
PIC18F4423/4523 (40/44-Pin)	13

C

Compare (CCP Module)	
Special Event Trigger	34
Conversion Considerations	46
Customer Change Notification Service	51
Customer Notification Service	51
Customer Support	51

D

Device Differences	45
Device Overview	9
Details on Individual Family Members	10
Features (table)	11
New Core Features	9
Other Special Features	10
Documentation	
Related Data Sheet	9

E

Electrical Characteristics	37
Equations	
A/D Acquisition Time	30
A/D Minimum Charging Time	30
Calculating the Minimum Required Acquisition Time	30
Errata	8

I

Internet Address	51
Interrupt Sources	
A/D Conversion Complete	29

M

Microchip Internet Web Site	51
Migration from Baseline to Enhanced Devices	46
Migration from High-End to Enhanced Devices	47
Migration from Mid-Range to Enhanced Devices	47

P

Packaging Information	43
Pin Functions	
MCLR/VPP/RE3	14, 18
OSC1/CLKI/RA7	14, 18
OSC2/CLKO/RA6	14, 18
RA0/AN0	15, 19
RA1/AN1	15, 19
RA2/AN2/VREF-/CVREF	15, 19
RA3/AN3/VREF+	15, 19
RA4/T0CKI/C1OUT	15, 19
RA5/AN4/SS/HLVDIN/C2OUT	15, 19
RB0/INT0/FLT0/AN12	16, 20
RB1/INT1/AN10	16, 20
RB2/INT2/AN8	16, 20
RB3/AN9/CCP2	16, 20
RB4/KBI0/AN11	16, 20
RB5/KBI1/PGM	16, 20
RB6/KBI2/PGC	16, 20
RB7/KBI3/PGD	16, 20
RC0/T1OSO/T13CKI	17, 21
RC1/T1OSI/CCP2	17, 21
RC2/CCP1	17
RC2/CCP1/P1A	21
RC3/SCK/SCL	17, 21
RC4/SDI/SDA	17, 21
RC5/SDO	17, 21
RC6/TX/CK	17, 21
RC7/RX/DT	17, 21
RD0/PSP0	22
RD1/PSP1	22
RD2/PSP2	22
RD3/PSP3	22
RD4/PSP4	22
RD5/PSP5/P1B	22
RD6/PSP6/P1C	22
RD7/PSP7/P1D	22
RE0/RD/AN5	23
RE1/WR/AN6	23
RE2/CS/AN7	23
VDD	17, 23
VSS	17, 23
Pinout I/O Descriptions	
PIC18F2423/2523	14
PIC18F4423/4523	18
Power-Managed Modes	
and A/D Operation	32

PIC18F2423/2523/4423/4523

R

Reader Response	52
Registers	
ADCON0 (A/D Control 0)	25
ADCON1 (A/D Control 1)	26
ADCON2 (A/D Control 2)	27
DEVID1 (Device ID 1)	35
DEVID2 (Device ID 2)	36
Revision History	45

S

Special Features of the CPU	35
-----------------------------------	----

T

Timing Diagrams	
A/D Conversion	41
Timing Diagrams and Specifications	
A/D Conversion Requirements	41

V

Voltage-Frequency Graphics	
PIC18F2423/2523/4423/4523 (Extended)	38
PIC18F2423/2523/4423/4523 (Industrial)	38
PIC18LF2423/2523/4423/4523 (Industrial)	39

W

WWW Address	51
WWW, On-Line Support	8

THE MICROCHIP WEB SITE

Microchip provides online support via our WWW site at www.microchip.com. This web site is used as a means to make files and information easily available to customers. Accessible by using your favorite Internet browser, the web site contains the following information:

- **Product Support** – Data sheets and errata, application notes and sample programs, design resources, user's guides and hardware support documents, latest software releases and archived software
- **General Technical Support** – Frequently Asked Questions (FAQ), technical support requests, online discussion groups, Microchip consultant program member listing
- **Business of Microchip** – Product selector and ordering guides, latest Microchip press releases, listing of seminars and events, listings of Microchip sales offices, distributors and factory representatives

CUSTOMER CHANGE NOTIFICATION SERVICE

Microchip's customer notification service helps keep customers current on Microchip products. Subscribers will receive e-mail notification whenever there are changes, updates, revisions or errata related to a specified product family or development tool of interest.

To register, access the Microchip web site at www.microchip.com, click on Customer Change Notification and follow the registration instructions.

CUSTOMER SUPPORT

Users of Microchip products can receive assistance through several channels:

- Distributor or Representative
- Local Sales Office
- Field Application Engineer (FAE)
- Technical Support
- Development Systems Information Line

Customers should contact their distributor, representative or field application engineer (FAE) for support. Local sales offices are also available to help customers. A listing of sales offices and locations is included in the back of this document.

Technical support is available through the web site at: <http://support.microchip.com>

PIC18F2423/2523/4423/4523

READER RESPONSE

It is our intention to provide you with the best documentation possible to ensure successful use of your Microchip product. If you wish to provide your comments on organization, clarity, subject matter, and ways in which our documentation can better serve you, please FAX your comments to the Technical Publications Manager at (480) 792-4150.

Please list the following information, and use this outline to provide us with your comments about this document.

To: Technical Publications Manager
RE: Reader Response
Total Pages Sent _____

From: Name _____
Company _____
Address _____
City / State / ZIP / Country _____
Telephone: (_____) _____ - _____ FAX: (_____) _____ - _____

Application (optional):

Would you like a reply? ___Y ___N

Device: PIC18F2423/2523/4423/4523 Literature Number: DS39755C

Questions:

1. What are the best features of this document?

2. How does this document meet your hardware and software development needs?

3. Do you find the organization of this document easy to follow? If not, why?

4. What additions to the document do you think would enhance the structure and subject?

5. What deletions from the document could be made without affecting the overall usefulness?

6. Is there any incorrect or misleading information (what and where)?

7. How would you improve this document?

PIC18F2423/2523/4423/4523

PRODUCT IDENTIFICATION SYSTEM

To order or obtain information, e.g., on pricing or delivery, refer to the factory or the listed sales office.

<u>PART NO.</u>	<u>X</u>	<u>/XX</u>	<u>XXX</u>
Device	Temperature Range	Package	Pattern
Device	PIC18F2423 ⁽¹⁾ , PIC18F2523 ⁽¹⁾ , PIC18F4423T ⁽²⁾ , PIC18F4523T ⁽²⁾ ; VDD range 4.2V to 5.5V PIC18F2423 ⁽¹⁾ , PIC18F2523 ⁽¹⁾ , PIC18F4423T ⁽²⁾ , PIC18F4523T ⁽²⁾ ; VDD range 2.0V to 5.5V		
Temperature Range	I = -40°C to +85°C (Industrial) E = -40°C to +125°C (Extended)		
Package	PT = TQFP (Thin Quad Flat pack) ML = QFN SO = SOIC SP = Skinny Plastic DIP P = PDIP		
Pattern	QTP, SQTP, Code or Special Requirements (blank otherwise)		

Examples:

- a) PIC18F4523-I/P 301 = Industrial temp., PDIP package, Extended VDD limits, QTP pattern #301.
- b) PIC18F4523-I/PT = Industrial temp., TQFP package, Extended VDD limits.
- c) PIC18F4523-E/P = Extended temp., PDIP package, normal VDD limits.

Note 1: F = Standard Voltage Range
 LF = Wide Voltage Range
2: T = In tape and reel PLCC, and TQFP packages only.



WORLDWIDE SALES AND SERVICE

AMERICAS

Corporate Office
2355 West Chandler Blvd.
Chandler, AZ 85224-6199
Tel: 480-792-7200
Fax: 480-792-7277
Technical Support:
<http://support.microchip.com>
Web Address:
www.microchip.com

Atlanta
Duluth, GA
Tel: 678-957-9614
Fax: 678-957-1455

Boston
Westborough, MA
Tel: 774-760-0087
Fax: 774-760-0088

Chicago
Itasca, IL
Tel: 630-285-0071
Fax: 630-285-0075

Cleveland
Independence, OH
Tel: 216-447-0464
Fax: 216-447-0643

Dallas
Addison, TX
Tel: 972-818-7423
Fax: 972-818-2924

Detroit
Farmington Hills, MI
Tel: 248-538-2250
Fax: 248-538-2260

Kokomo
Kokomo, IN
Tel: 765-864-8360
Fax: 765-864-8387

Los Angeles
Mission Viejo, CA
Tel: 949-462-9523
Fax: 949-462-9608

Santa Clara
Santa Clara, CA
Tel: 408-961-6444
Fax: 408-961-6445

Toronto
Mississauga, Ontario,
Canada
Tel: 905-673-0699
Fax: 905-673-6509

ASIA/PACIFIC

Asia Pacific Office
Suites 3707-14, 37th Floor
Tower 6, The Gateway
Harbour City, Kowloon
Hong Kong
Tel: 852-2401-1200
Fax: 852-2401-3431

Australia - Sydney
Tel: 61-2-9868-6733
Fax: 61-2-9868-6755

China - Beijing
Tel: 86-10-8528-2100
Fax: 86-10-8528-2104

China - Chengdu
Tel: 86-28-8665-5511
Fax: 86-28-8665-7889

China - Hong Kong SAR
Tel: 852-2401-1200
Fax: 852-2401-3431

China - Nanjing
Tel: 86-25-8473-2460
Fax: 86-25-8473-2470

China - Qingdao
Tel: 86-532-8502-7355
Fax: 86-532-8502-7205

China - Shanghai
Tel: 86-21-5407-5533
Fax: 86-21-5407-5066

China - Shenyang
Tel: 86-24-2334-2829
Fax: 86-24-2334-2393

China - Shenzhen
Tel: 86-755-8203-2660
Fax: 86-755-8203-1760

China - Wuhan
Tel: 86-27-5980-5300
Fax: 86-27-5980-5118

China - Xiamen
Tel: 86-592-2388138
Fax: 86-592-2388130

China - Xian
Tel: 86-29-8833-7252
Fax: 86-29-8833-7256

China - Zhuhai
Tel: 86-756-3210040
Fax: 86-756-3210049

ASIA/PACIFIC

India - Bangalore
Tel: 91-80-3090-4444
Fax: 91-80-3090-4080

India - New Delhi
Tel: 91-11-4160-8631
Fax: 91-11-4160-8632

India - Pune
Tel: 91-20-2566-1512
Fax: 91-20-2566-1513

Japan - Yokohama
Tel: 81-45-471- 6166
Fax: 81-45-471-6122

Korea - Daegu
Tel: 82-53-744-4301
Fax: 82-53-744-4302

Korea - Seoul
Tel: 82-2-554-7200
Fax: 82-2-558-5932 or
82-2-558-5934

Malaysia - Kuala Lumpur
Tel: 60-3-6201-9857
Fax: 60-3-6201-9859

Malaysia - Penang
Tel: 60-4-227-8870
Fax: 60-4-227-4068

Philippines - Manila
Tel: 63-2-634-9065
Fax: 63-2-634-9069

Singapore
Tel: 65-6334-8870
Fax: 65-6334-8850

Taiwan - Hsin Chu
Tel: 886-3-6578-300
Fax: 886-3-6578-370

Taiwan - Kaohsiung
Tel: 886-7-536-4818
Fax: 886-7-536-4803

Taiwan - Taipei
Tel: 886-2-2500-6610
Fax: 886-2-2508-0102

Thailand - Bangkok
Tel: 66-2-694-1351
Fax: 66-2-694-1350

EUROPE

Austria - Wels
Tel: 43-7242-2244-39
Fax: 43-7242-2244-393

Denmark - Copenhagen
Tel: 45-4450-2828
Fax: 45-4485-2829

France - Paris
Tel: 33-1-69-53-63-20
Fax: 33-1-69-30-90-79

Germany - Munich
Tel: 49-89-627-144-0
Fax: 49-89-627-144-44

Italy - Milan
Tel: 39-0331-742611
Fax: 39-0331-466781

Netherlands - Drunen
Tel: 31-416-690399
Fax: 31-416-690340

Spain - Madrid
Tel: 34-91-708-08-90
Fax: 34-91-708-08-91

UK - Wokingham
Tel: 44-118-921-5869
Fax: 44-118-921-5820