

1-1718646-1 ✓ ACTIVE

MCON | MCON 1.2mm

TE Internal #: 1-1718646-1

Housing for Female Terminals, Wire-to-Wire, 6 Position, 4 mm [.157 in] Centerline, Sealable, Black, Wire & Cable, Power & Signal, MCON 1.2mm

[View on TE.com >](#)



Connectors > Automotive Connectors > Automotive Housings



Connector System: **Wire-to-Wire**

Number of Positions: **6**

Connector & Housing Type: **Housing for Female Terminals**

Centerline (Pitch): **4 mm [.157 in]**

Sealable: **Yes**

## Features

### Product Type Features

Mixed & Hybrid Connector	No
Connector Shape	Rectangular
Connector System	Wire-to-Wire
Connector & Housing Type	Housing for Female Terminals
Sealable	Yes
Connector & Contact Terminates To	Wire & Cable
Primary Locking Feature	On the Terminal

### Configuration Features

Number of Positions	6
Number of Rows	1

### Electrical Characteristics

Operating Voltage	12 VDC
Nominal Voltage Architecture	12 V, 24 V

### Body Features

Cable Exit Angle	180°
Primary Product Color	Black
Connector & Keying Code	A

### Contact Features



Contact Size	1.2mm
Contact Type	Receptacle
Mating Tab Width	1.2 mm[.047 in]
Contact Current Rating (Max)	15 A

### Mechanical Attachment

Terminal Position Assurance	Yes
Mating Alignment Type	Keyed
Mating Alignment	With
Connector Mounting Type	Cable Mount (Free-Hanging)

### Housing Features

Housing Material	PA GF
Centerline (Pitch)	4 mm[.157 in]

### Dimensions

Connector Height	16.5 mm[.65 in]
Product Width	26.5 mm[1.043 in]
Product Length	32.7 mm[1.287 in]

### Usage Conditions

Operating Temperature (Max)	130 °C[266 °F]
Operating Temperature Range	-40 – 130 °C[-40 – 266 °F]

### Operation/Application

Circuit Application	Power & Signal
---------------------	----------------

### Industry Standards

Degree of Protection	IP6K9K
----------------------	--------

### Packaging Features

Packaging Quantity	1500
Packaging Method	Box

### Other

Serviceable	Yes
Connector Position Assurance Capable	Yes

### Product Compliance

[For compliance documentation, visit the product page on TE.com>](#)









EU RoHS Directive 2011/65/EU	Compliant
EU ELV Directive 2000/53/EC	Compliant
China RoHS 2 Directive MIIT Order No 32, 2016	No Restricted Materials Above Threshold
EU REACH Regulation (EC) No. 1907/2006	Current ECHA Candidate List: JUNE 2024 (241) Candidate List Declared Against: JUNE 2024 (241) Does not contain REACH SVHC
Halogen Content	Low Halogen - Br, Cl, F, I < 900 ppm per homogenous material. Also BFR/CFR/PVC Free
Solder Process Capability	Not applicable for solder process capability

Product Compliance Disclaimer

This information is provided based on reasonable inquiry of our suppliers and represents our current actual knowledge based on the information they provided. This information is subject to change. The part numbers that TE has identified as EU RoHS compliant have a maximum concentration of 0.1% by weight in homogenous materials for lead, hexavalent chromium, mercury, PBB, PBDE, DBP, BBP, DEHP, DIBP, and 0.01% for cadmium, or qualify for an exemption to these limits as defined in the Annexes of Directive 2011/65/EU (RoHS2). Finished electrical and electronic equipment products will be CE marked as required by Directive 2011/65/EU. Components may not be CE marked. Additionally, the part numbers that TE has identified as EU ELV compliant have a maximum concentration of 0.1% by weight in homogenous materials for lead, hexavalent chromium, and mercury, and 0.01% for cadmium, or qualify for an exemption to these limits as defined in the Annexes of Directive 2000/53/EC (ELV). Regarding the REACH Regulation, the information TE provides on SVHC in articles for this part number is based on the latest European Chemicals Agency (ECHA) 'Guidance on requirements for substances in articles' posted at this URL: <https://echa.europa.eu/guidance-documents/guidance-on-reach>

## Compatible Parts

 <p>TE Part # 1-2141324-1 6POS, MCON 1.2 LL TAB SEALED COD A</p>	 <p>TE Part # CAT-N13-MSLRTT12 MCON 1.2 Locking Lance Receptacle and Tab Terminals</p>	 <p>TE Part # 2141970-1 MCON 1.2 LL REC SWS SN</p>	 <p>TE Part # 1801606-4 TAB HOUSING, MCON, 10 W, SEALED</p>
 <p>TE Part # 1-2141324-5 6POS, MCON 1.2 LL TAB SEALED COD A</p>	 <p>TE Part # 1801606-3 TAB HOUSING, MCON, 10 W, SEALED</p>	 <p>TE Part # 2295776-1 6POS, MCON1.2CB, RETAINER</p>	

## Also in the Series | MCON 1.2mm



Automotive Connector Caps & Covers (18)

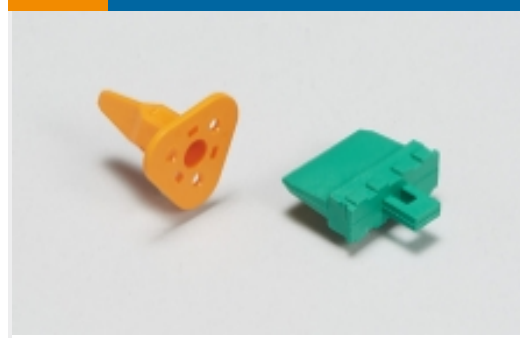

Automotive Connector Locks & Position Assurance (10)



Automotive Housings (328)



Automotive Terminals (96)



Connector Seals & Cavity Plugs (11)



Insertion & Extraction Tools (5)



Other Automotive Connector Accessories (7)

## Customers Also Bought



TE Part #DT06-12SD-C017  
PLG, 12P, BRN, BLOCKED, D

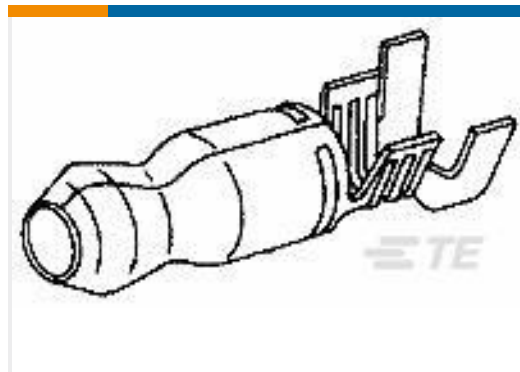

TE Part #62739-1  
SHUR PLUG .180 18-14 AWG PTPBR



TE Part #1823679-1  
AMP MCP, SEALED CONNECTOR HOUSING

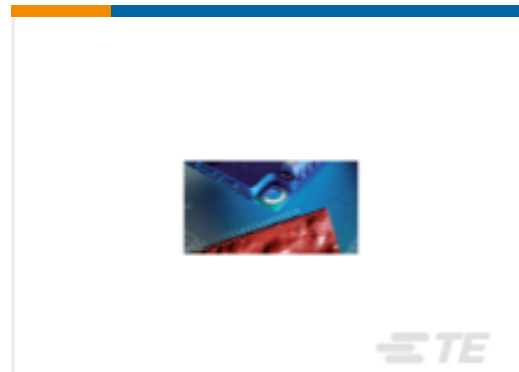

TE Part #CX5483-002  
GURONIC-C500-0-H38400



TE Part #2260321-1  
CAP HOUSING ASSEMBLY 130POS 0.5/1.0



TE Part #2229097-3  
0.50 SERIES CONN 21POS PLUG ASSY



TE Part #2261071-1  
0.5/1.0/2.8 SEALED CONN 186P CAP ASSY



TE Part #2261071-2  
0.5/1.0/2.8 SEALED CONN 186P CAP ASSY



TE Part #7-1372722-1  
CUTTING PLATE



## Documents

### Product Drawings

[6POS, MCON 1.2 LL REC SEALED](#)

English

---

### CAD Files

[3D PDF](#)

3D

Customer View Model

[ENG\\_CVM\\_CVM\\_1-1718646-1\\_F.2d\\_dxf.zip](#)

English

Customer View Model

[ENG\\_CVM\\_CVM\\_1-1718646-1\\_F.3d\\_igs.zip](#)

English

Customer View Model

[ENG\\_CVM\\_CVM\\_1-1718646-1\\_F.3d\\_stp.zip](#)

English

By downloading the CAD file I accept and agree to the [Terms and Conditions](#) of use.

---

### Product Specifications

[Application Specification](#)

English