

RMOD300-UW Series ◊ Plug & Play E-Mobility

300W ◊ Ultra-Wide Input: 18-106VDC

FEATURES

- Ultra wide input voltage range (18-106VDC)
- IP67 protection for selective models
- Operating temperature range: -40°C to +75°C
- Input Reverse Polarity Protection
- Protections: Input UVLO, Output OCL, SCP, OVP, OTP
- Parallel operation capability
- Control ON/OFF function
- 2 years warranty



Dimensions (LxWxH): 190.0 x 76.0 x 44.0mm (7.48 x 2.99 x 1.73 inch)
900g (1.98 lbs)

APPLICATIONS



SAFETY & EMC



DESCRIPTION

The RMOD300-UW On-Board DC-DC converter is ideally for the use in all off-highway electric vehicles. This family is an extremely robust plug & play module with 300 Watts (200W), which generates the isolated $V_{out} = 12.2 / 13.7 / 24.5VDC$ low voltage network from the traction battery level. The ultra wide input voltage range 18-106V covers all common battery voltages in this off-highway segment. Thanks to the waterproof and dust proof housing construction, the devices can directly be connected mechanically and thermally to the chassis (i.e. at any point on the vehicle) and operate reliably even under the most adverse conditions

SELECTION GUIDE

Part Number	Input Voltage Range [VDC]	Output Voltage nom. [VDC]	Output Current max. ⁽¹⁾ [A]	Efficiency typ. ⁽¹⁾ [%]	Output Power max. ⁽²⁾ [W]
RMOD300-80-12.2SUW	18-106	12.2	24	88	300
RMOD300-80-13.7SUW	18-106	13.7	22	89	300
RMOD300-80-24.5SUW	18-106	24.5	12.5	91	300

Note1: Tested at $V_{IN} = 48VDC$ and full load at +25°C ambient

Note2: 300W at $V_{IN} = 27-106VDC$, 200W max. when $V_{IN} < 27VDC$, refer to „Line Derating“

RMOD300-UW Series ◊ Plug & Play E-Mobility

300W ◊ Ultra-Wide Input: 18-106VDC

MODEL NUMBERING

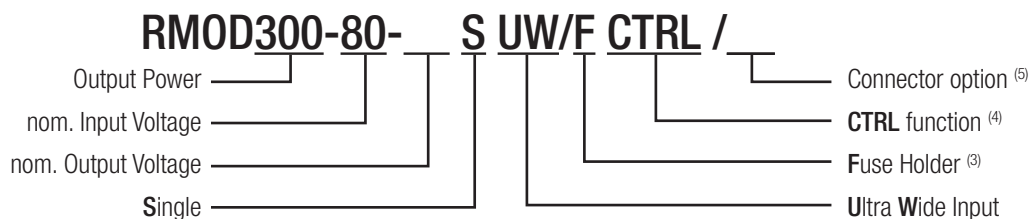

Note3: suffix "/F/MO" = with integrated fuse holder and Molex MINI-FIT SR™ connector

Note4: suffix "/CTRL/MO" = Molex MINI-FIT SR™ connector and CTRL function

Note5: suffix "/MO" = Molex MINI-FIT SR™ connector (IP20 rating only)

suffix "/F/DT" = with integrated fuse holder and Deutsch DTP connector

ORDERING INFORMATION

Model	nom. Output Voltage	Package Type Suffix			
		"/F/MO" (IP20)	"/F/DT" (IP67)	"/CTRL/MO" (IP20)	"/MO" (IP20)
RMOD300-80-12.2SUW	12.2	x	N/A	x	x
RMOD300-80-13.7SUW	13.7	x	x	x	x
RMOD300-80-24.5SUW	24.5	x	x	x	x

x= standard portfolio / N/A= not available

BASIC CHARACTERISTICS (measured @ T_{AMB}= 25°C, nom. V_{IN}, full load and after warm-up unless otherwise stated)

Parameter	Conditions	Min.	Typ.	Max.	
Input Voltage Range		18VDC		106VDC	
Extended Input Voltage	10min max. (refer to „Line Derating“)			126VDC	
Under Voltage Lockout	DC-DC ON	16VDC	17VDC	18VDC	
	DC-DC OFF	14VDC	15VDC	16VDC	
Under Voltage Lockout Hysteresis		1VDC	2VDC	3VDC	
Input Current	V _{IN} = 18VDC			14A	
Inrush Current	V _{IN} = 36VDC			10A	
Quiescent Current	RMOD300-80-12.2SUW and RMOD300-80-13.7SUW	V _{IN} = 24VDC		130mA	240mA
		V _{IN} = 48VDC		60mA	100mA
		V _{IN} = 72/80VDC		45mA	80mA
	RMOD300-80-24.5SUW	V _{IN} = 24VDC		180mA	220mA
		V _{IN} = 48VDC		80mA	120mA
		V _{IN} = 72/80VDC		50mA	100mA
Output Current refer to „Line Derating“	RMOD300-80-12.2SUW	V _{IN} = 18-27VDC			16A
		V _{IN} > 27VDC			24A
	RMOD300-80-13.7SUW	V _{IN} = 18-27VDC			14.5A
		V _{IN} > 27VDC			22A
	RMOD300-80-24.5SUW	V _{IN} = 18-27VDC			8A
		V _{IN} > 27VDC			12.5A
Output Voltage Range	RMOD300-80-12.2SUW	V _{IN} = 18-27VDC	12.13VDC	12.33VDC	12.53VDC
		V _{IN} > 27VDC	12VDC	12.2VDC	12.4VDC
	RMOD300-80-13.7SUW	V _{IN} = 18-27VDC	13.63VDC	13.83VDC	14.03VDC
		V _{IN} > 27VDC	13.5VDC	13.7VDC	13.9VDC
	RMOD300-80-24.5SUW	V _{IN} = 18-27VDC	24.5VDC	24.7VDC	24.9VDC
		V _{IN} > 27VDC	24.3VDC	24.5VDC	24.7VDC
Minimum Load		0%			

RMOD300-UW Series ◊ Plug & Play E-Mobility

300W ◊ Ultra-Wide Input: 18-106VDC



BASIC CHARACTERISTICS (measured @ $T_{AMB}= 25^{\circ}C$, nom. V_{IN} , full load and after warm-up unless otherwise stated)

Parameter	Conditions		Min.	Typ.	Max.
Start-up Time	RMOD300-80-12.2SUW and RMOD300-80-13.7SUW		$V_{IN}= 48VDC$	600ms	800ms
	RMOD300-80-24.5SUW		$V_{IN}= 48VDC$	700ms	1000ms
	all types		$V_{IN}= 72VDC$	850ms	1200ms
	using CTRL function	all types	$V_{IN}= 48/72VDC$	250ms	400ms
Rise Time				60ms	100ms
ON/OFF CTRL (non-isolated to primary side)	DC-DC ON		CTRL Pin to $+V_{IN}$ or floating		
	DC-DC OFF		CTRL Pin to $-V_{IN}$		
Internal Operating Frequency	RMOD300-80-12.2SUW and RMOD300-80-13.7SUW			175kHz	
	RMOD300-80-24.5SUW			160kHz	
Output Ripple & Noise	RMOD300-80-12.2SUW	20MHz BW, peak to peak		50mV	100mV
		r.m.s.		15mV	30mV
	RMOD300-80-13.7SUW and RMOD300-80-24.5SUW	20MHz BW, peak to peak		50mV	100mV
		r.m.s.		20mV	50mV
Reflected Back Ripple Current	$V_{IN}= 48VDC$	peak to peak			0.6A
Maximum Capacitive Load	ESR>10m Ω	RMOD300-80-12.2SUW and RMOD300-80-13.7SUW			5000 μF
		RMOD300-80-24.5SUW			2000 μF

Line Derating

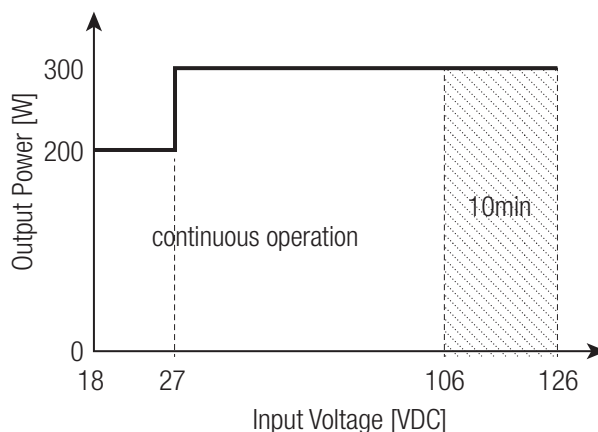

RMOD300-80-12.2SUW

Efficiency vs. Load
($V_{IN}= 18-27VDC$)

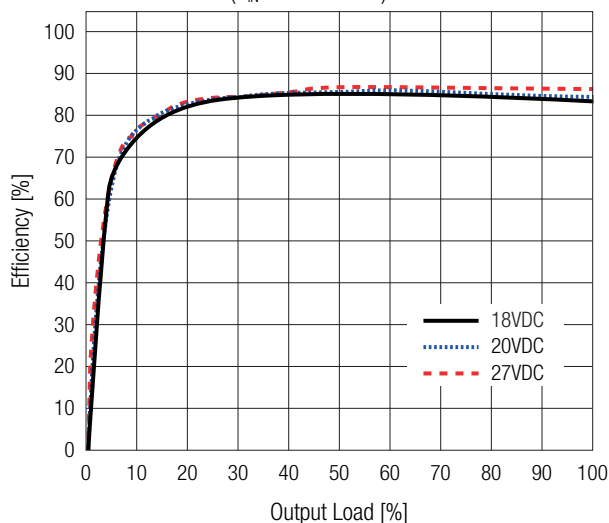

Efficiency vs. Load
($V_{IN}= 27-106VDC$)

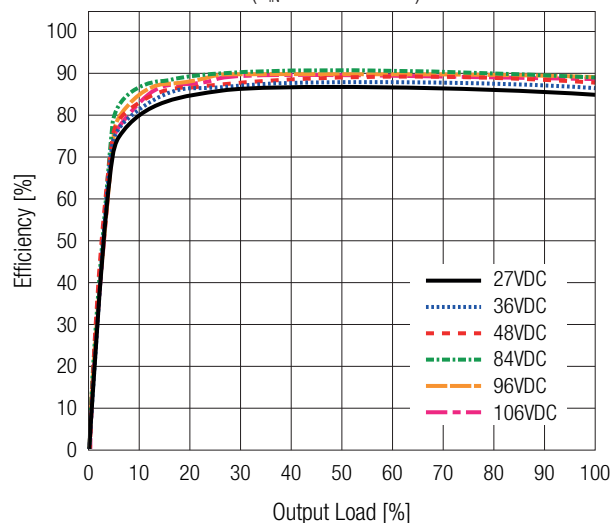

BASIC CHARACTERISTICS (measured @ $T_{AMB} = 25^{\circ}C$, nom. V_{IN} , full load and after warm-up unless otherwise stated)

RMOD300-80-12.2SUW

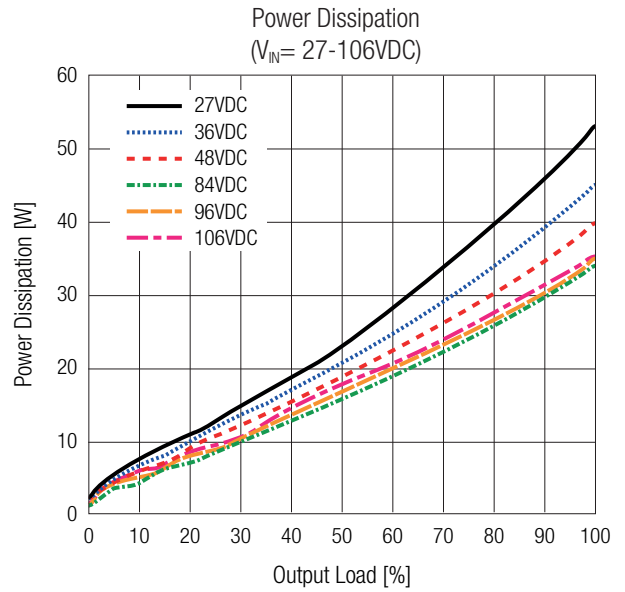
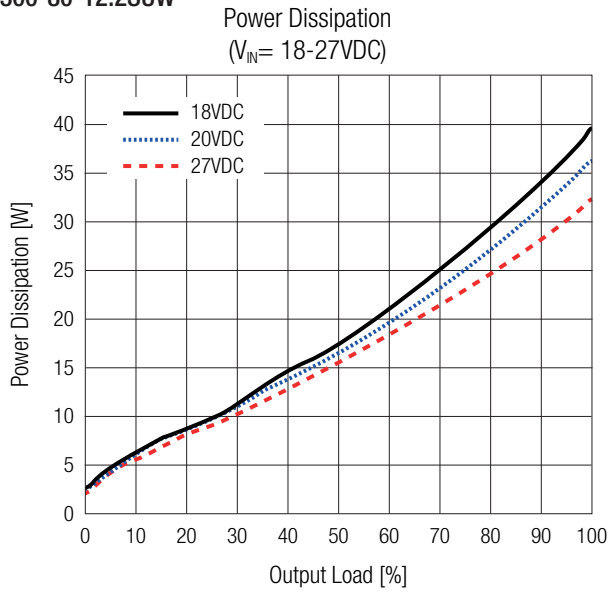

RMOD300-80-24.5SUW

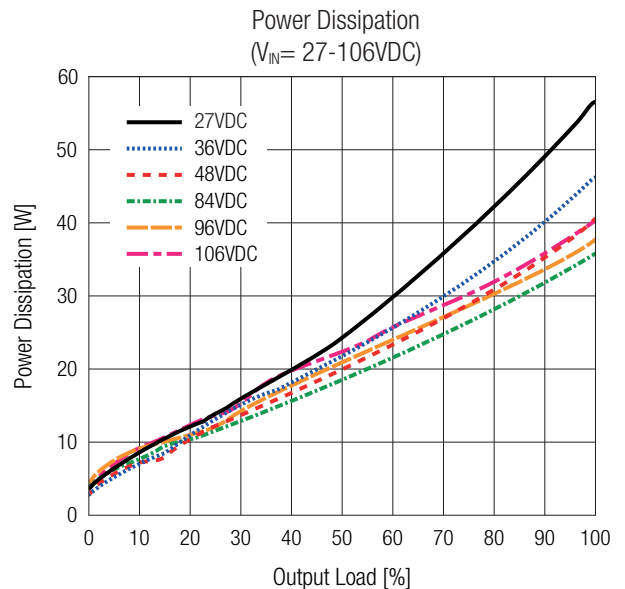
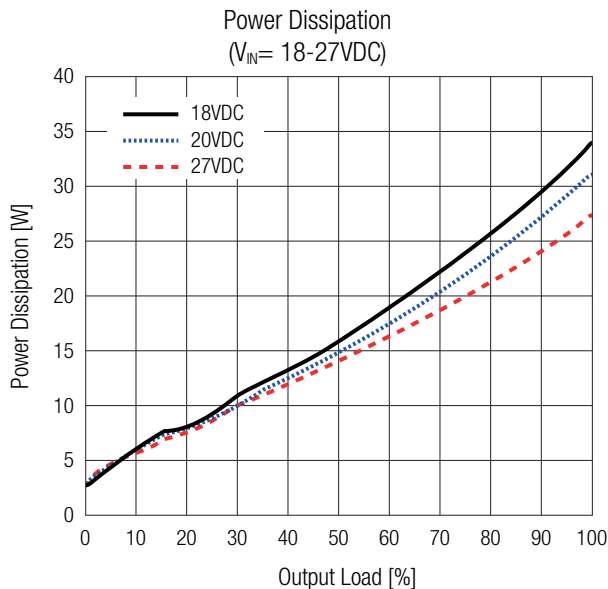
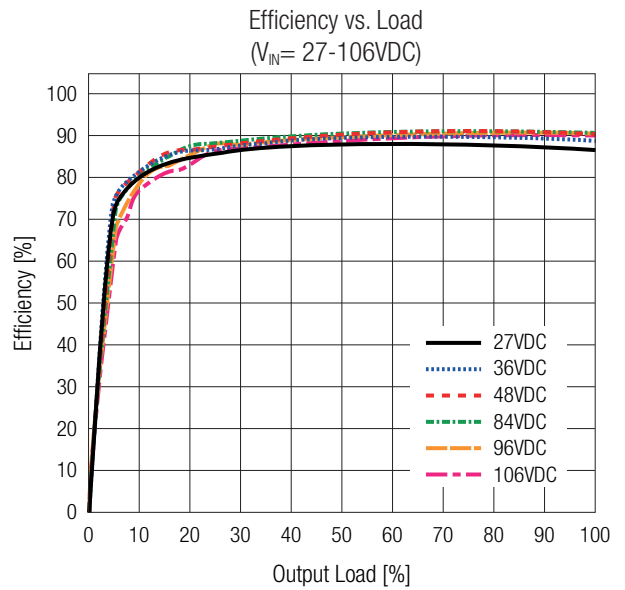
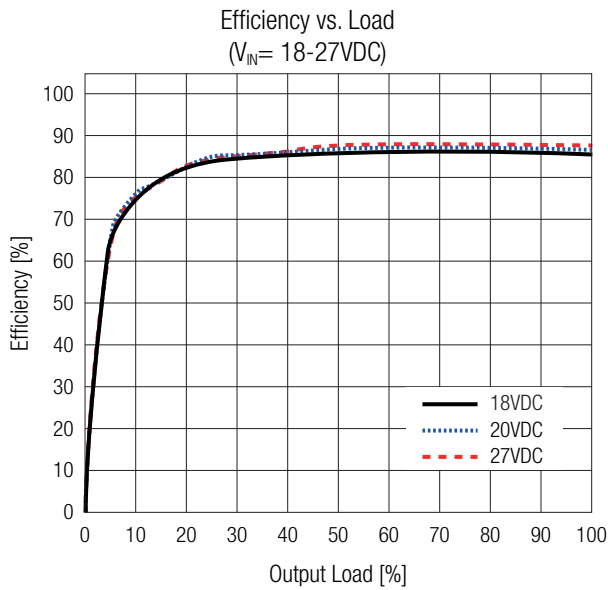

RMOD300-UW Series ◊ Plug & Play E-Mobility

300W ◊ Ultra-Wide Input: 18-106VDC



REGULATIONS (measured @ TAMB= 25°C, nom. VIN, full load and after warm-up unless otherwise stated)

Parameter	Conditions		Value
Output Accuracy			±0.3% max.
Current Share Accuracy	VIN= 48VDC, full load		6% typ. / 10% max.
Line Regulation	low line to high line, full load		±0.1% max.
Load Regulation	10-100% load		3.0% typ.
Transient Response	25% load step change	RMOD300-12.2SUW	100mV typ. / 200mV max.
		RMOD300-13.7SUW and RMOD300-24.5SUW	150mV typ. / 250mV max.

RMOD300-80-12.2SUW

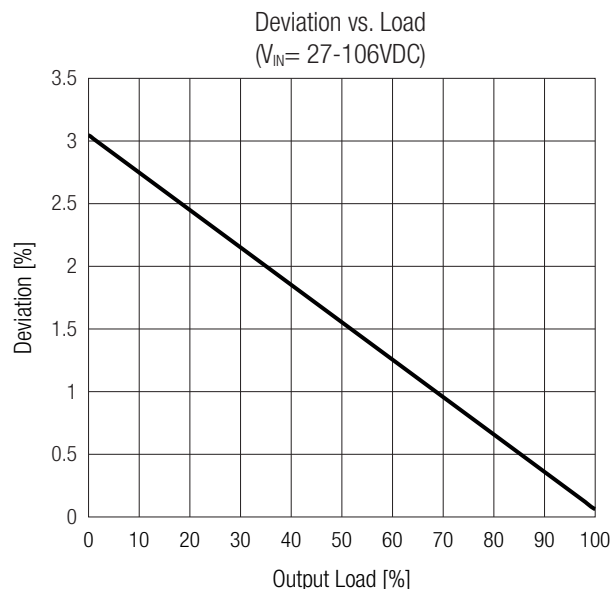
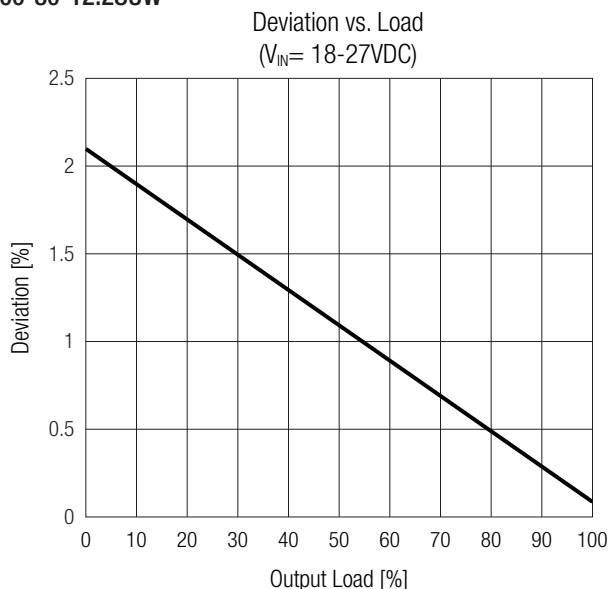

RMOD300-80-24.5SUW

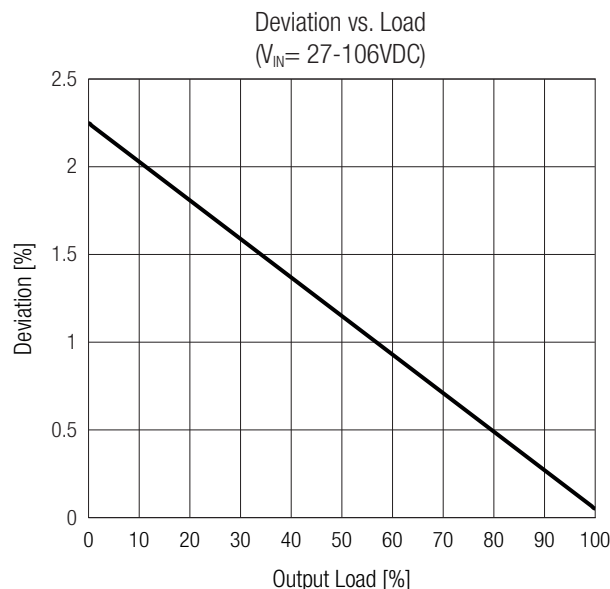
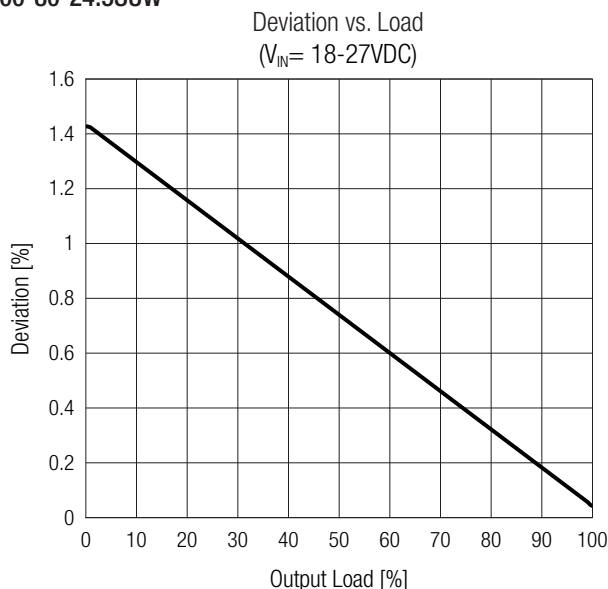

PROTECTIONS (measured @ TAMB= 25°C, nom. VIN, full load and after warm-up unless otherwise stated)

Parameter	Conditions	Value
Internal Input Fuse	Ø6.35mm x 31.75mm ("F/DT" and "F/MO" only)	250VDC/30A fast-acting fuse
Short Circuit Protection (SCP)		hiccup mode, auto recovery
Input Reverse Polarity Protection		-106VDC max.
Over Voltage Protection (OVP)	RMOD300-12.2SUW	13-17VDC; hiccup mode, auto recovery
	RMOD300-13.7SUW	15-18VDC; hiccup mode, auto recovery
	RMOD300-24.5SUW	26-28VDC; hiccup mode, auto recovery
Over Current Protection (OCP)		current limitation, automatic restart

PROTECTIONS (measured @ T_{AMB}= 25°C, nom. V_{IN}, full load and after warm-up unless otherwise stated)

Parameter	Conditions		Value
Over Temperature Protection (OTP)	measured on NTC	RMOD300-12.2SUW and RMOD300-24.5SUW	118°C, latch mode
		RMOD300-13.7SUW	108°C, latch mode
Isolation Voltage ⁽⁶⁾	I/P to O/P and I/P to case		2250VDC
	O/P to case		550VDC
Isolation Resistance	I/P to O/P		10MΩ min.
Isolation Capacitance	I/P to O/P	RMOD300-12.2SUW	10000pF max.
		RMOD300-13.7SUW	9000pF max.
		RMOD300-24.5SUW	7000pF max.
Insulation Grade			basic

Note6: For repeat Hi-Pot testing, reduce the time and/or the test voltage

ENVIRONMENTAL (measured @ T_{AMB}= 25°C, nom. V_{IN}, full load and after warm-up unless otherwise stated)

Parameter	Conditions		Value
Operating Ambient Temperature Range	with derating, refer to „Thermal Consideration“		-40°C to +75°C
Operating Altitude			5000m
Operating Humidity			95% RH max.
Pollution Degree			PD2
IP Rating	electronic part is encapsulated in IP67 level for all versions	"I/F/DT" type	IP67
		others	IP20
Shock	50G, 3 planes		according to IEC 60068-2-27
Vibration	10G, 15~200Hz, 3 planes		according to IEC 60068-2-6
MTBF	Telcordia SR332 Issue 3, Method I Reliability Prediction, T _{AMB} = 25°, 80% load	RMOD300-80-12.2SUW	520 x 10 ³ hours
		RMOD300-80-13.7SUW	740 x 10 ³ hours
		RMOD300-80-24.5SUW	675 x 10 ³ hours

Thermal Consideration

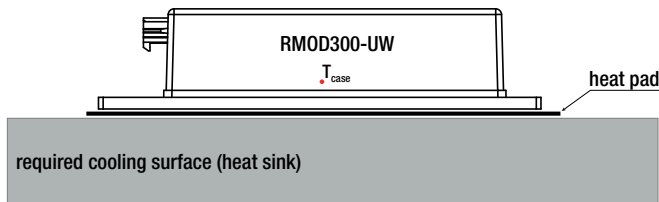

The module can be used in enclosed applications, as long as the cooling is sufficient to keep the baseplate temperature below 70°C. The surrounding temperature should not exceed 75°C.

T_{amb}
natural convection 0.1m/s

RMOD300-80-12.2SUW

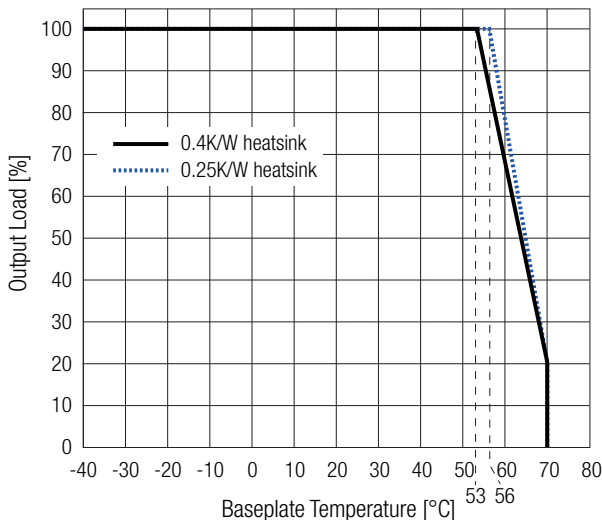

RMOD300-80-24.5SUW

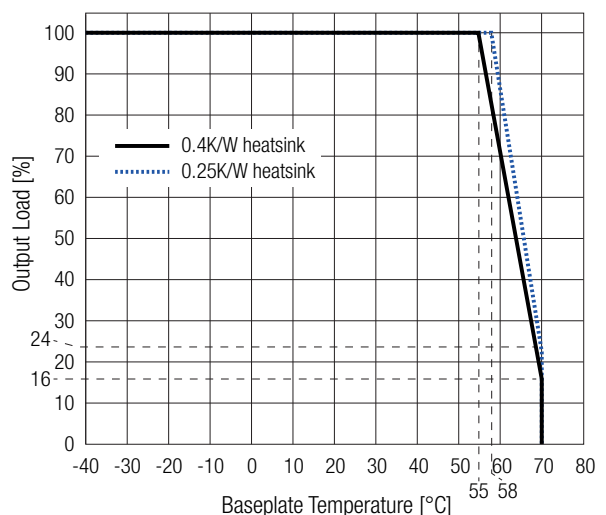

RMOD300-UW Series ◊ Plug & Play E-Mobility

300W ◊ Ultra-Wide Input: 18-106VDC



SAFETY & CERTIFICATIONS

Certificate Type (Safety)	Report Number	Standard
Audio/Video, information and communication technology equipment - Part1: Safety requirements 2nd Edition	E224736	UL62368-1:2014 2nd Edition
		CAN/CSA-C22.2 No. 62368-1-14 2nd Edition
Audio/video, information and communication technology equipment. Safety requirements		EN62368-1:2014+A11:2017
RoHS2		RoHS 2011/65/EU + AM2015/863

EMC Compliance according to EN12895 (valid for all models)	Conditions	Standard / Criterion
Industrial trucks - Electromagnetic compatibility		EN12895:2015
Electromagnetic compatibility (EMC) - Part 6-3: Generic standards - Emission standard for residential, commercial and light-industrial environments		EN61000-6-3:2007+A1:2011
ESD Electrostatic discharge immunity test	Air: ±15kV Contact: ±8kV	IEC61000-4-2:2008, Criteria A EN61000-4-2:2009, Criteria A
Radiated, radio-frequency, electromagnetic field immunity test	20V/m (27-1000MHz), 3V/m (1000-2000MHz), 1V/m (2000-2700MHz)	IEC/EN61000-4-3:2006+A12:2010, Criteria A
Power Magnetic Field Immunity	DC 1000A/m, AC 50Hz 30A/m	IEC61000-4-8:2009, Criteria A EN61000-4-8:2010, Criteria A

EMC Compliance according to EN55014-2 (except RMOD300-80-12.2SUW)	Conditions	Standard / Criterion
Electromagnetic compatibility - Requirements for household appliances, electric tools and similar apparatus - Part 2: Immunity		EN55014-2:1997+A2:2008
ESD Electrostatic discharge immunity test	Contact: ±2, 4kV	IEC61000-4-2:2008, Criteria A EN61000-4-2:2009, Criteria A
ESD Electrostatic discharge immunity test	Air: ±2, 4, 8kV Contact: ±2, 4kV	IEC61000-4-2:2008, Criteria A EN61000-4-2:2009, Criteria A
Radiated, radio-frequency, electromagnetic field immunity test	3V/m (80-1000MHz)	IEC/EN61000-4-3:2006+A12:2010, Criteria A
Fast Transient and Burst Immunity (valid for RMOD300-80-24.5SUW)	DC Power Port ±1kV	IEC/EN61000-4-4:2012, Criteria A
Fast Transient and Burst Immunity (valid for RMOD300-80-13.7SUW)	DC Power Port ±0.5kV	IEC/EN61000-4-4:2012, Criteria A
Immunity to conducted disturbances, induced by radio-frequency fields	1Vrms (0.15-80MHz)	IEC61000-4-6:2008, Criteria A EN61000-4-6:2009, Criteria A

EMC Compliance according to EN55011 (except RMOD300-80-12.2SUW)	Conditions	Standard / Criterion
Industrial, scientific and medical equipment - Radio-frequency disturbance characteristics - Limits and methods of measurement		EN55011:2009+A1:2010, Class A

DIMENSION & PHYSICAL CHARACTERISTICS

Parameter	Type	Value
Material	case	polycarbonate
	baseplate	aluminum
Dimension (LxWxH)		190.0 x 76.0 x 44.0mm 7.48 x 2.99 x 1.73 inch
Weight		900g typ. 1.98 lbs

DIMENSION & PHYSICAL CHARACTERISTICS

Dimension Drawing (mm)
MOLEX Connector

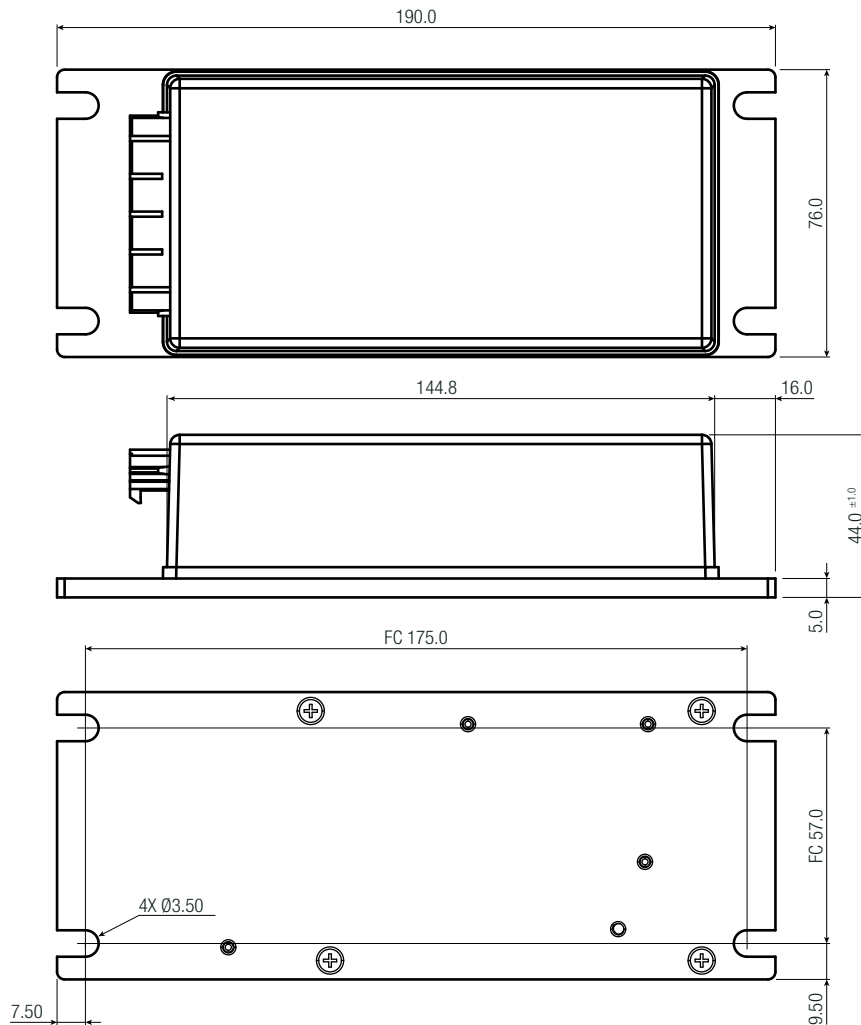
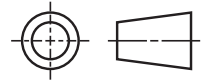

MOLEX Connector without CTRL function "/MO"

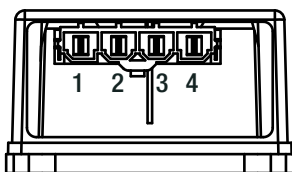

Connector Information
MOLEX 42819-4213

Pin #	Function	Compatible Connector
1	-V _{OUT}	Housing
2	+V _{OUT}	Molex 42816-0412
3	-V _{IN}	Crimp Terminal
4	+V _{IN}	Molex 42815-0042

FC= fixing center

MOLEX Connector with CTRL function "/CTRL/MO"

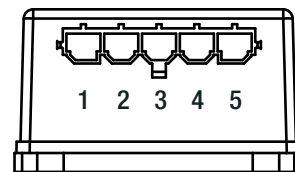

Connector Information
MOLEX 42819-5213

Pin #	Function	Compatible Connector
1	-V _{OUT}	Housing
2	+V _{OUT}	Molex 42816-0512
3	-V _{IN}	Crimp Terminal
4	+V _{IN}	Molex 42815-0042
5	CTRL	

FC= fixing center

Tolerance:
xx.x= ±0.5mm
xx.xx= ±0.25mm

DIMENSION & PHYSICAL CHARACTERISTICS

Dimension Drawing (mm)

MOLEX Connector with Fuse without CTRL function "/F/MO"

Connector Information MOLEX 42819-4213

Pin #	Function	Compatible Connector
1	-V _{OUT}	Housing
2	+V _{OUT}	Molex 42816-0412
3	-V _{IN}	Crimp Terminal
4	+V _{IN}	Molex 42815-0042

FC= fixing center

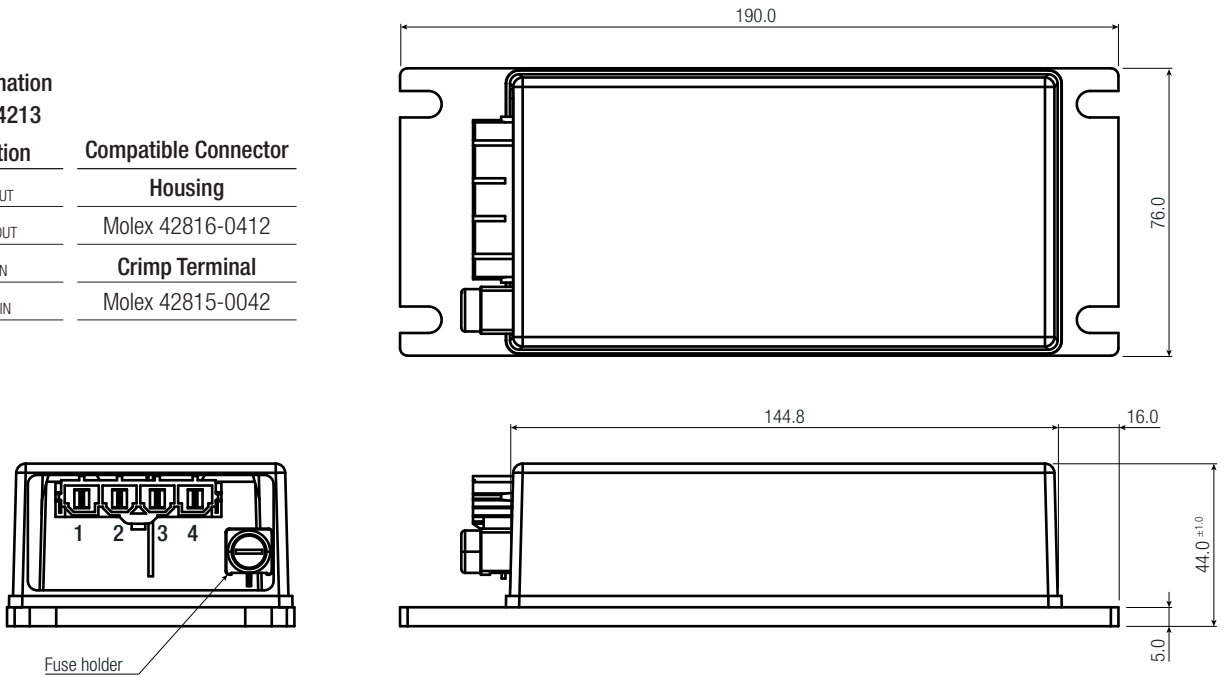

Dimension Drawing (mm)

DT Connector with Fuse without CTRL function "/F/DT"

Connector Information DT: DTP04-4P

Pin #	Function
1	-V _{OUT}
2	+V _{OUT}
3	-V _{IN}
4	+V _{IN}

FC= fixing center

Compatible Connector

Housing
DTP06-4S
Crimp Terminal
0462-203-12141
Wedge Lock
WP-4S

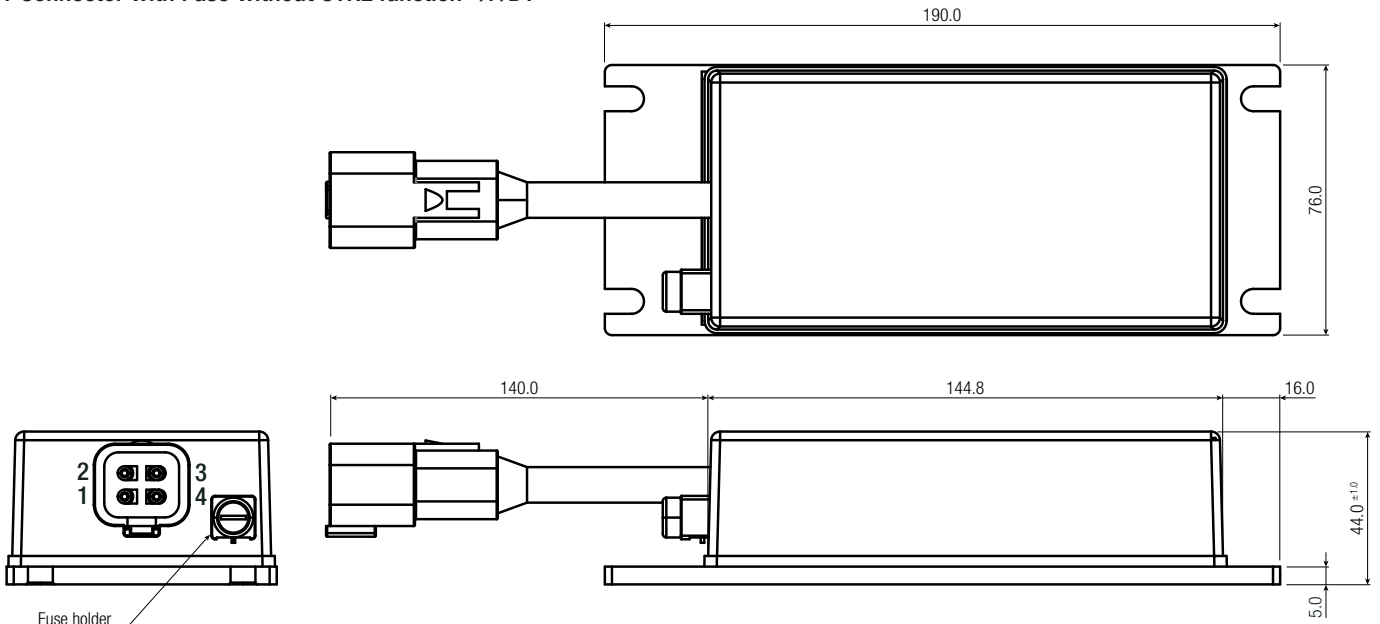

Tolerance:
xx.x= ±0.5mm
xx.xx= ±0.25mm

INSTALLATION & APPLICATION

Parallel Operation

Parallel operation is possible with all combinations DC/DC converter versions providing they have the same rated output voltage.
 Use the same wire length for each power supply (star connection) and energize all units at the same time to avoid triggering overload protection.
 For operation with more than two power supplies in parallel operation, please contact RECOM technical support for advice.

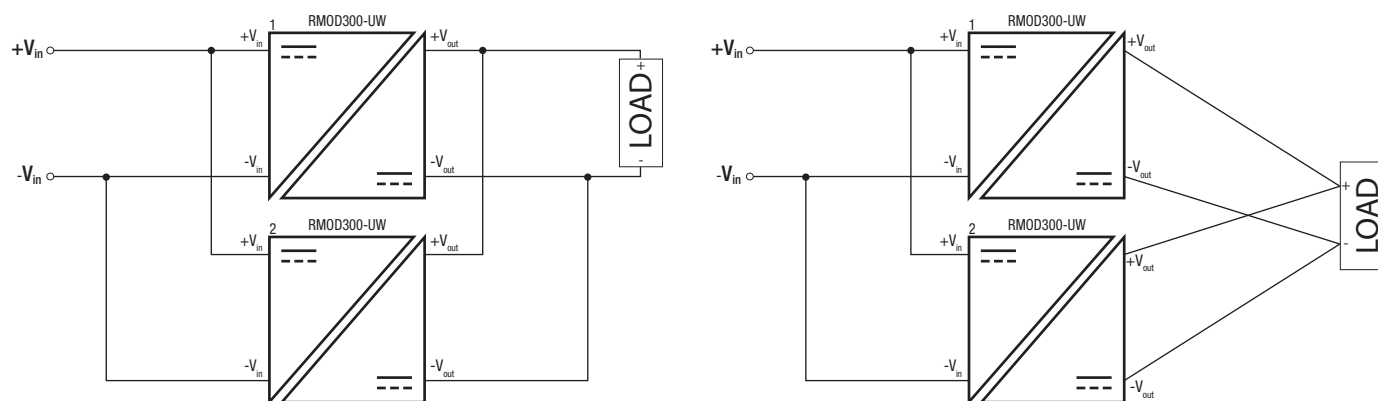

PACKAGING INFORMATION

Parameter	Type		Value
	cardboard box	others	
Packaging Dimension (LxWxH)		"/F/DT" Version	490.0 x 375.0 x 126.0mm
		others	495.0 x 295.0 x 214.0mm
Packaging Quantity		"/F/DT" Version	10pcs
		others	7pcs
Storage Temperature Range			-40°C to +125°C
Storage Humidity		non-condensing	95% RH max.

The product information and specifications may be subject to changes even without prior written notice. The product has been designed for various applications; its suitability lies in the responsibility of each customer. The products are not authorized for use in safety-critical applications without RECOM's explicit written consent. A safety-critical application is an application where a failure may reasonably be expected to endanger or cause loss of life, inflict bodily harm or damage property. The applicant shall indemnify and hold harmless RECOM, its affiliated companies and its representatives against any damage claims in connection with the unauthorized use of RECOM products in such safety-critical applications.